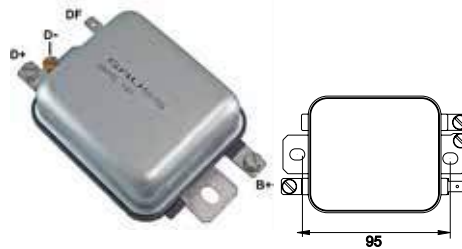

ELECTRICAL SPARE PART | PIEZA ELÉCTRICA

VOLTAGE REGULATOR | REGULADOR DE VOLTAJE

BOSCH
GA002

FEATURES / CARACTERÍSTICAS: 14V / 30A 'A' Circuit

REPLACES / REEMPLAZA:

Bosch: 9 190 083 002, 9 190 089 099, 1197 BE3 002; **Magneti Marelli:** RT510065

APPLICATION / APLICACIÓN:

VW: Brasília, Kombi, Karman-guia, Sedan, Gol, Puma, Saveiro - Equipped with dynamo

ALTERNATOR / ALTERNATOR:

BOSCH: 0 100 082 002, 0 100 082 009, 0 100 082 010

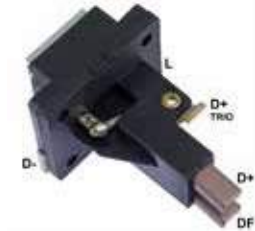
BOSCH
GA999

FEATURES / CARACTERÍSTICAS: 14V / 55A 'A' Circuit

REPLACES / REEMPLAZA:

Bosch: 9 190 087 003; **Cargo:** 238936; **WAI/Transpo:** IB003; **Magneti Marelli:** RT510250

APPLICATION / APLICACIÓN:

VW: Brasília, Kombi, Sedan, Gol, Saveiro (w/ AC) - Equipped with alternator

ALTERNATOR / ALTERNATOR:

BOSCH: 9 120 080 041, 9 120 080 061, 9 120 080 072, 9 120 080 090, F 000 LD0 108, 9 120 080 122

RECTIFIER:

GA1595

BOSCH
GA003

FEATURES / CARACTERÍSTICAS: 14V / 55A 'A' Circuit

REPLACES / REEMPLAZA:

Bosch: 9 190 087 003; **Regitar:** VRB211; **Cargo:** 238936; **WAI/Transpo:** IB359; **AS Poland:** ARE0100; **Magneti Marelli:** RT510066

APPLICATION / APLICACIÓN:

VW: Brasília, Kombi, Sedan, Gol, Saveiro (w/ AC) - Equipped with alternator

ALTERNATOR / ALTERNATOR:

BOSCH: 9 120 080 041, 9 120 080 061, 9 120 080 072, 9 120 080 090, F 000 LD0 108, 9 120 080 122

RECTIFIER:

GA1595

BOSCH
GA016 // NEW //

FEATURES / CARACTERÍSTICAS: 14V, 'A' Circuit

REPLACES / REEMPLAZA:

Mobiletron: VR-F110A; **Regitar:** VRF110A; **Cargo:** 130613; **Transpo:** IX4004; **Era:** 215785

APPLICATION / APLICACIÓN:

AIFO ENGINE - MARINE: 8031 2.8L 1979>1983, 8035 2.6L 1973>1983, 8045 3.5L 1973>1981, 8065 5.2L 1973>1981, CO 31 4.9L 1971>1981, CO 31 5.4L 1971>1981; **IVECO:** Daily 35 2400 1978>1983; **LANCIA:** Montecarlo 2000 1976>1980; **FIAT:** 124 L4 1.2L 1968>1969, 124 L4 1.4L 1968>1973, 124 L4 1.6L 1972>1973, 124 L4 1.8L 1974>1975, 131 1300/1600 1974>1977, 132 1600/2000 1974>1977

ALTERNATOR / ALTERNATOR:

ALFA ROMEO: 116760506000, 116760506000;

FIAT: 4152101, 4152612, 4181511, 4222696, 4222697, 4242730, 4263584, 4263983, 4268914, 4306041, 4306700, 4378710, 4380114, 4392832, 4396883, 4474557, 4474558, 4474566, 4474581, 4474704, 4474904, 4474933, 4475035, 4475036, 4476376, 77025410

BOSCH
GA505 // NEW //

FEATURES / CARACTERÍSTICAS: 28V, S. POINT: 27,9V 'B' Circuit

REPLACES / REEMPLAZA:

Bosch: 9 190 333 704; **Magneti Marelli:** 63408305, 63408306, 64808102, 64808108, RTT110C, RTT110CCJ, RTT110J;

Valeo: 505054; **Transpo:** IX4005; **Cargo:** 130610; **Mobiletron:** VR-F110B

APPLICATION / APLICACIÓN:

Aifo: CO 31 4.9/5.4 1971>1981;

Fiat: Allis 1969>1985

ALTERNATOR / ALTERNATOR:

MAGNETI MARELLI: 063304075010, 063304400010, 063304401010, 063304420010, 63304000, 63304001, 63304020, 63304075, 63304081, 63304082, 63304087, 63304090, 63304100, 63304120, 63304400, 63304401, 63304410, 63304420, 63304807

BOSCH
GA017

FEATURES / CARACTERÍSTICAS: 28V / 55A 'A' Circuit

REPLACES / REEMPLAZA:

...

APPLICATION / APLICACIÓN:

Water Cool Vehicles with **VW** engine and 28V Alternator

ALTERNATOR / ALTERNATOR:

'A' Circuit 28V Alternator

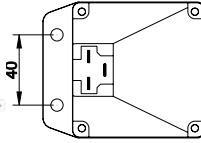
BOSCH
GA004

FEATURES / CARACTERÍSTICAS: 28V / 65A 'B' Circuit, 3 Terminals

REPLACES / REEMPLAZA:

Bosch: 0 192 033 001, 0 192 033 002, 0 192 033 004, 0 192 033 006; **Regitar:** VRB199-3; **Cargo:** 130677; **WAI/Transpo:** IB033; **Huco/Hitachi:** 130311

APPLICATION / APLICACIÓN:

SCANIA: Marine engine Dn11, Ds11, Ds14, platform for bus K, S 112;

CATERPILLAR: Motor Graders, Tractors D4E, D6D;

MAXION: Tractors MF 265E, 265-4

ALTERNATOR / ALTERNATOR:

BOSCH: 9 120 080 062, 9 120 080 071, 9 120 080 074, 9 120 080 082

RECTIFIER:

GA1001 / GA1003

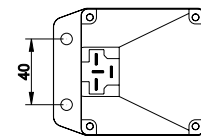
BOSCH
GA005

FEATURES / CARACTERÍSTICAS: 28V / 55A 'B' Circuit, 4 Terminals

REPLACES / REEMPLAZA:

Bosch: 0 192 033 003, 0 192 033 005; **Regitar:** VRB199-4; **Cargo:** 130678; **WAI/Transpo:** IB034; **Huco/Hitachi:** 130312; **Magneti Marelli:** RT510068

APPLICATION / APLICACIÓN:

SCANIA: Trucks L, LS, LT 110, 110S, 111, 111S, LS, LKS 140, 141, 142, T112, R112, Chassi p/ Bus BR 116S, Marine engine, Ind. and Geradores Dn11, Ds11, Ds14; **VOLVO:** Truck N 10, N12, platform for bus B58E; **CUMMINS:** Engines N, NT, NTA, NTTA 855.

ALTERNATOR / ALTERNATOR:

BOSCH: 9 120 080 088, 9 120 080 109, 9 120 080 110, 9 120 080 124, 9 120 080 125

RECTIFIER:

GA1001 / GA1003

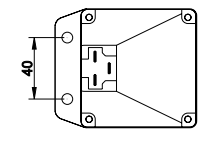
BOSCH
GA006

FEATURES / CARACTERÍSTICAS: 14V / 55A 'B' Circuit, 3 Terminals

REPLACES / REEMPLAZA:

...

APPLICATION / APLICACIÓN:

CATERPILLAR: Machinery and Equipmet with Alternator Bosch 14V.

ALTERNATOR / ALTERNATOR:

14V Bosch Alternators

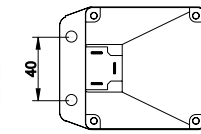
BOSCH
GA010

FEATURES / CARACTERÍSTICAS: 28V / 100A 'B' Circuit, 3 Terminals

REPLACES / REEMPLAZA:

...

APPLICATION / APLICACIÓN:

Heavy Duty Line, alternators 28V - 100A / Línea pesada (HD) para alternadores 28V hasta 100A.

ALTERNATOR / ALTERNATOR:

28V 100A "B" Circuit Alternators

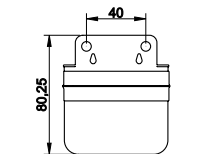
BOSCH
GA001

FEATURES / CARACTERÍSTICAS: 14V / 55A 'B' Circuit

REPLACES / REEMPLAZA:

Bosch: 9 190 087 011, 9 190 085 001, 9 190 087 006; **Regitar:** VRB190; **Cargo:** 130675; **WAI/Transpo:** IB305; **Huco/Hitachi:** 130216, 2500216; **Magneti Marelli:** RT510064

APPLICATION / APLICACIÓN:

VW: Variant, TL; **MERCEDES BENZ:** Trucks, Bus and Engines Stationary; **TOYOTA:** Bandeirante; **VALMET:** Tractors 118, 138-4

(until 85), 68, 78, 88, 62ID, 65ID; **MAXION:** Tractors MF 235, 270, 275, 275-4, 290, 290-4, 296, 296-4, 50x, 55x, 55r, 65x, 86, 95i; **JI**

CASE: Tractors W18, 2470, Bulldozers 80P, 80CR; **AGRALE:** Trucks TR 1100, 1600, 1600D, Tractors 4200, 4300 (until 05.85), 440 (M790);

FIAT: Alfa 2300B, 2300 Ti, D.Panorama, 147, Fiorino.

ALTERNATOR / ALTERNATOR:

BOSCH: 9 120 080 012, 9 120 080 020, 9 120 080 022, 9 120 080 031, 9 120 080 045, 9 120 080 054, 9 120 080 101, 9 120 080 056,

9 120 080 057, 9 120 080 060, 9 120 080 066, 9 120 080 079, 9 120 080 083, 9 120 080 084, 9 120 080 091, 9 120 080 102,

9 120 080 106, 9 120 080 107, 9 120 080 111, 9 120 080 123, 9 120 080 138, 9 120 450 053, 9 120 450 058, 9 120 456 038

RECTIFIER:

GA1374 / GA1006

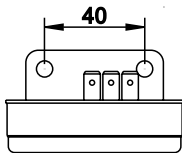
BOSCH
GA011

FEATURES / CARACTERÍSTICAS: 14V / 55A 'B' Circuit

REPLACES / REEMPLAZA:

Bosch: 9 190 085 001, 9 190 087 011; **Regitar:** VRB191; **Cargo:** 136325; **WAI/Transpo:** IB301A; **Huco/Hitachi:** 130216; **Magneti Marelli:** RT510073

APPLICATION / APLICACIÓN:

VW: Variant, TL; **MERCEDES BENZ:** Trucks, Bus and Engines Stationary; **TOYOTA:** Util. Bandeirante; **VALMET:** Trat. 118, 138-4 (until 85), 68, 78, 88, 62ID, 65ID; **MAXION:** Tractors MF 235, 270, 275, 275-4, 290, 290-4, 296, 296-4, 50x, 55x, 55r, 65x, 86, 95i; **JI CASE:** Tractor W18, 2470. Escavador. 80P, 80CR; **AGRALE:** Trucks TR 1100, 1600, 1600D. Tractors 4200, 4300 (until 05.85), 440 (M790); **FIAT:** Alfa 2300B, 2300 TI, D.Panorama, 147, Fiorino.

ALTERNATOR / ALTERNATOR:

BOSCH: 9 120 080 012, 9 120 080 020, 9 120 080 054, 9 120 080 101, 9 120 080 022, 9 120 080 031, 9 120 080 045, 9 120 080 056, 9 120 080 057, 9 120 080 060, 9 120 080 066, 9 120 080 079, 9 120 080 083, 9 120 080 084, 9 120 080 091, 9 120 080 102, 9 120 080 107, 9 120 080 111, 9 120 080 123, 9 120 080 138, 9 120 456 038

RECTIFIER:

GA1374 / GA1006

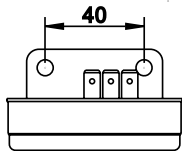
BOSCH
GA012

FEATURES / CARACTERÍSTICAS: 28V / 45A 'B' Circuit

REPLACES / REEMPLAZA:

Bosch: 9 190 085 000

APPLICATION / APLICACIÓN:

MERCEDES BENZ: Trucks 1924 (OM 355-6), 1924A, 2624A (OM 355-6 A) (until 04.82), Trucks 1929 (OM 355-6 A), 1932 (OM 355-6 LA) (until 05.85), Plat. and Bus O 370 R, RS, RSD (OM 355-5,6,6 A, 6 LA) (until 05.85);

FIAT: Trucks Fiat 70, 80, 100, 130, 140, 180, 190, FNM 210;

KOMATSU: Tractors D60A, E, F, D65A, E;

FIAT ALLIS: Tractor Ad78;

CATERPILLAR: Motor Grader 3306, Wheel Loader 930 and 966, Bulldozer D4E and D6E, All (12.80>).

ALTERNATOR / ALTERNATOR:

BOSCH: 9 120 080 039, 9 120 080 049, 9 120 080 055, 9 120 080 058, 9 120 080 064, 9 120 080 067, 9 120 080 069, 9 120 080 073, 9 120 080 075, 9 120 080 085, 9 120 080 086, 9 120 080 094, 9 120 080 103, 9 120 080 104, 9 120 080 105, 9 120 080 106, 9 120 080 113, 9 120 080 146, 9 120 080 150, 9 120 080 189

RECTIFIER:

GA1374

BOSCH
GA013

FEATURES / CARACTERÍSTICAS: 28V / 45A 'B' Circuit

REPLACES / REEMPLAZA:

Bosch: 9 190 085 000; **Regitar:** VRB224B; **Cargo:** 130610; **WAI/Transpo:** IB307

APPLICATION / APLICACIÓN:

MERCEDES BENZ: Trucks 1924 (OM 355-6), 1924A, 2624A (OM 355-6 A) until 04.82, Trucks 1929 (OM 355-6 A), 1932 (OM 355-6 LA) until 05.85, Plat. and Bus O 370 R, RS, RSD (OM 355-5,6,6 A, 6 LA) until 05.85;

CATERPILLAR: Motor Grader 3306, Wheel Loader 930 and 966, Bulldozer D4E and D6E, All until 12.80;

KOMATSU: Tractors D60A, D60E, D60F, D65A, D65E;

FIAT ALLIS: Tractor Ad78;

FIAT: Trucks Fiat 70, 80, 100, 130, 140, 180, 190, FNM 210.

ALTERNATOR / ALTERNATOR:

BOSCH: 9 120 080 039, 9 120 080 049, 9 120 080 055, 9 120 080 058, 9 120 080 064, 9 120 080 067, 9 120 080 069, 9 120 080 073, 9 120 080 075, 9 120 080 085, 9 120 080 086, 9 120 080 094, 9 120 080 103, 9 120 080 104, 9 120 080 105, 9 120 080 106, 9 120 080 113, 9 120 080 146, 9 120 080 150, 9 120 080 189

RECTIFIER:

GA1374

BOSCH
GA366

FEATURES / CARACTERÍSTICAS: Capacitor

REPLACES / REEMPLAZA:

Bosch: 6 004 MR0 000, F 00M 145 250, F 00M145 426, F 00M 145 477 ; **Cargo:** 235772; **WAI/Transpo:** 399105; **AS Poland:** ARE0105

APPLICATION / APLICACIÓN:

Chrysler: PT Cruiser, Dodge RAM 99-2000, Jeep Cherokee 2001->, Dakota 2.5L 2002-2006

ALTERNATOR:

BOSCH: 0 124 515 084, 0 124 615 018, 0 124 425 001, 0 124 515 115, 0 124 525 002, 0 124 525 003, 0 124 525 004, 0 124 525 005, 0 124 525 007, 0 124 615 032

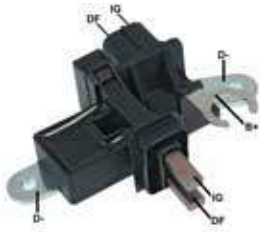
BOSCH
GA367

FEATURES / CARACTERÍSTICAS: Capacitor

REPLACES / REEMPLAZA:
Bosch: F 00M 145 264; **Cargo:** 235615; **WAI/Transpo:** 399106; **AS Poland:** ARE0153

APPLICATION / APLICACIÓN:
Chrysler: Dodge RAM Pick-ups 5.9L(359) L6 (Diesel) 2006-08, Dodge Durango 5.7L(345) V8 2004, Dodge RAM Pick-ups 5.7L(345) V8 2003-2006

ALTERNATOR:
BOSCH: 0 124 525 105, 0 124 525 154, 0 124 525 006, 0 124 525 041, 0 124 525 051, 0 124 525 106; **CHRYSLER:** 048014 75AA, 048014 75AB

BOSCH
GA018

FEATURES / CARACTERÍSTICAS: 28V / 55A 'A' Circuit

REPLACES / REEMPLAZA:
Bosch: 9 190 087 018, 9 190 087 014, 0 192 053 006, 1986 AE0 007; **Regitar:** VRB198; **Cargo:** 130960; **WAI/Transpo:** IB374; **AS Poland:** ARE0027, **Huco/Hitachi:** 130525; **Magneti Marelli:** RT510077

APPLICATION / APLICACIÓN:
MERCEDES BENZ: Trucks, Bus, Stationary and Marit. with alt. 28V;

VOLVO: Trucks N10 (TD101 F/G), N12 (TD121 F/G), NL 12-400, NL 10-280, NL 10-340, N10 (TD100G), N12 (TD121GA) after 03.84, Bus



- Metallic body – BETTER HEAT DISSIPATION;
- Rotor short circuit protection;
- Better performance in relation of current and working temperature;

- Cuerpo de metal – MEJOR DISIPACIÓN DEL CALOR
- Protección de cortocircuito del rotor;
- Mejora del rendimiento relativo a corriente y temperatura de trabajo;

ALTERNATOR / ALTERNATOR:
BOSCH: 0 120 469 527, 0 120 469 691, 0 120 469 752, 0 120 469 753, 0 120 488 125, 0 120 488 232, 0 120 489 053, 0 120 489 060, 0 120 489 071, 0 120 489 221, 0 120 489 230, 0 120 489 231, 0 120 489 284, 0 120 489 684, 0 120 489 727, F010 LDO-102, 9 120 080 114, 9 120 080 126, 9 120 080 128, 9 120 080 137, 9 120 080 144, 9 120 080 147, 9 120 080 151, 9 120 080 174, 9 120 080 181, 9 120 080 187, 9 120 080 207, 9 120 080 219

RECTIFIER:

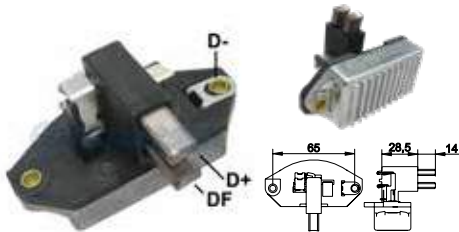
GA1366 / GA1541 / GA1509

BOSCH
GA018R

FEATURES / CARACTERÍSTICAS: 28V / 55A 'A' Circuit

REPLACES / REEMPLAZA:
Bosch: 9 190 087 018, 9 190 087 014, 0 192 053 006, 1986 AE0 007; **Regitar:** VRB198; **Cargo:** 130960; **WAI/Transpo:** IB374; **AS Poland:** ARE0027, **Huco/Hitachi:** 130525

APPLICATION / APLICACIÓN:
MERCEDES BENZ: Trucks, Bus, Stationary and Marit. with alt. 28V;

VOLVO: Trucks N10 (TD101 F/G), N12 (TD121 F/G), NL 12-400, NL 10-280, NL 10-340, N10 (TD100G), N12 (TD121GA) after 03.84, Bus B10M, B58E after 03.84;

CATERPILLAR: Motor Grader 3306, Wheel Loader 930 and 966, Tractor D4, D5, D6, D4E, D6D, D8L, 631E, 930 and 966;

SCANIA: Trucks T112, R112, T142, R142, T/R 112/310, T/R 112-360HW, T/R 142-410 HW, Mot. Marí.;

FORD: Trucks Cargo.

ALTERNATOR / ALTERNATOR:
BOSCH: 0 120 469 527, 0 120 469 691, 0 120 469 752, 0 120 469 753, 0 120 488 125, 0 120 488 232, 0 120 489 053, 0 120 489 060, 0 120 489 071, 0 120 489 221, 0 120 489 230, 0 120 489 231, 0 120 489 284, 0 120 489 684, 0 120 489 727, F010 LDO-102, 9 120 080 114, 9 120 080 126, 9 120 080 128, 9 120 080 137, 9 120 080 144, 9 120 080 147, 9 120 080 151, 9 120 080 174, 9 120 080 181, 9 120 080 187, 9 120 080 207, 9 120 080 219

RECTIFIER:

GA1366 / GA1541 / GA1509

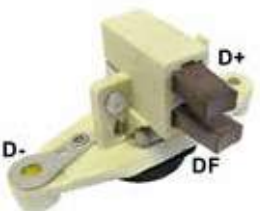
BOSCH
GA019 // NEW //

FEATURES / CARACTERÍSTICAS: 14V, 'A' Circuit

REPLACES / REEMPLAZA:
Bosch: 1 197 311 018, 1 197 311 039, 1 197 311 028; **Transpo:** IB356; **Cargo:** 133993; **AS-Poland:** ARE0004

APPLICATION / APLICACIÓN:
CITROËN: AX C1A/C3A 1.0L 1986>1998, AX CDYKat 1.0i 1992>1998, AX H1A/H1B/HAZ 1.1 1986>1998, AX K1A/K1B/K1F 1.4 1986>1992, BX 109LA 1.1 1988>1991, BX 150A/150C/150F/150J/150Y 1.4 1988>1991, BX K1F/K1G/KAZ 1.4 1988>1991, C15E - LCV C1A 1.0L 1988>1997, C15E - LCV HDZ Kat. 1.1i 1989, C15E - LCV K1G/K3A 1.4 1987>1996, C15E - LCV KDY Kat 1.4i 1992;

PEUGEOT: 205 TU1 1.1 1987>1990, 205 TU1M Kat 1.1i 1989>1998, 205 TU3FM 1.4i 1988>1998, 205 TU9M Kat 1.0i 1992>1998, 309 TU1 1.1 1989>1993, 309 TU3F2 1.4 1989>1993, 309 TU3S 1.4 1989>1993, 405 TU3 1.4 1987>1992, 405 TU3F2 1.4 1991>1992, 405 TU3TR 1.4 1987>1992

ALTERNATOR / ALTERNATOR:
BOSCH: 0 120 488 214, 0 120 488 215, 0 120 488 303, 0 120 489 467, 0 120 489 476;

CITROËN/ PEUGEOT: 91517980, 95632024, 9563521080

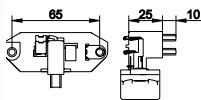
BOSCH
GA027

FEATURES / CARACTERÍSTICAS: 14V / 55A 'A' Circuit

REPLACES / REEMPLAZA:
Bosch: 9 190 087 027, 9 190 087 004, 9 190 087 010, 9 190 087 015, 9 190 087 029, 1986 AE0 008; **WAI/Transpo:** IB027; **Huco/Hitachi:** 130501; **Magneti Marelli:** RT510081

APPLICATION / APLICACIÓN:
VW: Apollo GL, GLS, Gol 1.6, GL, GT, GTS, GTI, Voyage / Parati 1.5, 1.6, GL, GLS, Santana CL, 1.8, 2.0, Quantum, Passat 1.5, 1.8, GTS, Pointer, all until 12.91; **FORD:** Del Rey 1.8, Belina 1.8, Pampa 1.8, Escort Guia 1.8, XR3, Guaruja, Verona 1.8 GLX, all until 12.91;

FIAT: Uno Mille, Uno 1.3, 1.5 Elba 1.3, 1.5 Fiat 147, Panorama, Fiorino

ALTERNATOR / ALTERNATOR:
BOSCH: 9 120 080 089, 9 120 080 095, 9 120 080 096, 9 120 080 098, 9 120 080 099, 9 120 080 108, 9 120 080 115, 9 120 080 116, 9 120 080 118, 9 120 080 120, 9 120 080 127, 9 120 080 139, 0 120 489 532, 0 120 489 535, 9 120 080 093

RECTIFIER:

GA1275 / GA1277



- Metallic body – BETTER HEAT DISSIPATION;
- Rotor short circuit protection;
- Better performance in relation of current and working temperature;

- Cuerpo de metal – MEJOR DISIPACIÓN DEL CALOR
- Protección de cortocircuito del rotor;
- Mejora del rendimiento relativo a corriente y temperatura de trabajo;

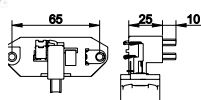
REPLACES / REEMPLAZA:

Same features as GA018, with 25mm brush holder.

APPLICATION / APLICACIÓN:

Voltage Regulator devices in a brush holder of 25mm.

ALTERNATOR / ALTERNATOR:

"A" Circuit 28V Alternator

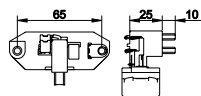
BOSCH
GA108R

FEATURES / CARACTERÍSTICAS: 28V / 55A 'A' Circuit

REPLACES / REEMPLAZA:

...

APPLICATION / APLICACIÓN:

Same features as GA018, with 25mm brush holder.

ALTERNATOR / ALTERNATOR:

...

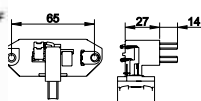
BOSCH
GA028

FEATURES / CARACTERÍSTICAS: 14V / 95A 'A' Circuit

REPLACES / REEMPLAZA:
Bosch: 9 190 087 028; **Huco/Hitachi:** 130508; **Magneti Marelli:** RT510082

APPLICATION / APLICACIÓN:
VW: Apollo GL, GLS, Gol 1.6, GL, GT, GTS, GTI, Voyage / Parati 1.5, 1.6, GL, GLS, Santana CL, 1.8, 2.0, EX, Quantum, Passat 1.5, 1.8, GTS, Pointer (all after 92 with AC); LADA: Niva Laika;

FORD: Del Rey 1.8, Belina 1.8, Pampa 1.8, Escort Guia 1.8, XR3, Guaruja, Escort Hobby, Verona 1.8 GLX (all after 92 with AC);

FIAT: Uno Mille, Uno 1.3, 1.5, Elba 1.3, 1.5, Fiat 147, Panorama, Fiorino.

ALTERNATOR / ALTERNATOR:
BOSCH: 9 120 080 161, 9 120 080 163, 9 120 080 164, 9 120 080 167, 9 120 080 175, 9 120 080 176, 9 120 080 177, 9 120 080 178, 9 120 080 179, 9 120 080 185, 9 120 080 186, 9 120 080 190, 9 120 080 191, 9 120 080 192, 9 120 080 193, 9 120 080 194, 9 120 080 195, 9 120 080 196, 9 120 080 197, 9 120 080 204, 9 120 080 206, 9 120 080 214, 9 120 080 220, F000 LDO-103

RECTIFIER:

GA1275 / GA1277 / GA1638 / GA1651

BOSCH
GA032
FEATURES / CARACTERÍSTICAS: 14V / 75A 'A' Circuit

REPLACES / REEMPLAZA:
Bosch: 9 190 087 032, 9 190 087 026, 1986 AE0 009; **WAI/Transpo:** IB357; **AS Poland:** ARE0047, **Huco/Hitachi:** 130512; **Magneti Marelli:** RT510084

APPLICATION / APLICACIÓN:
GM: Kadett 1.8, GS 2.0, GSI 2.0, Lite 1.8. Ipanema 1.8. Monza 2.0 MPFI;

FIAT: Uno 1.6R, 1.6R MPI. Premio. Elba 1.6 with AC, Tempra 8V, 16V with AC, Tempra Turbo without AC;

CITROËN: ZX 1.9, ZX 2.0, ZX 16V.

ALTERNATOR / ALTERNATOR:
BOSCH: 0 120 484 011, 0 120 484 205, 9 120 0806 153, 9 120 0806 165, 9 120 0806 168, 9 120 0806 169, 9 120 0806 170, 9 120 0806 171, 9 120 0806 172, 9 120 0806 173, 9 120 0806 180, 9 120 0806 198, 9 120 0806 203, 9 120 0806 208, 9 120 0806 211, 9 120 0806 213, 9 120 0806 221, 9 120 0806 224, 9 120 0806 229

RECTIFIER:

GA1275 / GA1652

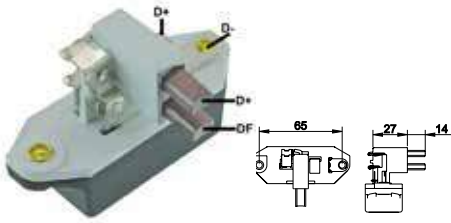
BOSCH
GA034
FEATURES / CARACTERÍSTICAS: 14V / 55A 'A' Circuit

REPLACES / REEMPLAZA:
Bosch: 9 190 087 034, 9 190 087 023, 9 190 087 016, 9 190 087 031, 1986 AE0 010; **Regitar:** VRB194; **Cargo:** 130958; **WAI/Transpo:** IB378, IB035; **AS Poland:** ARE0047, **Huco/Hitachi:** 130508; **Magneti Marelli:** RT510085

APPLICATION / APLICACIÓN:

- Metallic body – BETTER HEAT DISSIPATION;
- Rotor short circuit protection;
- Better performance in relation of current and working temperature;

- Cuerpo de metal – MEJOR DISIPACIÓN DEL CALOR
- Protección de cortocircuito del rotor;
- Mejora del rendimiento relativo a corriente y temperatura de trabajo;

TOYOTA: Bandeirante (after 88);

AGRALE: Trucks 1800K, Stationary M80/85/90, Tractors 4200 /4300 (M790) (after 06.85).

ALTERNATOR / ALTERNATOR:
BOSCH: 0 120 468 028, 0 120 468 055, 9 120 080 112, 9 120 080 113, 9 120 080 130, 9 120 080 136, 9 120 080 140, 9 120 080 141, 9 120 080 142, 9 120 080 143, 9 120 080 145, 9 120 080 148, 9 120 080 149, 9 120 080 154, 9 120 080 157, 9 120 080 158, 9 120 080 159, 9 120 080 160, 9 120 080 161, 9 120 080 162, 9 120 080 163, 9 120 080 164, 9 120 080 166, 9 120 080 167, 9 120 080 175, 9 120 080 176, 9 120 080 177, 9 120 080 178, 9 120 080 179, 9 120 080 182, 9 120 080 183, 9 120 080 184, 9 120 080 185, 9 120 080 186, 9 120 080 188, 9 120 080 190, 9 120 080 191, 9 120 080 192, 9 120 080 193, 9 120 080 194, 9 120 080 195, 9 120 080 196, 9 120 080 197, 9 120 080 199, 9 120 080 200, 9 120 080 201, 9 120 080 202, 9 120 080 204, 9 120 080 214, 9 120 080 218, 9 120 080 182

RECTIFIER:

GA1275 / GA1277 / GA1509 / GA1541 / GA1638 / GA1651

BOSCH
GA034R
FEATURES / CARACTERÍSTICAS: 14V / 55A 'A' Circuit

REPLACES / REEMPLAZA:
Bosch: 9 190 087 034, 9 190 087 023, 9 190 087 016, 9 190 087 031, 1986 AE0 010; **Regitar:** VRB194; **Cargo:** 130958; **WAI/Transpo:** IB378, IB035; **AS Poland:** ARE0047, **Huco/Hitachi:** 130508

APPLICATION / APLICACIÓN:
MERCEDES BENZ: Trucks, Bus, Stationary Ind. and Marit. with alternador 14V;

CBT: Tratores 8240, 2105, 8060;

MAXION: Harvester MF1630/ 3640/ 5650. Backhoe loader M750, MF86, Tractors 9110/ 9130. Stationary 4/ 6 Cil. Ind. MF235/ 265/ 272/ 275/ 283/ 290/ 292;

TOYOTA: Bandeirante (88>);

AGRALE: Trucks 1800K, Stationary M80/85/90, Tractors 4200 /4300 (M790) 06.85>

ALTERNATOR / ALTERNATOR:
BOSCH: 0 120 468 028, 0 120 468 055, 9 120 080 112, 9 120 080 113, 9 120 080 130, 9 120 080 136, 9 120 080 140, 9 120 080 141, 9 120 080 142, 9 120 080 143, 9 120 080 145, 9 120 080 148, 9 120 080 149, 9 120 080 154, 9 120 080 157, 9 120 080 158, 9 120 080 159, 9 120 080 160, 9 120 080 161, 9 120 080 162, 9 120 080 163, 9 120 080 164, 9 120 080 166, 9 120 080 167, 9 120 080 175, 9 120 080 176, 9 120 080 177, 9 120 080 178, 9 120 080 179, 9 120 080 182, 9 120 080 183, 9 120 080 184, 9 120 080 185, 9 120 080 186, 9 120 080 188, 9 120 080 190, 9 120 080 191, 9 120 080 192, 9 120 080 193, 9 120 080 194, 9 120 080 195, 9 120 080 196, 9 120 080 197, 9 120 080 199, 9 120 080 200, 9 120 080 201, 9 120 080 202, 9 120 080 204, 9 120 080 214, 9 120 080 218, 9 120 080 182

RECTIFIER:

GA1275 / GA1277 / GA1509 / GA1541 / GA1638 / GA1651

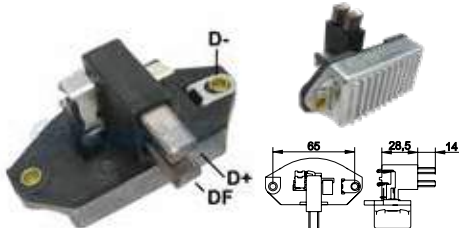

BOSCH

GA036



FEATURES / CARACTERÍSTICAS: 14V, 'A' Circuit

REPLACES / REEMPLAZA:

BMW: 12311435432; **Bosch:** 1197311545, 1197311547; **VW:** 037903803A; **Regitar:** VBR238; **Cargo:** 138999, 233568, 131224; **WAI/Transpo:** IB545, IB547, M507; **AS Poland:** ARE0010; **AS Poland:** ARE0046, **Huco/Hitachi:** 130564

APPLICATION / APLICACIÓN:

BMW: Serie 5 Saloon, Touring, Serie 3 Coupe, Saloon, Touring, Compact, Serie X5, Serie Z3 1995-2005

ALTERNATOR / ALTERNATOR:

BOSCH: 0123315013, 0123315022, 0123325010, 0123325011, 0123515002, 0123515004, 0123515007, 0123515010, 0123515022, 0123515023, 0123515025, 0123515030

BOSCH

GA037

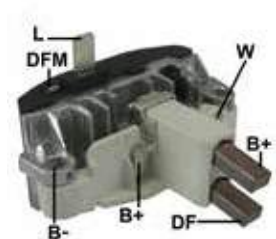

FEATURES / CARACTERÍSTICAS: 14V, 'A' Circuit

REPLACES / REEMPLAZA:

Bosch: 1197311520 / 1197311518; **Regitar:** VRB229; **Cargo:** 138109; **WAI/Transpo:** IB520

APPLICATION / APLICACIÓN:

Volvo: S40, V40

ALTERNATOR / ALTERNATOR:

Bosch: 123315021; **Volvo:** 9164940

BOSCH

GA310



FEATURES / CARACTERÍSTICAS: 28V, 'A' Circuit

REPLACES / REEMPLAZA:

Bosch: 1 197 311 310, 1 197 311 313; **Cargo:** 138292; **WAI/Transpo:** IB369-1; **Lester:** 12148

APPLICATION / APLICACIÓN:

Brush holder 24mm

ALTERNATOR / ALTERNATOR:

Bosch: 0-120-488-206/283/294, 0 0120 469 982, 0 0120 489 725;

Case: AR187916;

Cummins: 3284392, 3920678;

John Deere: AT161324

BOSCH

GA375

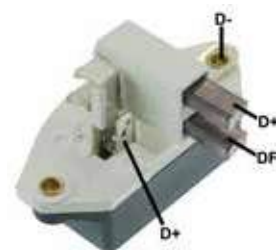

FEATURES / CARACTERÍSTICAS: 14V 'A' Circuit

REPLACES / REEMPLAZA:

Bosch: 9 190 067 001, 9 190 067 003, 9 190 067 005, 9 190 067 011; **Regitar:** VRB194; **WAI/Transpo:** IB375; **Magneti Marelli:** RT510143

APPLICATION / APLICACIÓN:

GM: Vehicles in Australia and South America with Alternator Bosch.

ALTERNATOR / ALTERNATOR:

BOSCH: 9 120 060 910

BOSCH

GA041

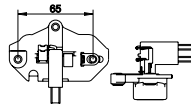

FEATURES / CARACTERÍSTICAS: 28V / 140A 'A' Circuit

REPLACES / REEMPLAZA:

Bosch: 9 190 457 001, 1 197 311 315, 9 190 457 051, 1 197 311 316, 0 192 053 003, 0 192 053 012, 0 192 053 025, 0 192 053 009, 0 192 053 014; **DELCO:** 19025516; **Regitar:** VRB206; **Cargo:** 131340; **WAI/Transpo:** IB381, IB381HD, IB382; **AS Poland:** ARE0032/0048, **Huco/Hitachi:** 130526 **Magneti Marelli:** RT510088

APPLICATION / APLICACIÓN:

VW: Chassis for Bus Volksbus, 16.210 CO, 17.240 OT - 17.260

EOT Electronic;

MAFERSA: Bus M-210, M-240;

FORD: Cargo 1618 6.10, B 1618 6.10 T

MERCEDES BENZ: Chassis and Bus O370 RS, O370 RSD, O371 R, O371 RS, O371 RSD, O371 U, O371 UP, OF 1620 OM 366 LA, OF 1721 OM 366 LA, OM 457 LA, OH 1621 LG M 366 LAG, OH 1623 LG M 366LAG, BR 400, Engine M366 G, O400 UP, BR450 BR900; Bus OM401, OM402, OM403, OM407, OM421, OM422, OM441, OM442, OM447, OM449, OM541; Trucks 1728, 2423, 2428 with motors OM906 LA 1114, 1114L, 1114 O, 1117 A, 1117L, 1120, 1120 AF, 1120 F, 1120L, 1120 O, 1124 AF, 1124 F, 1314, 1314 KO, 1320, 1320 OL, 1324, 1324L, 1514, 1514L, 1520, 1520L, 1524, 1524L, 1720, 2020, 817, 817F, 817L, 917, 917 AF, 917 AK with motors O402, O402F, OM357, OM356, OM366, 1938S, 1944S, 2638, LS1938, 1835LS, 1840LS, 1843LS, 2535LS, 2538, 2540LS, 2543LS, 2550, 2635, 3335, 3340, 3343, 4135, 4140, 4143, 1422 with motors OM427, OM402, OM445, OM446, OM421, OM441, OM442LA, OM447, OM457LA, OM489.

VOLVO: Bus B58, B10 M; **RANDOM:** Off road trucks; **EL DETALLE:** Bus OA 101 BF 6 L-913 C

SCANIA: Trucks and Bus K113 / L113 / N113

ALTERNATOR / ALTERNATOR:

BOSCH: 0 120 689 535, 0 120 689 562, 9 120 456 001, 9 120 456 010, 9 120 456 011, 9 120 456 012, 9 120 456 015, 9 120 456 031, 9 120 456 032, 9 120 456 034, 9 120 456 036, 9 120 456 038, 9 120 456 039, 9 120 456 040, 9 120 456 041, 9 120 456 042, 9 120 456 043, 9 120 456 046, 9 120 456 047, 9 120 456 048, 9 120 456 049, 9 120 456 050, 9 120 456 052, 9 120 456 053



- Metallic body – BETTER HEAT DISSIPATION;
- Rotor short circuit protection;
- Better performance in relation of current and working temperature;

- Cuerpo de metal – MEJOR DISIPACIÓN DEL CALOR
- Protección de cortocircuito del rotor;
- Mejora del rendimiento relativo a corriente y temperatura de trabajo;

BOSCH

GA041R

FEATURES / CARACTERÍSTICAS: 28V / 140A 'A' Circuit

REPLACES / REEMPLAZA:

Bosch: 9 190 457 001, 1 197 311 315, 9 190 457 051, 1 197 311 316, 0 192 053 003, 0 192 053 012, 0 192 053 025, 0 192 053 009, 0 192 053 014; **DELCO:** 19025516; **Regitar:** VRB206; **Cargo:** 131340; **WAI/Transpo:** IB381, IB381HD, IB382; **AS Poland:** ARE0032/ 0048; **Huco/Hitachi:** 130526; **Magneti Marelli:** RT510088

APPLICATION / APLICACIÓN:

VW: Chassis for Bus Volksbus, 16.210 CO, 17.240 OT - 17.260

EOT Electronic;

MAFERSA: Bus M-210, M-240;

FORD: Cargo 1618 6.10, B 1618 6.10 T

MERCEDES BENZ: Chassis and Bus O370 RS, O370 RSD, O371 R, O371 RS, O371 RSD, O371 U, O371 UP, OF 1620 OM 366 LA, OF 1721 OM 366 LA, OM 457 LA, OH 1621 LG M 366 LAG, OH 1623 LG M 366LAG, BR 400, Engine M366 G, O400 UP, BR450 BR900; Bus OM401, OM402, OM403, OM407, OM421, OM422, OM441, OM442, OM447, OM449, OM541; Trucks 1728, 2423, 2428 with motors OM906 LA 1114, 1114L, 1114 O, 1117 A, 1117 L, 1120, 1120 AF, 1120 F, 1120 L, 1120 O, 1124 AF, 1124 F, 1314, 1314 KO, 1320, 1320 OL, 1324, 1324L, 1514, 1514L, 1520, 1520L, 1524, 1524L, 1720, 2020, 817, 817F, 817L, 917, 917 AF, 917 AK with motors O402, O402F, OM357, OM356, OM366, 1938S, 1944S, 2638, LS1938, 1835LS, 1840LS, 1843LS, 2535LS, 2538, 2540LS, 2543LS, 2550, 2635, 3335, 3340, 3343, 4135, 4140, 4143, 1422 with motors OM427, OM402, OM445, OM446, OM421, OM441, OM442LA, OM447, OM457LA, OM489.

VOLVO: Bus B58, B10 M; **RANDOM:** Off road trucks; **EL DETALLE:** Bus OA 101 BF 6 L-913 C;

SCANIA: Trucks and Bus K113 / L113 / N113

ALTERNATOR / ALTERNATOR:

BOSCH: 0 120 689 535, 0 120 689 562, 9 120 456 001, 9 120 456 010, 9 120 456 011, 9 120 456 012, 9 120 456 015, 9 120 456 031, 9 120 456 032, 9 120 456 034, 9 120 456 036, 9 120 456 038, 9 120 456 039, 9 120 456 040, 9 120 456 041, 9 120 456 042, 9 120 456 043, 9 120 456 046, 9 120 456 047, 9 120 456 048, 9 120 456 049, 9 120 456 050, 9 120 456 052, 9 120 456 053, 9 120 080 015, 9 120 080 038; **DELCO:** 19025330, 19025331, 19025333, 19025339, 19025356

RECTIFIER:

GA1547 / GA1973

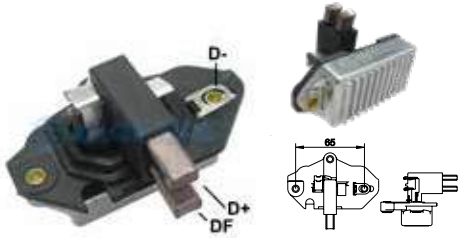

- Metallic body – BETTER HEAT DISSIPATION;
- Rotor short circuit protection;
- Better performance in relation of current and working temperature;

- Cuerpo de metal – MEJOR DISIPACIÓN DEL CALOR
- Protección de cortocircuito del rotor;
- Mejora del rendimiento relativo a corriente y temperatura de trabajo;

BOSCH

GA042

FEATURES / CARACTERÍSTICAS: 28V / 105A 'A' Circuit

REPLACES / REEMPLAZA:

Bosch: 9 190 457 003, 9 192 053 021, 1 197 311 320; **Regitar:** VRB219; **Cargo:** 137152; **WAI/Transpo:** IB386; **AS Poland:** ARE0035; **Huco/Hitachi:** 130545; **Magneti Marelli:** RT510089

APPLICATION / APLICACIÓN:

SCANIA: Bus, Chassis p/ Bus F112 HL, F113 HL, K113 CL, L113 CL, S113 AL, S113 CL, all with Alternator 9 120 456 003 (105A), Bus with Alternator 9 120 456 014 (105A);

MAFERSA: Trolebus with Alternator 9 120 456 028 (75A).

ALTERNATOR / ALTERNATOR:

BOSCH: 9 120 456 003, 9 120 456 014, 9 120 456 028

RECTIFIER:

GA1547

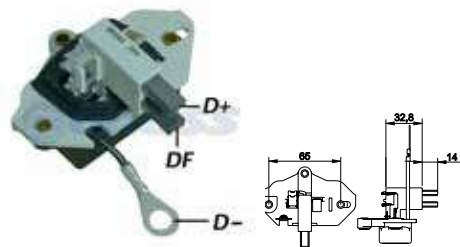

- Metallic body – BETTER HEAT DISSIPATION;
- Rotor short circuit protection;
- Better performance in relation of current and working temperature;

- Cuerpo de metal – MEJOR DISIPACIÓN DEL CALOR
- Protección de cortocircuito del rotor;
- Mejora del rendimiento relativo a corriente y temperatura de trabajo;

BOSCH

GA042R

FEATURES / CARACTERÍSTICAS: 28V / 105A 'A' Circuit

REPLACES / REEMPLAZA:

Bosch: 9 190 457 003, 9 192 053 021, 1 197 311 320; **Regitar:** VRB219; **Cargo:** 137152; **WAI/Transpo:** IB386; **AS Poland:** ARE0035; **Huco/Hitachi:** 130545; **Magneti Marelli:** RT510089

APPLICATION / APLICACIÓN:

SCANIA: Bus, Chassis for Bus F112 HL, F113 HL, K113 CL, L113 CL, S113 AL, S113 CL, all with alternator 9 120 456 003 (105A), Bus with alternator 9 120 456 014 (105A);

MAFERSA: Trolebus with alternator 9 120 456 028 (75A).

ALTERNATOR / ALTERNATOR:

BOSCH: 9 120 456 003, 9 120 456 014, 9 120 456 028

RECTIFIER:

GA1547

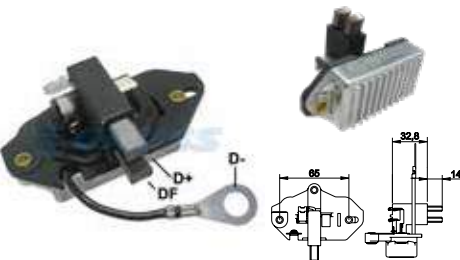

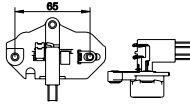
BOSCH
GA043

FEATURES / CARACTERÍSTICAS: 14V / 90A 'A' Circuit

REPLACES / REEMPLAZA:

Bosch: 9 190 457 043

APPLICATION / APLICACIÓN:

MAXION: Combine 3640, 5650 with engine PER 6.354.4 and alternator 9 120 456 027 (90A);

VW: Trucks 22.210, 23.210 with engine Cummins (eq. primary) and alternators 9 120 456 030 (90A);

MERCEDES BENZ: Several Urban Buses;

RENAULT: R19, R21.

ALTERNATOR / ALTERNATOR:

BOSCH: 9 120 456 008, 9 120 456 026, 9 120 456 027, 9 120 456 030, 9 120 456 037, 9 120 080 048, 9 120 080 052, 9 120 080 215

RECTIFIER:

GA1547

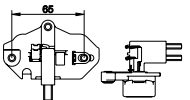
BOSCH
GA043R

FEATURES / CARACTERÍSTICAS: 14V / 90A 'A' Circuit

REPLACES / REEMPLAZA:

Bosch: 9 190 457 043

APPLICATION / APLICACIÓN:

MAXION: Harvester 3640, 5650 with engine PER 6.354.4 and alternator 9 120 456 027 (90A);

VW: Trucks 22.210, 23.210 with Cummins engine (eq. primary) and alternators 9 120 456 030 (90A);

MERCEDES BENZ: Several Urban Buses;

RENAULT: R19, R21.

ALTERNATOR / ALTERNATOR:

BOSCH: 9 120 456 008, 9 120 456 026, 9 120 456 027, 9 120 456 030, 9 120 456 037, 9 120 080 048, 9 120 080 052, 9 120 080 215Z

RECTIFIER:

GA1548

BOSCH
GA044 // NEW //

FEATURES / CARACTERÍSTICAS: 28V, S. POINT: 29V, 'A' Circuit

REPLACES / REEMPLAZA:

Bosch: 1 987 237 058, 1 197 311 309; **DAF:** 1606217; **Man:** 51 25601 6005; **Mobiletron:** VRB210; **Cargo:** 333268, 138756;

Transpo: IB364; **AS-Poland:** ARE0023

APPLICATION / APLICACIÓN:

DAF: 95 XF 1997>2002, 65 CF 1998>2000, CF 75 2001>2013, 75 CF 1998>2000, CF 85 2001>2013, 85 CF 1998>2000

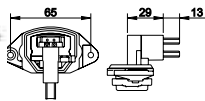
BOSCH
GA301

FEATURES / CARACTERÍSTICAS: 28V / 65A 'A' Circuit

REPLACES / REEMPLAZA:

Bosch: 1 197 311 301, 1 197 311 300, 1 197 311 305, 1 197 311 306, 1 197 311 310; **Regitar:** VRB203; **Cargo:** 132903; **WAI/**

Transpo: IB362; **AS Poland:** ARE0005/0026

APPLICATION / APLICACIÓN:

MERCEDES BENZ: Trucks 609, 611, 614, 709, 711, 714, 809, 811, 814, 914, 917, 1114, 1320, 1514;

Chassis and Bus OF1315, OF1318, OH1418 and 1635.

ALTERNATOR / ALTERNATOR:

BOSCH: 0 120 468 131, 0 120 468 053, 0 120 468 054, 0 120 468 107, 0 120 468 113, 0 120 468 136, 0 120 468 137, 0 120 469 001,

0 120 469 008, 0 120 469 019, 0 120 469 025, 0 120 469 032, 0 120 469 039, 0 120 469 115, 0 120 469 116, 0 120 469 518,

0 120 469 562, 0 120 469 652, 0 120 469 692, 0 120 469 761, 0 120 469 772, 0 120 469 797, 0 120 469 807, 0 120 469 856,

0 120 469 857

RECTIFIER:

GA1543 / GA1989 / GA1955 / GA1977

BOSCH
GA023

FEATURES / CARACTERÍSTICAS: 14V, 'A' Circuit

REPLACES / REEMPLAZA:

Bosch: 1 197 311 032, 1 197 311 033, 1 197 311 045; **Regitar:** VRB260; **Cargo:** 132666; **WAI/Transpo:** IB368; **AS Poland:**

ARE0025. **Huco/Hitachi:** 130519

APPLICATION / APLICACIÓN:

CASE: 110, 120, 135, 180, 181, 182 97>

ALTERNATOR / ALTERNATOR:

0 120 484 011, 0 120 484 018, 0 120 484 022, 0 120 484 024, 0 120 484 025, 0 120 484 026, 0 120 484 027, 0 120 484 050,

0 120 484 051, 0 120 488 134, 0 120 488 138, 0 120 488 205, 0 120 488 285, 0 120 488 293, 0 120 488 299

RECTIFIER:

GA1692

BOSCH
GA025

FEATURES / CARACTERÍSTICAS: 14V / 140A 'A' Circuit

REPLACES / REEMPLAZA:
Bosch: 1 197 311 034, IH 111 899 A1; **John Deere:** AL30420; **Regitar:** VRB202L; **Cargo:** 132666; **WAI/Transpo:** IB360; **AS Poland:** ARE0021/0025; **Huco/Hitachi:** 130513

APPLICATION / APLICACIÓN:
Tractors CASE: IH7120, IH7130, IH7140, IH8910, IH8920, IH8930, IH8940, IH8950;

Combine CASE: IH2155, IH2166, IH2188, IH2366, IH2555;

JOHN DEERE:
ALTERNATOR / ALTERNATOR:
BOSCH: 0 120 468 028, 0 120 468 055, 0 120 468 155, 6 033 G00 1BY, 6 033 G30 03B

RECTIFIER:

GA1708 / GA1920 / GA1954

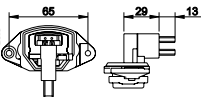
BOSCH
GA304

FEATURES / CARACTERÍSTICAS: 28V / 80A 'A' Circuit

REPLACES / REEMPLAZA:
Bosch: 1 197 311 304; **Scania:** 1117253; **Regitar:** VRB209; **Cargo:** 135856; **WAI/Transpo:** IB363; **AS Poland:** ARE0022

APPLICATION / APLICACIÓN:
IVECO: Trucks serie 180E, 190E, 240E, 260E, 400E (until 09.92);

SCANIA: Trucks MT-DS11.94, 95, 96, 97, DS14.52, DSC11.56, 57, 58, 14.57, 61, 62, 63 and others;

VOLVO: Trucks F12 and N12 (until 01.90) B12, NL10, 12, Chassi B12 (until 01.96).

ALTERNATOR / ALTERNATOR:
BOSCH: 0 120 468 094, 0 120 468 114, 0 120 468 131, 0 120 469 014, 0 120 469 026, 0 120 469 643, 0 120 469 999, 0 120 488 271, 0 120 488 303, 0 120 488 410

RECTIFIER:

GA1989 / GA1955 / GA1995

BOSCH
GA365

FEATURES / CARACTERÍSTICAS: 28V 'A' Circuit

REPLACES / REEMPLAZA:
Bosch: 0 192 035 020, 0 192 053 015, 0 192 053 020, 1 197 311 308, 1 197 311 312, 1 197 311 327, 2 197 311 308, 2 197 311 312; **Cargo:** 136545; **WAI/Transpo:** IB365; **AS Poland:** ARE0024

APPLICATION / APLICACIÓN:
RENAULT: Ares 300, 340, Agora Line, Kerax; M210 Midliner, M250 Midliner, Premium 210 – 400;

VOLVO e SCANIA: Trucks;

ALTERNATOR / ALTERNATOR:
BOSCH: 0 120 468 132, 0 120 469 024, 0 120 469 036, 0 120 469 037, 0 120 469 693, 0 120 469 952, 0 120 469 963, 0 120 469 983

RECTIFIER:

GA1968

BOSCH
GA306

FEATURES / CARACTERÍSTICAS: 14V / 90A 'A' Circuit

REPLACES / REEMPLAZA:
Bosch: 9 191 337 306, 9 191 337 307, 9 191 337 02, F 010 RS0 201; **Regitar:** VRB207; **Cargo:** 132737; **WAI/Transpo:** IB399; **AS Poland:** ARE0037; **Magneti Marelli:** RT510141

APPLICATION / APLICACIÓN:
RENAULT: Clío 1.6i (after 02.97), Clío Motor C3L, R19, R19RN 1.6i, R19, R19RN 1.6i with AC, Trafic 2.2 and Diesel.

ALTERNATOR / ALTERNATOR:
BOSCH: 9 120 080 215, 9 120 080 231, 9 120 080 225, F010 LD0-001

RECTIFIER:

GA1923

BOSCH
GA397

FEATURES / CARACTERÍSTICAS: 14V 'A' Circuit

REPLACES / REEMPLAZA:
Bosch: 0 192 052 023; **Regitar:** VRB192, VRB204; **Cargo:** 130676; **WAI/Transpo:** IB358, IB397; **AS Poland:** ARE0001/0029

APPLICATION / APLICACIÓN:
TALBOT: 1510 80-82, Horizon 79-86, Matra Rancho 1.4 78, Solara 80-86, Murena 1.6.

ALTERNATOR / ALTERNATOR:
BOSCH: 0 120 489 059, 0 120 489 999, 9 120 144 219, 9 120 144 220, 9 120 144 232, 9 120 144 233

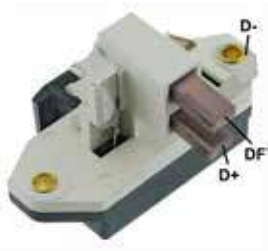
BOSCH
GA398

FEATURES / CARACTERÍSTICAS: 14V 'A' Circuit

REPLACES / REEMPLAZA:
Bosch: 0 192 052 030; **Cargo:** 131375; **Lucas:** UCB405; **Mobiletron:** VR-B205; **Regitar:** VRB205

APPLICATION / APLICACIÓN:
RENAULT: R5 1.3TS, R5 1.4;

PEUGEOT: 205, 305, 309, 405;

CITROËN: BX15, BX16, BX19

ALTERNATOR / ALTERNATOR:
BOSCH: 9 120 144 231; **LESTER:** 13137; **PIC:** 202102

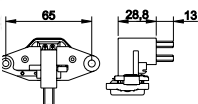
BOSCH
GA021

FEATURES / CARACTERÍSTICAS: 14V / 90A 'A' Circuit

REPLACES / REEMPLAZA:
Bosch: 1 197 311 021, 1 197 311 006, 1 197 311 012, 1 197 311 004, 1 197 311 010, 1 197 311 013, 1 197 311 005, 1 197 311 011;

Regitar: VRB195; **Cargo:** 130958; **WAI/Transpo:** IB352; **AS Poland:** ARE0002; **Huco/Hitachi:** 130503; **Magneti Marelli:** RT510078

APPLICATION / APLICACIÓN:
FORD: Versailles, Royale 1.8, 2.0 with AC;

VW: Santana, Quantum 1.8, 2.0 with AC., Engine 1.6 Diesel (exp. Argentina)

ALTERNATOR / ALTERNATOR:
BOSCH: 0 120 468 001, 0 120 468 002, 0 120 468 003, 0 120 468 006, 0 120 468 070, 0 120 468 546, 0 120 469 002, 0 120 469 003, 0 120 469 006, 0 120 469 011, 0 120 469 012, 0 120 469 015, 0 120 469 541, 0 120 469 542, 0 120 469 543, 0 120 469 545, 0 120 469 546, 0 120 469 727, 0 120 469 728, 9 120 080 217, 9 120 080 226

RECTIFIER:

GA1677 / GA1710

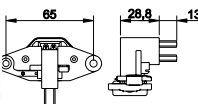
BOSCH
GA022

FEATURES / CARACTERÍSTICAS: 14V / 90A, 'A' Circuit, With Resistor

REPLACES / REEMPLAZA:
Bosch: 1197311022, 1197311003, 1197311023, 1197311007, 1197311050, 1197311009; **Regitar:** VRB196MH, VRB196ML; **Cargo:** 132980, 137127; **WAI/Transpo:** IB355, IB354; **AS Poland:** ARE0003, ARE0016; **Huco/Hitachi:** 130514; **Magneti Marelli:** RT510079

APPLICATION / APLICACIÓN:
MERCEDES BENZ: Furgão, Pick up MB 180.

ALTERNATOR / ALTERNATOR:
BOSCH: 0 120 489 917, 0 120 489 933, 9 120 080 217, 9 120 080 74

RECTIFIER:

GA1277

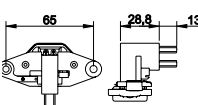
BOSCH
GA026

FEATURES / CARACTERÍSTICAS: 14V / 90A 'A' Circuit

REPLACES / REEMPLAZA:
Bosch: 1 197 311 026, 1 197 311 035, 1 197 311 038, 1 197 311 027, 1 197 311 040, 9 191 337 303; **GM:** 90349704, 90349907;

Regitar: VRB195ML, VRB196MH; **Cargo:** 135797, 132980; **WAI/Transpo:** IB353, IB355; **AS Poland:** ARE0014; **Huco/Hitachi:** 130522; **Magneti Marelli:** RT510080

APPLICATION / APLICACIÓN:
FIAT: Tempra (Argentino), Tempra Turbo 2.0i with AC. after 04.94, Tipo 1.6ie with AC. 03.93 to 10.95, Tipo 1.6ie with AC. 03.93 to 10.95, Tipo 2.0ie nacional 03.93 to 10.95, Uno Turbo 1.4 IE 09.89 to 09.92;

NEW HOLLAND: Tractor 8430, 8630 and 8830 DT (MBB OM 8365) after 12.93.

ALTERNATOR / ALTERNATOR:
BOSCH: 0 120 469 028, 0 120 469 034, 0 120 469 035, 0 120 469 940, 0 120 469 981, 0 120 488 250, 0 120 488 263, 9 120 080 227, 9 120 080 228

RECTIFIER:

GA1275 / GA1708 / GA1730

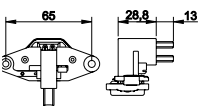
BOSCH
GA029

FEATURES / CARACTERÍSTICAS: 14V / 115A, 'A' Circuit

REPLACES / REEMPLAZA:
Bosch: 1 197 311 028; **Regitar:** VRB195ML; **Cargo:** 135797; **WAI/Transpo:** IB353; **AS Poland:** ARE0014; **Huco/Hitachi:** 130512; **Magneti Marelli:** RT510083

APPLICATION / APLICACIÓN:
GM: Corsa 1.0/ 1.4 EFI (after 04.94). Omega/ Suprema 2.0i, 2.2i, 3.0i (after 09.92). Omega, Suprema 2.0i, 2.2i, 3.0i with AC (after / after 03.3).

ALTERNATOR / ALTERNATOR:
BOSCH: 0 120 469 729, 0 120 469 923, 0 120 469 924, 0 120 488 158, 0 120 488 159, 0 120 488 192, 0 120 488 193

RECTIFIER:

GA1710 / GA1735 / GA1651

BOSCH
GA039
FEATURES / CARACTERÍSTICAS: 14V / 55A, 'A' Circuit

REPLACES / REEMPLAZA:
Bosch: 9 190 087 039; **AS Poland:** ARE0104; **Magneti Marelli:** RT510086

APPLICATION / APLICACIÓN:
GM: Corsa 1.0 MPFI, Corsa Super 1.0 MPFI.

ALTERNATOR / ALTERNATOR:
BOSCH: 9 120 080 500

RECTIFIER:

GA1089

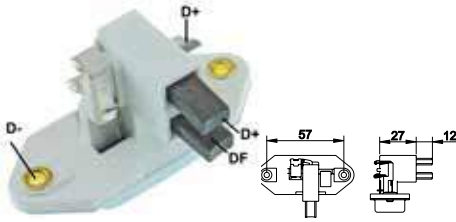
BOSCH
GA040
FEATURES / CARACTERÍSTICAS: 14V / 85A, 'A' Circuit

REPLACES / REEMPLAZA:
Bosch: 9 190 087 040, F 000 RS0 101; **Magneti Marelli:** RT510087

APPLICATION / APLICACIÓN:
VW: Gol Mi all (97>), Apolo, Logus, Parati, Pointer 1.6/ 1.8/ 2.0;

FORD: Escort, Royale, Verona, Versailles, F1000, Ranger;

GM: Corsa 1.0 MPFI, Corsa Super MPFI, Pick up S10, Silverado.

ALTERNATOR / ALTERNATOR:
BOSCH: 9 120 080 212, 9 120 080 217, 9 120 080 226, 9 120 080 230, 9 120 080 232, 9 120 080 501, 9 120 080 502, F000 LD0-100

RECTIFIER:

GA1089 / GA1012 / GA1129 / GA1336

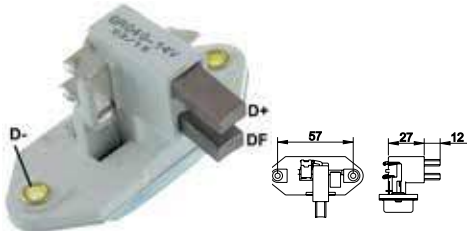

BOSCH
GA089 // NEW //
FEATURES / CARACTERÍSTICAS: 14V, 'A' Circuit

REPLACES / REEMPLAZA:
Bosch: 0 192 052 007, 0 192 052 010, 1 197 311 047, 9 191 337 311; **VW:** 043-903-803F, 043-903-803G; **Mobiletron:** VR-B220;

Transpo: IB371; **Cargo:** 130013

APPLICATION / APLICACIÓN:
VOLKSWAGEN: Beetle H4 1.6 1975>1979, Super Beetle H4 1.6 1975>1980

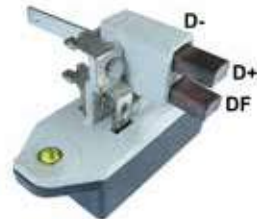
ALTERNATOR / ALTERNATOR:
BOSCH: 0 120 489 565, 0 120 489 566, 0 120 489 583, 0 120 489 584;

VALEO: 436184

BOSCH
GA090
FEATURES / CARACTERÍSTICAS: 14V CP

REPLACES / REEMPLAZA:
Bosch: 1197311090, 0192052003, 0192052018, 1197311000, 1197311001, 1197311002, 1197311090;

Regitar: VRB193ML, VRB193, **Cargo:** 130676, 133095, 133501, **WAI/Transpo:** IB348, IB350, IB351, IB370(A), **AS Poland:** ARE0020, ARE0001, ARE0019, **Huco/Hitachi:** 130507, 130501

APPLICATION / APLICACIÓN:
AUDI: 100 Series, 4000

ALTERNATOR / ALTERNATOR:
BOSCH: 0 120 300 552, 0 120 300 560, 0 120 339 503, 0 120 339 504, 0 120 339 505, 0 120 339 506, 0 120 339 509, 0 120 339 510, 0 120 339 511, 0 120 339 512, 0 120 339 513, 0 120 339 514, 0 120 339 515, 0 120 339 516, 0 120 339 517, 0 120 339 518, 0 120 339 519, 0 120 339 520, 0 120 339 521, 0 120 339 522, 0 120 339 523, 0 120 339 531, 0 120 339 532, 0 120 339 533, 0 120 339 534, 0 120 339 535, 0 120 339 536, 0 120 339 539, 0 120 339 542, 0 120 339 543, 0 120 339 544, 0 120 339 545, 0 120 339 546, 0 120 469 500, 0 120 469 501, 0 120 469 506, 0 120 469 510, 0 120 469 511, 0 120 469 512, 0 120 469 513, 0 120 469 514, 0 120 469 517, 0 120 469 522, 0 120 469 524, 0 120 469 525, 0 120 469 528, 0 120 469 530, 0 120 469 531, 0 120 469 533, 0 120 469 534, 0 120 469 535, 0 120 469 536, 0 120 469 537, 0 120 469 551, 0 120 469 552, 0 120 469 553, 0 120 469 554, 0 120 469 555, 0 120 469 556, 0 120 469 557, 0 120 469 558, 0 120 469 570, 0 120 469 573, 0 120 469 574, 0 120 469 577, 0 120 469 578, 0 120 469 688, 0 120 488 203, 0 120 489 001, 0 120 489 002, 0 120 489 003, 0 120 489 004, 0 120 489 005, 0 120 489 006, 0 120 489 007, 0 120 489 008, 0 120 489 009, 0 120 489 010, 0 120 489 011, 0 120 489 014, 0 120 489 015, 0 120 489 016, 0 120 489 017, 0 120 489 019, 0 120 489 021, 0 120 489 024, 0 120 489 028

BOSCH
GA208
FEATURES / CARACTERÍSTICAS: 14V 'A' Circuit

REPLACES / REEMPLAZA:
Bosch: 1 197 311 512, 1 197 311 240, 1 197 311 551, 1 197 311 552, 1 197 311 553; **Regitar:** VRB200H, VRB240H; **Cargo:** 138108;

WAI/Transpo: IB512; **AS Poland:** ARE0017, ARE0006, **Huco/Hitachi:** 130555; **Mobiletron:** VR-B200H

APPLICATION / APLICACIÓN:
CITROËN: Berlingo 96-02, Xsara 97-00, Xantia 97-01, ZX 91-97;

PEUGEOT: 106 91-96, 206 99-03, 306 93-03, 405 92-97, Partner 96-02, Ranch 97>; Fiat Scudo 95-00;

NISSAN: Nicra 92-02

ALTERNATOR / ALTERNATOR:
BOSCH: 0 120 335 006, 0 120 335 007, 0 120 335 011, 0 120 335 012, 0 123 110 007, 0 123 110 009, 0 123 310 010, 0 123 310 011, 0 123 310 012, 0 123 310 013, 0 123 320 068

BOSCH
GA211

FEATURES / CARACTERÍSTICAS: 14V / 100A, 'A' Circuit, With Resistor

REPLACES / REEMPLAZA:

Bosch: 1 197 311 211, 1 197 311 213, 1 197 311 217, 1 197 311 219; **Regitar:** VRB201H; **Cargo:** 134761; **WAI/Transpo:** IB387; **AS Poland:** ARE007; **Mobileron:** VR-B261

APPLICATION / APLICACIÓN:

MERCEDES BENZ;

VOLVO;

VW: Corrado, Passat.

ALTERNATOR / ALTERNATOR:

BOSCH: 0 120 485 011, 0 120 485 012, 0 120 485 022, 0 120 465 004, 0 120 465 015, 0 120 465 017, 0 123 315 005, 0 123 320 041, 0 123 335 002, 0 123 335 003, 0 123 510 101, 0 123 520 012, 0 123 540 004

RECTIFIER:

GA1510

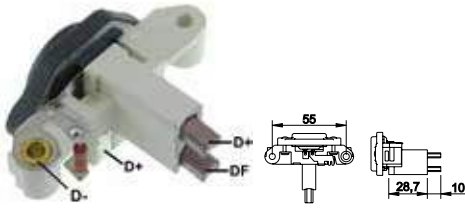
BOSCH
GA212

FEATURES / CARACTERÍSTICAS: 14V / 100A, 'A' Circuit

REPLACES / REEMPLAZA:

Bosch: 1 197 311 212, 1 197 311 225, 1 197 311 530, 1 197 311 175, 1 197 311 232, 1 197 311 220, 1 197 311 238, 1 197 311 224, 1 197 311 500; **Regitar:** VRB222, VRB200H; **Cargo:** 137183, 134687; **WAI/Transpo:** IB388, IB385, IB389; **AS Poland:** ARE0006, ARE0011; **Magneti Marelli:** RT510112

APPLICATION / APLICACIÓN:

GM: Corsa 1.0, 1.4;

ALFA ROMEO: Alfa ISS 2.0 T.S.;

AUDI: A4;

NISSAN: Primera;

VW: Bus, Golf, Passat, Vento.

ALTERNATOR / ALTERNATOR:

BOSCH: 0 120 485 015, 0 120 485 018, 0 120 485 019, 0 120 485 020, 0 120 485 023, 0 120 485 025, 0 120 485 026, 0 120 485 029, 0 120 485 034, 0 120 485 036, 0 123 100 002, 0 123 310 016, 0 123 310 026

RECTIFIER:

GA1561

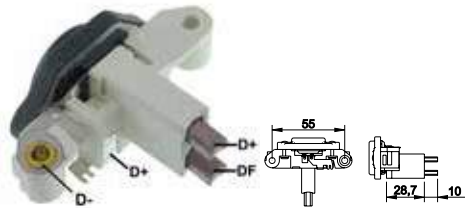
BOSCH
GA214

FEATURES / CARACTERÍSTICAS: 14V / 120A, 'A' Circuit

REPLACES / REEMPLAZA:

Bosch: 1 197 311 214; **Regitar:** VRB200H; **Cargo:** 134687; **WAI/Transpo:** IB385; **AS Poland:** ARE0006; **Magneti Marelli:** RT510118

APPLICATION / APLICACIÓN:

ALFA ROMEO: Alfa 164 2.0 V6 Turbo, 164 3.0 V6 12V (92>98);

GM: Astra 1.8i, 2.0i, 2.0i 16V without AC (10.98 a 09.99), Corsa 1.6 GSi 16V, Pick-up 1.6 EFI, Sedan 1.6 MPFI (after 03.95), Omega/Suprema 3.0i e 4.1i with AC (after 09.92), Vectra CD 2.0 16V, GLS 2.0, GSi 2.0 16V e GLS 2.0i without AC (10.93>09.99)

ALTERNATOR / ALTERNATOR:

BOSCH: 0 120 465 028, 0 123 120 00, 0 123 310 042, 0 123 505 002, 0 123 510 063, F010 LD0-202

RECTIFIER:

GA1560 / GA1740

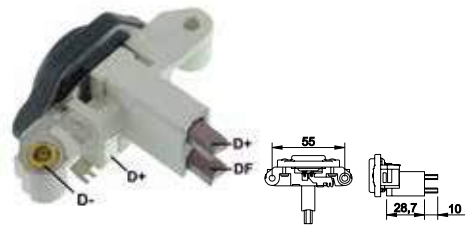
BOSCH
GA223

FEATURES / CARACTERÍSTICAS: 14V / 120A, 'A' Circuit

REPLACES / REEMPLAZA:

Bosch: 1 197 311 223, 1 197 311 500, 1 197 311 530, 1 197 311 548, 1 197 311 531; **Regitar:** VRB200H, VRB222; **Cargo:** 134687, 137183; **WAI/Transpo:** IB385, IB388; **AS Poland:** ARE0006, ARE0011; **Magneti Marelli:** RT510120

APPLICATION / APLICACIÓN:

VW: Gol/ Parati 1.0Mi e 1.0Mi 16V without AC, Gol, Parati/ Saveiro 1.6Mi, 1.8Mi, 2.0Mi/ 2.0Mi 16V with AC, Golf GL 2.0/ GLX, Golf III 1.8, Golf III 1.8 Passat/ Variant 1.8i/ 2.0i with AC, Polo Classic 1.6Mi, 1.8Mi (AP), Van 1.6Mi without AC, Santana/ Quantum 1.8Mi, 2.0Mi with AC, Saveiro 1.6Mi, 1.8Mi (AP) with AC;

AGRALE: Micro Bus Marcopolo Volare;

SEAT: Cordoba Ibiza 1.8;

IVECO: Daily 98>99 / 96>99

ALTERNATOR / ALTERNATOR:

BOSCH: 0 123 310 019, 0 123 310 020, 0 123 315 500, 0 123 320 001, 0 123 320 002, 0 123 320 007, 0 123 320 026, 0 123 320 030, 0 123 510 001, 0 123 515 016

RECTIFIER:

GA1852 / GA1667 / GA1560 / GA1734

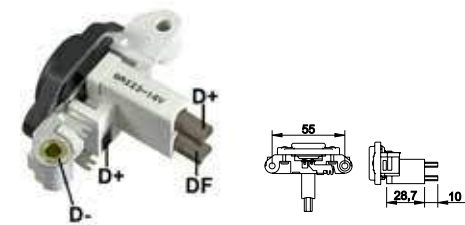

BOSCH

GA523

FEATURES / CARACTERÍSTICAS: 14V / 120A, 'A' Circuit, 2 Contacts

REPLACES / REEMPLAZA:

Bosch: 1 197 311 523; **Regitar:** VRB222; **Cargo:** 137183; **WAI/Transpo:** IB388; **AS Poland:** ARE0011; **Magneti Marelli:** RT510164

APPLICATION / APLICACIÓN:

FORD: Fiesta 1.0, 1.3, KA without AC. Escort SW GL/GLX 1.8i, Escort GL 1.8i 16V, Escort GLX 1.8i 16V (all with motor Zetec);

AUDI: Cabriolet;

SEAT: Cordoba 1.9 diesel, 1.9 SDI, 1.9 TDI.

ALTERNATOR / ALTERNATOR:

BOSCH: 0 123 310 023, 0 123 320 050

RECTIFIER:

GA1570

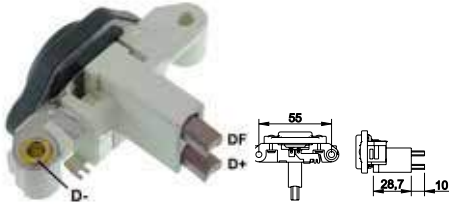

BOSCH

GA190

FEATURES / CARACTERÍSTICAS: 14V 'A' Circuit

REPLACES / REEMPLAZA:

Bosch: 9 190 041 002; **Transpo:** IB 501; **Unipoint:** YRV10; **Mobiletron:** VR-B250; **AS Poland:** ARE0033

APPLICATION / APLICACIÓN:

NISSAN: Tsuru (Mexico)

ALTERNATOR / ALTERNATOR:

BOSCH: 9 127 045 300



BOSCH

GA063

FEATURES / CARACTERÍSTICAS: 14V, 'A' Circuit, Terminals IG-L

REPLACES / REEMPLAZA:

Bosch: F 00M 255 200, F 00M 255 201, F 00M 255 202; **Regitar:** VRB394; **Cargo:** 235460; **WAI/Transpo:** IB200; **AS Poland:** ARE0055

APPLICATION / APLICACIÓN:

BMW: (2004-99) Land Rover (2008-03)

ALTERNATOR / ALTERNATOR:

Bosch IR/LC Water Cooled Alternators.



BOSCH

GA064 // NEW //

FEATURES / CARACTERÍSTICAS: 14V, 'A' Circuit

REPLACES / REEMPLAZA:

Bosch: 0 122 9AA 0X0; **Cargo:** 235528; **Transpo:** IB201; **Mobiletron:** VR-B257; **Regitar:** VRB257

APPLICATION / APLICACIÓN:

MERCEDES: C200 2200 2000>2003, C200/C220 CDI 2.2 2000>2003, C270 2700 2000>2007, E200/E220 .2.2 1999>2000, E270 CDI 2.7 1999>2001, E320 CDI 3.2 1999>2000, G400 CDI 4.0 2000>2015, S320 CDI 3.2 1999>2002, ML270 2700 2000>2005, ML270 CDI 2.7 2000>2005, S400 CDI 4.0 1999>2005

ALTERNATOR / ALTERNATOR:

BOSCH: 0 122 0AA 0B0, 0 122 0AA 0D0, 0 122 0A A0R0, 0 122 0AA 1A0, 0 122 0AA 2A0;

MERCEDES-BENZ: A0001500650, A0001502050



BOSCH

GA273 // NEW //

FEATURES / CARACTERÍSTICAS: 14V, 'A' Circuit

REPLACES / REEMPLAZA:

Cargo: 139872; **AS-Poland:** ARE0062; **Transpo:** IB510; **Mobiletron:** VR-B510; **Regitar:** VRB510

APPLICATION / APLICACIÓN:

TOYOTA: Avensis T22 1600/1800 1997>2000, Carina E 1600/1800, Corolla 1600 1992>1999

ALTERNATOR / ALTERNATOR:

BOSCH: 0 123 325 002, 0 123 325 012, 0 123 325 014, 9 123 325 002;

TOYOTA: 27060-02060, 27060-02061, 27060-02100



BOSCH
GA363

FEATURES / CARACTERÍSTICAS: 14V, 'B' Circuit

REPLACES / REEMPLAZA:

Bosch: F00M346010, F00M346015, F00M346026, F00M346063, F00M346087, F 00M 346 136, F 00M 346 137, F 00M 346 027, F 00M 346 054, F 00M 346 096; **Cargo:** 330331, 330949, 330805; **Transpo:** IB6026, IB6137; **Mobiletron:** VR-B026, VR-B137; **AS Poland:** ARE0061, ARE0167, ARE0120; **Regitar:** VRB137

APPLICATION / APLICACIÓN:

VW: Gol, Voyage, Saveiro G5 (without AC) - only with alternator Bosch F000BL0400, can not be used GA343, CC 2.0 TDI 2011, Crafter 2.5 TDI 2008>2011, Passat 2.0 TDI 2010>2014, Passat alltrack 2.0 TDI 2012>2014, Passat CC 2.0 TDI 2008>2011, Passat variant 2.0 TDI 2010>2014

SKODA: SUPERB 2.0 TDI 16V 2009>2015, SUPERB 1.6 TDI 2010>2015, SUPERB Estate 1.6/2.0 TDI 2010>2015, YETI 2.0 TDI 4x4 2009

ALTERNATOR / ALTERNATOR:

BOSCH: F 000 BL0 400, 0 121 715 103, 0 121 715 003, 0 121 715 042, 0 121 715 047, 0 121 715 103, 0 121 715 142, F 00M 346 027; **VOLKSWAGEN:** 070 903 024 F, 070-903-024B, 070-903-024F, 070-903-024F, 070-903-139B, 070-903-139BX, 03G903023, 03G903023F, 03G903023FX, 03G903023X; **SKODA:** 03G903023, 03G903023F

BOSCH
GA391

FEATURES / CARACTERÍSTICAS: 14V 'A' Circuit

REPLACES / REEMPLAZA:

Bosch: 9 190 067 016, 9 190 067 017, 9 190 067 019, 9 190 067 020; **Regitar:** VRB391; **Cargo:** 136554; **WAI/Transpo:** IB391; **AS Poland:** ARE0049

APPLICATION / APLICACIÓN:

FORD: Ford Mercury Capri, Thermoking Units, Holden Commodore

ALTERNATOR / ALTERNATOR:

BOSCH: 0 124 215 001, 0 124 215 002, 0 124 215 003, 0 124 215 004, 0 124 215 005, 0 124 225 016, 0 124 225 026, 0 124 225 027, 0 124 415 015, 0 124 325 009, 0 124 325 028, 0 124 415 011, 0 124 415 012

RECTIFIER:

GA1425

BOSCH
GA392

FEATURES / CARACTERÍSTICAS: 14V 'A' Circuit

REPLACES / REEMPLAZA:

Bosch: 9 190 067 018; **Cargo:** 36555; **Regitar:** VRB392; **WAI/Transpo:** IB392; **AS Poland:** ARE0050

APPLICATION / APLICACIÓN:

Thermo King Mice: Equipment

Thermo King Trailer: Unit

John Deere Crawlers: 650H 4.5L Diesel 1998-2007)

ALTERNATOR / ALTERNATOR:

BOSCH: 0 120 060 027, 9 120 060 023, 9 120 060 027; **PIC:** 220344, 220344A, 220344C

RECTIFIER:

GA1067 / GA1347

BOSCH
GA216 // NEW //

FEATURES / CARACTERÍSTICAS: 14V, S. POINT: 14,5V, 'A' Circuit

REPLACES / REEMPLAZA:

Bosch: F 00M 145 255, F 00M 145 361, F 00M 145 410; **Transpo:** IB255; **Cargo:** 233508

APPLICATION / APLICACIÓN:

Ford - Europe Car: Transit Box 2.4 2000>2006, Transit Bus 2.4 2000>2006

Ford - Europe Van: Tourneo Connect 2.4 2000>2015

Ford LCV - Europe Van: Transit VI 2.4 2000>2015

ALTERNATOR / ALTERNATOR:

...

BOSCH
GA220

FEATURES / CARACTERÍSTICAS: 14V 'A' Circuit

REPLACES / REEMPLAZA:

Bosch: F 00M 145 220, F 00M 145 349, F 00M A45 206; **Regitar:** VRB255, VRB256, VRB252; **Transpo:** IB206, IB220, IB231

APPLICATION / APLICACIÓN:

FIAT: Palio 1.0 99>01 / 05>06, 1.3 03>05, 1.4 05>07, 1.5 98>00 / 02>04, 1.8, Palio Weekend 1.4 05>, 1.5 02>04, Strada 1.4 05>, 1.5 99>04, 1.8 8V, Idea 1.4 05>, Siena 1.0 05>06, 1.4 05>, 1.5 02>04, Brava, Bravo, Multipla, Marea. Uno 1.0 98>03 / 05>, Furgoneta 1.5 00>04, Mille 98>03;

FORD: Fiesta 04/02>, 1.0 09/06, 1.6 04/06 >, Fiesta Sedan 1.0 09/06>, 1.6 09/04>;

ALFA ROMEO: 147, 156 02>05, Spider 1.8 98>00 e 2.0 00>06

ALTERNATOR / ALTERNATOR:

BOSCH: 0 124 215 001, 0 124 215 002, 0 124 215 003, 0 124 215 004, 0 124 215 005, 0 124 225 016, 0 124 225 026, 0 124 225 027, 0 124 415 015, 0 124 325 009, 0 124 325 028, 0 124 415 011, 0 124 415 012

RECTIFIER:

GA1425 / GA1426

BOSCH
GA222

FEATURES / CARACTERÍSTICAS: 14V 'B' Circuit

REPLACES / REEMPLAZA:
Bosch: F 00M 144 153, F 00M 144 154, F 00M 144 175, F 00M 145 261, F 00M 145 296, F 00M 145 315, F 00M 145 333, F 00M 145 341, F 00M 145 344, F 00M 145 383, F 00M 145 396, F 00M 145 397, F 00M 145 862, F 00M 145 876, F 00M 145 891, F 00M A45 300, F 00M A45 303, F 00M 144 152; **Audi/VW:** 6F-903-803, 06F-903-803B, 070-903-803B, 070-903-803E, 070-903-803EX, 078-903-803E, 078-903-803EX, 06F-903-803A; **Transpo:** IB261, IB5225, IB5225HD, IB861; **Mobiletron:** VR-B271, VR-B296; **Regitar:** VRB271, VRB296; **Cargo:** 139925, 235156; **AS-Poland:** ARE0144

APPLICATION / APLICACIÓN:
AUDI: A3 MK 2 HATCH 3-Door/5-Door 1.8 TFSI 2006>2013 / 1.8 TFSI quattro 2008>2013 / 2.0 TFSI 2004>2013 / 1.8 TFSI quattro 2004>2013, A4 MK 2 SALOON/AVANT/ESTATE 1.6 2000>2004 / 1.8T, 1.8T quattro 2000>2004 / 2.0 2000>2004 / 2.0 FSI 2002>2004, A4 CONVERTIBLE 1.8 T 2002>2009 / 1.8 T quattro 2003>2009 / 2.0 2004>2005 / 2.0 TFSI 16V 2006>2009 / A4 MK 3 SALOON/AVANT/ESTATE 1.6 2004>2008 / 1.8 T 2004>2008 / 1.8, 2.0 T quattro 2004>2008 / 2.0 TFSI 2004>2008 / 2.0 TFSI quattro 2004>2008, A6 MK 2 SALOON/AVANT/ESTATE 2.0 2001>2005, TT COUPE MK 2/ TT ROADSTER CABRIO MK 2 1.8 TFSI 2008>2014 / 2.0 TFSI 2006>2010 / 2.0 TFSI quattro 2008>2010;

SEAT: ALHAMBRA 1.8 TSI 12> / 2.0 TSI 2010->, ALTEA MPV 1.8 TFSI 2007->, ALTEA XL MPV 1.8 TFSI 0207-> / 2.0 TFSI 4x4 2009->, EXEO/EXEO ST 1.6 2009>2010 / 1.8 T 2008>2010 / 2.0 TFSI 2009->, LEON MK 2 HATCH 1.8 TSI 2007>2012 / 2.0 TFSI 2009>2012, TOLEDO MK 3 MPV 1.8 TFSI 2007>2009;

SKODA: OCTAVIA MK 2 HATCH 1.8 TSI 2007>2013 / 2.0 RS 2005>2013, OCTAVIA MK 2 ESTATE 1.8 TSI 2007>2013 / 1.8 TSI 4x4 2008>2013 / 2.0 RS 2005>2013, SUPERB MK 2/ESTATE 1.8 TSI 2008>2015 / 1.8 TSI 4x4 2008>2015 / 2.0 TSI 10>15, YETI 1.8 TSI 4x4 2009->;

VW: Beetle/ Convertible 2.0 TSI 2011->, EOS Convertible 2.0 TFSI 2006>2015 / 2.0 TSI 2009>2015, GOLF VI 1.8 TSI 2009>2011 / 2.0 GTI 2009>2012, GOLF VI Variant 2.0 TSI 2009>2013, GOLF VI Convertible 2.0 GTI 2011->, JETTA MK 3 SALOON 2.0 TFSI 2005>2010, JETTA IV 2.0 TSI 2010->, PASSAT MK 6 SALOON/ESTATE 1.8 TSI 2007>2011 / 2.0 FSI 2005>2010, PASSAT ALLTRACK 1.8 TSI 2012>2014, PASSAT CC SALOON 1.8 TSI 2008>2012 / 2.0 TSI 2008>2012, CC 1.8/2.0 TSI 2011->, PASSAT/PASSAT Variant 1.8 TSI 2010>2014, SCIROCCO MK 3 COUPE 2.0 TSI 2008->, SHARAN 2.0 TSI 2010->, TIGUAN TFSI 4Motion 2007->, TIGUAN TSI 4Motion 2011->;

MERCEDES: CLK320 3200 V6 1997>2003, CLK320 3200, V6 1997>2003, E240 2600 V6 2002>2009, E280 2800 1996>2003, E320 3200 1997>2002, Vaneo 3200 V6 2004, Vaneo 3500 V6 2004>2007

ALTERNATOR / ALTERNATOR:
BOSCH: 0124525088; **Audi/VW:** 06B 903 016 AB, 06B903016ABX, 06B903019E, 06B903019EX; **MERCEDES-BENZ:** 011-154-27-02, 011-154-92-02, 011-154-94-02, 012-154-00-02, 012-154-03-02, 012-154-09-02, 012-154-13-02, 012-154-83-02, 013-154-80-02, 013-154-82-02, 013-154-84-02, 013-154-85-02, 013-154-86-02, 014-154-01-02, A011-154-27-02, A011-154-94-02, A0111549202, A0121540002, A0121540302, A0121540902, A0121541302, A0131548002, A0131548202, A0131548502, A0131548602, A0141540102

RECTIFIER:

GA1447

BOSCH
GA224 // NEW //

FEATURES / CARACTERÍSTICAS: 14V, S, POINT: 14,5V, A Circuit

REPLACES / REEMPLAZA:
Bosch: F 00M 145 875, F 00M 145 658, F 00M 145 332, F 00M 145 391

APPLICATION / APLICACIÓN:
Toyota: Yaris 1.4 2005>2010

ALTERNATOR / ALTERNATOR:
BOSCH: 0124225055; **TOYOTA:** 27060-0N011

BOSCH
GA225

FEATURES / CARACTERÍSTICAS: 14V 'A' Circuit

REPLACES / REEMPLAZA:
Bosch: F 00M 145 225, F 00M 144 136, F 00M 145 350, F 00M 144 137, F 00M 145 244, F 00M 145 356, F 00M 144 143, F 00M 145 287, F 00M 145 372; **VW:** 038903803; **Regitar:** VRB254, VRB414, VRB244; **Cargo:** 139925; **WAI/Transpo:** IB5225; **AS Poland:** ARE0008, ARE0124, ARE0168; **Mobiletron:** VR-B414, VR-B254, VR-B244; **Magneti Marelli:** RT510121; **Transpo:** IB5356; **Cargo:** 235536, 236820; **AS-Poland:** ARE0168

APPLICATION / APLICACIÓN:
AUDI: A3, A1 1.4 TFSI 2011, A1 Sportback 1.4 TFSI 2011, A3 1.4 TFSI 2007>2012, A3 Convertible 1.4 TFSI 2011>2013, A3 Sportback 1.4 TFSI 2007>2013;

SEAT;
VW: Bora, Golf 4, New Beetle, Gol 1.0 Mi 16V/8V, Parati II 1.0 16V, Gol III 1.0 Mi e 1.0 Mi 16V e 1.0 16V Turbo, Parati III 1.0 Mi e 1.0 Mi 16V, Golf 4 1.9 TDI e SDI e 2.3, Sagitar 1.4 Turbo 2011>2013, Beetle Convertible 1.4 TSI 2011, Golf V 1.4 TSI 2005>2008, Golf VI Convertible 1.4 TSI 2011, Jetta IV 1.4 TSI 2011>2014, Passat 1.6 FSI 2005>2010, Passat Variant 1.6 FSI 2005>2010, Tiguan 1.4 TSI 2011

ALTERNATOR / ALTERNATOR:
BOSCH: 0 124 215 006, 0 124 215 012, 0 124 315 001, 0 124 315 002, 0 124 315 003, 0 124 315 004, 0 124 315 005, 0 124 315 006, 0 124 315 007, 0 124 315 008, 0 124 315 011, 0 124 315 012, 0 124 315 013, 0 124 315 018, 0 124 315 020, 0 124 315 021, 0 124 315 022, 0 124 325 001, 0 124 325 002, 0 124 325 003, 0 124 325 004, 0 124 325 011, 0 124 325 012, 0 124 325 013, 0 124 325 014, 0 124 325 015, 0 124 325 016, 0 124 325 021, 0 124 325 022, 0 124 325 032, 0 124 325 033, 0 124 325 034, 0 124 325 035, 0 124 325 041, 0 124 325 042, 0 124 325 043, 0 124 515 010, 0 124 515 012, 0 124 515 022, 0 124 515 026, 0 124 515 035, 0 124 515 038, 0 124 515 039, 0 124 515 042, 0 124 515 045, 0 124 515 046, 0 124 515 056, 0 124 515 057, 0 124 515 073, 0 124 525 074, 0 124 525 093, 0124325077, 0124515012, 0124615025, 0124615046, 0124625006; **AUDI/ VW:** 03C903023A, 03C903023AX

RECTIFIER:

GA1424 / GA1425

BOSCH
GA226

FEATURES / CARACTERÍSTICAS: 14V 'B' Circuit

REPLACES / REEMPLAZA:

Bosch: F 00M 144 109, F 00M 144 160; **Transpo:** IB160; **Regitar:** VRB160; **Cargo:** 332132, 333273

APPLICATION / APLICACIÓN:

OPEL: Astra H Hatch 1.6 2006>2014, Astra H GTC hatch 1.6 2006>2010, Astra H Saloon 1.6 2007>2014, Astra H Estate 1.6 2006>2014, Zafira B MPV 1.6 2005>;

CHEVROLET: Impala - Monte Carlo 3.5L 3.9L GMC

ALTERNATOR / ALTERNATOR:

BOSCH: 0 124 325 163, 0 124 325 171, 0 124 325 172, 0 124 325 221, 0 124 425 050, 0 124 425 057, 0 124 425 058, 0 124 425 059, 0 124 425 060, 0 124 425 084, 0 124 425 085, 0 124 425 086, 0 124 425 087, 0 124 425 096, 0 124 425 097

BOSCH
GA227

FEATURES / CARACTERÍSTICAS: 14V 'A' Circuit

REPLACES / REEMPLAZA:

Bosch: F 00M 145 207, F 00M 145 347, F 00M A45 228; **Cargo:** 231130; **AS Poland:** ARE0059; **Hitachi / Hüco:** 130614; **Mobiletron:** VR-B267; **Regitar:** VRB267; **Transpo:** IB347

APPLICATION / APLICACIÓN:

Mitsubishi: Space Star 1300/ 1600 1998>2006

ALTERNATOR / ALTERNATOR:

BOSCH: 0 124 325 008, 0 124 325 010, 0 124 515 041

BOSCH
GA228

FEATURES / CARACTERÍSTICAS: 14V 'A' Circuit

REPLACES / REEMPLAZA:

Bosch: F00M145265, F00M144171, F00M145228, F00M145283, F00M145371; **Opel:** 9193765, 93176049; **Transpo:** IB283;

Regitar: VRB371; **Mobiletron:** VR-B371

APPLICATION / APLICACIÓN:

OPEL: Astra G hatch/ saloon/ estate/ coupe/ convertible/ van 2.0/ 2.2 1998>2005, Signum 2.0/2.2 2003>, Speedster 2.0/2.2 2000>, Vectra B hatch/saloon/estate 2.2i 16v 2000>2003, Vectra C hatch/saloon/estate 2.0/2.2 2002>, Zafira A MPV 2.0/2.2 1999>2005

ALTERNATOR / ALTERNATOR:

BOSCH: 0124415009, 0124415025, 0124415026, 0124425004, 0124425019, 0124425048, 0124515032, 0124515033, 0124515095, 0124515096

BOSCH
GA229

FEATURES / CARACTERÍSTICAS: 14V 'A' Circuit

REPLACES / REEMPLAZA:

Bosch: F00M145229, F00M145351; **Regitar:** VRB221, **Cargo:** 237267, 335029; **WAI/Transpo:** IB229, IB229HD, **AS Poland:** ARE0041; **Mobiletron:** VR-B221, VR-B369

APPLICATION / APLICACIÓN:

VOLVO: S80 1999-2000 2.8L 120A, S80 1999-2001 2.9L 120A, S60 2001 2.3L, 2.4L 120A, Cross Country 2001 2.4L 120A

ALTERNATOR / ALTERNATOR:

BOSCH: 0 124 515 017, 0 124 515 054, 0 124 525 001, 0 124 525 014

BOSCH
GA230

FEATURES / CARACTERÍSTICAS: 14V 'B' Circuit

REPLACES / REEMPLAZA:

Bosch: F00M145232, F00M145243, F00M145252, F00M145270, F00M145427, F00M145674, F00M144189; **Fiat:** 9949367, 60672342, 60673305, 71716671; **Peugeot/Citroën:** 5761A8, 5705 4F, 5705AA, 96217914, 96408787; **Alfa Romeo:** 60672342; **Suzuki:** 3140068D02; **Regitar:** VRB263; **Cargo:** 232193; **WAI/Transpo:** IB252; **AS Poland:** ARE0052

APPLICATION / APLICACIÓN:

ALFA ROMEO: 147, 156, 166, Spider, GT; **FIAT:** Scudo, Ulysse (Diesel and Gasolina); **CITROËN:** Berlingo, Xsara, C5, C8 (Diesel - Europa); **LANCIA:** Zeta (Diesel); **PEUGEOT:** 206, 307, 406, Boxer, 607, 806 (Diesel - Europa)

ALTERNATOR / ALTERNATOR:

BOSCH: 0124515087, 0124515090, 0124615002, 0124615027; **FIAT:** 60672342; **LUCAS:** LRA02035; **ALFA ROMEO:** 60672342

BOSCH
GA231

FEATURES / CARACTERÍSTICAS: 14V 'A' Circuit

REPLACES / REEMPLAZA:

Bosch: F 00M 145 201, F 00M 145 231, F 00M 145 282, F 00M 145 370; **Regitar:** VRB252; **Cargo:** 139044; **WAI/Transpo:** IB231; ARE0012

APPLICATION / APLICACIÓN:

GM: Celta, Astra 1.8i /2.0i, Corsa 1.0 /1.4 /1.6 /1.6i /Gsi 1.6 /16V, Corsa 1.6 10/99>04/00;

VOLKSWAGEN: 13.180 Mot 6.10 TCA;

FORD: Cargo C 815 E Eletronic Interact 4 150; Cargo C 1317 E Eletronic Interact 4 170; Cargo C 1517 E Eletronic Interact 4 170; Cargo C 1717 E Eletronic Interact 4 170; Cargo C 1722 E Eletronic Interact 6; Cargo C 2422 E Eletronic Interact 6; Cargo C 2428 E Eletronic Interact 6; Cargo C 2622 E Eletronic Interact 6; Cargo C 2628 E Eletronic Interact 6; 1722 - 422, Cummins Interact 6, 5,9 ltrs; F 250 3.9 mot. Cummins Max Power

ALTERNATOR / ALTERNATOR:

BOSCH: 0 124 225 001, 0 124 225 028, 0 124 325 109, 0 124 325 115, 0 124 325 118, 0 124 325 136, 0 124 325 211

RECTIFIER:

GA1423

BOSCH

GA232



FEATURES / CARACTERÍSTICAS: 14V 'A' Circuit

REPLACES / REEMPLAZA:

Bosch: F00M145245, F00M145251, F00M145360, F00MA45236; **BMW:** 7501752, 12317501595, 12317501597, 12317501599, 12317501690, 12317501755; **Regitar:** VRB360. **Cargo:** 235549, 234263, 335025; **WAI/Transpo:** IB251, **AS Poland:** ARE0051; **Mobiletron:** VR-B360

APPLICATION / APLICACIÓN:

BMW: BMW (2001 -2006)

ALTERNATOR / ALTERNATOR:

BOSCH: 0124515050

BOSCH

GA233



FEATURES / CARACTERÍSTICAS: 14V 'B' Circuit

REPLACES / REEMPLAZA:

Bosch: F 00M 145 286, F 00M 145 394, F 00M 145 322; **Regitar:** VRB270; **Cargo:** 234770; **WAI/Transpo:** IB286; **AS Poland:** ARE0057

APPLICATION / APLICACIÓN:

MITSUBISHI: Pajero /Montero 3.2

ALTERNATOR / ALTERNATOR:

MITSUBISHI: A003T08699, A003T09699, A003TB1299, A3T08699, A3T09699, A3TB1299, ME200696, ME200698, ME202971

BOSCH

GA234



FEATURES / CARACTERÍSTICAS: 14V 'A' Circuit

REPLACES / REEMPLAZA:

Bosch: F 00M 145 214, F 00M 145 348, F 00M 144 183; **Regitar:** VRB253; **Cargo:** 139334; **WAI/Transpo:** IB214;

Magneti Marelli: RT510123

APPLICATION / APLICACIÓN:

CUMMINS: F250, F350, F4000;

MWM;

ALTERNATOR / ALTERNATOR:

BOSCH: 0 124 315 019, 0 124 415 006

BOSCH

GA235



FEATURES / CARACTERÍSTICAS: 14V 'A' Circuit

REPLACES / REEMPLAZA:

Bosch: F 00M 144 183, F 00M 145 214, F 00M 145 215, F 00M 145 235, F 00M 145 348, F 00M 145 672; **Cargo:** 235537; **WAI/Transpo:** IB235; **AS Poland:** ARE0040; **Magneti Marelli:** RT510124

APPLICATION / APLICACIÓN:

FORD: Fiesta, Ka, Courier

ALTERNATOR / ALTERNATOR:

BOSCH: 0 124 225 021

RECTIFIER:

GA1412 / GA1430

BOSCH

GA237



FEATURES / CARACTERÍSTICAS: 14V 'A' Circuit

REPLACES / REEMPLAZA:

Bosch: F 00M A45 235

APPLICATION / APLICACIÓN:

MERCEDES BENZ: Pad Mount - Bus 14V 80/150A

ALTERNATOR / ALTERNATOR:

BOSCH: 0 124 525 145

BOSCH

GA238



FEATURES / CARACTERÍSTICAS: 14V 'A' Circuit

REPLACES / REEMPLAZA:

Bosch: F 00M 144 190

APPLICATION / APLICACIÓN:

MERCEDES BENZ: Auto Bus 14V 125A

ALTERNATOR / ALTERNATOR:

BOSCH: 6 004 ML0 012

BOSCH
GA239

FEATURES / CARACTERÍSTICAS: 14V 'A' Circuit

REPLACES / REEMPLAZA:

Bosch: F 00M 145 239, F 00M 145 404, F 00M 144 111, F 00M 144 181, F 00M A45 237; **Regitar:** VRB242, VRB251; **Cargo:** 230624; **WAI/Transpo:** IB239; **AS Poland:** ARE0018; **Mobiletron:** VR-B242

APPLICATION / APLICACIÓN:

RENAULT: Clio II 99-07, Kangoo 98>, Megane, Grandtour 99>, Scenic 98>, Symbol 03>, Thalia II 99-07, Logan 04>, Laguna 97-03, Master 2.5 Dci

ALTERNATOR / ALTERNATOR:

BOSCH: 0 124 325 024, 0 124 325 184, 0 124 325 185, 0 124 325 031, 0 124 415 007, 0 124 415 013, 0 124 415 014, 0 124 415 041, 0 124 415 043, 0 124 525 133

RECTIFIER:

GA1425

BOSCH
GA240

FEATURES / CARACTERÍSTICAS: 14V 'A' Circuit

REPLACES / REEMPLAZA:

Bosch: F 00M 145 240, F 00M 145 206, F 00M 145 346; **Regitar:** VRB255; **Cargo:** 139933; **WAI/Transpo:** IB206; **AS Poland:** ARE0013

APPLICATION / APLICACIÓN:

HONDA: Civic 01 a 06, Fit >03, Accord 01-06

ALTERNATOR / ALTERNATOR:

BOSCH: 0 124 225 039, 0 124 225 042, 0 124 225 007, 0 124 325 006

RECTIFIER:

GA1425

BOSCH
GA261

FEATURES / CARACTERÍSTICAS: 14V 'A' Circuit

REPLACES / REEMPLAZA:

Bosch: F 00M 145 206, F 00M 145 240, F 00M 145 346, F 00M A45 238; **Transpo:** IB206; **Mobiletron:** VR-B254; **Regitar:** VRB254; **Cargo:** 333280

APPLICATION / APLICACIÓN:

VW: Trucks 13 150, 9 150; **MERCEDES BENZ:** 1214, 710

ALTERNATOR / ALTERNATOR:

BOSCH: 0 124 225 039, 0 124 225 042, 0 124 325 006, 0 124 325 007

RECTIFIER:

GA1424 / GA1425 / GA1428

BOSCH
GA264 // NEW //

FEATURES / CARACTERÍSTICAS: 14V 'A' Circuit

REPLACES / REEMPLAZA:

Bosch: F 00M 144 155, F 00M 145 266, F 00M 145 365, F 00M 145 883; **Mobiletron:** VR-B883; **Regitar:** VRB883; **AS-Poland:** ARE0066; **Cargo:** 234771; **Transpo:** IB266; **Era:** 215955

APPLICATION / APLICACIÓN:

MERCEDES BENZ: E220D 2200 2002>2010, E270D 2700 2002>2005, E320D 3200 Cdi 2002>2010

ALTERNATOR / ALTERNATOR:

BOSCH: 0 124 625 019;

MERCEDES-BENZ: 0121545902, 0121549802, A0121545902, A0121549802;

NEW HOLLAND: 125432565845

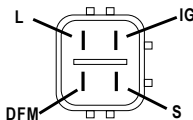
BOSCH
GA265

FEATURES / CARACTERÍSTICAS: 14V 'A' Circuit

REPLACES / REEMPLAZA:

Bosch: F 00M 145 873, F 00M 145 236, F 00M 145 305, F 00M 145 324, F 00M 145 865; **Regitar:** VRB243; **Cargo:** 233587; **WAI/Transpo:** IB236

APPLICATION / APLICACIÓN:

TOYOTA: Corolla, Fielder 99-08, Hilux, SW4 05-, L200, Camry 02-06, Avenys

ALTERNATOR / ALTERNATOR:

BOSCH: 0 120 000 023, 0 120 000 024, 0 120 000 025, 0 120 000 033, 0 120 000 034, 0 125 325 071, 0 125 325 086, 0 125 325 123, 0 125 325 165, 0 125 325 167, 0 124 315 029, 0 124 315 040, 0 124 OAC 5HB, 0 124 OAC 30B

RECTIFIER:

GA1425 / GA1438

BOSCH
GA266

FEATURES / CARACTERÍSTICAS: 14V 'B' Circuit

REPLACES / REEMPLAZA:
Bosch: F 00M 145 880, F 00M 145 312; **Transpo:** IB262; **Mobiletron:** VR-B880; **Regitar:** VRB880; **Cargo:** 236455;

AS-Poland: ARE0078

APPLICATION / APLICACIÓN:
BMW: 318i 2.0 Non-Turbo 2004>2012, 320i 2.0 Non-Turbo 2005>2012, 520Li 2.0 Non-Turbo 2010, 520Li 2.5 Non-Turbo 2011

ALTERNATOR / ALTERNATOR:
BOSCH: 0 124 525 059, 0 124 525 045, 0 124 525 561, 0 124 525 524; **BMW:** 12317532965, 12317532966, 12317532969, 12317533270

RECTIFIER:

GA1437

BOSCH
GA278 // NEW //

FEATURES / CARACTERÍSTICAS: 14V, 'A' Circuit

REPLACES / REEMPLAZA:
Bosch: F 00M 145 210, F 00M 145 230, F 00M 145 352, F 00M A45 207; **Volvo:** 9459746-5; **Transpo:** IB230; **Cargo:** 230994; **AS-Poland:** ARE0154; **Mobiletron:** VR-B221; **Era:** 215235

APPLICATION / APLICACIÓN:
VOLVO: C70 L5 2.3L / 2.4L 2000>2004, S60 L5 2.4L 2001, S70 L5 2.3L / 2.4L 1999>2000, V70 L5 2.3L / 2.4L 1999>2004, S40 I 1600/1800/1900/2000 1999>2004, S80 2000/2400 Turbo 2000>2004, S80 2500 Turbo 2003>2004, V40 1600/1800/1900/2000 1999>2004, XC70 cross country T3 2.4 T XC AWD 2000>2002

ALTERNATOR / ALTERNATOR:
BOSCH: 0 124 325 117, 0 124 515 018, 0 124 515 019;

VOLVO: 8601841-0, 8601841-3, 9459038, 9459077, 9459077-0, 9459077-5

BOSCH
GA281

FEATURES / CARACTERÍSTICAS: 14V 'A' Circuit

REPLACES / REEMPLAZA:
Bosch: F 00M 145 257, F 00M 145 362; **Cargo:** 234779; **WAI/Transpo:** IB257; **AS Poland:** ARE0088; **Mobiletron:** VR-B252; **Magneti Marelli:** RT510137

APPLICATION / APLICACIÓN:
GM: Corsa 1.0 00>05, Corsa Sedan 1.0 00>05 and 01/06, Celta 1.0 05>06, Astra 2.0 04>, Astra Sedan 1.8 05/01, 2.0 04/04, Omega 3.0/4.1, Vectra 2.0 05, 2.4 05, S 10, Zafira 2.0 04>;

FIAT: Fiat Stilo, Strada 1.8 04>, Palio 1.8R 04>

ALTERNATOR / ALTERNATOR:
BOSCH: 0 124 215 002, 0 124 215 004, 0 124 215 005, 0 124 225 016, 0 124 225 026, 0 124 225 027, 0 124 325 009, 0 124 325 028, 0 124 325 046, 0 124 415 011, 0 124 415 012, 0 124 415 015, 0 124 515 091, 0 124 615 015

RECTIFIER:

GA1425 / GA1426 / GA1427 / GA1436 / GA1446

BOSCH
GA282

FEATURES / CARACTERÍSTICAS: 14V 'A' Circuit

REPLACES / REEMPLAZA:
Bosch: F 00M 144 231, F 00M 145 282, F 00M 145 370, F 00M 144 142, F 00M 145 418, F 00M 144 139, F 00M 145 248, F 00M 145 358; **Regitar:** VRB252, VRB264; **Cargo:** 139044; **WAI/Transpo:** IB231; **Mobiletron:** VR-B264; **Magneti Marelli:** RT510138

APPLICATION / APLICACIÓN:
CHEVROLET: Astra 1.8i, 2.0i, Corsa 1.0, 1.4, 1.6, 1.6i, Gsi 1.6 16V, Corsa 1.6 10/99>04/00, Corsa Pickup 1.6, Sedan 1.6 MPFI, Vectra 11/97>10/99, 2.0 CD 16V, 2.2i 16V, Zafira 1.6, 1.8, 2.0 DTL 16V;

FIAT: Palio 1.0 03/99>05/01 1.5 98>00, Palio Weekend 1.6 98>, Ducato 00>05;

FIAT ALLIS: FB100.0 01/03>, FB 80.2 01/03>, Genesis 5.0;

IVECO: Daily 10 12/00>;

MERCEDES BENZ: Classe A 97>, Accelo 715C 2003>2005, Sprinter 311CDI 2001>2004, Sprinter 313CDI 2001>2012, Sprinter 413CDI 2001>2012; **BMW:** 740 94>99, 840 94>99; **TROLLER:** Troller 2010>

ALTERNATOR / ALTERNATOR:
BOSCH: 0 124 215 001, 0 124 215 003, 0 124 225 001, 0 124 225 002, 0 124 225 004, 0 124 225 009, 0 124 225 018, 0 124 225 022, 0 124 225 023, 0 124 225 024, 0 124 225 025, 0 124 325 023, 0 124 415 001, 0 124 415 002, 0 124 415 005, 0 124 415 008, 0 124 415 010, 0 124 515 004, 0 124 515 005, 0 124 515 006, 0 124 515 023, 0 124 515 031, 0 124 515 061, 0 124 515 079, 0 124 325 173, 0 124 325 039, 0 124 325 093, 0 124 515 064, 0 124 515 114, 0 124 615 019

RECTIFIER:

GA1421 / GA1424 / GA1425

BOSCH
GA283

FEATURES / CARACTERÍSTICAS: 28V, 'B' Circuit

REPLACES / REEMPLAZA:
Bosch: F 00M 144 125, F 00M 145 343

APPLICATION / APLICACIÓN:
FORD: Cargo C 1319 2012>, Cargo C 1519 2012>, Cargo C 1317 >2011, Cargo C 1517 >2011, Cargo C 1719 2012>, Cargo C 1723 2012>, Cargo C 1832 E 2010>2011, Cargo C 1932 R 2011>, Cargo C 1932 Tractor 2011>, Cargo C 1933 2012>, Cargo C 2422 >2011, Cargo C 2423 2012>, Cargo C 2428 >2011, Cargo C 2429 2012, Cargo C 2623 2012, Cargo C 1717 >2011, Cargo C 1722 >2011

ALTERNATOR / ALTERNATOR:
BOSCH: 0 124 555 029, F 000 BL0 771

FORD: 6C4510300AA

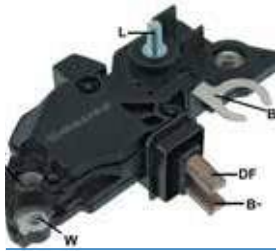
BOSCH
GA284

FEATURES / CARACTERÍSTICAS: 14V, 'B' Circuit

REPLACES / REEMPLAZA:

Bosch: F 00M 144 182, F 00M A45 258; **Transpo:** IB679; **AS-Poland:** ARE0202

APPLICATION / APLICACIÓN:

CASE NEW HOLLAND: T8 Agricultural Machinery (Engines Kobelco)

ALTERNATOR / ALTERNATOR:

BOSCH: 0 124 625 137, 0 124 625 058, 0 124 325 207

BOSCH
GA297

FEATURES / CARACTERÍSTICAS: 28V, 'B' Circuit

REPLACES / REEMPLAZA:

Bosch: F 00M 144 119, F 00M 145 246, F 00M A45 247, F 00M 144 119, F 00M A45 251; **Regitar:** VRB268; **Cargo:** 233117; **WAI/Transpo:** IB297, IB120

APPLICATION / APLICACIÓN:

VOLVO: B12B, FH12, FM12, FH16, FH400, FH440, FH480, FH520, FM9, FM360, FM400, FM440, FM480, NH12 Series, 9700/9900 09>

ALTERNATOR / ALTERNATOR:

BOSCH: 0 124 555 009, 0 124 555 017, 0 124 555 020, 0 124 555 028, 0 124 655 052, 0 124 655 057, 0 124 655 075, 0 124 655 103

RECTIFIER:

GA1433 / GA1448

BOSCH
GA298

FEATURES / CARACTERÍSTICAS: 28V, 'B' Circuit

REPLACES / REEMPLAZA:

Bosch: F 00M A45 253, F 00M 145 256, F 00M 145 298, F 00M 145 302, F 00M 145 307, F 00M 145 423, F 00M 144 107, F 00M 144 123; **Cargo:** 235703; **Magneti Marelli:** RT510251

APPLICATION / APLICACIÓN:

MERCEDES BENZ: 1938;

VOLVO: FH

ALTERNATOR / ALTERNATOR:

BOSCH: 0 120 000 018, 0 124 355 001, 0 124 355 002, 0 124 555 001, 0 124 555 002, 0 124 555 004, 0 124 555 007, 0 124 555 008, 0 124 555 011, 0 124 555 012, 0 124 555 015, 0 124 555 016, 0 124 555 021, 0 124 555 023, 0 124 555 025, 0 124 555 032, 0 124 555 042, 0 124 555 044, 0 124 555 045, 0 124 555 046, 0 124 655 001, 0 124 655 002, 0 124 655 004, 0 124 655 007, 0 124 655 016, 0 124 655 023, 0 124 655 038, 0 124 655 042, 0 124 655 069; **LESTER:** 12387, 12389

RECTIFIER:

GA1423 / GA1490

BOSCH
GA300

FEATURES / CARACTERÍSTICAS: 26V, 'B' Circuit

REPLACES / REEMPLAZA:

Bosch: F 00M 145 300, F 00M 144 122, F 00M 144 106; **Cargo:** 237569, **WAI/Transpo:** IB5300, **AS Poland:** ARE0086

APPLICATION / APLICACIÓN:

SCANIA: 113 F, HL, DS, DSC 04> /114 97-05 /K, R, T 12404-05 /124R06>

ALTERNATOR / ALTERNATOR:

BOSCH: 0 124 555 013, 0 124 555 014, 0 124 555 034, 0 124 555 056, 0 124 555 553, 0 124 655 009, 0 124 655 011, 0 124 655 025, 0 124 655 026, 0 124 655 047

RECTIFIER:

GA1423

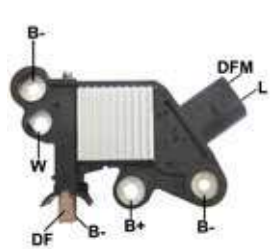
BOSCH
GA338

FEATURES / CARACTERÍSTICAS: 14V, 'B' Circuit

REPLACES / REEMPLAZA:

Bosch: 0 272 220 765

APPLICATION / APLICACIÓN:

JEEP: Renegade

FIAT: Toro

ALTERNATOR / ALTERNATOR:

BOSCH: F 000 BL0 7P3; **FIAT:** 51993773

RECTIFIER:

GA1493

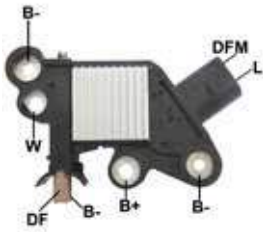
BOSCH
GA339

FEATURES / CARACTERÍSTICAS: 14V, 'B' Circuit

REPLACES / REEMPLAZA:

Bosch: 1 907 107 613, 1 275 105 104; **AS Poland:** ARE0109

APPLICATION / APLICACIÓN:

FIAT: Palio Adventure / Punto / Siena / Strada / Idea / Palio 1.6 16V 2012, Linea Punto - All / 1.6 16V E-Tork 2010>, Palio Weekend 2010-2011

ALTERNATOR / ALTERNATOR:

MAGNETI MARELLI: 51839616, 51845735; **BOSCH:** F 000 BL0 609, F 000 BL0 700

RECTIFIER:

GA1417

BOSCH
GA340

FEATURES / CARACTERÍSTICAS: 14V, 'B' Circuit, Terminals L-DFM

REPLACES / REEMPLAZA:

Bosch: F00M346340, F00M346102, F00M346011, F00M346030; **Cargo:** 333277; **WAI/Transpo:** IB6011

APPLICATION / APLICACIÓN:

CITROËN: C6 2006>2010, C6 2.7 2008>2009, C6 2006>2010;

PEUGEOT: 407 2005>2010, 407 2.7 2005, 407 2005>2010, 607 2.7 2005, A2 2.7 2004

ALTERNATOR / ALTERNATOR:

BOSCH: 0 121 715 001

BOSCH
GA342

FEATURES / CARACTERÍSTICAS: 14V, 'A' Circuit

REPLACES / REEMPLAZA:

Bosch: 0 272 220 703, 0 272 220 741, 0 272 220 684, 1 275 200 003

APPLICATION / APLICACIÓN:

FIAT: Uno / Palio / Siena / Strada >2010

ALTERNATOR / ALTERNATOR:

BOSCH: F 000 BL0 600

RECTIFIER:

GA1418

BOSCH
GA343

FEATURES / CARACTERÍSTICAS: 14V, 'B' Circuit

REPLACES / REEMPLAZA:

Bosch: F000BL9012; **VW:** 0272220701, 1275200001

APPLICATION / APLICACIÓN:

VW: Gol, Voyage, Saveiro (All V), Polo, Golf, Fox, Kombi 2006

ALTERNATOR / ALTERNATOR:

BOSCH: F000BL0300, F000BL0418; **VW:** 5U0903025E

RECTIFIER:

GA1416 | GA1492 | GA1442 | GA1413

BOSCH
GA344

FEATURES / CARACTERÍSTICAS: 14V, 'B' Circuit

REPLACES / REEMPLAZA:

Bosch: 0272220706, 0272220707, 0272220736

APPLICATION / APLICACIÓN:

Renault: Clio, Sandero, Kangoo, Duster 1.6

ALTERNATOR / ALTERNATOR:

BOSCH: F000BL0408, F000BL04F0

RECTIFIER:

GA1491

BOSCH
GA348

FEATURES / CARACTERÍSTICAS: 14V, 'B' Circuit

REPLACES / REEMPLAZA:

Bosch: F 00M 346 089, F 00M 346 013, F 00M 346 033, F 00M 346 024; **BMW:** 12317561924, 12317561939; **Transpo:** IB6024; **AS-Poland:** ARE0135; **Mobiletron:** VR-B033; **Regitar:** VRB033; **Cargo:** 330676, 333738

APPLICATION / APLICACIÓN:

BMW: 128i L6 3.0L 2008>2013, 323i L6 2.5L 2007>2009, 328i L6 3.0L 2007>2013, 328xi L6 3.0L 2007>2008, 330i L6 3.0L 2006, 330xi L6 3.0L 2006, 528i L6 3.0L 2008>2010, 528xi L6 3.0L 2009>2010, 528xi L6 3.0L 2008, X3 L6 3.0L 2007>2010, X5 L6 3.0L 2007>2008, X5 L6 3.0L GAS 2009>2010, 325i 2.5L Non-Turbo 2008>2012

ALTERNATOR / ALTERNATOR:

BOSCH: 0 121 715 012, 0 121 715 016, 0 121 715 017, 0 121 715 018, 0 121 715 112, 0 121 715 116, 0 121 715 117, 0 121 715 118

BMW: 12317550968, 12317551254, 12317551256, 12317555926, 12317542351, 12317550469, 12317558219, 12317558220, 12317560985, 12317560986

RECTIFIER:

GA1444

BOSCH
GA349

FEATURES / CARACTERÍSTICAS: 14V, 'B' Circuit

REPLACES / REEMPLAZA

Bosch: F 00M 346 135; **Transpo:** IB6135; **AS-Poland:** ARE0110; **Mobiletron:** VR-B135; **Regitar:** VRB135

APPLICATION / APLICACIÓN:

BMW: Mini One 1400/1600 16V 2010>2012, Cooper L4 1.6L 2011>2016, Cooper L4 1.6L 2011>2014, Cooper Countryman L4 1.6L 2011>2016, Cooper Countryman L4 1.6L 2011>2014, Cooper Paceman L4 1.6L 2013>2016, Countryman L4 1.6L 2011>2013

ALTERNATOR / ALTERNATOR:

BOSCH: 0 125 711 011, 0 125 711 078 **BMW:** 12317604782, 12317613445

RECTIFIER:

GA1445

BOSCH
GA352 // NEW //

FEATURES / CARACTERÍSTICAS: RVC SYSTEM

REPLACES / REEMPLAZA

Bosch: 0 272 220 776; **Mobiletron:** VR-B776

APPLICATION / APLICACIÓN:

GM: Prisma e Onix 1.0/1.4 c/ Motor ECO Automatic and Manual 2012>, Cobalt 1.8 LTZ 2016>, S10 2.5 Flex 2017>

ALTERNATOR / ALTERNATOR:

...

BOSCH
GA353

FEATURES / CARACTERÍSTICAS: 14V, 'A' Circuit

REPLACES / REEMPLAZA

Bosch: F 00M 144 147, F 00M 145 272, F 00M 145 293, F 00M 145 385; **Transpo:** IB293; **Cargo:** 237270; **Mobiletron:** VR-B385;

Regitar: VRB385; **AS-Poland:** ARE0075

APPLICATION / APLICACIÓN:

MERCEDES BENZ: C160 1800 Kompressor 2005>2008, C180 1800 2002>2007, C180 2000 2002>2004, C200 1800 Kompressor 2002>2008, C230 1800 Kompressor 2002>2005, CLK200 1800 Kompressor 2002>2006, E200 1800 2006>2010, SLK200 1800 Kompressor 2004>2010, C230 L4 1.8 2003>2005, Vaneo 2100 2004>2010, Vito 109D/111D/115D 2100 2003>2010

ALTERNATOR / ALTERNATOR:

BOSCH: 0 124 515 088, 0 124 615 028, 0 124 625 017, 0 124 625 022; **MERCEDES BENZ:** A2711540202, A2711540802

BOSCH
GA356

FEATURES / CARACTERÍSTICAS: 14V, 'B' Circuit

REPLACES / REEMPLAZA

Bosch: F 00M 145 317, F 00M 145 881, F 00M A45 222; **BMW:** 12317540657; **Transpo:** IB5881; **AS-Poland:** ARE0138

APPLICATION / APLICACIÓN:

BMW: 323i L6 2.5 2006>2007, 325i L6 3.0 2006, 325xi L6 3.0 2006, 550i V8 4.8 2006, 650i V8 4.8 2006, 750i V8 4.8 2006, 750Li V8 4.8 2006, Z4 L6 3.0 2006>2008, 130i 3000, N52 B30 2005>2007, 325 2500, N52 B25 2005>2007, 330 3000, N52 B30 2005>2007, 525 2500, N52 B25 2005>2007, 530 3000, N52 B30 2005>2010, 630 3000, N52 B30 2004>2007, Z4 3000, N52B30 2006>2010

ALTERNATOR / ALTERNATOR:

BOSCH: 0 124 525 083, 0 124 525 524; **BMW:** 12314487081, 12317542529, 12317543083

BOSCH
GA359

FEATURES / CARACTERÍSTICAS: 14V, 'A' Circuit

REPLACES / REEMPLAZA

Bosch: F 00M 145 278, F 00M 145 678, F 00M A45 218; **BMW:** 12317515811; **Transpo:** IB678; **Cargo:** 236707;

AS-Poland: ARE0079; **Mobiletron:** VR-B280; **Regitar:** VRB280

APPLICATION / APLICACIÓN:

BMW: 325Ci L6 2.5 2004>2006, 325i L6 2.5 2004>2005, 325xi L6 2.5 2004>2005, 330Ci L6 3.0 2004>2005, 330Ci L6 3.0 M54 Eng 2006, 330i L6 3.0 2004>2005, 330i L6 3.0 M54 Eng 2006, 330xi L6 3.0 2004>2005, 330xi L6 3.0 M54 Eng 2006, 530i L6 3.0 2004, X3 L6 2.5 2004>2006, X3 L6 3.0 2004>2006, 520 2200, M54 2003>2005, 525 2500, M54 2003>2010, 530 3000, M54 30 6S 3 2003>2005, 730 3000, M54 2003>2005, X3 2500, M54 25 6S 5 2005>2006, X3 3000, M54 30 6S 3 2004>2006

ALTERNATOR / ALTERNATOR:

BOSCH: 0 124 525 026, 0 124 525 080, 0 124 525 523; **BMW:** 12317519721, 12317519723, 12317521135, 12317541694, 12317541696, 12317546284, 12317546285

BOSCH
GA368

FEATURES / CARACTERÍSTICAS: 14V, 'B' Circuit

REPLACES / REEMPLAZA

Bosch: F 00M 145 289, F 00M 145 316, F 00M 145 258, F 00M 145 656, F 00M 145 882, F 00M A45 223; **BMW:** 12317540655, 7540655, 7523065; **Transpo:** IB5289; **Cargo:** 234038; **AS-Poland:** ARE0074

APPLICATION / APLICACIÓN:

BMW: X1 2.0L Turbo 2012, X1 2.0L Non-Turbo 2012>2013, 316 i 2002>2005, 318 i 2007>2011, 320 i 2006>2011

ALTERNATOR / ALTERNATOR:

BOSCH: 0 124 325 087, 0 124 325 116; **BMW:** 12317521488, 12317521489, 12317532964, 12317532968, 12317533268, 12317533272

BOSCH
GA370

FEATURES / CARACTERÍSTICAS: 14V, 'B' Circuit

REPLACES / REEMPLAZA:

Bosch: F 00M 145 321, F 00M 144 131, F 00M 145 304; **Transpo:** IB321; **Cargo:** 237816; **AS-Poland:** ARE0082;

Mobiletron: VR-B131; **Regitar:** VRB131

APPLICATION / APLICACIÓN:

RENAULT: Clio III 1400 16V 2005>2010, Clio III 1500 2005>2010, Clio III 1600 16V 2005>2010, Modus 1400 16V 2005>2010, Modus 1500 2004>2010, Modus 1600 16V 2005>2010

ALTERNATOR / ALTERNATOR:

BOSCH: 0 124 425 011, 0 124 425 013, 0 124 425 018, 0 124 425 029, 0 124 425 034, 0 124 425 037, 0 124 425 038, 0 124 425 039, 0 124 425 042, 0 124 425 045, 0 124 425 046, 0 124 425 047, 0 124 425 069, 0 124 425 070, 0 124 425 074, 0 124 425 075, 0 124 425 110

RENAULT: 8200325823

BOSCH
GA558

FEATURES / CARACTERÍSTICAS: 28V, 'B' Circuit

REPLACES / REEMPLAZA:

Bosch: 1 197 311 558, 1 197 311 554; **Cargo:** 234522; **Casco:** CRE10612AS; **CQ:** CQ1010021; **Mobiletron:** VR-B558B;

Powermax: 1113963, 81113963; **WAI / Transpo:** IB558; **Woodauto:** VRG46492; **AS Poland:** ARE0056

APPLICATION / APLICACIÓN:

MAN: Trucks

ALTERNATOR / ALTERNATOR:

BOSCH: 0 123 325 500, 0 123 525 501, 0 123 525 504

BOSCH/WAPSA
GA007

FEATURES / CARACTERÍSTICAS: 14V / 55A, 'B' Circuit

REPLACES / REEMPLAZA:

Bosch: 9 190 457 007; **Wapsa:** RWA-, T-5; **VW:** 040 903803.2; **Regitar:** VR-B102

APPLICATION / APLICACIÓN:

VW: Brasília and Kombi gas./alcohol. (Dec/83) - Gol and Saveiro all models gas/alcohol with AC, Sedan 1300/1500/1600.

ALTERNATOR / ALTERNATOR:

BOSCH: 9 120 450 998, 9 120 450 999

RECTIFIER:

GA1522

BOSCH/WAPSA
GA008

FEATURES / CARACTERÍSTICAS: 90A, 'B' Circuit, Short protection

REPLACES / REEMPLAZA:

Bosch: 9 190 457 008; **Wapsa:** RWA-, T-22; **Regitar:** GR540A; **Cargo:** 130506; **WAI/Transpo:** F540

APPLICATION / APLICACIÓN:

FORD: Truck Cargo 1218, 1415, 1418, 1519, 1521, 1618, 1621, 2218, 2319, 2321, 3021, 3223 with motor FORD 6.6 / 7.8L.

ALTERNATOR / ALTERNATOR:

BOSCH: 9 120 456 004, 9 120 456 005, 9 120 456 013, 9 120 456 024, 9 120 456 025

With adjustable voltage regulation / tiene tensión de regulaje variable.

RECTIFIER:

GA1065 / GA1529

BOSCH/WAPSA
GA008N

FEATURES / CARACTERÍSTICAS: 14V / 90A, 'B' Circuit, Short protection

REPLACES / REEMPLAZA:

Bosch: 9 190 457 008; **Wapsa:** RWA-, T-22

APPLICATION / APLICACIÓN:

FORD: Truck Cargo 1218, 1415, 1418, 1519, 1521, 1618, 1621, 2218, 2319, 2321, 3021, 3223 with motor FORD 6.6 / 7.8L.

ALTERNATOR / ALTERNATOR:

BOSCH: 9 120 456 004, 9 120 456 005, 9 120 456 013, 9 120 456 024, 9 120 456 025

Without adjustable voltage regulation / no tiene tensión de regulaje variable.

RECTIFIER:

GA1065 / GA1529

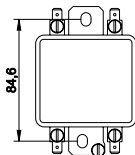
BOSCH/WAPSA
GA057

FEATURES / CARACTERÍSTICAS: 14V / 55A, 'B' Circuit, Lamp circuit

REPLACES / REEMPLAZA:

Bosch: 9 190 455 001, 9 190 455 009; **Wapsa:** RWA - W5, RWA - W7; **Magneti Marelli:** RT510091

APPLICATION / APLICACIÓN:

FORD: Corcel II, Belina II, Del Rey, Scala, Pampa (until 10.82), F-1000 /2000 /4000 /7000, F75 /100, F350 /600 /750;

DODGE: Dart, ST, RT, Charger, Trucks D100 /400 /700 /900;

VW: Trucks E11, E13, E21 6x4 Alcohol

ALTERNATOR / ALTERNATOR:

BOSCH: 9 120 450 045, 9 120 450 076, 9 120 450 097, 9 120 450 098, 9 120 450 099, 9 120 450 103, 9 120 450 111, 9 120 450 112, 9 120 450 114, 9 120 450 116, 9 120 450 117, 9 120 450 991, 9 120 450 992, 9 120 450 993

BOSCH/WAPSA
GA014

FEATURES / CARACTERÍSTICAS: 14V, 'B' Circuit

REPLACES / REEMPLAZA:

Bosch: 9 190 456 007

APPLICATION / APLICACIÓN:

VW: Brasilia, Kombi, Sedan

ALTERNATOR / ALTERNATOR:

Wapsa

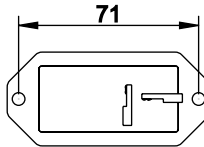
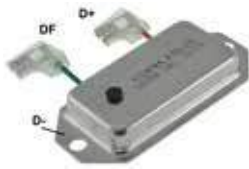
BOSCH/WAPSA
GA058

FEATURES / CARACTERÍSTICAS: 14V / 65A, 'B' Circuit

REPLACES / REEMPLAZA:

Bosch: 9 190 457 006; **Wapsa:** RWA - T1; **Regitar:** VRB213; **Cargo:** 131297; **WAI/Transpo:** IB400; **AS Poland:** ARE0071;

Magneti Marelli: RT510092

APPLICATION / APLICACIÓN:

FORD: Corcel II, Del Rey, Belina after 10.82, F1000 / F2000 / 4000 / 11000 / 13000 / 14000 / 19000 / 22000 with motor MWM 4/ 6 cil.;

VW: Trucks 6.80 (Perkins), 6.90, 7.90, 7.110, 11.130, 11.140, 12.140, 13.130 (motor MWM);

AGRALE: Tractors T4100 and T4200 (motor M790).

ALTERNATOR / ALTERNATOR:

BOSCH: 9 120 450 044, 9 120 450 071, 9 120 450 077, 9 120 450 085, 9 120 450 090, 9 120 450 092, 9 120 450 100, 9 120 450 102, 9 120 450 105, 9 120 450 107, 9 120 450 113, 9 120 450 115, 9 120 450 118, 9 120 450 119, 9 120 450 131

RECTIFIER:

GA1006

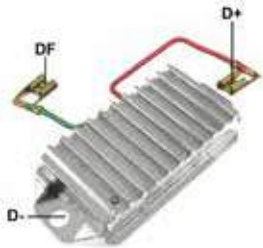
BOSCH/WAPSA
GA058R

FEATURES / CARACTERÍSTICAS: 14V / 120A, 'B' Circuit

REPLACES / REEMPLAZA:

Bosch: 9 190 457 006; **Wapsa:** RWA - T1; **Regitar:** VRB213; **Cargo:** 131297; **WAI/Transpo:** IB400; **AS Poland:** ARE0071;

Magneti Marelli: RT510092

APPLICATION / APLICACIÓN:

For adaptations vehicles for alternators until 120A

Para hacer adaptación en autos alternadores hasta 120A

ALTERNATOR / ALTERNATOR:

BOSCH: 9 120 450 044, 9 120 450 071, 9 120 450 077, 9 120 450 085, 9 120 450 090, 9 120 450 092, 9 120 450 100, 9 120 450 102, 9 120 450 105, 9 120 450 107, 9 120 450 113, 9 120 450 115, 9 120 450 118, 9 120 450 119, 9 120 450 131

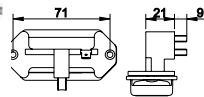
BOSCH/WAPSA
GA059

FEATURES / CARACTERÍSTICAS: 14V / 65A, 'A' Circuit

REPLACES / REEMPLAZA:

Bosch: 9 190 457 002, **Wapsa:** RWA - T2; **Regitar:** VRB213; **Cargo:** 131297; **WAI/Transpo:** IB400; **Magneti Marelli:** RT510093

APPLICATION / APLICACIÓN:

FORD: Escort L, GL, XR3, Guia with/without AC Del Rey, Pampa, Corcel II, Scala, Trucks Cargo 1218, 1415, 1418, 1618, 2218 with motor Ford 6.6;

VW: Santana, Gol, Saveiro, Voyage, Parati, Passat, Kombi Diesel, Trucks 13.210, 14.210, 15.210, 16.210, 22.210, 14.170, 16.170. All with Cummins C;

FIAT: Panorama, 147;

NEW HOLLAND: Combine 8040/ 8055.

ALTERNATOR / ALTERNATOR:

BOSCH: 9 120 450 041, 9 120 450 043, 9 120 450 073, 9 120 450 078, 9 120 450 084, 9 120 450 086, 9 120 450 087, 9 120 450 088, 9 120 450 089, 9 120 450 094, 9 120 450 096, 9 120 450 125, 9 120 450 126, 9 120 450 129, 9 120 450 133, 9 120 450 134

RECTIFIER:

GA1574

CHERY
GA106

FEATURES / CARACTERÍSTICAS: 14V, 'A' Circuit

REPLACES / REEMPLAZA:

...

APPLICATION / APLICACIÓN:

CHERY: Tiggo 2.0 2011>

ALTERNATOR / ALTERNATOR:

CHERY: B11-3701110BB, JFZ1110, 3701 AAG

CHERY
GA601

FEATURES / CARACTERÍSTICAS: 14V, 'A' Circuit

REPLACES / REEMPLAZA:

...

APPLICATION / APLICACIÓN:

Chery: Fora, M11, Tiggo

ALTERNATOR / ALTERNATOR:

Chery: JFZ1992, B11-3701110BB, 3701AAG

RECTIFIER:

GA1605

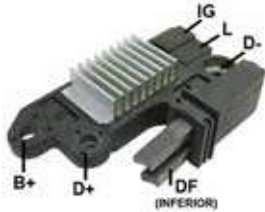
CHERY
GA602

FEATURES / CARACTERÍSTICAS: 14V, 'A' Circuit

REPLACES / REEMPLAZA:

CHERY: 11143, JFZ1753

APPLICATION / APLICACIÓN:

Chery: QQ/Face 1.1 16V

ALTERNATOR / ALTERNATOR:

Chery: S11-3701110BA, JFZ1753, 3701AAJ

RECTIFIER:

GA1602

CHERY
GA603

FEATURES / CARACTERÍSTICAS: 14 V, 'A' Circuit - Terminals B+, D+, D-, DF, IG, L

REPLACES / REEMPLAZA:

...

APPLICATION / APLICACIÓN:

Chery: QQ; Face; QQ3

ALTERNATOR / ALTERNATOR:

Chery: S12-3701110BB, 3701AAA, JFZ1721

RECTIFIER:

GA1603

CHERY
GA608

FEATURES / CARACTERÍSTICAS: 14 V, 'A' Circuit

REPLACES / REEMPLAZA:

...

APPLICATION / APLICACIÓN:

JAC: J6 Diamont 2.0 16V, Refine

ALTERNATOR / ALTERNATOR:

Chery: JFZ1929D

RECTIFIER:

GA1608

CHERY
GA898

FEATURES / CARACTERÍSTICAS: 14 V, 'A' Circuit

REPLACES / REEMPLAZA:

CHERY: JA500C03801

APPLICATION / APLICACIÓN:

JAC Motors

Effa Motors: EFFA 2006

ALTERNATOR / ALTERNATOR:

EFFA: JFZ171 JFZ1826 JFZ1826C

DAEWOO
GA400 // NEW //

FEATURES / CARACTERÍSTICAS: 14V, 'A' Circuit

REPLACES / REEMPLAZA:

Cargo: 234306; **AS-Poland:** ARE1052; **Transpo:** D404; **Era:** 215102

APPLICATION / APLICACIÓN:

CHEVROLET: Lacetti 1.8 2005, Lacetti estate 1.8 2005, Rezzo 2.0 2005>2008;

DAEWOO: Leganza 2.2 1999>2002, Leganza 2.0 2000 16V 1997>2002, Nubira saloon 2.0 16V 1997>2002, Nubira wagon 2.0 16V 1997>2002, Rezzo 1.8/2.0 2000>2005, Tacuma 2000 2000>2005

ALTERNATOR / ALTERNATOR:

Chevrolet/ Daewoo: 96206871, 96341300

DAEWOO
GA940

FEATURES / CARACTERÍSTICAS: 14V / 65A, 'A' Circuit

REPLACES / REEMPLAZA:

Daewoo: 271710, 93740796; **Cargo:** 139468; **Transpo:** D910

APPLICATION / APLICACIÓN:

DAEWOO: Matiz; **GM:** Mercury Marine V8

ALTERNATOR / ALTERNATOR:

DAEWOO: 219170

DELCO: 219292

DELCO
GA109

FEATURES / CARACTERÍSTICAS: 28V, 'A' Circuit

REPLACES / REEMPLAZA:

Delco: 7.073.864

APPLICATION / APLICACIÓN:

HYUNDAI: Mini-escavator R80

VARIOUS: Bulldozer Doosan

ALTERNATOR / ALTERNATOR:

HYUNDAI: rk390114, k1010702, 30090100034, A00001

DELCO
GA198 // NEW //

FEATURES / CARACTERÍSTICAS: 14V, 'A' Circuit

REPLACES / REEMPLAZA:

Valeo: A564796A; **Mobileron:** VR-D674H; **Regitar:** D674; **AS-Poland:** ARE1009; **Cargo:** 132930; **Transpo:** DE605

APPLICATION / APLICACIÓN:

OPEL: Astra Mk3 1400 1992>1995, Corsa B 1200 X12SZ 1993>1994

ALTERNATOR / ALTERNATOR:

OPEL: 1204217, 1204218, 1204219

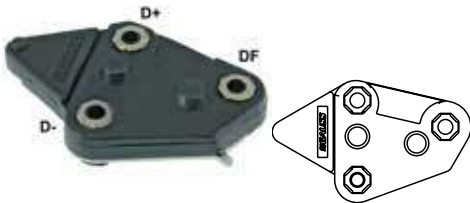
DELCO
GA199

FEATURES / CARACTERÍSTICAS: 14V / 55A, 'A' Circuit

REPLACES / REEMPLAZA:

Delco: 7.073.864

APPLICATION / APLICACIÓN:

FIAT: Uno, Prêmio, Fiorino, Fiat 147.

ALTERNATOR / ALTERNATOR:

DELCO: Several

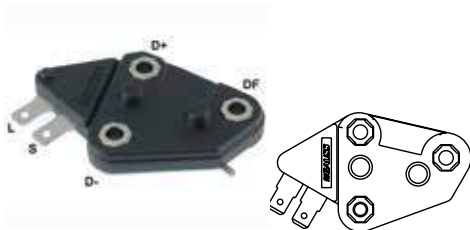
DELCO
GA200

FEATURES / CARACTERÍSTICAS: 14V / 55A, 'A' Circuit

REPLACES / REEMPLAZA:

Delco: 1116380, 1116384, 1116385, 1116387, 1116423, 1116392; **GM:** 94.655.898, 93.345.333;

Regitar: D689, D689L; **Cargo:** 130668, 233738, 233931; **WAI/Transpo:** DE607, D10, D101, D101HD, D101HDB200, D10AC, D10AC132, D10SE12, D10SE132, D10SE138; **AS Poland:** ARE1001, **Huco/Hitachi:** 130001; **Magneti Marelli:** RT510108

APPLICATION / APLICACIÓN:

GM: Opala, Caravan (75>84), Marajó, Chevy, Chevette with Alternator Delco / Arno until 55A.

ALTERNATOR / ALTERNATOR:

DELCO: 347.2004, 347.2008, 347.2014, 347.2018, 347.2022, 347.2023, 347.2024, 347.2026, 347.10SI, 347.12SI, 347.15SI, 347.17SI, 347.27SI

RECTIFIER:

GA1312

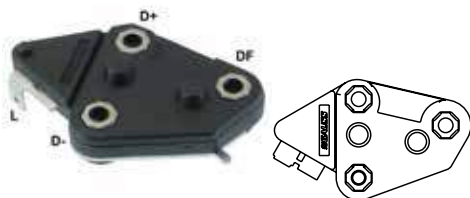
DELCO
GA201

FEATURES / CARACTERÍSTICAS: 14V / 65A, 'A' Circuit

REPLACES / REEMPLAZA:

Delco: 94.648.534; **GM:** D673; **Regitar:** D671; **Cargo:** 130666; **WAI/Transpo:** DE609; **Magneti Marelli:** RT510109

APPLICATION / APLICACIÓN:

GM: Monza, Opala, Kadett, Chevette, Utilitários S., All with Alternator Delco / Arno until 65A.

ALTERNATOR / ALTERNATOR:

DELCO: 7982674, 7982675, 7982698, 7982699, 7982703, 7982704, 7982705, 7982707, 7982710, 7982720, 7982763, 7982811, 7982812, 7982822, 7982988, 7982994, 7982995, 93153009, 93153026

RECTIFIER:

GA1311

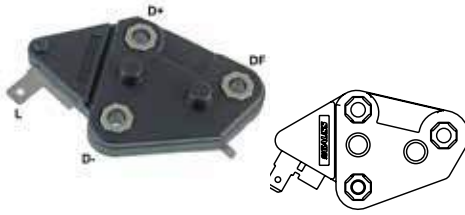
DELCO
GA202

FEATURES / CARACTERÍSTICAS: 14V / 55A, 'A' Circuit

REPLACES / REEMPLAZA:

Delco: 94.652.566; **Regitar:** D100; **Cargo:** 233737; **WAI/Transpo:** DE608; **AS Poland:** ARE1022; **Magneti Marelli:** RT510110

APPLICATION / APLICACIÓN:

GM: Chevette with alternator Delco 28/32/55A (after 85), Opala/ Utilities S and C10 with Alternator Delco.

ALTERNATOR / ALTERNATOR:

DELCO: Several

RECTIFIER:

GA1312

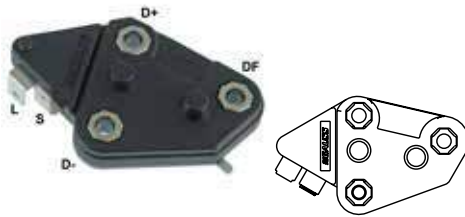
DELCO
GA203

FEATURES / CARACTERÍSTICAS: 14V / 65A, 'A' Circuit

REPLACES / REEMPLAZA:

Delco: 94632541, 94648534; **Regitar:** D673; **Cargo:** 131044; **WAI/Transpo:** DE606; **AS Poland:** ARE1010, **Huco/Hitachi:** 130004; **Magneti Marelli:** RT510111

APPLICATION / APLICACIÓN:

GM: Monza with Alternator Delco.

ALTERNATOR / ALTERNATOR:

DELCO: 347.2020, 347.021, 347.028, 347.032, 347.033, 347.037, 347.038, 347.042, 347.048, 347.2051, 347.052, 347.053, 347.058, 347.059, 347.060, 347.061, 347.049, 347.050

RECTIFIER:

GA1311

DELCO
GA205

FEATURES / CARACTERÍSTICAS: 14V / 55A, 'A' Circuit

REPLACES / REEMPLAZA:

Delco: 1116435, 1116389, 1116433, D669; **Regitar:** D583, D686, D680; **Cargo:** 139637, 134750; **WAI/Transpo:** D102HD, D102HD1, D22AC1, D27, D27A; **AS Poland:** ARE1034; **Mobiletron:** VR-D583, VR-D680, VR-D686, VR-D669C, VR-D718

APPLICATION / APLICACIÓN:

GM; Imported: Bobcat, Bowers, Case, Caterpillar, Cummins, Hyster, IHC, Navistar, John Deere, Mack Truck, Massey Ferguson, New Holland, Versatile, Western Star, White;

CAMECO: Sugar Cane Harvester;

CUMMINS: Series C and K; Encava engine 6CTAA front;

ENCAVA: Engine Cummins 6CTAA front;

INGERSOLL RAND: Ingersoll Rand with engines Cummins B and C;

INTERNATIONAL: Trucks series 4000 and 9000; Trucks series 9000 with engine Cummins M11;

AGRALE: Bus CIV and EPA185 ISB;

MACK: Trucks Pinnacle, TerraPro, Granite. Fix PAD with 4 square tabs;

VOLVO: Trucks VN, VNL 430, VNL 630, VNL 730, VNM 430, VHD squared with 4 assembling PADs;

NAVISTAR: Trucks Prostar, Transtar squared with 4 assembling PADs; Workstar 7300, 7400, 7600, Paystar, Durastar 4200 - 4300, 4400 squared with 4 assembling PADs;

FREIGHTLINER: M2 106, M2 112, Cascadia, Coronado (8600203 STD original), Severe Duty, FCC Walk in Van, FCCC Shuttle Bus - Fix PAD 4 squared with 4 assembling PADs;

ALTERNATOR / ALTERNATOR:

DELCO: 10SI 116, 20SI, 22SI, 27SI 200, 30SI, 35SI, 40SI, 10459004, 10459008, 10459009, 10463072, 10463074, 10497177, 1100072, 1100073, 19010196, 19011154, 19011169, 19011224, 19011225, 19011226, 19011231, 19011233, 19011246, 19011247, 19011255, 19011258, 19011260, 19011261, 19011262, 19011263, 19011264, 19011265, 19011266, 19011267, 19011268, 19011269, 19011272, 19011273, 19011275, 19011276, 19011277, 19020304, 19020305, 19020801, 19020803, 19020804, 8600060, 8600071, 8600072, 8600073, 8600159, 8600160, 8600161, 8600162, 8600178, 8600197, 8600202, 8600203, 8600221, 8600244, 8600246, 8600247, 8600248, 8600252, 8600362, 8600337, 8600367, 8600341, 8600409, 8600427, 8600428, 8600472, 8600488

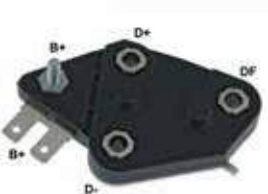
DELCO
GA206

FEATURES / CARACTERÍSTICAS: 28V / 110A, 'A' Circuit

REPLACES / REEMPLAZA:

Delco: 1105510, 1116388, 1984287, 1987518, 1116404, 1116405, 1894460; **Regitar:** D687, D688; **Cargo:** 134751, 130510, **WAI/Transpo:** 13650D, D30, D30A, D30S, D104HD, D104HD1; **AS Poland:** ARE1002, **Huco/Hitachi:** 130018

APPLICATION / APLICACIÓN:

Vehicles with 28V Delco Alternators: 20 SI, Atlas Copco XAMS355 and XAS400; **CATERPILLAR:** 508, 518, 528, 561D, 571G, 572G, 583K, 589, 591, 594H, 814, 814B, 815, 815B, 816, 816B, 824B, 824C, 825, 825C, 826, 916, 920, 926, 930, 936, 941B, 943, 950B, 951, 953, 955L, 963, 966C, 966D, 966F, 973, 977L, 980B, 980C, 983, 983B, 3208, 3304, 3306, 3406, 3408, 3412, 3508, 3516, D10N, D4D, D4E, D4H, D5, D5B, D6C, D6D, D6H, D7G, D7H, D8K, D8L, D8N, D9H, D9L, D9N, IT 14B, IT 18B, IT 28B; **CUMMINS series:** 855, B, C, K, L and V; **CUMMINS 21 SI alternators:** C and K series; **TIMBERJACK:** 608, 618, 628, 2618, 2628

ALTERNATOR / ALTERNATOR:

DELCO: 10SITYPE116, 1100077, 1100078, 11000211, 1101285, 1102916, 1102918, 1102919, 102934, 1103123.

DELCO
GA207

FEATURES / CARACTERÍSTICAS: 32V, 'A' Circuit, Ajustable

REPLACES / REEMPLAZA:
Delco: 10474943; **Cargo:** 235671; **WAI/Transpo:** D32S

APPLICATION / APLICACIÓN:
32V alternators, railway application; Caterpillar; Cummins
ALTERNATOR / ALTERNATOR:
DELCO: 1117733, 1117747, 30SI 32V

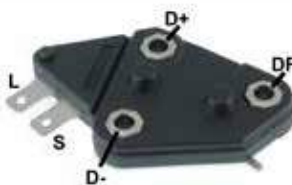
DELCO
GA209

FEATURES / CARACTERÍSTICAS: 14V, 'A' Circuit

REPLACES / REEMPLAZA:
Delco: 1116439; **Regitar:** D682; **Cargo:** 139637, 233204; **WAI/Transpo:** D21N, D21N1

APPLICATION / APLICACIÓN:
BLUE BIRDS BUS: All Models (By Engine) Caterpillar 3116 & 3126 1992-1996;

CHEVROLET MEDIUM/HEAVY TRUCK: B60 8 Cyl. 8.2L 501cid DD 8.2L (N, T) 1992-1993, B60 V8 8.2L 501cid DD 8.2L (N, T) 1989-1991, C50 Caterpillar 3116 1991-1993, C5500 Kodiak Caterpillar 3116 1990-1993, C60 Kodiak L6 6.6L 403cid Caterpillar 3116 1990-1993, C6500 Kodiak Caterpillar 3116 1990-1993, C70 Kodiak L6 6.6L 403cid Caterpillar 3116 1990-1993, C7500 Kodiak Caterpillar 3116 1990-1993, C80 Caterpillar 3116 1990-1993, Kodiak C8500 Caterpillar 3116 1990-1993, P6000 DD 8.2L (N, T) 1989-1993, S7 V8 8.2L 501cid 1989-1990, S7 Series GM 8.2L (N,T) Dsl 1991-1993, B7 6 Cyl. 6.6L 403cid Caterpillar 3116 1999-2002, B7 L6 6.6L 403cid Caterpillar 3116 1994-1998, B7 L6 7.2L 441cid Caterpillar 3126 1998-2002, C4500 Kodiak Caterpillar 3116 1997-2002, C4500 Kodiak Caterpillar 3126 1998-2002, C4500 Kodiak Caterpillar C7 1997-2002, C50 Caterpillar 3116 1994-2002, C50 Caterpillar 3126 1998-2002, C5500 Kodiak Caterpillar 3116 1994-2002, C5500 Kodiak Caterpillar 3126 1998-2002, C5500 Kodiak Caterpillar C7 1997-1999, C60 Kodiak L6 6.6L 403cid Caterpillar 3116 1994-1996, C6500 Kodiak 6 Cyl. 7.2L 441cid Caterpillar 3126 1998, C6500 Kodiak 6 Cyl. 7.2L 441cid Caterpillar C7 1997-1998, C6500 Kodiak L6 6.6L 403cid Caterpillar 3116 1997-1998, C6500 Kodiak L6 7.2L 441cid Caterpillar 3126 1999-2002, C6500 Kodiak L6 7.2L 441cid Caterpillar C7 1999-2002, C70 Caterpillar 3116 1994-2002, C70 Caterpillar 3126 1998-2002, C70 Kodiak L6 6.6L 403cid Caterpillar 3116 1994-1996, C7500 Kodiak 6 Cyl. 7.2L 441cid Caterpillar 3126 1998, C7500 Kodiak Caterpillar 3116 1994-1996, C7500 Kodiak Caterpillar 3116 2001-2002, C7500 Kodiak L6 6.6L 403cid Caterpillar 3116 1997-1998, C7500 Kodiak L6 7.2L 441cid Caterpillar 3126 1999-2002, C7500 Kodiak L6 7.2L 441cid Caterpillar C7 2001-2002, C80 Caterpillar 3116 1994-2000, C80 Caterpillar 3126 1998-2002, F6 Series Caterpillar 3116 1997-1998, F7 Series Caterpillar 3116 1997-1998, Kodiak C8500 Caterpillar 3116 1994-2002, Kodiak C8500 Caterpillar 3126 1998-2002, Kodiak C8500 Caterpillar C7 1997-2002, P6000 L6 6.6L 403cid Caterpillar 3116 1995-1996, T5500 Caterpillar 3116 1997-1998, T5500 Caterpillar 3126 1997-2002, T6500 L6 6.6L 403cid Caterpillar 3116 1997-1998, T6500 L6 7.2L 441cid Caterpillar 3126 1998-2002, T7500 6 Cyl. 7.2L 441cid Caterpillar 3126 1997, T7500 L6 6.6L 403cid Caterpillar 3116 1997-1998, T7500 L6 7.2L 441cid Caterpillar 3126 1998-2002, T8500 Series Caterpillar 3116 1997-1998, T8500 Series Caterpillar 3126 1997-2002, C4500 Topkick Caterpillar C7 1997-2002, C5000 Caterpillar 3116 1994-2002, C5000 Caterpillar 3126 1998-2002, C5500 Topkick Caterpillar 3116 1994-2002, C5500 Topkick Caterpillar 3126 1998-2002, C5500 Topkick Caterpillar C7 1997-2002, C6000 Caterpillar 3116 1994-2002, C6000 Caterpillar 3126 1998-2002, C6000 Topkick L6 6.6L 403cid Caterpillar 3116 1994-1996, C6500 Topkick 6 Cyl. 6.6L 403cid Caterpillar 3116 1994-1996, C6500 Topkick 6 Cyl. 6.6L 403cid Caterpillar 3116 1999-2002, C6500 Topkick 6 Cyl. 7.2L 441cid Caterpillar 3126 1997-1998, C6500 Topkick L6 6.6L 403cid Caterpillar 3116 1997-1998, C6500 Topkick L6 7.2L 441cid Caterpillar 3126 1999-2002, C7000 Caterpillar 3116 1994-2002, C7000 Caterpillar 3126 1998-2002, C7000 Topkick L6 6.6L 403cid Caterpillar 3116 1994-1996, C7500 Topkick 6 Cyl. 7.2L 441cid Caterpillar 3126 1998, C7500 Topkick 6 Cyl. 7.2L 441cid Caterpillar C7 1997-1998, C7500 Topkick Caterpillar 3116 1994-1996, C7500 Topkick L6 6.6L 403cid Caterpillar 3116 1997-1998, C7500 Topkick L6 7.2L 441cid Caterpillar 3126 1999-2002, C7500 Topkick L6 7.2L 441cid Caterpillar C7 1999-2002, P6500 L6 6.6L 403cid Caterpillar 3116 1995-1996, T6500 6 Cyl. 7.2L 441cid Caterpillar 3126 1997, Topkick C8500 Caterpillar 3116 1994-2002, Topkick C8500 Caterpillar 3126 1998-2002, Topkick C8500 Caterpillar C7 1997-2002;

CHEVROLET VAN: P20 DD 8.2L (N, T) 1989, P30 Caterpillar 3116 1991-1993, P30 DD 8.2L (N, T) 1989-1993;

GMC MEDIUM/HEAVY TRUCK: B6000 8 Cyl. 8.2L 501cid DD 8.2L (N, T) 1992-1993, B6000 V8 8.2L 501cid DD 8.2L (N, T) 1989-1991, C5000 Caterpillar 3116 1991-1993, C5500 Topkick Caterpillar 3116 1990-1993, C6000 Topkick L6 6.6L 403cid Caterpillar 3116 1990-1993, C6500 Topkick Caterpillar 3116 1990-1993, C7000 Topkick L6 6.6L 403cid 1990-1993, C7500 Topkick Caterpillar 3116 1990-1993, C80 Caterpillar 3116 1990-1993, P6500 DD 8.2L (N, T) 1989-1993, S7 GM 8.2L (N,T) Dsl 1989-1993, Topkick C8500 Caterpillar 3116 1990-1993;

GMC VAN: P2500 DD 8.2L (N, T) 1989, P3500 Caterpillar 3116 1991-1993, P3500 DD 8.2L (N, T) 1989-1993;

FREIGHTLINER MEDIUM/HEAVY TRUCK: Argosy Caterpillar C15 1999-2012, Argosy Cummins ISX15 1999-2012, Argosy L6 11.1L 11096cc 677cid 2000-2012, Argosy L6 11.1L 11096cc 677cid DD60 1999;

PETERBILT HEAVY DUTY: 362 Series Cummins N14 14.0L 1995-2012, 377 A/E Cummins N14 14.0L 1996-2012

ALTERNATOR / ALTERNATOR:
DELCO: 19010112

CUMMINS: 3675156RX, 3675157RX, 3675159RX, 3675225RX, 4083445.

RECTIFIER:

GA1798

DELCO
GA210

FEATURES / CARACTERÍSTICAS: 14V, 'A' Circuit

REPLACES / REEMPLAZA:
Delco: 7934605, 7982614, 7982866 ; **Transpo:** DE604; **Regitar:** D670; **Cargo:** 130664

APPLICATION / APLICACIÓN:
DELCO: Delco Alternators

ALTERNATOR / ALTERNATOR:

-

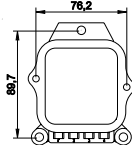
DELCO
GA204

FEATURES / CARACTERÍSTICAS: 14V / 55A, 'B' Circuit, Short protection

REPLACES / REEMPLAZA:

Delco: 1119506, 119512, 1119515, D635, D663; **Regitar:** D635; **Cargo:** 130505; **WAI/Transpo:** D9212, D9212S;

Magneti Marelli: RT510112

APPLICATION / APLICACIÓN:

GM: Opala/ C-10 Cil. until 74, C-10 - 6 Cil. D-10 and D-70 all

ALTERNATOR / ALTERNATOR:

DELCO: 10 DN / 20 DN Séries, 1100558, 1100568, 1100567, 1100569, 1100570, 1100571, 1100572, 1100590, 1100591, 1100600, 1100605, 1100615.

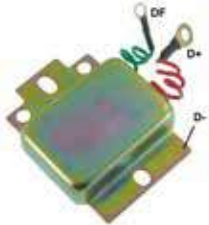
DELCO
GA236

FEATURES / CARACTERÍSTICAS: 28V / 35A, 'B' Circuit

REPLACES / REEMPLAZA:

Delco: 1117236, **Caterpillar:** 2P1699, 952329, 6N3821; **Regitar:** VRP393; **Cargo:** 131687; **WAI/Transpo:** P8393, P8393A

APPLICATION / APLICACIÓN:

CATERPILLAR: Tractors, Loaders, Motor Graders.

ALTERNATOR / ALTERNATOR:

2P1204.

DELCO
GA408

FEATURES / CARACTERÍSTICAS: 14V, LRC: 2.5S, Terminals: PLFS, 'B' Circuit

REPLACES / REEMPLAZA:

Delco: 1116408, 116428, D675, D699; **Regitar:** D675; **Cargo:** 131904; **WAI/Transpo:** 351171, D408XHD; **Magneti Marelli:** RT510150

APPLICATION / APLICACIÓN:

GM: Monza, Ómega - alternators Delco CS130 / CS 144, Pick-up.

ALTERNATOR / ALTERNATOR:

DELCO: Series CS 130/CS 144, 10456319, 10456332, 10463069, 10463071, 10463446, 10479843, 10480011, 10480012, 10480033, 10480034, 10480131, 10481034.

RECTIFIER:

GA1802

DELCO
GA409

FEATURES / CARACTERÍSTICAS: 14V 'B' Circuit

REPLACES / REEMPLAZA:

Delco: 1116412, 1116434, D678, D684, 19009712; **Regitar:** D412; **Cargo:** 131906; **WAI/Transpo:** D412, D712; **AS Poland:** ARE1013

APPLICATION / APLICACIÓN:

BUICK: Riviera, Cadillac Allante;

OLDSMOBILE: Aurora

ALTERNATOR / ALTERNATOR:

DELCO: 10463070, 10463409, 10463606, 10463646, 10463689, 10463691, 10464435, 10480018, 10480019, 10480120, 10480177, 10480186, 10480204, 10480276, 10480279, 10480282, 1101133, 1101270, 1101295, 1101330, 1101574, 101591, 1101850, 3211029, 3211071, 3211106, 321368, 321485; **LESTER:** 7863, 78632, 7942, 7986, 8113, 811311, 8174, 8183, 81835, 81915; **PIC:** 2405402, 2405405, 2405420, 2405464, 2405473

DELCO
GA410

FEATURES / CARACTERÍSTICAS: 14V 'B' Circuit

REPLACES / REEMPLAZA:

Delco: 1116413, 1116430, D600A, D681, 413; **Cargo:** 133582; **WAI/Transpo:** D445XHD

APPLICATION / APLICACIÓN:

CADILAC; GM: Omega with AC.; Delco CS 130/ CS 144 Alternators

ALTERNATOR / ALTERNATOR:

DELCO: 10463096, 10463108, 10463119, 10463121, 10463122, 10463189, 10463190, 10463201, 10463295, 10463442, 10479884, 10479995, 10479996, 10480008, 10480009, 10480048, 10480116, 10480172, 10880227, 1101284, 1101296, 1101350, 1101490, 1101518, 1101519, 1101578, 1101579, 1101623, 1101847, 3211006, 321387, 321399, 321410, 321412, 321413, 321481, 321482, 321492, 321580, 321581; **LESTER:** 7806, 79185, 79422, 79662, 79692, 8127, 812711, 8131, 8132, 8170, 817011, 81897; **PIC:** 2405225, 2405415, 2405418, 2405440, 2405458, 2405460, 2405470, 2405472, 2405474

DELCO
GA411

FEATURES / CARACTERÍSTICAS: 14V, LRC: 2.5S, Terminals: P.L.I.G.S, 'B' Circuit

REPLACES / REEMPLAZA:

Delco: 1116411, 1116429, 1116436, 1116437, D411, D677, D685, D698; **Regitar:** D694HD; **Cargo:** 131905; **WAI/Transpo:** D411HD; **AS Poland:** ARE1003; **Magneti Marelli:** RT510153

APPLICATION / APLICACIÓN:

GM: Monza, Ómega, Kadett;

DAEWOO; SATURN; TOYOTA; JEEP

ALTERNATOR / ALTERNATOR:

DELCO: CS121, CS130, CS144, 10430484, 10456300, 10456301, 10456302, 10456303

RECTIFIER:

GA1658

DELCO
GA412

FEATURES / CARACTERÍSTICAS: 14V 'B' Circuit

REPLACES / REEMPLAZA:

Delco: 1116425, 13148399, D683, 425, DE125; **Cargo:** 133581; **WAI/Transpo:** D425XHD

APPLICATION / APLICACIÓN:

Delco: CS144 alternators, RV, Industrial

ALTERNATOR / ALTERNATOR:

DELCO: 10463126, 10463140, 10463144, 10463145, 10463151, 10463183, 10463197, 10463199, 10463210, 10463300, 10463535, 10463620, 10479852, 10479959, 10479976, 10480022, 10480023, 10480062, 10480088, 10480089, 10480093, 10480098, 10480099, 10480156, 10480192, 10480267, 10480269, 1101478, 1101480, 1101482, 1101561, 1101566, 1101571, 1101625, 1101806, 1101818, 1102605, 1102616, 1102635, 3211039, 3211040, 3211045, 3211065, 3211083, 3211116, 321417, 321431, 321435, 321436, 321442, 321475, 321489, 321491, 321498, 321501, 321586

DELCO
GA413

FEATURES / CARACTERÍSTICAS: 14V 'B' Circuit

REPLACES / REEMPLAZA:

Delco: 1116440; **Regitar:** D440; **Cargo:** 233203; **WAI/Transpo:** D440; **AS Poland:** ARE2012

APPLICATION / APLICACIÓN:

TOYOTA: 89-91 Geo Prizm 1.6, 91-93 Toyota Camry, Corolla 1.6 & 1.8 L w/Cs121 units.

ALTERNATOR / ALTERNATOR:

DELCO: 2405190, 2405191, 2405192, 2405193, 2405550, 2405551; **TOYOTA:** 2706002050, 2706074200

DELCO
GA414

FEATURES / CARACTERÍSTICAS: 14V, 'B' Circuit

REPLACES / REEMPLAZA:

Delco: 1116445; **Regitar:** D445; **Cargo:** 133582; **WAI/Transpo:** D445, D445XHD; **AS Poland:** ARE1014

APPLICATION / APLICACIÓN:

BUICK;
OLDSMOBILE;
PONTIAC;

ALTERNATOR / ALTERNATOR:

DELCO: 10464079, 10464088, 10480055, 10480205, 10480227, 10480265, 10480278, 10480296, 10480297, 10480310, 10480311, 10480347, 10480363, 3211427; **LESTER:** 8213, 82137, 8226, 8248; **PIC:** 2405389, 2405395, 2405443B

DELCO
GA415

FEATURES / CARACTERÍSTICAS: 14V, 'B' Circuit

REPLACES / REEMPLAZA:

Delco: 1116446, D602A; **Regitar:** D602R; **Cargo:** 232413; **WAI/Transpo:** D446XHD

APPLICATION / APLICACIÓN:

BUICK;
OLDSMOBILE;
PONTIAC;

ALTERNATOR / ALTERNATOR:

DELCO: 10480135, 10480171; **LESTER:** 81925, 81935; **PIC:** 2405499, 2406201

DELCO
GA416

FEATURES / CARACTERÍSTICAS: 14V, 'A' Circuit

REPLACES / REEMPLAZA:

Delco: 276010; **Regitar:** D276; **Cargo:** 139467; **WAI/Transpo:** D403; **AS Poland:** ARE1012

APPLICATION / APLICACIÓN:

Korea Daewoo

ALTERNATOR / ALTERNATOR:

DELCO: 96224431, 96224432

DELCO
GA424

FEATURES / CARACTERÍSTICAS: 14V, 'B' Circuit

REPLACES / REEMPLAZA:

Delco: 1116424; **Regitar:** D424; **Cargo:** 134343; **WAI/Transpo:** D424; **Magneti Marelli:** RT510159

APPLICATION / APLICACIÓN:

OPEL: Astra F 1.8i / 2.0i, Omega 1.8 / 2.0, Vectra 1.8 / 2.0, Kadett 2.0i, Gsi, Frontera 2.0i;

VAUXHALL: Carlton 1.8, 2.0i

ALTERNATOR / ALTERNATOR:

DELCO: 1101551, 1101196

DELCO
GA432

FEATURES / CARACTERÍSTICAS: 14V, 'B' Circuit

REPLACES / REEMPLAZA:

Delco: 1116432; **Regitar:** D432; **Cargo:** 133589; **WAI/Transpo:** D432; **AS Poland:** ARE1017; **Magneti Marelli:** RT510160

APPLICATION / APLICACIÓN:

GM: Monza, Omega CD 4.1, Kadett, Vectra, S10;

DAEWOO;

PONTIAC: Le mans;

OPEL;

SUZUKI;

ALTERNATOR / ALTERNATOR:

DELCO: 10463134, 1101219, 321425; **LESTER:** 7954; **PIC:** 2405532

RECTIFIER:

GA1658 / GA1714

DELCO
GA701

FEATURES / CARACTERÍSTICAS: 14V, 'A' Circuit

REPLACES / REEMPLAZA:

Delco: 19009701, 10475019, 10479914, 10479923, 10479947, 10479955, 1204270; **GM:** 140475019; **Opel:** 1204270, DE 701;

Regitar: D701; **Cargo:** 135336; **WAI/Transpo:** DE701; **AS Poland:** ARE1005; **Magneti Marelli:** RT510175

APPLICATION / APLICACIÓN:

GM: Omega, Corsa Wind, Vectra after 95, Astra, Frontera, Tigra.

ALTERNATOR / ALTERNATOR:

DELCO: Series IR/IF/ 10479914/ 923/ 947/ 955, QY6J5, 3493814, 3493823, 3493847, 3493855, 6204002, 6204006, 6204007, 6204008.

RECTIFIER:

GA1714

DELCO
GA718

FEATURES / CARACTERÍSTICAS: 14V, 'B' Circuit

REPLACES / REEMPLAZA:

Delco: 19009708; **Opel:** 1204288; **GM:** 10493240; **Regitar:** D711; **Cargo:** 231796; **WAI/Transpo:** DE708

APPLICATION / APLICACIÓN:

GM

ALTERNATOR / ALTERNATOR:

GM: 90543910, 6204072

DELCO
GA702

FEATURES / CARACTERÍSTICAS: 14V, 'B' Circuit, LRC: 2,5S, Terminals: P.L.IG.S

REPLACES / REEMPLAZA:

Delco: 19009702; **Cargo:** 135547; **Regitar:** D702; **Cargo:** 235614, 135547, 233776; **WAI/Transpo:** D702SE, D720XHD;

Mobiletron: VR-D702H; **Magneti Marelli:** RT510176

APPLICATION / APLICACIÓN:

GM: Omega (with AC.), Corsa, Vectra.

ALTERNATOR / ALTERNATOR:

DELCO: Series CS121D /CS130D, 10463407, 10463443, 10463654, 10470119, 10479981, 10479984, 10480017, 10480052.

RECTIFIER:

GA1758

DELCO
GA703

FEATURES / CARACTERÍSTICAS: 14V, 'B' Circuit

REPLACES / REEMPLAZA:

Delco: 19009705; **Regitar:** D709R; **Cargo:** 231184; **WAI/Transpo:** D705XHD

APPLICATION / APLICACIÓN:

BUICK: Skylark;

CHEVROLET: Cavalier, Pontiac Grand-Am, Sunfire

ALTERNATOR / ALTERNATOR:

DELCO: 10480074, 10480076, 10480079, 10480184, 10480191, 10480207, 10480217, 10480218, 10480251, 10480252, 10480299, 10480301; **LESTER:** 819011, 8197, 81977, 8222, 8223, 8224, 8229, 8230, 8231, 8233, **PIC:** 2406140, 240615

DELCO
GA704

FEATURES / CARACTERÍSTICAS: 14V, 'B' Circuit

REPLACES / REEMPLAZA:

Delco: 19009703; **Regitar:** D703; **Cargo:** 231183; **WAI/Transpo:** D703; **AS Poland:** ARE1019

APPLICATION / APLICACIÓN:

GM: S10, Pick-up;

RENAULT: Clio, Kangoo, Twingo

ALTERNATOR / ALTERNATOR:

DELCO: 10463630, 10463966, 10464075, 10480043, 10480182, 10480264, 3211048, 3211310; **LESTER:** 81585, 8200, 820011; **PIC:** 2406137, 2406138, 2406180

RECTIFIER:

GA1758

DELCO
GA706

FEATURES / CARACTERÍSTICAS: 14V, 'B' Circuit

REPLACES / REEMPLAZA:

Delco: 19009706; **Regitar:** D706; **Cargo:** 231185; **WAI/Transpo:** D706

APPLICATION / APLICACIÓN:

CHEVROLET: P Series Step Van, GMC Series Step Van

ALTERNATOR / ALTERNATOR:

DELCO: 10480170, 3211130; **LESTER:** 8216

DELCO
GA707

FEATURES / CARACTERÍSTICAS: 14V, 'B' Circuit

REPLACES / REEMPLAZA:

Delco: 19009719; **Regitar:** D702; **Cargo:** 235614; **WAI/Transpo:** D702SE

APPLICATION / APLICACIÓN:

GM: Vehicles

ALTERNATOR / ALTERNATOR:

DELCO: 10464407, 10464457, 10480343, 15757624

RECTIFIER:

GA1758

DELCO
GA708

FEATURES / CARACTERÍSTICAS: 14V, 'B' Circuit

REPLACES / REEMPLAZA:

Delco: 19009729; **Regitar:** D709R; **Cargo:** 231184; **WAI/Transpo:** D705XHD

APPLICATION / APLICACIÓN:

GM: Vehicles

ALTERNATOR / ALTERNATOR:

DELCO: 10464415, 10464423, 10464431, 10464432, 10480320, 10480346, 10480361, 10480362, 3211759; **LESTER:** 8228, 8275, 8276 **PIC:** 2406140B, 2406144A, 2406173A

DELCO
GA709

FEATURES / CARACTERÍSTICAS: 14V, 'B' Circuit

REPLACES / REEMPLAZA:

Delco: 19009734; **Cargo:** 231183; **WAI/Transpo:** D734; **AS Poland:** ARE1019

APPLICATION / APLICACIÓN:

CHEVROLET: Camaro, **PONTIAC:** Firebird

ALTERNATOR / ALTERNATOR:

DELCO: 10464409, 10480307, 3211756; **LESTER:** 8200L; **PIC:** 2406135

DELCO
GA710

FEATURES / CARACTERÍSTICAS: 14V, 'B' Circuit

REPLACES / REEMPLAZA:

Delco: 19009761; **Cargo:** 233251; **WAI/Transpo:** D749XHD

APPLICATION / APLICACIÓN:

BUICK: Regal, Pontiac Grand Prix

ALTERNATOR / ALTERNATOR:

DELCO: 10464413, 10464424, 10464427, 10464437, 10464462, 10480288, 10480318, 10480331, 10480336, 10480378, 3211757; **LESTER:** 8243, 8270, 8271, 8272, 8283; **PIC:** 2406137B, 2406181, 2406405, 2406450, 2406451

DELCO
GA711

FEATURES / CARACTERÍSTICAS: 14V, 'B' Circuit

REPLACES / REEMPLAZA:

Delco: 19009749; **WAI/Transpo:** D749XHD

APPLICATION / APLICACIÓN:

CHEVROLET: Malibu V6 3.1L;

OLDSMOBILE: Cutlass V6 3.1L

ALTERNATOR / ALTERNATOR:

DELCO: 10464414, 10480317; **LESTER:** 8249; **PIC:** 2406122

RECTIFIER:

GA1758

DELCO
GA712

FEATURES / CARACTERÍSTICAS: 'B' Circuit, RVC SYSTEM

REPLACES / REEMPLAZA:

GM: 13582947, 222725, LRC25D

APPLICATION / APLICACIÓN:

GM: S10 Flex 2012>, S10 Diesel 2013>, Sonic 2012>, Cruze 2012>, Tracker 2013>, Trail Blazer 2014>

ALTERNATOR / ALTERNATOR:

GM: 13579666, 13579677, 13579661

RECTIFIER:

GA1755 / GA1757

DELCO
GA713

FEATURES / CARACTERÍSTICAS: 14V, 'B' Circuit

REPLACES / REEMPLAZA:

Delco: 10514474, 10526697

APPLICATION / APLICACIÓN:

MACK: Series CH, CL, CT/CTP, CV, CX, DM/DMM, FDM, Granite, MR, RB, RD 99>08;

VOLVO: Series VHD, VNM 01>07

ALTERNATOR / ALTERNATOR:

DELCO: 8600009, 8600018, 86000019, 86000032, 86000068, 86000096, 86000100, 86000102, 86000142, 86000143, 86000151, 86000152, 86000153, 86000154, 86000165, 86000166, 86000167, 86000168, 86000403, 86000900, 86000901, 86000902, 86000903

DELCO
GA714

FEATURES / CARACTERÍSTICAS: 28V, "B" Circuit, B+, D-, DF, W, P, L, IG and S

REPLACES / REEMPLAZA:

DELCO: 10521828, 10526698; **WAI/Transpo:** 13708D, D4476; **AS Poland:** ARE1024

APPLICATION / APLICACIÓN:

CATERPILLAR: Wheel Loader 924H, 938H

ALTERNATOR / ALTERNATOR:

DELCO: 8600016, 8600017, 8600020, 8600154, 8600360

DELCO
GA715

FEATURES / CARACTERÍSTICAS: 14V, 'B' Circuit, B+, D-, DF, W, L

REPLACES / REEMPLAZA:

-

APPLICATION / APLICACIÓN:

Chevrolet: Opra 20L 2004-2008; **Suzuki:** Forenza 20L 2001-2008, Suzuki Reno 20L 2005-2008; **GM:** Aveo (con estactor ativo)

ALTERNATOR / ALTERNATOR:

Delco: 96408588; **GM:** 96540542, 96838439, 96954113; **Suzuki:** 31400-85Z00, 31400-85Z01, 31400-85Z02

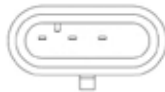
DELCO
GA716

FEATURES / CARACTERÍSTICAS: 14V

REPLACES / REEMPLAZA:

DELCO: 22007; **TRANSPO:** D2262

APPLICATION / APLICACIÓN:

GM: Aveo

ALTERNATOR / ALTERNATOR:

...



DELCO
GA721

FEATURES / CARACTERÍSTICAS: 14V

REPLACES / REEMPLAZA:
Delco: 19009715; **WAI/Transpo:** D9715; **Regitar:** D712; **Cargo:** 232074

APPLICATION / APLICACIÓN:
Acura: CL V6 3.0 1997>1999;

Honda: Accord V6 3.0 1998>1999

ALTERNATOR / ALTERNATOR:
HONDA: 06311P8C505RM, 31100P8AA01, 31100P8AA02, 31100P8CA02, 31100P8CA02RM

DELCO
GA722

FEATURES / CARACTERÍSTICAS: 14V, 'B' Circuit

REPLACES / REEMPLAZA:
Delco: 10458199, 19054622; **Transpo:** D200XHD; **Regitar:** D235SEL; **Cargo:** 232665

APPLICATION / APLICACIÓN:
BUICK TRUCK: Rainier V8 5.3 2006

CADILLAC TRUCK: Escalade EXT V8 6.0 2003>2004

CHEVROLET TRUCK: Avalanche 1500 V8 5.3 2002>2004, Silverado 1500 V6 4.3 2003

CHEVROLET VAN: Express 1500 V6 4.3 2001>2004

GMC TRUCK: Envoy V8 5.3L 2005>2006, Sierra 1500 V6 4.3 2003>2004

ISUZU TRUCK: Ascender V8 5.3 2003>2005

SAAB TRUCK: 9-7x V8 5.3 2005>2006

ALTERNATOR / ALTERNATOR:
DELCO: 10464476, 15754097, 15754097A

DELCO
GA723 // NEW //

FEATURES / CARACTERÍSTICAS: 14V, 'B' Circuit

REPLACES / REEMPLAZA:
Delco: 07C12A0887, 10517755; **Transpo:** D3587; **AS-Poland:** ARE1043; **Mobiletron:** VR-D755

APPLICATION / APLICACIÓN:
CHEVROLET: Avalanche V8 5.3 2007>2010, Avalanche V8 6.0 2007>2009, Colorado V8 5.3 2009, Silverado 1500 V6 4.3 2007>2010, Silverado 1500 V8 4.8/5.3/6.0/6.2 2007>2010, Silverado 2500 V8 6.0 2010;

GMC: Canyon V8 5.3L 2009>2010, Sierra V8 5.3L 2007>2010, Sierra V8 6.2L 2008>2010, Yukon V8 4.8L 2007>2009, Yukon V8 5.3L 2008>2010;

HUMMER TRUCK: H3 V8 5.3L 2008>2009

ALTERNATOR / ALTERNATOR:
CHEVROLET: 10392759, 15093928, 15093929, 15225928, 15263858, 15857608, 15857609, 15905871, 15905872, 15905874, 20881337, 20989651, 25869451, 25877026; **DELCO:** 10392759, 15093928, 15093929, 15200268, 15225928, 15263858, 15857608, 15857609, 15905871, 15905872, 20989651, 25869451, 25877026, 8400078, 8400105, 8400226, 8400240; **ISUZU:** 8152259280; **SAAB:** 15-22-5928

DELCO
GA726 // NEW //

FEATURES / CARACTERÍSTICAS: 14V, 'A' Circuit

REPLACES / REEMPLAZA:
Cargo: 235844; **AS-Poland:** ARE1041; **Transpo:** D2206; **Mobiletron:** VR-D717; **Era:** 216093

APPLICATION / APLICACIÓN:
CHEVROLET: Aveo L4 1.6 2004>2008, Lacetti 1.4 16V 2005, Lacetti estate 1.6 2005>2011, Lacetti saloon 1.4/1.6 2005>2013, Nubira estate 1.6/1.8 2005, Nubira saloon 1.4/1.6/1.8 2005;

SUZUKI: Swift+ L4 1.6 2004>2008

ALTERNATOR / ALTERNATOR:
CHEVROLET: 96540542, 96838439, 96954113;

SUZUKI: 31400-85Z00, 31400-85Z01, 31400-85Z02

DELCO
GA937

FEATURES / CARACTERÍSTICAS: 28V, 'B' Circuit

REPLACES / REEMPLAZA:
Delco: 19020406; **Mobiletron:** VR-D406B

APPLICATION / APLICACIÓN:
VOLKSWAGEN: Bus Queops Evolution (18320 EOT) with engine Cummins ISC 8,3L Diesel

ALTERNATOR / ALTERNATOR:
DELCO: 8600054, 8600534; **VW:** 2Z0903015C

RECTIFIER:

GA1794

DELCO
GA941

FEATURES / CARACTERÍSTICAS: 'B' Circuit, RVC SYSTEM

REPLACES / REEMPLAZA:

Delco: 94753743

APPLICATION / APLICACIÓN:

GM: Onix, Cobalt, Spin, Cruze 2013>

ALTERNATOR / ALTERNATOR:

DELCO: 94751298, 94751297, 94767674

RECTIFIER:

GA1756

DELCO
GA942

FEATURES / CARACTERÍSTICAS: 14V, 'A' Circuit

REPLACES / REEMPLAZA:

Delco: 271850; **WAI/Transpo:** D850

APPLICATION / APLICACIÓN:

OTHERS: Marítima REG 5SI

ALTERNATOR / ALTERNATOR:

DELCO: 19020704, 19020707;

MERCURY: 875286AA, 875286T, 881247A1, 889956

DELCO
GA943

FEATURES / CARACTERÍSTICAS: 28V, 'A' Circuit, Terminals P, L, IG, S.

REPLACES / REEMPLAZA:

-

APPLICATION / APLICACIÓN:

CUMMINS: Equipaments with Cummins motors

ALTERNATOR / ALTERNATOR:

DELCO: 8600365

DELCO
GA944

FEATURES / CARACTERÍSTICAS: 14V, 'A' Circuit, Terminals P, L, IG, S.

REPLACES / CARACTERÍSTICAS:

Delco: 220198

APPLICATION / APLICACIÓN:

CUMMINS: 11 SI 70-95 Amperes;

CATERPILLAR: Tractors

ALTERNATOR / ALTERNATOR:

DELCO: 19020204, 19020207, 19020208; **CUMMINS:** 3972730; **CASE:** 87038475

DELCO
GA945

FEATURES / CARACTERÍSTICAS: 14V, 'A' Circuit

REPLACES / REEMPLAZA:

Delco: 271840; **WAI/Transpo:** D840

APPLICATION / APLICACIÓN:

OTHERS: Marítima REG 5SI

ALTERNATOR:

DELCO: 19020703, 19020706;

MERCURY: 857006T, 875285T1, 881248T, 889955, 889955A03

DELCO
GA947

FEATURES / CARACTERÍSTICAS: 14V, 'A' Circuit

REPLACES / REEMPLAZA:

Daewoo: 271710, 271940; **Cargo:** 233975; **Transpo:** D940; **Mobiletron:** VR-D740; **Regitar:** D740

APPLICATION / APLICACIÓN:

Mercuriser Engine - Marine: Model 350,454 Mag MPI;

Mercuriser Stern Drive: Model MX 6.2L

ALTERNATOR:

DELCO: 19020601, 19020604, 19020608, 19020609, 19020612, 19020614, 19020615

DELCO
GA948

FEATURES / CARACTERÍSTICAS: 28V, 'B' Circuit

REPLACES / REEMPLAZA:

Delco: 10514591, 10535656

APPLICATION / APLICACIÓN:

MERCEDES BENZ: Actros 1996>2004, Econic, Axor, Axor 2, Atego, Atego 2

ALTERNATOR:

DELCO REMY: 18SI, 19070007, 19070008, 19070009, 19070013, 19070014, 19070015, 19070016, 19070019, 19070021, 19070022

RECTIFIER:

GA1948

DELPHI
GA717

FEATURES / CARACTERÍSTICAS: 14V, 'A' Circuit

REPLACES / REEMPLAZA:

-

APPLICATION / APLICACIÓN:

SSANGYOUNG: Kiron 2.7 diesel - Actyon 2.0 Diesel

ALTERNATOR / ALTERNATOR:

Delphi: A 664 154 0102; **Ssangyong:** A 664 154 0102

RECTIFIER:

GA1402

FD
GA113

FEATURES / CARACTERÍSTICAS: 14V

REPLACES / REEMPLAZA:

FD: DNC12-2; **TOYOTA:** 27700-22010, 30010, 31010, 40025; **NEW ERA:** AVR-551

APPLICATION / APLICACIÓN:

TOYOTA: Corolla 3RC, 8RC, 18RC, Corona MKII, Stout, Hilux, Corolla 1100/ 1200/ 1600, Celica, Carina 65>75

ALTERNATOR:

-

FORD
GA811

FEATURES / CARACTERÍSTICAS: 14V 'A' Circuit

REPLACES / REEMPLAZA:

Ford: E43F-10316-AA, E43Z-10316-B, E63F-10316-AA, E63F-10316-BB; **Motorcraft:** GR-784, GR-784B; **Regitar:** GR784M; **Cargo:** 131907; **WAI/Transpo:** F784

APPLICATION / APLICACIÓN:

FORD: Mustang, Taurus, Mercury Sable 3.0L, 3.8L.

ALTERNATOR / ALTERNATOR:

FORD: FD3U-10300-CA, F4DU-10300-CA, F4DU-10300-DA, G1310.

RECTIFIER:

GA1202

FORD
GA812

FEATURES / CARACTERÍSTICAS: 14V 'A' Circuit

REPLACES / REEMPLAZA:

Ford: F3AU-10316-AA, F3AZ10316A, F3AZ10346A, F3RU10316AA; **Regitar:** GR811B; **Cargo:** 135854; **WAI/Transpo:** F785

APPLICATION / APLICACIÓN:

FORD: Mondeo 1.8, Crown, Victoria w / Police option, Lincoln Town Car

ALTERNATOR / ALTERNATOR:

FORD: F3AU10300CA, F5AU10300AA, F6PU10300AA, F6PU10300AAA

RECTIFIER:

GA1202

FORD
GA813

FEATURES / CARACTERÍSTICAS: 14V 'A' Circuit

REPLACES / REEMPLAZA:

Ford: F50U100359AA, F50Y-10316-A, F50Y-10316-A; **Regitar:** GR815; **Cargo:** 138663; **WAI/Transpo:** F796

APPLICATION / APLICACIÓN:

FORD: Lincoln Continental

ALTERNATOR / ALTERNATOR:

FORD: F50U10300FC, F5DU10300DB, F50U10300FA, F50U10300GS, F50Y10346A, F60U10300AA, F60U10300AB, F60Y10346AA, F68U10300AD, F68U10300AF, F68U10300AS, F68Z10346AD, F6DU10300BB, F6DU10300BD, F6DU10300DB, F6DU10300DC, F6DU10300DD, F6DZ10346B, F6DZ10346BRM, F6DZ10346D, F6DZ10346DRM, F6OU10300AA, F6OY10346AA, F78U10300AA, F78Z10346AA, F78Z10346AARM, F80U10300CA, F80U10300CB, F8OZ10346CA, F8OZ10346CA, XW7U10300AA, XW7U10300AD, XW7Z10346AA, XW7Z10346AARM, YF1Z10346E; **LESTER:** 7773, 7780, 7786; **MOTORCRAFT:** GL354, GL355, GL383, GL384, GL406, GL434, **PIC:** 250246, 250246A, 250270, 250270A, 250275

RECTIFIER:

GA1203

FORD
GA814

FEATURES / CARACTERÍSTICAS: 14V, 'A' Circuit, Terminals: I, D, A

REPLACES / REEMPLAZA:

Ford: F6DU-10C359-AA, F6DY-10316-A; **Regitar:** GR817; **Cargo:** 230066; **WAI/Transpo:** F798

APPLICATION / APLICACIÓN:

FORD: Lincoln Continental

ALTERNATOR / ALTERNATOR:

FORD: 1L2U-10300-AA, 1L2U-10300-AB, 1L2Z-10346-AB, F6LU-10300-CA, F6LU-10300-CC, F6LU-10300-CD, F6LY-10346-A, F6ZU-10300-BB, F6ZU-10300-BC, F6ZU-10300-BE, F6ZU-10300-BG, F6ZZ-10346-B, F77U-10300-AB, F77U-10300-AC, F77Z-10346-AB, GL-357, GL-363, GL-423, GL433, GL-454, GL-613, XL2U-10300-AA, XL2Z-10346-AA, XL3U-10300-AA, XL3U-10300-AB, XL3Z-10346-AA

RECTIFIER:

GA1203

FORD
GA839

FEATURES / CARACTERÍSTICAS: 14V, 'A' Circuit, Terminals: FR, SIG, A

REPLACES / REEMPLAZA:

Ford: VPF1U-10C359AA, VP4L3U-10C359AA, XW4U-10C359AB; **Cargo:** 233232;

APPLICATION / APLICACIÓN:

MAZDA: TRIBUTE;

FORD: LINCOLN, SCAPE 3.0 V6 2001, WINDSTAR, WITH ALTERNADOR MOTORCRAFT 12V. 105A. F601, XW4U-10C359-AB, SEÑALES AS - RC - L

ALTERNATOR / ALTERNATOR:

FORD: XF2U-10300BC, XW4U-10300CE, 1L8Z-10346AB, XF2Z-10346BA, XW4Z-10346CC, 98AB-10300FC, XR8Z-10346AA, XF2U-10300AB, XW4U-10300CD, 1L8U-10300AC, XF2Z-10346AARM, XW4Z-10346BARM, 98AB-10300EB, XR8U-10300CE, GL462, XW4U-10300CC, 1L8U-10300AB, XF2Z-10346AA, XW4Z-10346BA, 3W1Z-10346BARM, XR8U-10300AF, GL456, XW4U-10300BA, XF2Z-10346AA, XW4Z-10346AARM, 3W1U-10300BB, XR8U-10300AE, 98AZ-10346FA, XW4U-10300AA, XF2U-10300BD, XW4Z-10346AA, 1S41-10300BB, XF2Z-10346BARM, XW4Z-10346CCRM, 98AZ-10346EA, XR8Z-10346CE;

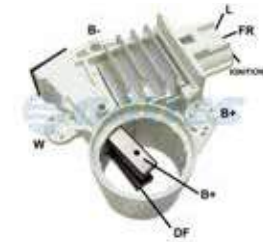
FORD
GA846

FEATURES / CARACTERÍSTICAS: 14V, 'A' Circuit, Terminals: I, FR, A

REPLACES / REEMPLAZA:

Ford: XR2U-10C359-AB, XS7U-10C359-AC; **Regitar:** GR920; **Cargo:** 233233; **WAI/Transpo:** F602; **Mobiletron:** VR-F920

APPLICATION / APLICACIÓN:

FORD: F250 2008>, CONTOUR, MERCURY, COUGAR, MYSTIQUE, WITH ALTERNADOR MOTORCRAFT SERIE 6G 12V.

ALTERNATOR / ALTERNATOR:

Ford 6G Series IR/IF Alternators

FORD
GA847

FEATURES / CARACTERÍSTICAS: 14V, 'A' Circuit, Terminals: I, D, A

REPLACES / REEMPLAZA:

Ford: F8WU-10C359AB; **Cargo:** 230065; **Regitar:** GR900; **WAI/Transpo:** F600

APPLICATION / APLICACIÓN:

FORD: CROWN VICTORIA, MUSTANG V6, LINCOLN, MERCURY, WITH ALTERNADOR MOTORCRAFT 12V F600, F8WU-10C359-AB, SEÑALES I - D - A REGULADOR

ALTERNATOR / ALTERNATOR:

FORD: F81U-10300EB, F81Z-10346EA, XR3U-10300AA, F81U-10300DC, F81Z-10346DA, F81U-10300DB, F81Z-10346CA, F81U-10300CC, F81Z-10346BA, F81U-10300BC, F81U-10300GA, F81Z-10346GA, XR3Z-10346AA;

FORD
GA892

FEATURES / CARACTERÍSTICAS: 14V 'A' Circuit, brush holder assembly.

REPLACES / REEMPLAZA:

Ford: F3AU-10316-AA, F3AZ10316A, F3AZ10346A, F3RU10316AA; **Regitar:** GR811B; **Cargo:** 135854; **WAI/Transpo:** F785

APPLICATION / APLICACIÓN:

FORD: Crown Victoria 4.6 V8 93>95, Mondeo 1.8;

LINCOLN: Town Car 4.6 V8 93>95

ALTERNATOR / ALTERNATOR:

FORD: F3AU10300CA, F5AU10300AA, F6PU10300AA, F6PU10300AAA

RECTIFIER:

GA1202

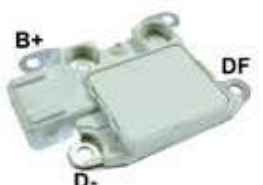
FORD
GA995 // NEW //

FEATURES / CARACTERÍSTICAS: 14V 'A' Circuit

REPLACES / REEMPLAZA:

Mobiletron: VR-F818; **AS-Poland:** ARE9010; **Cargo:** 138185; **Transpo:** F786

APPLICATION / APLICACIÓN:

FORD: Contour L4 2.0 1989>1995, Cougar 2500 V6 1998>2002, Mondeo I 2500, V6 Duratec 1993>2000, Mondeo estate 2.5 1995>1996, Mondeo II saloon 2.5 24V 2000;

MERCURY: Mystique L4 2.0 1989>1995, Cougar V6 2.5 2450 1999

ALTERNATOR / ALTERNATOR:

FORD: 94BB-10300AE, F4PU-10300AA, F5RU-10300BA, F6AZ-10300A

GAUSS

GA015



FEATURES / CARACTERÍSTICAS: 28-42V, 'B' Circuit - Potentiometer to adjust the voltage

REPLACES / REEMPLAZA:

APPLICATION / APLICACIÓN:

For railway purposes. For applications in general

ALTERNATOR / ALTERNATOR:

HITACHI

GA217 // NEW //



FEATURES / CARACTERÍSTICAS: 28V, 'A' Circuit

REPLACES / REEMPLAZA:

Cargo: 234701; **AS-Poland:** ARE2035

APPLICATION / APLICACIÓN:

NISSAN: Patrol 3.3 D 1985>1990, Patrol 3.2 D 1985>1989

ALTERNATOR / ALTERNATOR:

HITACHI: LR235402, LR235403E, LR235403S, LR235403T, LR235404C, LR235404S, LR235404T, LR235405, LR235405S, LR235405T;

NISSAN: 2310003T06, 2310010T09, 2310011T18, 23100C8604

HITACHI

GA221 // NEW //



FEATURES / CARACTERÍSTICAS: 14V, 'A' Circuit

REPLACES / REEMPLAZA:

Mobiletron: VR-H2000-64; **Regitar:** VRH2000-64; **AS-Poland:** ARE2032; **Cargo:** 238691; **Transpo:** IH669

APPLICATION / APLICACIÓN:

OPEL: Astra H 1700 2004>2007, Corsa D 1700 16V 2006>2010, Corsa/Combo II 1700 6V 2004>2010

ALTERNATOR / ALTERNATOR:

HITACHI: LR1110-502, LR1110-503, LR1110-503B, LR1110-503C, LR1110-503E, LR1110-503F;

CHEVROLET: 97363832;

ISUZU: 8973638320, 8973638321, 8973638322, 8973638330, 8973695081, 8980564390;

OPEL: 6204252, 897369-5080, 93189496;

VAUXHALL: R1530090, R1530091

HITACHI

GA241



FEATURES / CARACTERÍSTICAS: 14V, 'A' Circuit, Terminals: S, L

REPLACES / REEMPLAZA:

Hitachi: L1805340, L1808315; **Nissan:** 2321564J01; **Regitar:** VRH2000-18; **WAI/Transpo:** IH762

APPLICATION / APLICACIÓN:

NISSAN: PATHFINDER WITH HITACHI 12V ALTERNATOR

ALTERNATOR / ALTERNATOR:

HITACHI: LR1100704B, LR160723, LR170734, LR170734B, LR170739, LR180725, LR180725A, LR180725C, LR180725D;

NISSAN: 23100-64J01;

HITACHI

GA242



FEATURES / CARACTERÍSTICAS: 14V, 'A' Circuit, Terminals: S, L

REPLACES / REEMPLAZA:

Hitachi: L1805340, L1808315; **Nissan:** 2321564J01;

APPLICATION / APLICACIÓN:

NISSAN: PATHFINDER 3.0, STANZA 2.4, SENTRA 2.0, WITH HITACHI 12V ALTERNATOR

ALTERNATOR / ALTERNATOR:

HITACHI: LR160724, LR160727, LR170739B, LR170740, LR170740B, LR170741, LR180733B, LR180734B, LR180734C, LR180736B, LR180737, LR180737B, LR180737C, LR190716B, LR190717B, LR190718, LR190719, LR190720; **NISSAN:** 23100-64J00, 23100-80G08, 23100-12G02;

HITACHI

GA243



FEATURES / CARACTERÍSTICAS: 14V, 'A' Circuit, Terminals: S, L

REPLACES / REEMPLAZA:

Hitachi: 23133F6100, GD310547B, L1803315, L1807315; **Nissan:** 2313316E05, 2313326E60, 23133-F6100; **Cargo:** 132990; **Huco:** 132953

APPLICATION / APLICACIÓN:

NISSAN: MAXIMA WITH HITACHI 12V ALTERNATOR

ALTERNATOR / ALTERNATOR:

HITACHI: LR170-721, LR170-713, LR170-704, LR190-709, LR190-704, LR180-704;

HITACHI
GA244

FEATURES / CARACTERÍSTICAS: 14V 'A' Circuit, Terminals: S, L

REPLACES / REEMPLAZA:

Hitachi: L1100G8340, L1110G53402; **Nissan:** 23215-0L701; **Regitar:** VRH2000-46; **WAI/Transpo:** IH774; **AS Poland:** ARE2019

APPLICATION / APLICACIÓN:

NISSAN: MAXIMA 3.0 1995-97, INFINITIY 98 -01, WITH HITACHI 12V ALTERNATOR

ALTERNATOR / ALTERNATOR:

HITACHI: LR1110-707G, LR1100-711B, LR1110-709B;

HITACHI
GA245

FEATURES / CARACTERÍSTICAS: 14V 'A' Circuit, Terminals: S, L

REPLACES / REEMPLAZA:

Fiat/Marelli: 940038070; **Hitachi:** 2313358S00, 2313358S01, 23133D4400, L16043154, L17013151, L17053151, L1708315; **Nissan:** 2313358S00, 2313358S01, 23133D4400, 23133D4401; **Regitar:** VRH2000-5H; **WAI/Transpo:** IH242; **AS Poland:** ARE2012

APPLICATION / APLICACIÓN:

NISSAN: V16, 200SX, 240X, SUNNY, PULSAR, SENTRA, WITH HITACHI 12V ALTERNATOR

ALTERNATOR / ALTERNATOR:

HITACHI: LR160715, LR170714, LR170715, LR170715B, LR170716, LR170716B, LR170717, LR170719, LR180711B, LR180711E, LR180712, LR180712B, LR180714, LR180714B, LR180715, LR180716, LR180716B, LR180718, LR180718B, LR180719;

HITACHI
GA246

FEATURES / CARACTERÍSTICAS: 14V 'A' Circuit

REPLACES / REEMPLAZA:

Hitachi: 23133D0200, 23133Q4601, 23133W1601, 23133W1606, 23133W7101, L15043151, L15063151, L15073301, LR15043151, Q4601, W1606, W7101; **Regitar:** VRH2000-37; **Cargo:** 130832; **WAI/Transpo:** IH203

APPLICATION / APLICACIÓN:

NISSAN

ALTERNATOR / ALTERNATOR:

HITACHI: LR150101B, LR150125B, LR150132B, LR15098E, LR15099B, LR160105, LR160109C, LR160130, LR16085B, LR17010

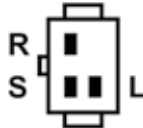
HITACHI
GA247

FEATURES / CARACTERÍSTICAS: 14V 'A' Circuit, S-IG-L Terminals

REPLACES / REEMPLAZA:

WAI/Transpo: IH204

APPLICATION / APLICACIÓN:

LUV L4 2.2 82-81; **ISUZU:** L4 2.2 81

ALTERNATOR / ALTERNATOR:

HITACHI: LR15078B; **ISUZU:** 8942214501

GM: 94246956, 94246957

HITACHI
GA248

FEATURES / CARACTERÍSTICAS: 14V 'A' Circuit

REPLACES / REEMPLAZA:

Hitachi: 2352805E06, 2352818G01, L15063601, L15093155, L16023153, L16063153; **Magneti Marelli:** 940 038 069; **Cargo:** 133543, 137189; **Regitar:** VRH2000-30; **Cargo:** 137189; **WAI/Transpo:** IH205; **AS Poland:** ARE2001

APPLICATION / APLICACIÓN:

FORD: Maverick 2.7TD;

NISSAN: Patrol, Terrano, Vanette Bus, Urvan, Bluebird

ALTERNATOR / ALTERNATOR:

HITACHI: LR140415B, LR140419, LR140419T, LR140421, LR140421T, LR140422, LR140422T, LR140436, LR140436S, LR150425, LR150425B, LR150428, LR150428S, LR150428T, LR150430m, LR150430S, LR150435S, LR150443S, LR160414, LR160417, LR160421C, LR160421E, LR160421F, LR160422B, LR160426S, LR160426T, LR160427S, LR160436S, LR160436T, LR160437S, LR160437T, LR170405, LR170406B, LR170406C, LR170406E, LR170406F, LR170406T, LR170407S, LR170407T, LR170408S, LR170408T, LR170412S, LR170412T, LR170413, LR170414B, LR170414C, LR170414E, LR170417B, LRT150430T

HITACHI
GA249

FEATURES / CARACTERÍSTICAS: 14V 'A' Circuit

REPLACES / REEMPLAZA:

Hitachi: FA8065A, L170-G1315; **Regitar:** VRH2000-40, VRH2000-47; **Cargo:** 137841; **WAI/Transpo:** IH254, IH254V; **AS Poland:** ARE2006

APPLICATION / APLICACIÓN:

OPEL: Astra 1.7, Corsa 1.5, Vectra A 1.7td, Corsavan 1.7, Cavalier Mk

ALTERNATOR / ALTERNATOR:

HITACHI: LR160412B, LR170420, LR170420B

HITACHI

GA250

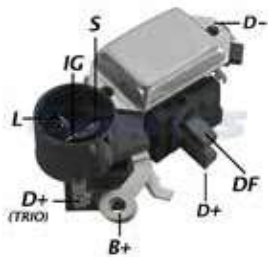

FEATURES / CARACTERÍSTICAS: 14V 'A' Circuit

REPLACES / REEMPLAZA:

Hitachi: 8941674100, 8970260520, L15033155, L160G1315; **Regitar:** VRH2000-29; **Cargo:** 133544; **WAI/Transpo:** IH252; **AS Poland:** ARE2004

APPLICATION / APLICACIÓN:

ISUZU: Trooper 2.8 TD, Midi 2.0, 2.2;
OPEL: Campo 2.5/ 3.1, Monterey 3.1TD

ALTERNATOR / ALTERNATOR:

HITACHI: LR150-431, LR150-432, LR150-439, LR150-439B, LR170-401, LR170-410, R170-410B, LR170-418, LR170-418C

HITACHI

GA251

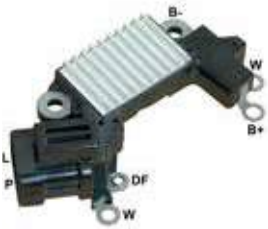

FEATURES / CARACTERÍSTICAS: 14V 'A' Circuit

REPLACES / REEMPLAZA:

Hitachi: L170G-3319, L170G-6308, L170G-7315, LR170G-7315; **Regitar:** VRH2000-41; **Cargo:** 139980; **WAI/Transpo:** IH776; **AS Poland:** ARE2009; **Mobiletron:** VR-H200041

APPLICATION / APLICACIÓN:

OPEL: Astra Mk3 1.7 96>98, Corsa B 1.5/1.7 96>00, Corsa B Box 99>00, Vectra B 1.7 95>96, Astra Van 1.7 96>98, Corsa/Combo 1.7 96>01; **Vauxhall:** Vectra B/Vectra B Hatchback 95>96

ALTERNATOR / ALTERNATOR:

HITACHI: L170G3319, L170G6308, LR170G7315, LR170-505, LR170-505B

HITACHI

GA252



FEATURES / CARACTERÍSTICAS: 14V 'A' Circuit

REPLACES / REEMPLAZA:

Hitachi: L180G2340, L180G6340, L165G2315, 2321585L00; **Regitar:** VRH2000-16; **Cargo:** 135021; **WAI/Transpo:** IH761; **AS Poland:** ARE2015

APPLICATION / APLICACIÓN:

NISSAN: Primera 1.6 stationcar 90-94, Sunny 1.4i 90-95, Sunny 1.4i Stationcar 90-95, Sunny 1.6i

ALTERNATOR / ALTERNATOR:

HITACHI: LR165-708C, LR170-738C, LR170-744, LR180-731B

RECTIFIER:

GA1760

HITACHI

GA253



FEATURES / CARACTERÍSTICAS: 14V 'A' Circuit

REPLACES / REEMPLAZA:

Hitachi: L170-33152, LR170-33152; **Regitar:** VRH2000-14; **Cargo:** 135027; **WAI/Transpo:** IH760; **AS Poland:** ARE2014

APPLICATION / APLICACIÓN:

NISSAN: 100NX 1.6, Primera 1.6 stationcar, Sunny 1.4i, Sunny 1.6i stationcar, Pulsar, Sentra

ALTERNATOR / ALTERNATOR:

HITACHI: LR170-738, LR170-738B

RECTIFIER:

GA1768

HITACHI

GA254



FEATURES / CARACTERÍSTICAS: 14V 'A' Circuit

REPLACES / REEMPLAZA:

Hitachi: L190 G33 401; **Regitar:** VRH2000-44; **Mobiletron:** VR-H2000-44; **Cargo:** 234314, 235659, 234612; **WAI/Transpo:** IH738; **AS Poland:** ARE2025

APPLICATION / APLICACIÓN:

NISSAN: 1998-02, Nissan Frontier 2.4L 1999-01, Nissan Frontier 3.3L 2000-02, Nissan Xterra 2.4L 2000-01, Nissan Xterra 3.3L

ALTERNATOR / ALTERNATOR:

HITACHI: LR1100-709, LR1100-709B, LR170-757B

HITACHI

GA255



FEATURES / CARACTERÍSTICAS: 14V 'A' Circuit

REPLACES / REEMPLAZA:

Hitachi: 50R 004 244-001; **Regitar:** VRH2000-50; **Cargo:** 232443; **WAI/Transpo:** IH769; **Mobiletron:** VRH200050; **AS Poland:** ARE2008

APPLICATION / APLICACIÓN:

Opel: 1999> Astra, Vectra 1.7L 1999>, Corsa 1.7L with A/C

ALTERNATOR / ALTERNATOR:

HITACHI: LR1100502E, LR1100502F, LR170509E

HITACHI
GA256

FEATURES / CARACTERÍSTICAS: 14V 'A' Circuit

REPLACES / REEMPLAZA:
Hitachi: L185G2340, **Subaru:** 23815-AA050; **Regitar:** VRH2000-27, VRH2000-52; **Cargo:** 235144; **WAI/Transpo:** IH765; **Mobiletron:** VR-H2000-27

APPLICATION / APLICACIÓN:
NISSAN: 240SX 2.4 95>98;

SUBARU: Legacy 2.2/2.5 95>98

ALTERNATOR / ALTERNATOR:
HITACHI: LR180-742, LR185-701, LR185-701H, LR185-702, LR190-724, **SUBARU:** 23700-AA210, 23700-AA210F, 23700-AA211, 23700-AA211F, 23700-AA34A

HITACHI
GA257

FEATURES / CARACTERÍSTICAS: 14V 'A' Circuit

REPLACES / REEMPLAZA:
Hitachi: L1100G3340, L1100G53402, L1100G8340, L1110G9340; **Regitar:** VRH2000-28; **Cargo:** 138717; **WAI/Transpo:** IH766; **AS-Poland:** ARE2011

APPLICATION / APLICACIÓN:
NISSAN: Maxima V6 3.0L, QX V6 2.0/ 3.0L, Murano V6 3.5L;

INFINITI: i30 V6 3.0L, Q45 V8 4.1L

ALTERNATOR / ALTERNATOR:
HITACHI: LR1110-705, LR1110-705B, LR1110-707, LR1110-707E, LR1125-702, LR1125-702B; **NISSAN:** 23100-31U01, 23100-31U02, 23100-40U00, 23100-6P000, 23100-6P005

HITACHI
GA258

FEATURES / CARACTERÍSTICAS: 14V 'A' Circuit

REPLACES / REEMPLAZA:
Hitachi: J134, L170G6315, L180G23401; **Nissan:** 22020-85M10, 23215-0M000, 23215-0M800, 23215-0M801, 23215-0M810; **Regitar:** VRH2000-38; **Cargo:** 138727; **WAI/Transpo:** IH767; **AS Poland:** ARE2071

APPLICATION / APLICACIÓN:
NISSAN: Altima, 200SX, Pickup

ALTERNATOR / ALTERNATOR:
HITACHI: LR160-727, LR170-745, LR170-748, LR170-748B, LR180-741, LR180-741H, LR180-741S, LR180-744; **NISSAN:** 23100-0M003, 23100-0M005, 23100-0S200, 23100-0S300, 23100-1E800, 23100-4B400

HITACHI
GA259

FEATURES / CARACTERÍSTICAS: 14V 'A' Circuit

REPLACES / REEMPLAZA:
Hitachi: L185G-2340; **Subaru:** 23815-AA050; **Regitar:** VRH2000-27, VRH2000-52; **Cargo:** 234311; **WAI/Transpo:** IH768; **Mobiletron:** VR-H2000-52

APPLICATION / APLICACIÓN:
SUBARU: Forester 2.0, Impreza 1.6, 1.8, Impreza 2.0 GT Turbo, Legacy 2.0, 2.2;

KIA: Sephia 1.8L, Spectra 1.8L, Sportage 2.0L

ALTERNATOR / ALTERNATOR:
KIA: OK012-18-300, OK241-18-300

HITACHI
GA260

FEATURES / CARACTERÍSTICAS: 14V, 'A' Circuit, Terminals: S, L

REPLACES / REEMPLAZA:
Mobiletron: VR-H2000-62; **Regitar:** VRH2000-62; **Transpo:** IH744

APPLICATION / APLICACIÓN:
SUBARU: LEGACY;

IZUSU: RODEO 3.2 1998>2000;

SAMSUNG;
NISSAN: WITH HITACHI 12V ALTERNATOR

ALTERNATOR / ALTERNATOR:
HITACHI: LR190-744; **ISUZU:** 89720-43320, 29027-68300;

HITACHI
GA262

FEATURES / CARACTERÍSTICAS: 14V, 'A' Circuit, Terminals: S, D, IG, L

REPLACES / REEMPLAZA:
Hitachi: GD211509A, L170-23152; **Subaru:** 23815-AA010; **Cargo:** 135024;

APPLICATION / APLICACIÓN:
SUBARU: Legacy H4 2.2L, Legacy 1.8/ 2.0/ 2.2L

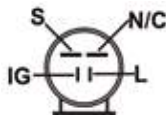
ALTERNATOR / ALTERNATOR:
HITACHI: LR170-732C, LR170-732B; **SUBARU:** 23700-AA090;

HITACHI
GA263

FEATURES / CARACTERÍSTICAS: 14V, 'A' Circuit

REPLACES / REEMPLAZA:

Hitachi: 01E18Z

APPLICATION / APLICACIÓN:

ASIA MOTORS: Towner, Effa, Hafei, Chana

ALTERNATOR / ALTERNATOR:

Hitachi: 1105 02312 498

RECTIFIER:

GA1763

HITACHI
GA285 // NEW //

FEATURES / CARACTERÍSTICAS:

REPLACES / REEMPLAZA:

Transpo: IH785; **Mobiletron:** VR-H2000-94B

APPLICATION / APLICACIÓN:

ISUZU: NRP 4HF1,4HG1, 4HJ1 1998

ALTERNATOR / ALTERNATOR:

HITACHI: LR250-511B

ISUZU: 8-97186-551-1

HITACHI
GA830

FEATURES / CARACTERÍSTICAS: 14V 'A' Circuit, Terminals BSRLF

REPLACES / REEMPLAZA:

Hitachi: TR1Z-43, TR1Z-53, TR1Z-62, TR1Z-64; **Nissan:** 23125-W1700, 23125-W1701; **Regitar:** VRH2000-3; **Cargo:** 136284; **WAI/Transpo:** IH212

APPLICATION / APLICACIÓN:

ISUZU: Pick up Diesel;

NISSAN: Maxima Diesel, Sentre, Pick up

ALTERNATOR / ALTERNATOR:

HITACHI: LR140130B, LR140130P, LR140131, LR140131B, LR140138, LR150-55B, LR150-133, LR150-133B; **ISUZU:** 8-94155-308-5, 8-94234-987-2, 8-94234-987-3, 8-94238-453-2, 8-94246-956-0, 8-94246-956-1

HITACHI
GA879

FEATURES / CARACTERÍSTICAS: 14V 'A' Circuit

REPLACES / REEMPLAZA:

Hitachi: TR1Z-28; **Nissan:** 23125-F2500, 23215-B9800, 23215-P2500, 23215-Q4601, 23215-Q4602; **Bosch:** 0 986 192 026;

Lucas: 21511113; **Subaru:** 49575-7101, 49575-7301; **Motorcraft:** EGR255; **Cargo:** 130832; **WAI/Transpo:** IH211

APPLICATION / APLICACIÓN:

NISSAN: Bluebird 1.8, Cherry 1.0, 1.3, 1.5, Patrol 2.8, Prairie 1.8,2.0, Stanza 1.6, 1.8, Sunny 1.5, Terrano 2.4, Vanette 1.5, 2.4i;

SUBARU: 1800 Hatchback, 1800 Limousine 4WD, 1800 Station, 1800 Turismo Hatchback 4WD

ALTERNATOR / ALTERNATOR:

HITACHI: LR135123, LR135130, LR13531, LR13532, LR13541B; LR13561, LR13561B, LR13801, LR150101B, LR150125, LR150140, LR150177, LR150194, LR150194B, LR150197, LR150197B, LR150218, LR15030B, LR16078C, LR16082, LR16082B, LR16084, LR16084B, LR16093, LR17002B, LR17010, LR17014

HITACHI
GA880

FEATURES / CARACTERÍSTICAS: 14V 'A' Circuit, Terminals BSLFE

REPLACES / REEMPLAZA:

Hitachi: TR1Z-27, TR1Z-33, TR1Z-34, TR1Z-47, TR1Z-48, TR1Z-56, TR1Z-65; **Nissan:** 23125-F2500, 23215-B9800, 23215-P2500, 23215-Q4601, 23215-Q4602; **Bosch:** 0 986 192 026; **Lucas:** 21511113; **Motorcraft:** EGR255; **Subaru:** 49575-7101, 49575-7301; **Regitar:** VRH2000-1; **Cargo:** 130834; **WAI/Transpo:** IH210

APPLICATION / APLICACIÓN:

NISSAN: Bluebird 1.8, Cherry 1.0, 1.3, 1.5, Patrol 2.8, Prairie 1.8,2.0, Stanza 1.6, 1.8, Sunny 1.5, Terrano 2.4, Vanette 1.5, 2.4i;

SUBARU: 1800 Hatchback, 1800 Limousine 4WD, 1800 Station, 1800 Turismo Hatchback 4WD

ALTERNATOR / ALTERNATOR:

HITACHI: LR135-44, LR135-61, LR135-61B, LR138-01, LR150-125, LR150-125B, LR150-163, LR150-177, LR150-194, LR150-194B, LR150-197, LR150-197B, LR150-30, LR150-30B, LR150-31, LR150-35, LR150-36, LR150-46, LR150-50, LR150-51, LR150-52, LR150-53, LR150-58, LR150-94B, LR150-98, LR150-98B, LR150-99, LR150-99B, LR155-15, LR155-15B, LR155-15C, LR155-17, LR155-18, LR155-23, LR155-24, LR155-25, LR160-104, LR160-109, LR160-109C, LR160-121, LR160-124, LR160-137, LR160-138, LR160-140, LR160-140B, LR160-151, LR160-151R, LR160-166, LR106-20, LR106-36, LR106-39, LR106-42, LR106-422B, LR106-42B, LR106-46, LR106-47, LR106-57, LR106-61, LR106-62, LR106-74, LR106-75, LR106-78, LR106-78B, LR106-78C, LR106-82, LR106-82B, LR106-84, LR106-84B, LR106-93, LR106-14, LR106-18, LR106-21, LR106-22, LR185-02

HITACHI
GA881

FEATURES / CARACTERÍSTICAS: 14V 'A' Circuit, Terminals RSBFE

REPLACES / REEMPLAZA:

Hitachi: TR1Z-46; **Isuzu:** 8 9422 3 9670; **Regitar:** VRH2000-22; **Cargo:** 131528; **WAI/Transpo:** IH214

APPLICATION / APLICACIÓN:

ISUZU: Diesel

ALTERNATOR / ALTERNATOR:

HITACHI: LR140112; **ISUZU:** 8-94221-4514

HITACHI
GA882

FEATURES / CARACTERÍSTICAS: 14V 'A' Circuit, Terminals RRLDFE

REPLACES / REEMPLAZA:

Hitachi: L13513152, TR1Z-44, TR1Z-49, TR1Z-63; **Regitar:** VRH2000-2; **Cargo:** 132434; **WAI/Transpo:** IH215

APPLICATION / APLICACIÓN:

Mustang Skid Steer Loader: 920 Yanmar, 930 Yanmar, 930A Yanmar, 940A Yanmar

Yanmar Tractor: Various models 3T72HL Engine

ALTERNATOR / ALTERNATOR:

HITACHI: LR120-15, LR120-15C, LR120-23, LR125-34, LR135-105, LR135-116, LR135-126, LR135-127, LR-135-58, LR135-58B, LR135-86, LR135-86C, LC135-86F, LR135-91, LR135-95, LR135-95B, LR150-165, LR155-20, LR155-20B, LR155-29, LR165-01, LR165-01C, LR165-03; **ISUZU:** 1705877200, 5001810100, 5812003381, 5812003410, 5812003411, 5812003470, 5812003580, 8944179240, 8944237560; **NISSAN:** 23100-95004, 23100-95009, 23100-95013

HITACHI
GA883

FEATURES / CARACTERÍSTICAS: 28V, 'A' Circuit, Terminals RRLFE

REPLACES / REEMPLAZA:

Hitachi: tr2z-47; **Nissan:** 23500-99008; **Isuzu:** 5 8125 1 0160; **Cargo:** 135026; **Regitar:** VRH2000-2B; **WAI/Transpo:** IH707

APPLICATION / APLICACIÓN:

ISUZU: Industrial;

NISSAN;

ALTERNATOR / ALTERNATOR:

HITACHI: LR21523, LR21524, LR21550, LR22023, LR22024, LR22584T, LR22585, LR22586B, LR22589, LR23560C, LR23561C, LR23562, LR23565, LR23568, LR23569, LR23572B, LR23576, LR23580, LR24019C, LR24020C, LR24021, LR24022E, LR24025, LR24026, LR24029B, LR24031E, LR24032

HITACHI
GA884

FEATURES / CARACTERÍSTICAS: 28V, 'A' Circuit, Terminals BSRLFE

REPLACES / REEMPLAZA:

Hitachi: TR2Z-37, TR2Z-49; **Regitar:** VRH2000-3A; **Cargo:** 132292; **WAI/Transpo:** IH716

APPLICATION / APLICACIÓN:

ISUZU: Industrial;

NISSAN;

ALTERNATOR / ALTERNATOR:

HITACHI: LR225403, LR225407, LR225408B, LR225408C, LR225408E, LR225409B, LR225410, LR225412, LR225412T, LR225413E, LR225413T, LR225414, LR225414T, LR225415B, LR225418B, LR225418B, LR22565P, LR22567P, LR22568B, LR22580, LR22580B, LR235401, LR235402, LR235403E, LR235403T, LR235404C, LR235404T, LR235405, LR235405T, LR235406, LR23558, LR23570, LR23570B, LR23575C, LR23578, LR24034, LR24035, LR240401, LR240402, LR240403B, LR240404B, LR240404C, LR26018, LR26018B, LR26020B, LR26020C, LR27002B, LR27003B, LR27003C

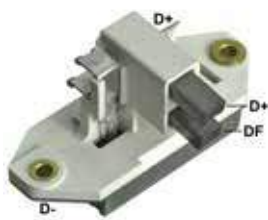
ISKRA
GA401

FEATURES / CARACTERÍSTICAS: 14V, 'A' Circuit

REPLACES / REEMPLAZA:

Iskra: 11 125 019, 11 125 053, 11 125 054, 11 125 056, 11 125 065, 11 125 085, 16 905 323, AER 1401, AER 1406, AER 1505, AER 1506, AER 1510; **Zastava:** 1301670; **Regitar:** VR-IK019; **Cargo:** 131811; **WAI/Transpo:** IK401; **AS Poland:** ARE9007

APPLICATION / APLICACIÓN:

FIAT: 127 1.3L, 131 1.0, Panda 1.3L, Uno 1.3L, Uno 1.4L Dsl Turbo, Fiorino 1.3L

ALTERNATOR / ALTERNATOR:

ISKRA: 11201273, AAK1314; **LESTER:** 13225; **PIC:** 220188, 282100

ISKRA
GA402

FEATURES / CARACTERÍSTICAS: 28V, 'A' Circuit

REPLACES / REEMPLAZA:

Iskra: 11125029, 11125047, 11125087, 16905304, AER1404, AER1504, AER1511; **Regitar:** VR-IK029; **Cargo:** 132857;

WAI/Transpo: IK404; **Magneti Marelli:** RT510149

APPLICATION / APLICACIÓN:

KHD: Tractors

ALTERNATOR / ALTERNATOR:

ISKRA: 11201050, 11201052, 11201066, 11201069, 11201087, 11201098, 11201107, 11201151, 11201162, 11201186, 11201201, 11201360, 11201522, 11201555, 11201557, 11201574, 11201586, 11201633, 11201635, 11201699, 1120170, 3120105, AAK1107, AAK1109, AAK1110, AAK1113, AAK1115, AAK1125, AAK1131, AAK1134, AAK1153, AAK1160, AAK1167, AAK1309, AAK1347, AAK1352, AAK1367, AAK3520, AAK3557, AAK4179, AAK4507, AAK4509, AAK4531, AAK4560

ISKRA
GA403

FEATURES / CARACTERÍSTICAS: 14V, 'A' Circuit

REPLACES / REEMPLAZA:

Iskra: AER1528, 11125122; Regitar: VR-IK149; Cargo: 139513; WAI/Transpo: IK543; AS Poland: ARE9008

APPLICATION / APLICACIÓN:

Fiat: Regata 1.3/ 1.5L, Ritmo 1.1/ 1.5/ 1.6L, Uno 1.5L

Lancia: Delta 1.5L, prisma 1.5L;

MF: Valmet, Lada;

ALTERNATOR / ALTERNATOR:

ISKRA: 11.201.205, 11.201.406

ISKRA
GA404

FEATURES / CARACTERÍSTICAS: 14V, 'A' Circuit

REPLACES / REEMPLAZA:

Iskra: 11 125 263, AER1713

APPLICATION / APLICACIÓN:

VALMET: BM, BH 120A

ALTERNATOR:

-

ISKRA
GA405

FEATURES / CARACTERÍSTICAS: 14V, 'A' Circuit

REPLACES / REEMPLAZA:

Iskra: 11 125 177, AER1560; Cargo: 139515

APPLICATION / APLICACIÓN:

VALMET: MF

ALTERNATOR:

-

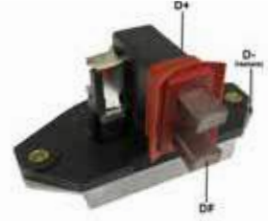
ISKRA
GA406

FEATURES / CARACTERÍSTICAS: 14V, 'A' Circuit

REPLACES / REEMPLAZA:

Iskra: 11.125.343; Letrika: 11.125.343, ARC9060

APPLICATION / APLICACIÓN:

Massey Ferguson: MF290, MF291, MF291K, MF292, MF6360

Valtra: BM, BH

New Holland: TC57, 5090

ALTERNATOR / ALTERNATOR:

Iskra: 11203722, 11203517, 11203972, 11203540, 11203593, 11204311

RECTIFIER:

GA1329

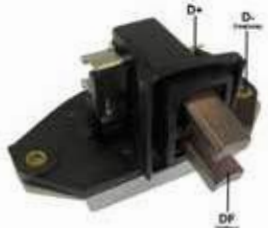
ISKRA
GA407

FEATURES / CARACTERÍSTICAS: 14V, 'A' Circuit

REPLACES / REEMPLAZA:

Iskra: 16915563; Letrika: 16915563; Mahle: MGX 840

APPLICATION / APLICACIÓN:

Massey Ferguson: F200, MF250, MF255, MF262, MF275, MF283, MF290, MF291, MF400, MF415, MF4200, MF425, MF4265, MF4275, MF4283, MF4290, MF4291, MF4292, MF435, MF440, MF445, MF450, MF455, MF460, MF465, MF5300, MF5320, MF5200, MX720, MX750

ALTERNATOR / ALTERNATOR:

Iskra: 11203130, 11203131, 11203634, 11203635; Letrika: 11.203.513, 11.203.270, 11.204.055, 11.204.111, 11.204.112, 11.204.113, 11.204.114, 11.204.124, 11.204.310, 11.204.318, 11.204.365; Mahle: AAK4375, AAK4309, AAK3823, AAK3856, AAK3857, AAK3858, AAK3859, AAK3861, AAK3898, AAK4803, AAK4818

RECTIFIER:

GA1328

ISKRA
GA434

FEATURES / CARACTERÍSTICAS: 14V, 'A' Circuit

REPLACES / REEMPLAZA:

Mobiletron: VR-IK02; **Regitar:** VR-IK02; **As-Poland:** ARE9070; **Cargo:** 231045

APPLICATION / APLICACIÓN:

RENAULT: Ares 540/550 John Deere 3.9 Diesel 1997>2001, Ceres 65 DPSG-3029D Diesel 1993>1995, Ceres 75 John Deere 4039DRT 3.9 Diesel 1994>1998, Ceres 85 John Deere 4045DRT 4.5 Diesel 1994>2000, Ceres 95 John Deere 4039T 3.9 Diesel 1993>1995

MASSEY FERGUSON: MF-6110 1992-1997, MF-6120 A4.41 1992>1997, MF-6130 1004-4T 1992>1997, MF-6150 1004-4THR 1992, MF-6160 1006-6 1995>1997, MF-6235 1004.40T 1999>2000, MF-6270 1006-60T 1999>2000

CITROËN: Berlingo XUD7 1.8 1996, Berlingo XUD9 1.9 1996, Xantia D8B 1.9 DSI. Turbo 1993>1995, Xsara 161A 1.8 1997>2000, ZX D8A 1.9 DSI. Turbo 1992>1995, Jumper D8C 1.9 DSI. Turbo 1994>2002, Jumper DHX 1.9 DSI. 1994>2002

PEUGEOT: 306 XUD7 1.8 Dsl. 1993>1997, 405 XUD7TE 1.8 Dsl. Turbo 1993>1997, Partner I XUD7 1.8 Dsl. 1996>2002, Partner I XUD9 1.9 Dsl. 1996>2002, Boxer XUD9 1.9 1994

LANDINI: Globus 55 Perkins 903-272 2.3 0000, Globus 65 Perkins 1004-40 4.0 0000, Globus 75 Perkins 1004-42 4.0 0000, Mythos 100 Perkins 1004-40T 4.0 0000, Mythos 90 Perkins 1004-40T 4.0 0000

CASE: CS660 Cummins 8.3 TAA 209kW 2004, MXM120 6-456 Diesel 2002>2007, MXM190 6-456 Diesel 2002>2008

ALTERNATOR / ALTERNATOR:

AGCO SISU POWER: 3788 017 M92, 3821 976 M92, 3821 977 M91, 3821 978 M91, 3823 654 M2, 3909 794 M1, 4271 312 M91, 4279 541 M92

CASE: 87361085

LANDINI: 3564073M91, 3655838M91

MASSEY FERGUSON: 4271 312 M93

CITROËN/PEUGEOT: 5.71E11, 5705J0, 5705T8, 5705Y1, 95667748

RENAULT: 7700071558, 7700036536, 7700068501

ISKRA
GA436

FEATURES / CARACTERÍSTICAS: 28V, 'A' Circuit

REPLACES / REEMPLAZA:

Cargo: 235509; **AS-Poland:** ARE9054

APPLICATION / APLICACIÓN:

DAEWOO: Heavy Industry

ALTERNATOR / ALTERNATOR:

ISKRA / LETRIKA: 11201708, 11201761, 11201762, 11201894, 11203061, 11203155, 11203215, 11203273, 11203278, 11203396, 11203399, 11203421, 11203570, 11203571, 11203573, 11203655, 11203893, 11204035, 11204040, 11204043, 11204044, 11204197, 11204412, AAK5120, AAK5134, AAK5135, AAK5170, AAK5334, AAK5376, AAK5517, AAK5531, AAK5532, AAK5565, AAK5568, AAK5576, AAK5714, AAK5715, AAK5717, AAK5734, AAK5767, AAK5792, AAK5797, AAK5801, AAK5802, AAK5816, AAK5832

ISKRA
GA444

FEATURES / CARACTERÍSTICAS: 14V, 'A' Circuit

REPLACES / REEMPLAZA:

Iskra: 11 125 204, 11 125 165, AER1613; **Cargo:** 231044

APPLICATION / APLICACIÓN:

Combine and Tractors

ALTERNATOR / ALTERNATOR:

...

ISUZU
GA904

FEATURES / CARACTERÍSTICAS: 28V, 'A' Circuit

REPLACES / REEMPLAZA:

Isuzu: 897112646

APPLICATION / APLICACIÓN:

GM: GMC 7110

ALTERNATOR / ALTERNATOR:

...

JINBEI
GA903

FEATURES / CARACTERÍSTICAS: 14V, 'B' Circuit

REPLACES / REEMPLAZA:

Valeo: 2655006, 20071017, 20080622; **Transpo:** M563; **Regitar:** VRPR5011; **Mobiletron:** VR-PR5011

APPLICATION / APLICACIÓN:

KIA: Sorento V6, Van Sedona V6 2003>2005

ALTERNATOR / ALTERNATOR:

Hyundai: 37300-39400, 37300-39435, 37300-39435RU, 37300-39450, 37300-39450RU

KIA: 37300-39435, 37300-39435R

LADA
GA456

FEATURES / CARACTERÍSTICAS: 14V 'A' Circuit, Setpoint: 14.5±0.3V [6000RPM @25A load]

REPLACES / REEMPLAZA:

LADA: 57.3702, 94.3701

APPLICATION / APLICACIÓN:

LADA: 2110 (Russia)

ALTERNATOR / ALTERNATOR:

VAZ: 2110-3701010, 2112-370101; **GAZ:** 32123771, 3212M3771

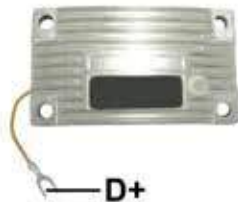
LEECE-NEVILLE
GA600

FEATURES / CARACTERÍSTICAS: 14V 'A' Circuit, D+, DF and D-

REPLACES / REEMPLAZA:

Leece-Neville: 79000, 102200

APPLICATION / APLICACIÓN:

Bluebird Bus; All Models (By Engine) Caterpillar C7 7.2L 04-06;

All Models (By Engine) Cummins; ISC ; 8.3L 2000-2009

ALTERNATOR / ALTERNATOR:

Leece-Neville: 2300J, 2360J, 2500J, 2600J, 2670J, 2700J, 2800J, 2805J, 4800J, 4806J, 4860J, 4900J

LETRIKA
GA923 // NEW //

FEATURES / CARACTERÍSTICAS: 14V 'A' Circuit

REPLACES / REEMPLAZA:

Mobiletron: VR-PR7736; **Transpo:** IP736; **Cargo:** 136910; **Era:** 215742; **Paris Rhone:** YV7736

APPLICATION / APLICACIÓN:

FARYMAN ENGINE - MARINE: A30M Diesel 0000, K34M Diesel 0000, L38M Diesel 0000, Various Models 0000

MOTOROLA ENGINE - MARINE: Various Models Various Engines 0000

RENAULT ENGINE - MARINE: RC100, D Single Bottom Mount 0000, RC106D, DS Single Bottom Mount 0000, RC140D Single Bottom Mount 0000, RC145DTS Single Bottom Mount 0000, RC160DS Single Bottom Mount 0000, RC180D Single Bottom Mount 0000, RC18D Single Bottom Mount 0000, RC25 Single Bottom Mount 0000, RC25D Single Bottom Mount 0000, RC36D Single Bottom Mount 0000, RC90DS Single Bottom Mount 0000

SABB ENGINE - MARINE: Various Models 0000

VOLVO PENTA: AQ100 4cyl Gas 1961>1963, AQ115A,B,C 4cyl Gas 1969>1977, AQ21A 0000, BB115A,B,C 4cyl Gas 1969>1977, MD5A,B,C 1cyl Diesel 1975>1982, MD7 2cyl Diesel 0000, TMD50A 6cyl Diesel 1965>1971, TMD70B,C 6cyl, 410ci, 6.7L Diesel 1972>1985

ALTERNATOR / ALTERNATOR:

LETRIKA: 11.205.070, 11.205.071; **MOTOROLA:** 9AR2775P, 9AR2775P; **NANNI DIESEL:** 48200932; **PARIS RHONE:** A13N234, A13N259, A13N259M, A13N285M; **PERKINS ENGINE:** 2871A453; **PRESTOLITE:** 66021151M, 66021151M, 66021151M; **VALEO:** 2541451, 2541451, 2541827, 439067, 439067, 439181, 439181, 439485, 510834, 510834, 510839, 518040, 518040, A13N147M, A13N147M, A13N1M, A13N234, A13N234, A13N234, A13N259, A13N259M, A13N259M, A13N285M, A13N285M, A13N285M, A13N2M, A13N2M, A13N57M, A13N57M, A14N1M; **VOLVO:** 3803260-3, 3803260-3, 8722357, 8722357; **VOLVO PENTA:** 3803227-2, 3803260-3, 872019-5, 872019-5, 872235-7, 872926-1, 873633, 873633, 873633, 873770, 873770, 873770

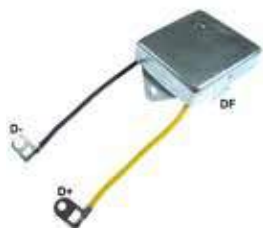
LUCAS
GA030 // NEW //

FEATURES / CARACTERÍSTICAS: 14V, 'A' Circuit

REPLACES / REEMPLAZA:

Ford: 69EB-10316-BA; **Massey Ferguson:** 1887416M1, 1897383M1; **Lucas:** 37534, 37538, 37541, 37555, 37558, 37561; **Cargo:** 130637; **AS-Poland:** ARE4042; **Era:** 215477; **Mobiletron:** VR-LC100; **Transpo:** IL211

APPLICATION / APLICACIÓN:

BEDFORD ENGINE - MARINE: 220/230 0000; **AUSTIN:** Maxi H 1500 1980; **CARBODIES:** FX4R 2.25 22E 1982>1985;

FORD: Escort II 1.1 1975>1980; **MORRIS:** Ital 1.3 1980>1984, Ital Station Wagon 1.3/1.7 1980>1984, Marina II Station Wagon 1300

1980; **BARBER GREENE:** SB110 Ford 2712E Engine 1972>1984, SB111 Ford 2712E Engine 1973-1984; **LAND ROVER:** Land

Rover L6 2.6L 1972>1974, Range Rover V8 3.5L 1972>1974; **SUNBEAM:** Alpine L4 1.7L 1969>1970, Arrow L4 1.7L 1969>1970;

TRIUMPH: TR250 L6 2.5L 1968; **PLYMOUTH:** Cricket L4 1.5L 1971>1973; **MASSEY FERGUSON:** MF-1200 1971>1972, MF-44B Wheel Loader 1971>1977

ALTERNATOR / ALTERNATOR:

LUCAS: 23554, 23562A, 23563, 23563A, 23565, 23565A;

FORD: 2400E-10346-C, 69ZB-10300-AA, D0RY-10346-A, D0RY-10346-B, D1RY-10346-D, D69ZB-10300-A;

MASSEY FERGUSON: 1096-462-M91, 3743-639-M91

LUCAS
GA172 // NEW //
FEATURES / CARACTERÍSTICAS: 14V, 'A' Circuit

REPLACES / REEMPLAZA:
Lucas: 37624, 37636, 37640, 37661, 37666, 37666A, 37666B, 37667, 37686, 37689, 37690, 37709, 60211172, UCB129, UCB133, UCB134, UCB137, UCB139, UCB142; **Mobiletron:** VR-LC200; **AS-Poland:** ARE4049; **Era:** 215480; **Transpo:** IL219

APPLICATION / APLICACIÓN:
AGCO WHITE TRACTOR: 6410/6510 Cummins 3.9L 1998>2000, 6710/6810 Cummins 6-359 1998>2000

AUSTIN: Montego 2.0 1984>1988, Montego Estate 1.9 1988>1992

CASE: 1394/1494 4-219 Diesel 1983>1988, 1594 6-329 Diesel 1983>1988, 695 4-239 Diesel 3.9 1991>1994, 995 4-268 Diesel 1991>1994

CATERPILLAR Ag. & Ind. GENERATOR SET: D25P1 Perkins 3.1524 Dsl. 2004>2007

CATERPILLAR Ag. & Ind. PAVING EQUIPMENT: BB621C C2.2, 2.216L Caterpillar Dsl. 2005-2010

J.C. BAMFORD EXCAVATOR: 811 Perkins 6-354 1985>1988, 812 Perkins 6-354 1985>1990, 820 Perkins 6-354 1985>1990

J.C. BAMFORD LIFT TRUCK: 926 Perkins 1004 1989>1998, 930 Perkins 4-243 1986>2007, 940 Perkins 4-243 1992>2007

LAND ROVER - EUROPE TRUCK: 109 3500 1979>1985, Range Rover 2400 1986>1988, Range Rover 3500 V8 1976>1984

PERKINS GENERATOR: Various Models 1000 1992>2006, Various Models 3.152 1979, Various Models 903-27 3cyl Engine 0000

MAHINDRA Ag. and Id. TRACTOR: 2810 10 Series 2002>2006, 4025 25 Series 2008>2012, 5500 00 Series 2002>2008, 6530 30 Series 2008>2012

JAGUAR: XJ6 3400 1982>1986, XJ6 4200 1982>1986

MASSEY FERGUSON AGRICULTURAL TRACTOR: MF-194-4 1979>1992, MF-274-4 Perkins AD4-236 Diesel 1982>1986, MF-294-4 Perkins 6-358 Diesel 1982>1986

ALTERNATOR / ALTERNATOR:
LUCAS: 23865, 23865A, 23876, 23876A/B, 23880, 23880A, 23929, 23967, 23967A, 23971, 23971A, 24019, 24019A, 24022, 24022A, 24026, 24037, 24037A, 24037A/B; **CASE:** 92281C1, 92292C1, 92293C1, K307720, K311696, K311697, K311698; **FORD:** 75AB-10300-UA, 78BB-10300-AA, 78GB-10300-BA, 86FB-10300-AA; **JAGUAR:** AEU-1929, AEU-1929E, AEU-1929N, AEU-1930N, DAC-3378, JLM-153, JLM-153E, JLM-276, JCB 714/20400; **LAND ROVER:** ADU8880, ADU9548, ADU9750, AJU1957, ASU1693, RCT5053, RTC5053, YLE10067, YLE101570, YLE101580; **MAHINDRA:** 40001C01, 556267R91; **MASSEY FERGUSON:** 1447110R91, 1897-264-M91, 3473-639-M91

LUCAS
GA148
FEATURES / CARACTERÍSTICAS: 14V / 75A, 'A' Circuit

REPLACES / REEMPLAZA:
Lucas: UCB148, UCB150, UCB151, 37701, 37703, 37705, 37707, 54205986, 54206177, 5420448, 5420467, 5420645; **Regitar:** VRLC111; **Cargo:** 131277; **WAI/Transpo:** IL223, IL223B; **AS Poland:** ARE4001, **Huco/Hitachi:** 130820

APPLICATION / APLICACIÓN:
FORD: Fiesta;

MF: Tractors;

JI CASE
ALTERNATOR / ALTERNATOR:
LUCAS: 24145, 24156, 24157, 24158, 24161, 24169, 24198, 24199, 24200, 24206, 24207, 24208, 24223, 24127

RECTIFIER:
GA1138

LUCAS
GA149
FEATURES / CARACTERÍSTICAS: 28V 'A' Circuit

REPLACES / REEMPLAZA:
Lucas: 54022415, 84 959, UCB155; **Regitar:** VRLC111B; **Cargo:** 135231; **WAI/Transpo:** IL225; **AS Poland:** ARE4002

APPLICATION / APLICACIÓN:

Vehicles with alternators LUCAS

ALTERNATOR / ALTERNATOR:
LUCAS: NAB903, A127, 24299; **MAGNETI MARELLI:** 54022415, 54022578, 63324299, 63324406, NAB901, 24406

LUCAS
GA150
FEATURES / CARACTERÍSTICAS: 14V 'A' Circuit

REPLACES / REEMPLAZA:
Delco/Ford: E7NN10316AA, E7NNA; **Ford:** E3NN10B376AD, E7NN10316AA; **Lucas:** 28006, 37735, UCB153;

APPLICATION / APLICACIÓN:
FORD: TRACTOR, MASSEY FERGUSON, EQUIPOS JCB, WITH LUCAS 12V ALTERNATOR

ALTERNATOR / ALTERNATOR:
FIAT/MARELLI: 54022310, 54022336, 54022337, 54022397, 54022420, 54022481, 63324256, 63324273, 63324274, 63324295, 63324311; **LUCAS:** 24246, 24246A, 24246B, 24256, 24256A/C, 24258, 24258A, 24273, 24273A, 24274, 24274A, 24276, 24277, 24278, 24278A, 24279, 24279A, 24295, 24295A, 29295, 29295A, 54022336;

LUCAS
GA695

FEATURES / CARACTERÍSTICAS: 14V / 55A, 'A' Circuit

REPLACES / REEMPLAZA:

Lucas: 353.81.695

APPLICATION / APLICACIÓN:

FORD: F100 and F4000;
Several Argentinean Vehicles

ALTERNATOR / ALTERNATOR:

LUCAS: 352.13.295, 352.13.740, 352.13.800, 352.13.855, 352.13.352, 352.14.090

LUCAS
GA720

FEATURES / CARACTERÍSTICAS: 14V / 85A, 'A' Circuit

REPLACES / REEMPLAZA:

Lucas: 353.81.720

APPLICATION / APLICACIÓN:

FORD: Escort, Verona, Orion 1.8;
VW: Pointer 1.8 Gol w/motor AP;

GM: D20

ALTERNATOR / ALTERNATOR:

LUCAS: 352.13.795, 352.13.940, 352.13.995, 352.14.100

LUCAS
GA901

FEATURES / CARACTERÍSTICAS: 14V, 'A' Circuit

REPLACES / REEMPLAZA:

Lucas: UCB901; **Magneton:** 443 930 134 291, 443 930 136 111, 443 930 136 131; **Regitar:** VRMP134; **Cargo:** 133417; **WAI/Transpo:** MP291

APPLICATION / APLICACIÓN:

SKODA; JOHN DEERE; INGERSOLL;

ALTERNATOR / ALTERNATOR:

443 113 516 610, 443 113 516 611, 443 113 516 614, 443 113 516 620, 443 113 516 623, 443 113 516 636, 443 113 516 660, 443 113 516 662, 443 113 516 668, 443 113 516 670, 443 113 516 673, 443 113 516 700, 443 113 516 701, 443 113 516 710, 443 113 516 711, 443 113 516 714, 443 113 516 720, 443 113 516 721, 443 113 516 730, 443 113 516 731, 443 113 516 733, 443 113 516 734, 443 113 516 738, 443 113 516 740, 443 113 516 741, 443 113 516 743, 443 113 516 744, 443 113 516 748, 443 113 516 750, 443 113 516 752, 443 113 516 760, 443 113 516 761, 443 113 516 762, 443 113 516 764, 443 113 516 765, 443 113 516 780, 443 113 516 781, 443 115 516 661, 443 413 516 630, 443 113 516 610

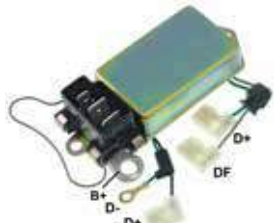
LUCAS
GA540

FEATURES / CARACTERÍSTICAS: 14V / 65A, 'A' Circuit

REPLACES / REEMPLAZA:

Lucas: 353.81.540

APPLICATION / APLICACIÓN:

FORD: Escort 1.8 with motor AP1800 with AC., Escort Guarujá, Brasil, Versailles with or without AC., Galaxie Ghia Full with motor 1.8 827;
VW: Santana 2.0 with motor Ap2000 with or without AC., Gacel, Carat, Senda, Gol CL, Gol GL (with motor **VW** 827 1.8), Gol BR.

ALTERNATOR / ALTERNATOR:

LUCAS: 352.13.790, 352.13.865, 352.13.970

RECTIFIER:

GA1273

LUCAS
GA610

FEATURES / CARACTERÍSTICAS: 14V / 70A, 'A' Circuit

REPLACES / REEMPLAZA:

Lucas: 353.81.610, 353.81.715

APPLICATION / APLICACIÓN:

SEVEL: Sevel; **Fiat:** Duna, Uno;
FORD: Truck F 350, Pick-Up, F 1000

ALTERNATOR / ALTERNATOR:

LUCAS: 352.13.385, 352.13.415, 352.3.510, 352.14.075, 352.13.845, 91 TR-10300A

RECTIFIER:

GA1271

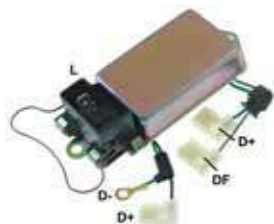
LUCAS
GA640

FEATURES / CARACTERÍSTICAS: 28V / 90A, 'A' Circuit

REPLACES / REEMPLAZA:

Lucas: 353.81.640

APPLICATION / APLICACIÓN:

EL DETALLE: Bus;

MERCEDES BENZ: Bus and Trucks;

SCANIA: Bus and Trucks, Agricultural Machinery

ALTERNATOR / ALTERNATOR:

LUCAS: MO 240 90R, MB 240 55R, MB 240 90R, 5C 240 55R, 5C 240 90R, 9120 456 003, B 0120 46 9001, B 9120 45 6034, 0 120 46 9920

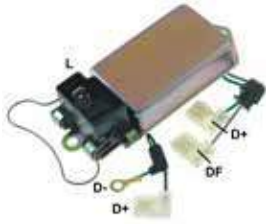
LUCAS
GA645

FEATURES / CARACTERÍSTICAS: 14V / 100A, 'A' Circuit

REPLACES / REEMPLAZA:

Lucas: 353.81.645

APPLICATION / APLICACIÓN:

MERCEDES BENZ: Bus e Trucks;

SCANIA: Bus, Trucks e Agricultural Machinery;

SEVEL: Engines Peugeot;

ZANELLO: Various

ALTERNATOR / ALTERNATOR:

LUCAS: 121 00R, 5C 121 00R, 9120 456 003

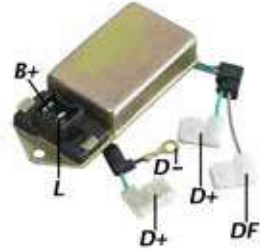
LUCAS
GA690

FEATURES / CARACTERÍSTICAS: 14V / 70A, 'A' Circuit

REPLACES / REEMPLAZA:

Lucas: 35381690, 35381715, 35313 680

APPLICATION / APLICACIÓN:

FORD: F-1000 (Emax 221 - alc. Gas.), Sierra XR4, Ghia, Rural 2.3 w/ AC, Sierra 2.3 with AC., F100 6 cil. Nafta (after 91);

RENAULT: Trafic Furgão Diesel TA12, TA52, T312 and T352 ,R9, R11, Trafic (w/ motor 1400). Diesel, R9, R11, R18, Break (w/ motor 1600)

R18, Fuego Trafic w/ motor 2000 (w/AC ou without AC.) R18, R21, Fuego (w/ motor 2200);

FIAT: Trucks Diesel (Argentinos) subs.

ALTERNATOR / ALTERNATOR:

LUCAS: 352.13.680, 352.13.845

RECTIFIER:

GA1271

LUCAS
GA700

FEATURES / CARACTERÍSTICAS: 14V / 90A, 'A' Circuit

REPLACES / REEMPLAZA:

Lucas: 353.81.700

APPLICATION / APLICACIÓN:

RENAULT: Trafic Linea, TA52, T352 luxu with AC and engine 2000

ALTERNATOR / ALTERNATOR:

LUCAS: 352.13.685

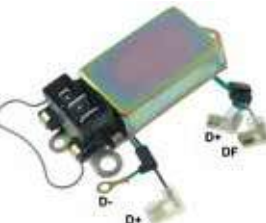
LUCAS
GA705

FEATURES / CARACTERÍSTICAS: 14V / 55A, 'A' Circuit

REPLACES / REEMPLAZA:

Lucas: 353.81.705; **Magneti Marelli:** RT510179

APPLICATION / APLICACIÓN:

FORD: Escort Guarujá, Hobby L and GL w/ motor CHT 1.6 and 1.0, Escort Guarujá, Hobby L and GL w/ motor CHT 1.6 with AC;

VW: Gol 1000 CHT, Gol / Voyage / Saveiro 1.6 CHT , Gol, Voyage, Saveiro with AC.;

ALTERNATOR / ALTERNATOR:

LUCAS: 352.13.725, 352.13.730

RECTIFIER:

GA1274

LUCAS
GA725

FEATURES / CARACTERÍSTICAS: 14V / 100A, 'A' Circuit

REPLACES / REEMPLAZA:

Lucas: 353.81.725

APPLICATION / APLICACIÓN:

DEUTZ: Bus;

FORD: Fiesta, Fiesta 1.4 with or without AC;

MERCEDES BENZ: Bus and Trucks

ALTERNATOR / ALTERNATOR:

LUCAS: 352.13.690, 352.14.305, 372.15.07250

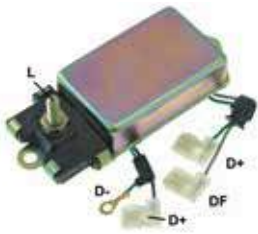
LUCAS
GA760

FEATURES / CARACTERÍSTICAS: 14V / 70A, 'A' Circuit

REPLACES / REEMPLAZA:

Lucas: 353.81.760

APPLICATION / APLICACIÓN:

BORGWARD: Engines;

FORD: Trucks;

MERCEDES BENZ: Bus

ALTERNATOR / ALTERNATOR:

LUCAS: 352.14.390, 352.14.375, 352.14.560

LUCAS
GA964 // NEW //

FEATURES / CARACTERÍSTICAS: 14V, 'B' Circuit

REPLACES / REEMPLAZA:

Cargo: 234744; **Mobiletron:** VR-LC112

APPLICATION / APLICACIÓN:

Motores Ashok Leyland Iveco TCL / KOEL, Indica SR60, INDICA, INDIGO, SUMO, M & M

ALTERNATOR / ALTERNATOR:

LUCAS: 2193818A, 26938161A, 26938181A, SR60

LUCAS
GA990

FEATURES / CARACTERÍSTICAS: 14V / 55A, 'A' Circuit

REPLACES / REEMPLAZA:

Lucas: 353.81.990; **Magneti Marelli:** RT510249

APPLICATION / APLICACIÓN:

Vehicles with alternators Lucas

ALTERNATOR / ALTERNATOR:

...

RECTIFIER:

GA1273 / GA1274

MAGNETI MARELLI
GA102 // NEW //

FEATURES / CARACTERÍSTICAS: 14V, 'A' Circuit

REPLACES / REEMPLAZA:

Mobiletron: VR-F114A; **Regitar:** VRF114A; **Cargo:** 130652; **AS-Poland:** ARE4009; **Transpo:** IX106

APPLICATION / APLICACIÓN:

ALFA ROMEO: Alfetta 2.0 turbo 1979>1982;

BMW ENGINE - MARINE: Various Models D190 Diesel Engine 1982>1986;

BPM ENGINE - MARINE: 620SH 12.0L 1992

ALTERNATOR / ALTERNATOR:

ALFA ROMEO: 116760506000, 116760506100, AT050600108; **MAGNETI MARELLI:** 063305226010

MAGNETI MARELLI
GA164 // NEW //

FEATURES / CARACTERÍSTICAS: 28V, 'A' Circuit

REPLACES / REEMPLAZA:

Cargo: 130653; **Mobiletron:** VR-F114B; **Regitar:** VRF114B; **Transpo:** IX108

APPLICATION / APLICACIÓN:

FIAT-ALLIS CRAWLERS: 10C 8365 Diesel 1978>1993, 14C 8205 Diesel 1977>1982, 7D CO3 Diesel 1980>1983, 8B CO3 Diesel 1979>1982, FD-20 8215 Diesel 1981>1985;

FIAT-ALLIS EXCAVATOR: S-105B CP3 Diesel 1970>1977, S-11 CP3 Diesel 1976>1982, S-15 8205 Diesel 1970>1982, S-90 CO3 Diesel 1971>1978, SL-11 CP3 Diesel 1976>1982;

FIAT-ALLIS GRADER: 65B 8065 Diesel 1979>1981, 65B 8345 Diesel 1979>1995

ALTERNATOR / ALTERNATOR:

FIAT: 4717870, 4738563, 4738567, 4738568, 4738569, 4738570, 4738571, 4738572, 4786916, 4786918, 4786919, 4786920, 4808519, 5990966

MAGNETI MARELLI
GA103 // NEW //

FEATURES / CARACTERÍSTICAS: 14V, 'A' Circuit

REPLACES / REEMPLAZA:
Mobiletron: VR-F159; **Regitar:** VRF159; **AS-Poland:** ARE4022; **Cargo:** 239983; **Transpo:** IX595

APPLICATION / APLICACIÓN:
ALFA ROMEO: Mito 1.3 D MultiJet 2009, Mito 199B4.000 2011>2013

MINI: Cooper N12B16 2007>2012

OPEL: Astra H Z13DTH 2005>2010

VAUXHALL: Astra MkV Z13DTH 2005>2010

FIAT: 500 1.3 D MultiJet 2009, Doblo box body/estate 1.3 D MultiJet 2010, Fiorino box body/estate 1.3 D MultiJet, Punto Evo 1.3 D MultiJet 2009>2012, Qubo 1.3 D MultiJet 2009

ALTERNATOR / ALTERNADOR:
MAGNETI MARELLI: 063377409010, 063377495010, 63377495; **FIAT:** 51854912; **CHEVROLET:** 13117340, 13256928, 93169260;

OPEL: 1204434, 12759595, 13117236, 13153236, 13153237, 93169259, YZ13153237; **VAUXHALL:** 93190915

MAGNETI MARELLI
GA110

FEATURES / CARACTERÍSTICAS: 14V, 'A' Circuit

REPLACES / REEMPLAZA:
Magneti Marelli: RTM300.01, 85563491; **Transpo:** IX491; **Regitar:** VRF157; **Cargo:** 238265; **Mobiletron:** VR-F157

APPLICATION / APLICACIÓN:
CITROËN: Berlingo 1.4 2002>2005, Jumpy Box 1.9 1996>1998, Nemo Box 1.4 2008, Nemo Estate 1.4 2009, Xsara 1.4/1.6 2000>2005, Xsara Picasso 1.6 8V 2000>2006, Berlinbo LCV 1.4/1.6/1.9 2000>2008, Dispatch 1.9 2001>2007, C-Elysee 1.6 2012, C2 1.4 2006>2010, C3 1.4 2005>2010, C3 1.6 16V 2003>2005, Saxo 1.0/1.1/1.4/1.6 1999>2004

PEUGEOT: 106 1.1/1.4/1.6 1999>2003, 206 1.1/1.4/1.6/1.9/2.0 1998>2010, 607 2.0 16V 2001>2005, Partner Combi 1.4/1.6/1.9 2001>2005

ALTERNATOR / ALTERNADOR:
MAGNETI MARELLI: 63321733, 63321828, 63341733, MAN1164

CITROËN: 57057F, 5705FA, 9638275780, 9638544580, 9642879680, 9642880180, 9649611880, 9656956280

PEUGEOT: 9633782580, 9634561280, 9635557780, 9637075380, 9638827580, 9641398480

MAGNETI MARELLI
GA114

FEATURES / CARACTERÍSTICAS: 14V, 'A' Circuit

REPLACES / REEMPLAZA:
Magneti Marelli: RTM200.01, RTM300.07, 85562731, 85562881, 85562991; **Regitar:** VRF158; **Cargo:** 236579; **Mobiletron:** VR-F158

APPLICATION / APLICACIÓN:
ALFA ROMEO: 159 1.8 2009>2011, Brera 1.8 2009>2016, Giulietta 1.8 2010>2016, Mito 1.4 2009>2016, Spider 1.8 2009>2016

FIAT: Stilo 1.8 16V 2001>2007, Doblo 1.2 2001>2005, Panda 1.1/1.2 2004>2006, Punto 1.1/1.2 1994>2003, Seicento 1.1 1994>2004, Fiorino 1.3 2008>2015;

LANCIA: Ypsilon 1.3 2006>2015, Kappa SW 2.4 1996>2001, Lybra 1.9/2.4 1999>2005, Musa 1.9D 2004>2012

OPEL: Agila A 1.3 2003>2008, Combo C 1.3 16V 2004>2015, Corsa C 1.3 2003>2006, Meriva A 1.3 2003>2010, Tigra B 1.3 2004>2015

SUZUKI: Ignis II 1.3 2003>2015

ALTERNATOR / ALTERNADOR:
MAGNETI MARELLI: 63321491, 63321858; **ALFA ROMEO:** 46445658, 51793678, 51817369, 51854898, 51854902; **FIAT:**

46231671, 46407647, 46420960, 46430529, 46430531, 46530060, 46530261, 46543023, 4670238, 46709067, 46740238, 46763532,

46765836, 46800158, 46813059, 46843091, 46843093, 51709133, 51714794, 51793678, 51817369, 51854898, 51854902, 60812535,

60812713, 60816760, 7781075, 7782314; **LANCIA:** 51817369, 51854898; **OPEL:** 1204436, 6204188, 93169032, 93169033, 93169258,

93180102, 9562209; **SUZUKI:** 13256930, BA13256930

MAGNETI MARELLI
GA115

FEATURES / CARACTERÍSTICAS: 14V, 'A' Circuit

REPLACES / REEMPLAZA:
Magneti Marelli: RTM300.11; **Denso:** 126600-7200; **AS Poland:** UD805135

APPLICATION / APLICACIÓN:
TOYOTA: Avensis 1.6/1.8 2000>2010, Corolla 1.4/1.6 1999>2010, Corolla Verso 1.6 2001>2004

ALTERNATOR / ALTERNADOR:

...

MAGNETI MARELLI
GA116

FEATURES / CARACTERÍSTICAS: 14V, 'A' Circuit

REPLACES / REEMPLAZA:
Magneti Marelli: 836 031 51010; **Seat:** SE1411903019A; **Lucas:** UCB811; **Cargo:** 138795; **WAI/Transpo:** IX112

APPLICATION / APLICACIÓN:
SEAT: Ibiza 1.2, 1.5;

Malaga 1.2, 1.5

ALTERNATOR / ALTERNADOR:
MAGNETI MARELLI: 63320029010, 63321059010, 63320029, 63321059; **SEAT:** 021903020AX, SE021903020A, SE021903020AX, X0039532430, X039415730, X039521210

MAGNETI MARELLI
GA117

FEATURES / CARACTERÍSTICAS: 28V, 'A' Circuit

REPLACES / REEMPLAZA:
Magneti Marelli: 797 074 41, RTT 119 B; **Fiat:** 8 190 407; **Lucas:** 21222126, UCB 806; **VL-Ducellier:** 592 968.; **Regitar:** VRF119B; **Cargo:** 131286; **WAI/Transpo:** IX111; **AS Poland:** ARE4006; **Huco/Hitachi:** 130795

APPLICATION / APLICACIÓN:
FIAT: Tractors

ALTERNATOR / ALTERNATOR:
MAGNETI MARELLI: 633 200 25, 633 200 52, 633 200 57, 633 201 18, 633 210 46, 633 210 48, 633 210 49, 633 210 50, 633 210 52, 633 210 55, 633 210 63, 633 211 02, 633 211 04, 633 211 10; **PIC:** 20211

RECTIFIER:

GA1500

MAGNETI MARELLI
GA118

FEATURES / CARACTERÍSTICAS: 14V / 90A, 'A' Circuit

REPLACES / REEMPLAZA:
Magneti Marelli: 648 081 82, 648 081 84, 648 082 41, 648 082 43, 836 070 41, 836 071 11, RTT 118 C, RTT 118 E, RTT 118 J; **Regitar:** VRF118; **Cargo:** 133956; **WAI/Transpo:** IX118; **AS Poland:** ARE4007; **Huco/Hitachi:** 130791; **Magneti Marelli:** RT510096

APPLICATION / APLICACIÓN:
RENAULT: Trafic;

FIAT: Tipo, Tempra

ALTERNATOR / ALTERNATOR:
MAGNETI MARELLI: 063320027010, 063320039010, 063320041010, 063321057010, 063321081010, 063321083010, 063320027039, 063320027041, 063320027, 063320039, 063320041, 063321057, 063321081, 063321083

MAGNETI MARELLI
GA119

FEATURES / CARACTERÍSTICAS: 14V / 65A, 'A' Circuit

REPLACES / REEMPLAZA:
Magneti Marelli: 79707161, 79707481, RTT 119A; **Fiat:** 83600151, 9939826, 9941193; **Regitar:** VRF119; **Cargo:** 131283; **WAI/Transpo:** IX110; **AS Poland:** ARE4003; **Huco/Hitachi:** 130790; **Magneti Marelli:** RT510097

APPLICATION / APLICACIÓN:
FIAT: Uno, Tipo 1.6 / 2.0 Tempra with alternator Magneti Marelli, Elba, Fiorino.

ALTERNATOR / ALTERNATOR:
MAGNETI MARELLI: AA125R, 633 211 05, 633 200 Séries, 633 210 Séries, 063300010010, 063320001010, 063320002010, 063320003010, 063320004010, 063320005010, 063320006010, 063320007010, 063320008010, 063320010010, 063320011010, 063320012010, 063320013010, 063320014010, 063320015010, 063320016010, 063320017010, 063320020010, 063320021010, 063320022010, 063320023010, 063320024010

RECTIFIER:

GA1501 / GA1504

MAGNETI MARELLI
GA120

FEATURES / CARACTERÍSTICAS: 14V, 'A' Circuit

REPLACES / REEMPLAZA:
Magneti Marelli: RTT121A, 542 093 05, 836 142 51, 836 142 51010, 000 280 01, 58120056, 24TRB; **Regitar:** VRF121; **WAI/Transpo:** IX127; **AS Poland:** ARE4008; **Huco/Hitachi:** 130796; **Magneti Marelli:** RT510098

APPLICATION / APLICACIÓN:
FIAT: Punto, Palio, Tempra;

LAND ROVER: 820 2.0 Diesel

ALTERNATOR / ALTERNATOR:
MAGNETI MARELLI: 054022375010, 054022437010, 054022443B010, 054022510010, 054022536010, 054022591010, 054022646010, 054022647010, 054022651010, 054022286010, 054022322010, 054022374010, 054022380010, 054022390010, 064022656010, 54022375, 54022437, 54022438, 54022443B, 54022510, 54022536, 54022591, 54022646, 54022647, 54022651, 54022653, 63324233, 63324286, 63324322, 63324374, 63324380, 63324390, 64022656, 64280325, 64280328

MAGNETI MARELLI
GA121

FEATURES / CARACTERÍSTICAS: 14V, 'A' Circuit

REPLACES / REEMPLAZA:
Magneti Marelli: 581 200 5300, 581 200 5600, 836 113 61, 855 61291, 855 612 91010, RTM 121 A; **Regitar:** VRF151A; **Cargo:** 136432; **WAI/Transpo:** IX121; **AS Poland:** ARE4004; **Huco/Hitachi:** 130797; **Magneti Marelli:** RT510099

APPLICATION / APLICACIÓN:
FIAT: Punto, Palio, Tempra, Selecta, Corsa, Celta, Prisma, Classic 95>09

ALTERNATOR / ALTERNATOR:
MAGNETI MARELLI: 063320203010, 063320204010, 063320219010, 063320227010, 063320238010, 63321205010, 63321234010, 63321235010, 63320200, 63320203, 63320204, 63320219, 63320227, 63320238, 63321205, 63321234, 63321235, 63321281; **GM:** 93260364, 93339575, 93390879

RECTIFIER:

GA1301 / GA1302

MAGNETI MARELLI
GA122

FEATURES / CARACTERÍSTICAS: 14V, 'A' Circuit

REPLACES / REEMPLAZA:
Magneti Marelli: RTM153B, 083617181010, 083618371010, 085561921010; **Regitar:** VRF153A, VRF160; **Cargo:** 138789, 233636; **WAI/Transpo:** IX123, IX594; **AS Poland:** ARE4005, ARE4013; **Huco/Hitachi:** 130799; **Magneti Marelli:** RT510100; **Mobiletron:** VR-F160

APPLICATION / APLICACIÓN:
FORD: Escort, Scorpio, Transit, Fiesta;

LAND ROVER: Range Rover 3.9, Discovery 2.5, Discovery Country, Discovery Luxury;

MAZDA: 121 III;

Tractors: New Holland, Massey Ferguson;

Engines: Perkins;

SMART: Cabrio (450) Eng.M 160 E6AL B03, M 160.920 0.6 (S1OLA1, 450.441, 450.442, 450.443) 40kw M 160, Cabrio (450) Eng.M 160.910 0.7 (450.433) 55kw M 160.910 2003>2004, City Coupe (450) Eng.M 160 E6AL B03, M 160.920 0.6 (S1CLA1, 450.341) 40kw M 160 E6AL B03; M 160.920 1999>2003, Fortwo Cabrio (450) Eng.M 160.910 0.7 (450.433) 55kw M 160.910 2004>2007, Roadster (452) Eng.M 160.922 0.7 (452.434) 60kw M 160.922 2003-2005, Smart City-Coupe 0.7L (450.336, 450.352, 450.353) 2004

ALTERNATOR / ALTERNATOR:
FORD: 5026722, 91FF10300JA, 91FF10300JB, 95FF10300AA, 95FF10300AB, 95FF10300AC, A002TA2292, R91FF10300JA, 95GB10300MA, 95GB10300MB, R95GB10300MA, R95GB10300MB, 1058821, 7312901; **MAGNETI MARELLI:** 54022669010, 54022549010, 63320228010, 63321240010, 63341345010, 63321352, 63320281010, 63320243010, 63321244010, 63341346010, 63321353, 63320287010, 63320335010, 63321257010, 63341347010, 63321666, 63320288010, 63320336010, 63321321010.; **MERCEDES-BENZ:** A1601540301, A1601540401, A1601540501, A1601540601; **SMART:** 0002801V005, 0002801V006, 0003250V009, 0003250V010, 0003250V011

RECTIFIER:

GA1301

MAGNETI MARELLI
GA122R

FEATURES / CARACTERÍSTICAS: 14V, 'A' Circuit

REPLACES / REEMPLAZA:
Magneti Marelli: RTM153B, 083617181010, 083618371010, 085561921010; **Regitar:** VRF153A; **Cargo:** 138789; **WAI/Transpo:** IX123; **AS Poland:** ARE4005; **Huco/Hitachi:** 130799; **Magneti Marelli:** RT510100

APPLICATION / APLICACIÓN:
NEW HOLLAND: Harvester TC59C, Tractors 8010 /8160 /8360 /8560

ALTERNATOR / ALTERNATOR:
FORD: 5026722, 91FF10300JA, 91FF10300JB, 95FF10300AA, 95FF10300AB, 95FF10300AC, A002TA2292, R91FF10300JA, 95GB10300MA, 95GB10300MB, R95GB10300MA, R95GB10300MB, 1058821, 7312901; **MAGNETI MARELLI:** 54022669010, 54022549010, 63320228010, 63321240010, 63341345010, 63321352, 63320281010, 63320243010, 63321244010, 63341346010, 63321353, 63320287010, 63320335010, 63321257010, 63341347010, 63321666, 63320288010, 63320336010, 63321321010, 63321347; **DENSO:** 82001259, 82002329

RECTIFIER:

GA1301

MAGNETI MARELLI
GA123

FEATURES / CARACTERÍSTICAS: 14V 'A' Circuit

REPLACES / REEMPLAZA:
Magneti Marelli: 08556280100, 085582601010, 85562801, 85562541; **Cargo:** 230790; **Regitar:** VRF156; **Cargo:** 230790; **WAI/Transpo:** IX131, IX131HD; **AS Poland:** ARE4011; **Huco/Hitachi:** 130771; **Magneti Marelli:** RT510101

APPLICATION / APLICACIÓN:
CUMMINS;
VW;
FORD: C-Max 1.6 TDCi 02.07>, 2.0 TDCi 02.07>, Fiesta V 1.6 TDCi 11.04>, Focus C-Max 1.6 TDCi 02.05>03.07, 10.03>03.07, 2.0 TDCi 10.03>03.07, Focus II 1.6 TDCi 01.05>, 11.04>, 2.0 TDCi 11.04>, II Cabriolet 2.0 TDCi 10.06>, II Stufenheck 1.6 TDCi 04.05>, 2.0 TDCi 04.05>, II Turnier 1.6/ 2.0 TDCi 11.04>, Focus 1.8, 2.0 00>05, Fusion 1.6 TDCi 11.04>;

MAZDA: 3 (BK14) 1.6 DI Turbo 06.04>;

VOLVO: C30 1.6 10.06>, 2.0 10.06>, S40 II (MS) 1.6 01.05>, 2.0 01.04>, V50 (MW) 1.6 01.05>, 2.0 04.04>.

ALTERNATOR / ALTERNATOR:
MAGNETI MARELLI: 63321677, 63321678, 63321679, 63321746, 63341677, 63341679, 63341746; **FORD:** 98AB10300DI, 98AB10300GD; **VALEO (PARIS RHONE):** A1151;

RECTIFIER:

GA1303

MAGNETI MARELLI
GA123S

FEATURES / CARACTERÍSTICAS: 14V 'A' Circuit - Without sense function

REPLACES / REEMPLAZA:

Magneti Marelli: 08556280100, 085582601010, 85562801, 85562541; **Cargo:** 230790; **Regitar:** VRF156; **Cargo:** 230790; **WAI/Transpo:** IX131, IX131HD; **AS Poland:** ARE4011; **Huco/Hitachi:** 130771

APPLICATION / APLICACIÓN:

CUMMINS;

VW;

FORD: C-Max 1.6 TDCi 02.07>, 2.0 TDCi 02.07>, Fiesta V 1.6 TDCi 11.04>, Focus C-Max 1.6 TDCi 02.05>03.07, 10.03>03.07, 2.0 TDCi 10.03>03.07, Focus II 1.6 TDCi 01.05>, 11.04>, 2.0 TDCi 11.04>, II Cabriolet 2.0 TDCi 10.06>, II Stufenheck 1.6 TDCi 04.05>, 2.0 TDCi 04.05>, II Turnier 1.6/2.0 TDCi 11.04>, Focus 1.8, 2.0 00>05, Fusion 1.6 TDCi 11.04>;

MAZDA: 3 (BK14) 1.6 DI Turbo 06.04>;

VOLVO: C30 1.6 10.06>, 2.0 10.06>, S40 II (MS) 1.6 01.05>, 2.0 01.04>, V50 (MW) 1.6 01.05>, 2.0 04.04>.

ALTERNATOR / ALTERNATOR:

MAGNETI MARELLI: 63321677, 63321678, 63321679, 63321746, 63341677, 63341679, 63341746; **FORD:** 98AB10300DI, 98AB10300GD; **VALEO (PARIS RHONE):** A115I;

RECTIFIER:

GA1303

MAGNETI MARELLI
GA129

FEATURES / CARACTERÍSTICAS: 14V 'A' Circuit

REPLACES / REEMPLAZA:

Magneti Marelli: RTM151C; **Cargo:** 136432; **WAI/Transpo:** IX122; **Huco/Hitachi:** 130797; **Magneti Marelli:** RT510063

APPLICATION / APLICACIÓN:

GM: Corsa >03, Prisma >03, Celta >03 with alternators Denso;

FIAT: Palio, Palio Weekend, Uno, Mille, Strada, Siena, Punto, Linea, All with alternators Denso/M. Marelli 03

ALTERNATOR / ALTERNATOR:

DENSO: 93.390.879

RECTIFIER:

GA1302

MAGNETI MARELLI
GA131

FEATURES / CARACTERÍSTICAS: 14V 'B' Circuit

REPLACES / REEMPLAZA:

DENSO: 270600D190, 270600D140, 2706022230, 270600D170, 270600D140B, 270600D140, 270600D030

APPLICATION / APLICACIÓN:

TOYOTA: Corolla 1.8 VVTi 2008-2011 90A

ALTERNATOR / ALTERNATOR:

DENSO: 270600D140

RECTIFIER:

GA1309

MAGNETI MARELLI
GA132

FEATURES / CARACTERÍSTICAS: 28V, 'A' Circuit

REPLACES / REEMPLAZA:

FIAT: 83614251; 99946065; **Regitar:** VRF121; **Cargo:** 138797; **WAI/Transpo:** IX127; **AS Poland:** ARE4008; **Magneti Marelli:** RT510258

APPLICATION / APLICACIÓN:

CATERPILLAR: Tractors

ALTERNATOR / ALTERNATOR:

MAGNETI MARELLI: 63320025, 63320052, 63320057, 63320118, 63321046, 63321047, 63321048, 63321049, 63321050, 63321052, 63321055, 63321063, 63321102, 63321104, 63321110, 63321429

MAGNETI MARELLI
GA133

FEATURES / CARACTERÍSTICAS: 14V, 'A' Circuit

REPLACES / REEMPLAZA:

Magneti Marelli: 54209305, 83614251, RTM24TR; **Transpo:** IX127; **Regitar:** VRF121; **Cargo:** 138797; **AS Poland:** ARE4008

APPLICATION / APLICACIÓN:

FIAT: Coupé 2000 16V 1995>1996

ALFA ROMEO: Coupé 155 2000 1992>1996

ALTERNATOR / ALTERNATOR:

MAGNETI MARELLI: 63321231, 63321395, 46420963

RECTIFIER:

GA1307

MAGNETI MARELLI
GA151

FEATURES / CARACTERÍSTICAS: 14V, 'A' Circuit

REPLACES / REEMPLAZA:

Fiat: 7088205; **Magneti Marelli:** RTM151C; **Cargo:** 136432; **WAI/Transpo:** IX122; **AS Poland:** ARE4004; **Huco/Hitachi:** 130797

APPLICATION / APLICACIÓN:

FIAT: Idea Atractive 2011>, Fiorino 2014>, Novo Palio 1.0 /1.4 2012>, Novo Uno 1.0 /1.4 2012>, Strada 2009>, Palio /Siena Fire 1.0 /1.4 2009>

ALTERNATOR / ALTERNATOR:

FIAT: 51876424, 51848611, 518469540; **DENSO:** MS101210-1360, MS101210-1590, MS101210-1620, MS101210-1600

RECTIFIER:

GA1302

MANDO
GA417

FEATURES / CARACTERÍSTICAS: 14V, 'A' Circuit

REPLACES / REEMPLAZA:

Mercury: A11883; **Mando:** 809163, 811883, A500C0111; **Transpo:** IM288; **Regitar:** VRH2009-75; **Cargo:** 136742; **AS-Poland:** ARE5099

APPLICATION / APLICACIÓN:

MERCURISER ENGINE MARINE: 420 GM 7.4 1987>1989, 465 GM 8.2 1990>1992

DIVERSOS: Mercury Marine

ALTERNATOR / ALTERNATOR:

MANDO: A000B0331, AC155603

MERCURY: 8171192

MANDO
GA418

FEATURES / CARACTERÍSTICAS: 14V, 'A' Circuit

REPLACES / REEMPLAZA:

Mando: TA500C02001A, TA500C02701; **Transpo:** IY794; **Regitar:** VRH2009-116; **Cargo:** 236638

APPLICATION / APLICACIÓN:

KIA: Sephia L4 1.6L 1994>1995, Europe Car Mentor 1.5 1996>2001, Shuma 1.5/1.8 1999>2001;

MAZDA : 323 1.6 1989>1994, MX3 1.6 1991>1994

ALTERNATOR / ALTERNATOR:

MANDO: AB170036, AB170066, AB180092, AB180085

MANDO
GA419

FEATURES / CARACTERÍSTICAS:

REPLACES / REEMPLAZA:

Bobcat: 6677489; **Mando:** TA500C09001

APPLICATION / APLICACIÓN:

BOBCAT: 5600 Bobcat A220, A300, A300 V3300DI, S130 V2203DI, S175 V2203EB, S185 V2203TEB, S220 V3300DI, S250 V3300DI, S300 V3300T, T190 V2003TEB, T200 BF4M1011F, T300 V3300, X331 V2203EB

HYUNDAI: Accent 1.5L, 1.6 2000-2002, ELANTRA 2.0L 2001-2002

ALTERNATOR / ALTERNATOR:

Mando: AB180128; **Hyundai:** 37300-23600

RECTIFIER:

GA1219

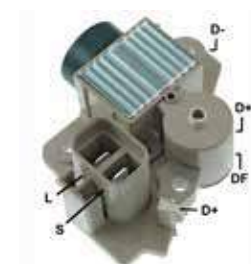
MANDO
GA421

FEATURES / CARACTERÍSTICAS: 14V, 'A' Circuit

REPLACES / REEMPLAZA:

Regitar: VRH2009-86; **Cargo:** 138204; **WAI/Transpo:** IY058; **AS Poland:** ARE9006

APPLICATION / APLICACIÓN:

HYUNDAI: Accent w/1.5L w/DOHC 1997-98, Hyundai Elantra w/1.8L 1996-98, Hyundai Elantra w/2.0L 1999-00, Hyundai Tiburon w/1.8L 1997-98, Hyundai Tiburon w/2.0L 1997-00

ALTERNATOR / ALTERNATOR:

MANDO: AB190058, 3730022200; **LESTER:** 13702; **PIC:** 203304

MANDO
GA422

FEATURES / CARACTERÍSTICAS: 14V, 'A' Circuit

REPLACES / REEMPLAZA:

Regitar: VRMD01; **Cargo:** 139669; **WAI/Transpo:** IY422; **AS Poland:** ARE9002

APPLICATION / APLICACIÓN:

HYUNDAI: 100 Diesel

ALTERNATOR / ALTERNATOR:

HYUNDAI: 3730042017, 3730042114, 3730042116, 3730042202, 3730042203, 3730042206, 3730042303, 3730042802, 3730042804, 3730042Q00, 3730042Q10; **LUCAS:** LRA01499, LRA1499; **MANDO:** AD165202, AD165320, AD165320Q, AD165321

MANDO
GA429

FEATURES / CARACTERÍSTICAS: 14V, 'A' Circuit

REPLACES / REEMPLAZA:

Mando: TA500C07101; **Transpo:** IY126; **Regitar:** VRH2009-106; **Cargo:** 235702

APPLICATION / APLICACIÓN:

HYUNDAI: Santa Fé I 2.4 16V 4x4 2000>2006, Sonata IV 2.0 16V 1998>2005, Trajet 2.0 2000>2008

KIA: Magentis 2.0 2001>2005

ALTERNATOR / ALTERNATOR:

HYUNDAI: 37300-38310, 37300-38700, 37300-38710

MANDO: AB195125, AB195126, AB195141

VALEO: TA000A50701

MANDO
GA431

FEATURES / CARACTERÍSTICAS: 14V, 'A' Circuit

REPLACES / REEMPLAZA:

Transpo: IY510

APPLICATION / APLICACIÓN:

HYUNDAI: H100 Bus/Kasten 2.5 D/TD 1993>2004, Galloper I 2.5 TD intercooler 1991>1998, Porter Kasten 2.5 TD 1994>2004

ALTERNATOR / ALTERNATOR:

MANDO: AD165202, AD165320, AD165320Q, AD165321, AB175051, AR175AA

HYUNDAI: 37300-42017, 37300-42114, 37300-42116, 37300-42200, 37300-32510, 37300-32511

MANDO
GA433

FEATURES / CARACTERÍSTICAS: 14V, 'A' Circuit

REPLACES / REEMPLAZA:

Transpo: IY146; **Regitar:** VRMD08; **Cargo:** 235206

APPLICATION / APLICACIÓN:

HYUNDAI: XG 30/350 1998>2005, Genesis Coupé 3.8 V6 2008

KIA: Opirus 3.5 2003, Sedona V6 3.5 2002>2003

ALTERNATOR / ALTERNATOR:

MANDO: AB112145

KIA: 37300-39600

MANDO
GA908

FEATURES / CARACTERÍSTICAS: 14V, 'A' Circuit

REPLACES / REEMPLAZA:

Mando: TA500C07101; **Transpo:** IY126C; **Regitar:** VR-H2009-89; **Cargo:** 235702

APPLICATION / APLICACIÓN:

HYUNDAI: Santa Fé I 2.4 16V 4x4 2000>2006, Sonata IV 2.0 16V 1998>2005, Trajet 2.0 2000>2008

KIA: Magentis 2.0 2001>2005

ALTERNATOR / ALTERNATOR:

HYUNDAI: 37300-38310, 37300-38700, 37300-38710

MANDO: AB195125, AB195126, AB195141

VALEO: TA000A50701

MITSUBISHI
GA761 // NEW //

FEATURES / CARACTERÍSTICAS: 14V, S. POINT: 14,5V, 'A' Circuit

REPLACES / REEMPLAZA:

Mitsubishi: A866T00870, A866T02270, A866T02970; **Cargo:** 131289; **AS-Poland:** ARE5032; **Transpo:** IM225;

Mobiletron: VR-H2009-3; **Regitar:** VRH2009-3

APPLICATION / APLICACIÓN:

Nissan: Micra L4 1.2 1984>1987

ALTERNATOR / ALTERNATOR:

MITSUBISHI: A001T22971, A002T14472, A002T24371, A002T24971, A002T24972, A002T40971, A002T40972, A003T33772, A003T40672, A005T20972, A005T21871, A005T21897

MITSUBISHI
GA789

FEATURES / CARACTERÍSTICAS: 14V, 'A' Circuit

REPLACES / REEMPLAZA:

Mitsubishi: A866X08971, A866X23972, A866X09871; **Mitsubishi Motors:** ME700799, ME701260; **Regitar:** VRH2009-69; **WAI/**

Transpo: IM294

APPLICATION / APLICACIÓN:

MITSUBISHI: Fuso Trucks (Diesel), Fuso Medium Duty FK L6 6.6L 400cid 6D14-2AT, 6D14-2AT2 1986~1991, FK L6 7.5L 460cid 6D16-1AT4 1992~1995, FM L6 6.6L 400cid 6D14-2AT 1986~1991, FM L6 7.5L 460cid 6D16-1AT2, 6D16-1AT4 1992~1995, Fuso Medium/Heavy Truck FH L6 5.0L 300cid 6D31-0AT 1988~1992, FH L6 5.0L 300cid 6D31-1AT2 1993~1995

ALTERNATOR / ALTERNATOR:

MITSUBISHI: A4T25599, A4T25699, A4T25788, A6T25188; **MITSUBISHI Motors:** ME015164, ME017599, ME077046, ME087651, ME017688, ME077230, ME087563, ME077420, A4T25788, A4T25888, A4T25399, A4T25488, A4T25688, A4T25699, A4T25599

MITSUBISHI
GA144

FEATURES / CARACTERÍSTICAS: 14V, 'A' Circuit (LIN)

REPLACES / REEMPLAZA:

Mitsubishi: 31150-R1A-A01

APPLICATION / APLICACIÓN:

Honda: Civic 2012>, Fit 1.5 16V 2012>, HR-V 2016>

ALTERNATOR / ALTERNATOR:

Honda: A5TJ0191ZC, AHGA81, 31100-R1A-A01;

Mitsubishi: A5TJ0191ZC

RECTIFIER:

GA1344

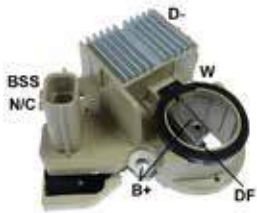
MITSUBISHI
GA194 // NEW //

FEATURES / CARACTERÍSTICAS: 14V, 'A' Circuit

REPLACES / REEMPLAZA:

Mobiletron: VRH2009-164; **AS-Poland:** ARE5119; **Era:** 216191; **Cargo:** 330521

APPLICATION / APLICACIÓN:

RENAULT: Laguna 2.0 2007>2012, W91 K9K 2006

DACIA: Dokker 1.5 2012, Lodgy 1.5 2012>2015, Sandero II 2012>2013

ALTERNATOR / ALTERNATOR:

MITSUBISHI: A004TJ0581, A004TJ0582, A004TJ0281, A004TJ0282, A004TJ0582ZC, A004TJ0582ZE

MITSUBISHI
GA427

FEATURES / CARACTERÍSTICAS: 14V, 'A' Circuit, Terminal L, S e W

REPLACES / REEMPLAZA:

-

APPLICATION / APLICACIÓN:

NISSAN: Sentra 1.6, Tiida 1.6, Livina 1.6/1.8, Frontier 2008-2012, Pathfinder 2.5 DCI

ALTERNATOR / ALTERNATOR:

MITSUBISHI: A2TG0881ZC, A2TG11081ZT, A2TG1081ZT, A3TG2681AE, A003TG2681, A003TG2681AE;

NISSAN: 23100EL010, 23100EB310, 23100EB31A, 23100EB1071A, 23100EB71A

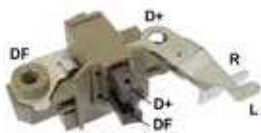
MITSUBISHI
GA428

FEATURES / CARACTERÍSTICAS: 28V, 'A' Circuit

REPLACES / REEMPLAZA:

Mitsubishi: A866T06670; **Transpo:** IM213; **Regitar:** VRH2009-12; **Cargo:** 131517; **AS-Poland:** ARE5062

APPLICATION / APLICACIÓN:

CATERPILLAR: Excavator mitsubishi 4D30

VARIOUS: Chrysler, Hyundai, Mazda, Mitsubishi

ALTERNATOR / ALTERNATOR:

MITSUBISHI: A5T70383, A005T70383

MITSUBISHI
GA471

FEATURES / CARACTERÍSTICAS: 14V, 'A' Circuit

REPLACES / REEMPLAZA:

Mazda: GY01-18-W70;

Mitsubishi: 465, A866X46572

APPLICATION / APLICACIÓN:

MAZDA: 6 L4 2.3L 2260cc 2003-2005;

MAZDA - EUROPA: 6 1800 2002-2008, 6 2000 2002-2008, 6 2300 2002-2008;

MAZDA VAN: MPV V6 2.5L 2497cc 2000-2001

ALTERNATOR / ALTERNATOR:

MAZDA: GY01-18-300E, GY01-18-300H, GY01-18-300J, GY01-18-300R, GY01-18-W9XA, L813-18-300, LF18-18-300, LFY8-18-300R;

MITSUBISHI: A003TG0081, A003TG0081A

MITSUBISHI
GA472

FEATURES / CARACTERÍSTICAS: 14V, 'A' Circuit

REPLACES / REEMPLAZA:

MITSUBISHI: A866X35472; **Regitar:** VRH2009-66; **Cargo:** 138872; **WAI/Transpo:** IM345; **AS Poland:** ARE5019

APPLICATION / APLICACIÓN:

MAZDA: Protege L4 1.5/ 1.6/ 1.8/ 2.0L, 323 1.3/ 1.5/ 1.8L, 626 1.8/ 2.0L, Demio 1.5L, Premacy 1.8/ 2.0L, 3 L4 2.0/ 2.3L, 5 L4 2.3L, RX-8 R2 1.3L

KIA: Sephia L4 1.8L

ALTERNATOR / ALTERNATOR:

MITSUBISHI: A2TB0091, A2TB0191 /B /C, A2TB2391, A3TG1391 /A; **MAZDA:** FP3418300 /A/B /C, LF5018300, Z59918300A, Z5A118300

MITSUBISHI
GA728 // NEW //

FEATURES / CARACTERÍSTICAS: 14V, S. POINT: 14,4V, 'A' Circuit

REPLACES / REEMPLAZA:

Mitsubishi: A866X12682, MD160671; **Mobiletron:** VRH2009-30; **Transpo:** IM282; **Cargo:** 136549; **AS-Poland:** ARE5030

APPLICATION / APLICACIÓN:

MITSUBISHI: Shogun/Pajero/Montero Mk2 2.4 1991>1999, L300 Minibus 2.0/2.4 1986>2004, L300 Flatbed 2.0 1994>2000

ALTERNATOR / ALTERNATOR:

MITSUBISHI: A002T36578, A003T01871, A003T01872, A003T01877, A003T01877A, A003T04177, A003T04178, A003T04199

MITSUBISHI
GA755 // NEW //

FEATURES / CARACTERÍSTICAS: 14V, 'A' Circuit

REPLACES / REEMPLAZA:

Cargo: 234620; **AS-Poland:** ARE5043

APPLICATION / APLICACIÓN:

HYUNDAI: Terracan 2900 2003>2010;

KIA: Sedona 2900 2001>2006

ALTERNATOR / ALTERNATOR:

HYUNDAI / KIA: 37300-4X000, 37300-4X001, 37300-4X002, 37300-4X500, 37300-4X501, 37300-4X502, 37300-4X503;

MANDO: TA000A61201

MITSUBISHI
GA756 // NEW //

FEATURES / CARACTERÍSTICAS: 28V, 'A' Circuit

REPLACES / REEMPLAZA:

Mobiletron: VRH2009-151B; **Cargo:** 237134; **Regitar:** VRH2009-151B

APPLICATION / APLICACIÓN:

Scania Heavy Duty - Europe Medium/Heavy Truck: 114 Series DC11 1996>2004

ALTERNATOR / ALTERNATOR:

MITSUBISHI: A4TR5188, A4TR5191, A4TR5191, A4TR5191ZT;

SCANIA: 1516176, 1525447

MITSUBISHI
GA757 // NEW //

FEATURES / CARACTERÍSTICAS: 14V, 'A' Circuit

REPLACES / REEMPLAZA:

Cargo: 134088; **AS-Poland:** ARE5015; **Transpo:** IM277; **Mobiletron:** VR-H2009-26; **Regitar:** VRH2009-26

APPLICATION / APLICACIÓN:

KIA: Sportage L4 2.0 1995>2002, Sportage 2000 16V 1994>2003;

FORD: Escort L4 1.8 1991;

MAZDA: 323 L4 1.6 1992>1992;

SUBARU: SVX H6 3.3 1992>1997

ALTERNATOR / ALTERNATOR:

KIA: OK011-18-300B, OK011-18-300C, OK011-18-300D, OK011-18-300B, OK011-18-300C, OK011-18-300D; **MAZDA:** B366-18-300G, B61P-18-300, B61P-18-300C, B61P-18-300D, B64J-18-300A, B64J-18-300R, BP02-18-300A, E285-18-300B, F285-18-300B, F285-18-300C, F288-18-300A, F288-18-300B, F288-18-300D, F290-18-300, F290-18-300A, F290-18-300B, F2F8-18-300, F2F8-18-300B, F2F8-18-300C, F2F8-18-300D, N350-18-300, N350-18-300A, N350-18-300B, N350-18-300R, N350-18-300R-00; **SUBARU:** 23700-AA190

MITSUBISHI
GA758 // NEW //

FEATURES / CARACTERÍSTICAS: 14V, 'A' Circuit

REPLACES / REEMPLAZA:

Mitsubishi: A866X17170, A866X17171, A866X17172; **Cargo:** 134026; **AS-Poland:** ARE5033; **Transpo:** IM279; **Mobiletron:** VR-H2009-24; **Regitar:** VRH2009-24

APPLICATION / APLICACIÓN:

MAZDA: 323 1.6/1.8 1990>1991, Protege 1.8 1990>1991, 323 1300 1991>1994, 323 1600 1989>1994, MX5 1600 1990>1998;

FORD: Escort 1.8 1991

ALTERNATOR / ALTERNATOR:

MITSUBISHI: A002T34377, A005T00877, A005T02777; **MAZDA:** B36618300, B36618300C, B36618300E, B36618300R00, BP0218300; **FORD:** FOCZ10346B, FOCZ10346B

MITSUBISHI
GA762 // NEW //

FEATURES / CARACTERÍSTICAS: 14V, 'A' Circuit

REPLACES / REEMPLAZA:
AS-Poland: ARE5136

APPLICATION / APLICACIÓN:
NISSAN: NV400 Bus, NV400 Box;

RENAULT: Fluence 1.6 dCi, Master III Bus;

OPEL: Movano B Bus

ALTERNATOR / ALTERNATOR:
MITSUBISHI: A003TX0481; **NISSAN:** 23100-1822R, 23100-00Q3F; **RENAULT:** 231001822R, 231008137R, 7485121829; **OPEL:** 04420658, 93168346

MITSUBISHI
GA763 // NEW //

FEATURES / CARACTERÍSTICAS: 14V, 'A' Circuit

REPLACES / REEMPLAZA:
Mitsubishi: A822T29570; **Mobiletron:** VR-H2009-85; **Regitar:** VRH2009-85; **AS-Poland:** ARE5115; **Cargo:** 235078

APPLICATION / APLICACIÓN:
CITROËN: Berlingo 2.0 Hdi 4x4 2002>2005, Berlingo 2.0 Hdi 1999>2002, Dispatch 1900 DW8 1999>2001, Dispatch 2000 1999>2006, Relay 2000 2001>2006

PEUGEOT: 206 1900/2000 1998>2005, 306 1900/2000 1999>2002, 406 1800/2000 16V 2000>2002, 607 2200 16V 2000>2005, 806 2000 1999>2002, 806 2000 16V 2000>2002, Partner Combi 1900/2000 2001>2005, Boxer 2000/2200 2002>2010, Expert 1900/2000 1999>2006

ALTERNATOR / ALTERNATOR:
MITSUBISHI: A002TB2291, A003TB0891A; **CITROËN/ PEUGEOT:** 9623727380, 9623727880, 9635772880

MITSUBISHI
GA764 // NEW //

FEATURES / CARACTERÍSTICAS: 14V, 'A' Circuit

REPLACES / REEMPLAZA:
Mobiletron: VR-H2009-49; **Regitar:** VRH2009-49; **AS-Poland:** ARE5012; **Cargo:** 139043; **Transpo:** IM232

APPLICATION / APLICACIÓN:
CITROËN: Xantia 1.9 Turbo 1996>1998, BX 159A 1.9 1984>1986, BX 161A 1.7 1985>1988, BX171A 1.6 1982>1984, Visa 161A 1.7 1984>1991, Visa 180A 1.6 1985>1986

PEUGEOT: 205 1.6 1983>1990, 305 1.6 1982>1990, 305 1.9 1982>1990, 309 1.6 1985>1993, 405 1.6 1987>1992

ALTERNATOR / ALTERNATOR:
MITSUBISHI: A2T13391C, A2T14591, A2T14592, A2T17491, A2T28792, A2T32692, A2T34591, A2T37091A, A2T37691, A2T81891, A2TA2292, A2TA2392, A2TA2492, A2TA2591, A4T00991, A4T00991C, A4T00991D, A4T03392, A4T03492;

CITROËN/ PEUGEOT: 555724, 557024, 570580, 570598, 5705G7, 5705R2, 95619191, 96157360

MITSUBISHI
GA765 // NEW //

FEATURES / CARACTERÍSTICAS: 14V, 'A' Circuit

REPLACES / REEMPLAZA:
Mobiletron: VR-H2009-105SE; **Regitar:** VRH2009-105SE; **Cargo:** 239735; **AS-Poland:** ARE5061; **Transpo:** IM498

APPLICATION / APLICACIÓN:
CITROËN: Berlingo 1.4 2002>2005, C1 1.4 2005>2014, C5 1.8/2.0 16V 2001>2004, C8 2.0/2.2 2002, Xsara break/coupe 1.6 16V 2000>2004, Xsara picasso 1.8 16V 2000>2006

PEUGEOT: 206 1100/1400/1600 1998>2005, 206 1600/1900 2000>2010, 607 2000 16V 2001>2005, Bipper Tepee 1400 2008>2012, Partner Combi 1400 2003>2005, Partner Tepee 1600 16V 2008>2012

ALTERNATOR / ALTERNATOR:
CITROËN/ PEUGEOT: 9633782680, 9638275680, 9638275980, 9641398680, 9642880080, 9649611580, 5705GP, 9640088080, 9656956380

MITSUBISHI
GA767

FEATURES / CARACTERÍSTICAS: 14V, 'A' Circuit

REPLACES / REEMPLAZA:
Cargo: 235541; **AS Poland:** ARE5048; **Mobiletron:** VR-H2009-203; **Regitar:** VRH2009-203

APPLICATION / APLICACIÓN:
MITSUBISHI: Shogun/ Pajero Mk2 2.5 90>99, L200 2.5 96>07, L300 2.5 86>06

ALTERNATOR / ALTERNATOR:
MITSUBISHI: MD366050, A2T82899AT

RECTIFIER:

GA1326

MITSUBISHI

GA768



FEATURES / CARACTERÍSTICAS: S. POINT: 2400Ω, OBS: Capacitor 2,2μF

REPLACES / REEMPLAZA:

APPLICATION / APLICACIÓN:

Dodge: Journey 2.4/2.4 ECO+ 16V Gasoline 09>;

Fiat: Freemont 2.4 16V Gasoline

ALTERNATOR / ALTERNATOR:

MITSUBISHI: A002TX0281ZC, A2TX0281ZC

MITSUBISHI

GA771 // NEW //



FEATURES / CARACTERÍSTICAS: 14V, 'A' Circuit

REPLACES / REEMPLAZA:

Mitsubishi: 5475922304691, A866X54772, A866X68272; **Mobiletron:** VR-H2009-130; **Regitar:** VRH2009-130; **Transpo:** IM547;

AS-Poland: ARE5110

APPLICATION / APLICACIÓN:

NISSAN: 350Z V6 3.5L 2007>2009, 370Z V6 3.7L 2009>2010, 370 Z Roadster 3.7 2009>2010;

INFINITI: EX35 V6 3.5L 2008>2010, FX35 V6 3.5L 2009>2010, G35 V6 3.5L 2007>2008, G37 V6 3.7L 2008>2010, Q50 V6 3.7L 2014>2015, Q70 V6 3.7L 2014>2018

ALTERNATOR / ALTERNATOR:

MITSUBISHI: A002TJ0581, A002TJ0581ZE, A002TJ0591, A002TJ0591ZE, A003TJ0591, A003TJ0691, A003TJ0781, A003TJ1791, A003TJ1791A, A003TJ1791B, A003TJ1791ZC, A003TJ1991, A003TJ1991A, A003TJ3691, A003TJ3691ZC, A2TJ1291ZD;

NISSAN/ INFINITI: 231001AA1A, 23100EG010, 23100JA11A, 23100JA11AR, 23100JK01A, A3TJ1991, A3TJ1791B

MITSUBISHI

GA772



FEATURES / CARACTERÍSTICAS: 14V, 'A' Circuit

REPLACES / REEMPLAZA:

Mitsubishi: A866X47272; **Subaru:** 23815-AA160; **Transpo:** IM472; **Regitar:** VRH2009-109; **Mobiletron:** VR-H2009-109

Cargo: 235897; **AS-Poland:** ARE5106

APPLICATION / APLICACIÓN:

SUBARU: Forester 2.0 1998>2002, 2.0 S Turbo AWD 1998>2001, Impreza Stufenheck 1.6i, 2.0i, Impreza Station Wagon 1.6i, 2.0i 1992>2000, Legacy III 2.0, 2.5 1998>2003, Outback 2.5 1998>2003

ALTERNATOR / ALTERNATOR:

Mitsubishi: A2TB2891, A002TB3091, A002TG0391, A003TB1891, A003TG0491, A003TG0591, A003TG4291

SAAB: 32-01-0646, 32-01-0647

SUBARU: 23700-AA370, 23700-AA380, 23700-AA401, 23700-AA510, 23700-AA520, 23700-AA521, 23700-AA540, 23700-AA541, 23700-AA570

MITSUBISHI

GA774



FEATURES / CARACTERÍSTICAS: 14V, 'A' Circuit. *Rectifier without triode, activated stator. SETPOINT 14,5V

REPLACES / REEMPLAZA:

APPLICATION / APLICACIÓN:

MITSUBISHI: Pajero GLS Turbo montero 2000, Pajero Full, Forklifts;

CHRYSLER: 300 (2001 - 2009)

ALTERNATOR / ALTERNATOR:

MITSUBISHI: A3TB1999, A3TB1999KD, A3TA6098A, A7TA0377, A7TA3377, A007TA3377

MITSUBISHI

GA775



FEATURES / CARACTERÍSTICAS: 14,5V, 'A' Circuit, Terminals S-L

REPLACES / REEMPLAZA:

Hyundai: 37370-47301; **Transpo:** IY702

APPLICATION / APLICACIÓN:

HYUNDAI: H100, Starex (H1) 1997>, H200 Box and Bus 1997>, H1 Flated 2000-2005, Porter 1997-2004

ALTERNATOR / ALTERNATOR:

Hyundai: 37300-42354, 37300-42355, 37300-42356, 37300-42357, 37300-42358; **Mando:** AF111364; **Magneti Marelli:** 063532608010

MITSUBISHI
GA776

FEATURES / CARACTERÍSTICAS: 28,5V, 'A' Circuit, short circuit protection - Brush holder diameter: Ø 24mm

REPLACES / REEMPLAZA:

Mitsubishi: 576, 6100713F; **Magneti Marelli:** RT510259

APPLICATION / APLICACIÓN:

SCANIA: Serie 4, Series P, G, R, T 2004>

ALTERNATOR / ALTERNATOR:

MITSUBISHI: A004TA8191, A4TA8191; **VOLVO:** 20 70 70 50

RECTIFIER:

GA1386

MITSUBISHI
GA777

FEATURES / CARACTERÍSTICAS: 14,5V, 'A' Circuit

REPLACES / REEMPLAZA:

Regitar: VRH2009-112; **Mobiletron:** VR-H2009-112; **Cargo:** 235547; **AS Poland:** ARE5037

APPLICATION / APLICACIÓN:

RENAULT: Mégane 2002-2008 1.5 dCi Alternador, Sandero, Logan, Clio II, Scénic I, Mégane I, Cabriolet I All 1.4/1.6 16V

ALTERNATOR / ALTERNATOR:

MITSUBISHI: AZTB6481 4, A001TA3792; **RENAULT:** 8200660052

MITSUBISHI
GA779

FEATURES / CARACTERÍSTICAS: 14,5V, 'A' Circuit

REPLACES / REEMPLAZA:

Mitsubishi: 23815AA140 ; **Regitar:** VRH2009-107; **Cargo:** 235102; **WAI/Transpo:** IM848

APPLICATION / APLICACIÓN:

Saab: 9-2x h4 2.5L;

SUBARU: Forester H4 2.5L, Impreza H4 2.5L, Legacy H4 2.5L, Outback H4 2.5L, Baja H4 2.5L

ALTERNATOR:

MITSUBISHI: A2TB2891, A2TB2991; **SUBARU:** 23700AA370, 23700AA390.

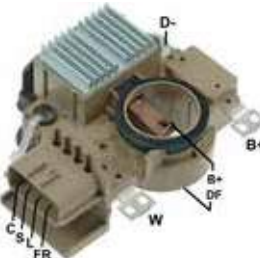
MITSUBISHI
GA780

FEATURES / CARACTERÍSTICAS: 14,5V, 'A' Circuit, Terminals C, S, L, FR. *Uses rectifier without diode trio, stator activated

REPLACES / REEMPLAZA:

Mitsubishi: MD619268, A866X34172; **Regitar:** VRH2009-70; **Cargo:** 138340; **WAI/Transpo:** IM341

APPLICATION / APLICACIÓN:

MITSUBISHI: LS XLS All V6 2007-2008, Dodge Mitsubishi 97-05, L200 Triton, Galant, Pajero Full 2005-2008, Outlander 3.0 ES, Triton 3.2 2008>

ALTERNATOR / ALTERNATOR:

MITSUBISHI: A3TG4491C, A3TG4491ZC, A5TG0379ZT, A2TB0892

MITSUBISHI
GA781

FEATURES / CARACTERÍSTICAS: 14,5V, 'A' Circuit. Active lamp and ignition

REPLACES / REEMPLAZA:

Mitsubishi: A866X28472, MM502585 ; **Regitar:** VRH2009-64M; **Cargo:** 333325; **WAI/Transpo:** IM295

APPLICATION / APLICACIÓN:

NEW HOLLAND: Ford Cub Cadet Compact tractors AG & Industria

ALTERNATOR / ALTERNATOR:

MITSUBISHI: A5TA0991ZC, A5TA3591, ME10997D; **HONDA:** 31100P2EA01, 31100P2EA02, 31100P73A01

MITSUBISHI
GA782

FEATURES / CARACTERÍSTICAS: 14V, 'A' Circuit, Terminals S-L

REPLACES / REEMPLAZA:

Mitsubishi: A866X17072, A866X17082, A866X21072; **Regitar:** VRH2009-33; **Cargo:** 135032; **WAI/Transpo:** IM280

APPLICATION / APLICACIÓN:

FORD

ALTERNATOR / ALTERNATOR:

FORD: F2JY-10346A; **MAZDA:** JF07-18-300, JE28-18-300, JE15-18-300A, JE27-18-300; **MITSUBISHI:** A5T00777, A2T18177, A2T19877, A2T13977, A2T18277, A2T32899, A2T18874, A2T19677, MD150657

MITSUBISHI

GA783



FEATURES / CARACTERÍSTICAS: 14V, 'A' Circuit
REPLACES / REEMPLAZA:
 ...
APPLICATION / APLICACIÓN:
CHRYSLER: PT Cruise, Dodge Nein II 1996>
ALTERNATOR / ALTERNATOR:
MITSUBISHI: A2TB1491, A2TB2791

MITSUBISHI

GA784



FEATURES / CARACTERÍSTICAS: 14V, 'A' Circuit
REPLACES / REEMPLAZA:
GM: 91174657; **Mitsubishi:** A866X42572; **Delco/Ford:** 91174657; **Suzuki:** 3250066D00; **Regitar:** VRH2009-90; **Cargo:** 235279; **WAI/Transpo:** IM381
APPLICATION / APLICACIÓN:
HONDA: Civic 1.6 (1996~2000), Suzuki (1999~2003); **CHEVROLET:** Truck Tracker L4 2.0L 122cid 1999~2003, Tracker L4 2.0L 1995cc 122cid 1999~2003; **SUZUKI:** Truck Vitara L4 2.0L 2000cc 1999~2003
ALTERNATOR / ALTERNATOR:
GM: 30020754, 30021755, 30026055, 30026056, 30027273; **MITSUBISHI:** A5TA3891, A5TA3891A, A5TA4291, A5TA4291ZC; **SUZUKI:** 3140065D00, 3140065D01, 3140066D00, 3140066D01, 3140067D01, 3140065D02; **DELPHI:** RM3763; **LUCAS:** LRA01896

MITSUBISHI

GA785



FEATURES / CARACTERÍSTICAS: 14V, 'A' Circuit
REPLACES / REEMPLAZA:
Mitsubishi: 132, A866X13272, A866X15170, A866X17470, A866X19172, A866X20782, A866X21472, A866X21482; **Nissan:** 2321535F10, 2321564J11, 2321564J12; **Delco/Ford:** E9PZ10316A, F02Z10316B, GRE796, GRE804; **Ford:** E9PZ10316A, F02Z10316B, GRE796, GRE804; **Regitar:** VRH2009-15; **Cargo:** 135030; **WAI/Transpo:** IM284
APPLICATION / APLICACIÓN:
NISSAN: 300ZX Turbo, Bluebird, Stanza
ALTERNATOR / ALTERNATOR:
MITSUBISHI: A002T14694, A002T18792, A2T18792, A003T05192, A2T14694, A2T18792, A3T05192, A002T27594A, A2T27594, A2T27594A, A2T27594T, A002T27594A, A2T02394, A2T02394B, A2T13894, A2T14694, A2T48195, A2T48195A, A2T48195B, A3T00491, A3T00491MA, A3T00896, A3T00896MA, A3T05192, A3T12691, A3T12792; **NISSAN/INFINITI:** 2310015P11, 2310031P10, 2310031P10, 2310031P10R, 2310035F10, 2310052F10, 2310052F11, 2310065E10; **DELPHI:** RM3679, RM3680; **LUCAS:** LRA01757, LRB00340, LRA01529; **VALEO:** VA455; **AC DELCO:** 3341171; **BOSCH:** AL2353N; **DELCO/FORD:** E9DF10300B, E9DZ10300BB, E9DZ10346A

MITSUBISHI

GA786



FEATURES / CARACTERÍSTICAS: 14,5V, 'A' Circuit. Terminals S, C, LI. *Uses rectifier without diode trio, stator activated
REPLACES / REEMPLAZA:
Mitsubishi: A866X50372; **Regitar:** VRH2009-102; **Cargo:** 235843; **WAI/Transpo:** IM503
APPLICATION / APLICACIÓN:
FORD: Fiesta 1.4 Gasoline/ Diesel 2001>, Fusion 1.4 /1.6 Diesel/ Gasoline 2002>
ALTERNATOR / ALTERNATOR:
MITSUBISHI: A5TA7792; **FORD:** 1140139, 2S6T10300DB, 2S6U10300GB

MITSUBISHI

GA787



FEATURES / CARACTERÍSTICAS: 'A' Circuit. Terminals L, IG, S. *Uses rectifier without diode trio, stator activated
REPLACES / REEMPLAZA:
 -
APPLICATION / APLICACIÓN:
IVECO: Stralis 380 /410, Euro Star LD440 1999-2002
ALTERNATOR / ALTERNATOR:
MITSUBISHI: A004TA8492, A004TA0592; **IVECO:** 504028095

MITSUBISHI

GA788



FEATURES / CARACTERÍSTICAS: 14V, 'A' Circuit. Terminals IG, C, L, FR. *Uses rectifier without diode trio, stator activated
REPLACES / REEMPLAZA:
 -
APPLICATION / APLICACIÓN:
HONDA: CRV 2.0 2002-2006, FR 2005>, Stream 2005>, Acura RS-X 2.0L 2002-2006
ALTERNATOR / ALTERNATOR:
MITSUBISHI: A002TC1391ZC, A002TC1391ZE, A2TC1391, A2TC1391ZC, A2TC1391ZE; **HONDA:** 31100PLMA01, 31100PND004, AHGA67

MITSUBISHI
GA423

FEATURES / CARACTERÍSTICAS: 14V, 'A' Circuit

REPLACES / REEMPLAZA:

Mitsubishi: A866T00670, A866T01970, A866T02570, A866T02770, A866T03270, A866T09370, MD607372, MD607570; **Regitar:** VRH2009; **Cargo:** 130835; **WAI/Transpo:** IM204; **AS Poland:** ARE5001

APPLICATION / APLICACIÓN:

MITSUBISHI: L200 1.8, Lancer 1.2, 1.4, Colt 1.2, 1.4T Pajero 2.6 83-86;

MAZDA: 121, 626, 929LRX7, 323;

SUZUKI: SJ710

ALTERNATOR / ALTERNATOR:

MITSUBISHI: A001T23283, A001T24571, A001T32471, A002T16371, A002T40277, A003732877, A1T23377, A2T12371, A2T16371, A2T31677, A3T21278, A3T32772

MITSUBISHI
GA425

FEATURES / CARACTERÍSTICAS: 14V, 'A' Circuit

REPLACES / REEMPLAZA:

Mitsubishi: A866T18270, A866T03070, A866T03470, MD607619, MD618302; **Regitar:** VRH2009-18; **Cargo:** 131290; **WAI/Transpo:** IM205; **AS Poland:** ARE5002

APPLICATION / APLICACIÓN:

MITSUBISHI: L200 2.3D, L200 2.5D 4WD 86-96, Pajero 2.3TD 82-86, Colt 1.8D, Galant 1.8D, Lancer 1.8D, Canter

ALTERNATOR / ALTERNATOR:

MITSUBISHI: A1T32084, A1T32009, A1T32176, A1T33576, A2T01077, A2T07677, A2T07777, A5T15584, A5T15684

MITSUBISHI
GA426

FEATURES / CARACTERÍSTICAS: 14V, 'A' Circuit

REPLACES / REEMPLAZA:

Mitsubishi: A866X498; **Regitar:** VRH2009-105; **Cargo:** 235450; **WAI/Transpo:** IM498; **AS Poland:** ARE5038

APPLICATION / APLICACIÓN:

CITROËN: C4 1400 16V 2004-2010; C4 1600 16V 2004-2010; C4 2000 16V 2004-2010; C5 1800 16V 2001-2010; C5 2000 16V 2001-2004; C8 2000 16V 2002-2010; C8 2200 16V 2002-2010; Xsara Picasso 1800 16V 2000-2010;

CITROËN VAN: Berlingo - LCV 1400 2008-2012; Berlingo - LCV 1600 16V 2008-2012;

CITROËN LCV VAN: Berlingo 1600 16V 2008-2012;

PEUGEOT: 207 1400 16V KFU 2006-2010; 207 1600 16V, NUF 2006-2010; 307 2000 16V 2001-2010; 407 2200 16V 2004-2010; 607 2200 16V 2000-2005; 807 2000 16V 2002-2005, 807 2200 16V 2002-2010;

PEUGEOT VAN: Partner Tepee 1600 16V 2008-2012;

ALTERNATOR / ALTERNATOR:

MITSUBISHI: A5TA6292, A5TA6391, A5TA6291, A2TA6392C, 9640088080, A003TB2691

RECTIFIER:

GA1396 / GA1335

MITSUBISHI
GA430

FEATURES / CARACTERÍSTICAS: 14V, 'A' Circuit

REPLACES / REEMPLAZA:

Mitsubishi: A866X22472, A866X23072; **Nissan/ Infiniti:** 23215-64J13, 23215-OP611; **Cargo:** 137182; **AS-Poland:** ARE5034;

Mobiletron: VR-H2009-45; **Regitar:** VRH2009-45; **Transpo:** IM292

APPLICATION / APLICACIÓN:

INFINITI: J30 V6 3.0L 1993>1996;

NISSAN: 300ZX V6 3.0L VIN/ TURB 1996, 300ZX V6 3.0L Turb 1994>1995

ALTERNATOR / ALTERNATOR:

Mitsubishi: A002T33593, A002T33593A

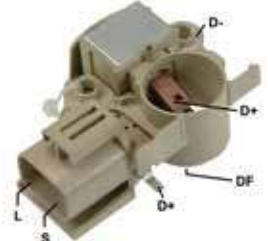
MITSUBISHI
GA470

FEATURES / CARACTERÍSTICAS: 14V, 'A' Circuit, Terminals S-L

REPLACES / REEMPLAZA:

Mitsubishi: A866X03470, A866X06471, A866X08070, A866X08071; **Hitachi:** 2321517B10, 2331308515; **Lucas:** 21513126, UCJ233;

Regitar: VRH2009-8; **Cargo:** 132102; **WAI/Transpo:** IM263; **AS Poland:** ARE5026

APPLICATION / APLICACIÓN:

NISSAN

ALTERNATOR / ALTERNATOR:

MITSUBISHI: A2T47794; **NISSAN:** 23100-51S10

MITSUBISHI
GA790

FEATURES / CARACTERÍSTICAS: 14V, 'A' Circuit, Terminals: DF, L

REPLACES / REEMPLAZA:

Mitsubishi: A5TA2591, A005TA2591, A002T82091, A2T82091; **Ford:** 97MF10300AA/AB

APPLICATION / APLICACIÓN:

FORD: FIESTA 1.2 1995-2002, FIESTA 1.4 1998, FOCUS 1.4/1.6 1999, PUMA 1.7, WITH MITSUBISHI 12V ALTERNATOR

ALTERNATOR / ALTERNATOR:

A5TA2591, A005TA2591, A002T82091, A2T82091; **FORD:** 97MF10300AA/AB

MITSUBISHI
GA791

FEATURES / CARACTERÍSTICAS: 28V, 'A' Circuit - Door brush diameter: Ø 27,8mm

REPLACES / REEMPLAZA:

WAI/Transpo: IM691

APPLICATION / APLICACIÓN:

SCANIA: Series P, G, R, T

ALTERNATOR / ALTERNATOR:

MITSUBISHI: A004TR5691, A4TR5691, A004TR5491; **SCANIA:** 1 777 299, 1 884 268

RECTIFIER / RECTIFICADOR:

GA1342

MITSUBISHI
GA792

FEATURES / CARACTERÍSTICAS: 14V, 'A' Circuit

REPLACES / REEMPLAZA:

Mitsubishi: A866X13272, A866X15170, A866X17470, A866X19172; **Nissan:** 2321535F10, 2321564J11, 2321564J12;

Regitar: VRH2009-15; **Cargo:** 135030; **WAI/Transpo:** IM284

APPLICATION / APLICACIÓN:

Nissan: 300 ZX V6 3.0L, 200 SX 1.8L, Silvia 1.8L, Stanza L4 2.4L

ALTERNATOR / ALTERNATOR:

FORD: F2JY-10346A; **MAZDA:** JF07-18-300, JE28-18-300, JE15-18-300A, JE27-18-300; **MITSUBISHI:** A2T18874, A2T19677,

A5T00777, A2T18177, A2T19877, A2T13977, A2T18277, A2T32899; **MITSUBISHI Motors:** MD150657;

MITSUBISHI
GA793

FEATURES / CARACTERÍSTICAS: 14V, 'A' Circuit

REPLACES / REEMPLAZA:

Mitsubishi: A2T2094B

APPLICATION / APLICACIÓN:

..

ALTERNATOR / ALTERNATOR:

MITSUBISHI: A2TA2094, A2TA1994, A2TA0592, A2TA1981, A2TA0591, A2TA2094B, A2TA2091;

MITSUBISHI
GA794

FEATURES / CARACTERÍSTICAS: 28V, 'A' Circuit

REPLACES / REEMPLAZA:

Mitsubishi: A 866 X 26070; A 866 X 26072; ME701302; **Regitar:** VRH2009-77; **Cargo:** 333354; **WAI/Transpo:** IM843

APPLICATION / APLICACIÓN:

MITSUBISHI: Industrial Applications Mitsubishi, Fuso Trucks

ALTERNATOR / ALTERNATOR:

MITSUBISHI: A004T40286, A004T40289, A004T40386, A004T40389, A004T70086, A004T70099, A004T70189, A004T95099, A004TU3088, A004TU3186, A4T40286, A4T40289, A4T40386, A4T40389, A4T70078, A4T70086, A4T70099, A4T70186, A4T70189, A4TU3085, A4TU3088, A4TU3186, A4TU3586, A9TU3099, A9TU3199, ME011886, ME017632, ME077788, ME077789, ME077790, ME077869, ME092899, ME093245, ME093246, ME093256, ME151217, ME151974, ME160917, ME160918, ME163230

MITSUBISHI
GA795

FEATURES / CARACTERÍSTICAS: 14V, 'A' Circuit

REPLACES / REEMPLAZA:

Mitsubishi: A 866 X 40371; **Regitar:** VRH2009-82; **Cargo:** 230985; **WAI/Transpo:** IM757

APPLICATION / APLICACIÓN:

FORD: Transit LCV

LAYLAND DAF VANS: Convoy 2.5L Ford Engine

ALTERNATOR / ALTERNATOR:

MITSUBISHI: A3TN1791; **FORD:** 98VB10K359BB

MITSUBISHI
GA796

FEATURES / CARACTERÍSTICAS: 14V, 'A' Circuit

REPLACES / REEMPLAZA:

Mitsubishi: A866X26172; **Mazda:** S5SN18W70; **Regitar:** VRH2009-63; **Cargo:** 138309; **WAI/Transpo:** IM290

APPLICATION / APLICACIÓN:

Hyster Lift truck: Various Models Mazda FE Engine;

Sumitomo Yale Lift Truck: DB FE Engine, DB HA Engine;

Yael Lift Truck: Various Models FE Engine, Various Models HA Engine, Various Models XA Engine

ALTERNATOR / ALTERNATOR:

FORD: F3XA-10300AC; **MITSUBISHI:** A3T12991, A2T38391, A2T38491, A2T39992, A2T35092, A2T38291, A3TA0791, A2T34991, A2T34992, A2T38891, A3T11591, A3T13191, A2T36392, A2T34892, A2T36391, A3T13091, A2T35091, A3T13291, A2T38892;

MITSUBISHI Motors: MD198648, MD194466, MD198649, MD189659, MD191402, MD184281, MD196858, MD190812, MD177244, MD196857, MD189658, MD190819, MD184279, MD175810, MD175811, MD184280, MD191578, MD184278; **NISSAN:** 23100-OB00

MITSUBISHI
GA797

FEATURES / CARACTERÍSTICAS: 14V, 'A' Circuit

REPLACES / REEMPLAZA:

Mitsubishi: A866X25572, MD618735, MD619167, A866X24472, A866X24972, RGF1-18-W70; **Regitar:** VRH2009-67; **Cargo:** 137075;

WAI/Transpo: IM847; **Magneti Marelli:** RT510189; **Mobiletron:** VR-H2009-67

APPLICATION / APLICACIÓN:

MITSUBISHI: Fuso Canter, Delica, L300, Montero

ALTERNATOR / ALTERNATOR:

MITSUBISHI: A2T37976, A2TN0076, A2TN0199, A2TN0299, A2TN0399, A2TN0499, A2TN0599, A3T11678, A3TN0078, A3TN0199, A3TN0299, A3TN0399, A3TN0499, A3TN0699, A3TN15099, MD192135, MD30984, MD309844; **UNIPOINT:** ALT-V018

RECTIFIER:

GA1387

MITSUBISHI
GA798

FEATURES / CARACTERÍSTICAS: 14V, 'A' Circuit

REPLACES / REEMPLAZA:

Mitsubishi: A866X14072, A866X14070; **Ford:** E8PZ10313A, E8PZ10316A, GRE792; **Motorcraft:** GRE317; **Regitar:** VRH2009-11;

WAI/Transpo: IM270

APPLICATION / APLICACIÓN:

FORD: Thunderbird

ALTERNATOR / ALTERNATOR:

MITSUBISHI: A3T01496, A3T01496MA; **FORD:** E8SF10300AA, E8SZ10346A; **LESTER:** 13189; **MOTORCRAFT:** GLE254;

PIC: 203325

MITSUBISHI
GA799

FEATURES / CARACTERÍSTICAS: 28V, 'A' Circuit

REPLACES / REEMPLAZA:

Mitsubishi: A866T06870, ME700635; **Regitar:** VRH2009-47; **Cargo:** 137396; **WAI/Transpo:** IM212

APPLICATION / APLICACIÓN:

MITSUBISHI: Canter FE431, Canter FE444, Trucks, Mitsubishi Fuso in USA

ALTERNATOR / ALTERNATOR:

MITSUBISHI: 34468-25100, A2T72483, A2T72986, A2T72987, A2T72999, A2T73387, ME049175, ME049177, ME070120, ME087508

MITSUBISHI
GA800

FEATURES / CARACTERÍSTICAS: 14V, 'A' Circuit, R-L

REPLACES / REEMPLAZA:

Mitsubishi: A866X04872, A866X05471, A866X05472; **Regitar:** VRH2009-4; **Cargo:** 131524; **WAI/Transpo:** IM216

APPLICATION / APLICACIÓN:

CHRYSLER; HYUNDAI; MAZDA; MITSUBISHI; ASIA: Townner; **DODGE; FORD;**

ALTERNATOR / ALTERNATOR:

MITSUBISHI: A001T33474, A001T33874, A001T34472, A001T34572, A001T34672, A001T40391, A001T40491, A001T40791, A001T40891

MITSUBISHI
GA801

FEATURES / CARACTERÍSTICAS: 14V, 'A' Circuit, Terminals: S-L.

REPLACES / REEMPLAZA:

Mitsubishi: A2T34892, A2T35092, A2T38892, A2T40092, A2TA2871, A3T12291, A3T12391, A3T12491, A 866 X 22272, A 866 X 23182, A 866 X 25472, MD618569, MD618696; **Regitar:** VRH2009-37; **Cargo:** 136649; **WAI/Transpo:** IM832; **Mobiletron:** VR-H2009-37; **Magneti Marelli:** RT510192

APPLICATION / APLICACIÓN:

FORD; MITSUBISHI; NISSAN; HYSTER: Forklifts XM, GLP, GTP, GP

ALTERNATOR / ALTERNATOR:

MITSUBISHI: A002T34892, A002T34991, A002T34992, A002T35091, A002T36391, A002T36392, A002T38291, A002T38391, A002T38491, A002T38891, A002T38892, A002T39991, A002T39992, A002T40092, A002T80591, A002TA0991, A002TA3491, A003T11591, A003T12991, A003T13091, A003T13191, A003T13291, A003T14491, A003TA0791, A003TA1191, A003TA1391, A005T05091, A005T07592, A2T34991, A2T34992, A2T35091, A2T36391, A2T36392, A2T38291, A2T38391, A2T38491, A2T38891, A2T38892, A2T80591, A2T80591ZC, A2T81791, A3T11591, A3T12491, A3T12991, A3T13091.

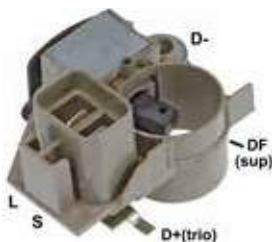
MITSUBISHI
GA802

FEATURES / CARACTERÍSTICAS: 14V, 'A' Circuit

REPLACES / REEMPLAZA:

Mitsubishi: A 866 X 05270, A 866 X 05272, A 866 X 09071, A 866 X 09072, A 866 X 09771, A 866 X 09782, A 866 X 12472, MD611432, MD611565, MD611588, MD611710, MD618483; **Regitar:** VRH2009-6; **Cargo:** 131523; **WAI/Transpo:** IM217

APPLICATION / APLICACIÓN:

MITSUBISHI: L200 1.8b/ 2.0/ 2.4/ 2.6, Pajero 2.4b/ 2.6b, Starion 2.0 EX Turbo, L300 2.0/ 2.0 4X4/ 2.4 4X4, Colt 1.3i/ 1.5i, Galant 2.0/ 2.4, Lancer 1.2/ 1.3/ 1.5, Sapporo 2.4i, Space Wagon 1.8;

NISSAN;

DODGE;

ALTERNATOR / ALTERNATOR:

MITSUBISHI: A2T02271, A2T02471, A2T03, A2T477, A2T03972, A2T04271, A2T06871, A2T07292, A2T07292A, A2T09392, A2T09493, A2T09691, A2T09792, A2T09792ZC, A2T14792, A2T14972, A2T17692, A2T48176, A2T48176A, A2T48176B, A2T48195, A2T48195A, A2T18195B, A2T48691, A2T48791, A2T49972, A2T49977, A2T49992, A3T00692, A3T00792, A3T02193, A3T02198, A3T03392, A3T03393, A3T03471, A3T03492, A3T03493, A3T03493ZC, A3T04292, A3T04493, A3T08293, A3T41876, A3T45693, A3T45694, A5T41094B, MD102084, MD102085, MD102088, MD105339, MD106713, MD108230, MD108509, MD108809, MD110318, MD111148, MD111233, MD112322, MD112323, MD114620, MD116418, MD116427, MD117156, MD125096, MD125569, MD126796, MD133171, MD134315, MD136838, MD136839, MD140247, MD141855, MD149750, MD153843, MD166174, MD169683, MD169683D

RECTIFIER:

GA1391

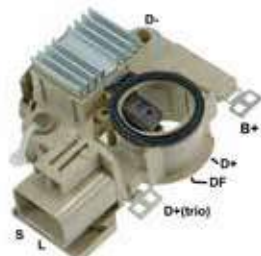
MITSUBISHI
GA803

FEATURES / CARACTERÍSTICAS: 14V, 'A' Circuit

REPLACES / REEMPLAZA:

Mitsubishi: A866X20472, A866X20572, A866X20972, A866X22772, A866X24072, A866X27772; **Regitar:** VRH2009-22; **Cargo:** 135233; **WAI/Transpo:** IM830

APPLICATION / APLICACIÓN:

MAZDA: 626 1.8i/ 2.0, MX6 2.0i, 323 1.3 8V/16V, 323 1.8i, GT, 323 1.8i, turbo, MX3 1.6i, MX5 1.5i;

FORD: Probe, Thunderbird;

KIA: Sephia

ALTERNATOR / ALTERNATOR:

MITSUBISHI: A2T33191, A2T33891, A2T33991, A2T35177, A2T39091, A2T39391, A2TA3991, A2TA5891, A3T07592, A3T08491, A3T08491ZC, A3T08591, A5T03391

MITSUBISHI
GA804

FEATURES / CARACTERÍSTICAS: 14V, 'A' Circuit

REPLACES / REEMPLAZA:

Mitsubishi: A866T09780, A866T09782, VR425; **Regitar:** VRH2009-78; **Cargo:** 131523, 234229; **WAI/Transpo:** IM831

APPLICATION / APLICACIÓN:

HYUNDAI: Elantra, Mando Marine, Atos;

MITSUBISHI: Eclipse, Sonata

ALTERNATOR / ALTERNATOR:

HYUNDAI: 37300-33010, 37300-33013, 37300-33030, 37300-33100, 37300-33101, 37300-33103, 37300-33110;

LESTER (OLD): 13516, 13517, 13518; **MANDO:** AB160108

MITSUBISHI
GA805

FEATURES / CARACTERÍSTICAS: 14V, 'A' Circuit

REPLACES / REEMPLAZA:

Mitsubishi: A866X12770, A866X12772, A866X12780, A866X12782, A866X12980, A866X27472, A866X29272, B67518W70; **Regitar:** VRH2009-7; **Cargo:** 132101; **WAI/Transpo:** IM265

APPLICATION / APLICACIÓN:

MAZDA: 323 1.3, 1.5, 1.6, 626 2.0i 16V, 626 2.0i 16V stationcar, 626 2.2i, 626 2.2i stationcar;

FORD: Tracer, Probe 2.2 turbo intercooler

ALTERNATOR / ALTERNATOR:

MITSUBISHI: A2T05772, A2T05892, A2T05893, A2T05893ZC; **LESTER:** 13183

MITSUBISHI
GA806

FEATURES / CARACTERÍSTICAS: 14V, 'A' Circuit

REPLACES / REEMPLAZA:
Mitsubishi: MD618957, A866X28572; **Regitar:** VRH2009-73; **Cargo:** 234313; **WAI/Transpo:** IM845

APPLICATION / APLICACIÓN:
MITSUBISHI: Eclipse, Eagle Talon

ALTERNATOR / ALTERNATOR:
MITSUBISHI: A2T82791, A2T82791ZC, A2T82792, A2T82792ZC, A2TA0891, A2TA0892, A2TA0892ZC, A2TA5393ZC, A2TA5394, A5TA0291, MD310997, MD313392, MD314373, MD327513, MD327535, MD354784, MD357737, MD363639; **LESTER:** 13691, 13693

RECTIFIER:

GA1394 / GA1388

MITSUBISHI
GA807

FEATURES / CARACTERÍSTICAS: 14V, 'A' Circuit. SETPOINT 14,5V

REPLACES / REEMPLAZA:
Mitsubishi: A866X13970, A866X28572; **Regitar:** VRH2009-10N; **WAI/Transpo:** IM268

APPLICATION / APLICACIÓN:
MITSUBISHI: Tempo, Mercury, Topaz

ALTERNATOR / ALTERNATOR:
MITSUBISHI: A3T01596, A3T01596MA, A3T01598, A3T01598MA, A3T10598, E3T0598, E3T01596MA; **FORD:** E83F-1300-AA, E83F-10300-AB, E83F-10300-BA, E83Z-10346-A, E83Z-10346-BRM, E8DF-10300-AB, E8DF-10300-BA, E8DZ-10346-A, F73J-10346-AA, GLE-250, GLE-251, GLE-439

RECTIFIER:

GA1373

MITSUBISHI
GA808

FEATURES / CARACTERÍSTICAS: 28V, 'A' Circuit

REPLACES / REEMPLAZA:
Mitsubishi: A866X28372, ME701399; **Regitar:** VRH2009-80B; **Cargo:** 234304; **WAI/Transpo:** IM846

APPLICATION / APLICACIÓN:
MITSUBISHI: Fuso Canter

ALTERNATOR / ALTERNATOR:
MITSUBISHI: A3T75883, A3TN5188, A3TN5288, ME017615

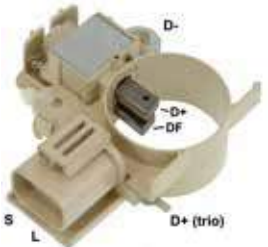
MITSUBISHI
GA809

FEATURES / CARACTERÍSTICAS: 14V, 'A' Circuit

REPLACES / REEMPLAZA:
Mitsubishi: A866X09171, A866X09170, MD611481; **Regitar:** VRH2009-28; **Cargo:** 131471; **WAI/Transpo:** IM281; **Magneti Marelli:** RT510197

APPLICATION / APLICACIÓN:
MITSUBISHI: Pajero 2500 Diesel, Delica 2300 Van Diesel, Mirage 1800 Diesel, Galant 1800 Diesel, Sava 1800 Diesel, Shariot 1800 Diesel.

ALTERNATOR / ALTERNATOR:
MITSUBISHI: A3T75883, A3TN5188, A3TN5288, ME017614

MITSUBISHI
GA815

FEATURES / CARACTERÍSTICAS: 14V

REPLACES / REEMPLAZA:
Mitsubishi: 3188414R; **Regitar:** VRH2009-62; **Cargo:** 234541; **WAI/Transpo:** IM318

APPLICATION / APLICACIÓN:
HONDA: Civic

ALTERNATOR / ALTERNATOR:
HONDA: 31100-P2F-CO1, 31100-P2F-CO2, AHGA27, AHGA39

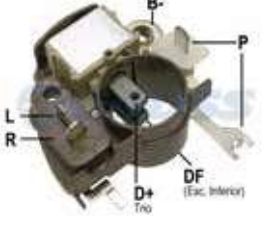
MITSUBISHI
GA825

FEATURES / CARACTERÍSTICAS: 14V, 'A' Circuit, Terminals: B+, DF, L, P, R, B-

REPLACES / REEMPLAZA:
Delco/Ford: E7GZ10316A, F0BZ10316A; **Fiat/Marelli:** 940038086; **Ford:** E7GZ10316A, F0BZ10316A, GRE788; **Lucas:** 21513133; **Mazda:** BF1462, FE6518W70, FE8518W70; **Mitsubishi:** A866X07570; **Motorcraft:** GRE800;

APPLICATION / APLICACIÓN:
MAZDA: 323 1987>, B2000, WITH MITSUBISHI 12V ALTERNATORS

ALTERNATOR / ALTERNATOR:
MITSUBISHI: A2T04677, A5T16471, A5T30977, A5T31177, A5T31671, A5T31971, A5T31971A, A5T32571; **FORD:** E8BZ-10346B, F0CZ-10346B, F0BZ-10346A, E8BZ-10346A, E7GZ-10346A; **MAZDA:** F651-18-300B, B101-18-300, B603-18-300, B603-18-300A, FE85-18-300, B10-18-300A;

MITSUBISHI
GA835

FEATURES / CARACTERÍSTICAS: 14V, 'A' Circuit, Terminals: D, IG, L

REPLACES / REEMPLAZA:

Honda: 04314P08014, 31150PM50040; **Mitsubishi:** A866T38570, A866X13670, A866X13671, A866X22072, A866X22081; **Cargo:** 135064

APPLICATION / APLICACIÓN:

HONDA: CIVIC, CRX, WITH MITSUBISHI 12V ALTERNATOR

ALTERNATOR / ALTERNATOR:

MITSUBISHI: A1T02291, A1T02292, A1T02292ZC, A1T04891, A1T04892;

MITSUBISHI
GA836

FEATURES / CARACTERÍSTICAS: 14V, 'A' Circuit, Terminals: D, IG, L

REPLACES / REEMPLAZA:

Delco/Ford: 96059547; **Mitsubishi:** A866X23772, A866X23773; **Cargo:** 139667;

APPLICATION / APLICACIÓN:

SUZUKI: SWIFT 1.3, VITARA 1995>, SIDERICK 16V 1996>, WITH MITSUBISHI 12V ALTERNATOR

ALTERNATOR / ALTERNATOR:

MITSUBISHI: A5T07091ZC, A5T07092ZC, A7T00191, A7T01874, A7T02471;

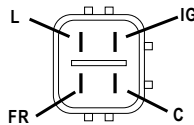
MITSUBISHI
GA837

FEATURES / CARACTERÍSTICAS: 14V, 'A' Circuit

REPLACES / REEMPLAZA:

Mitsubishi: A866X48782; **Regitar:** VRH2009-94; **Cargo:** 235278; **WAI/Transpo:** IM851

APPLICATION / APLICACIÓN:

HONDA: Civic 1.7 2001-2004

ALTERNATOR / ALTERNATOR:

MITSUBISHI: A5TA7091, A2TB7591; **HONDA:** 31100PLMA01

RECTIFIER:

GA1383

MITSUBISHI
GA838

FEATURES / CARACTERÍSTICAS: 14V, 'A' Circuit, Terminals: C, FR, IG, L

REPLACES / REEMPLAZA:

Cargo: 230260; **Honda:** 31150P2EA01;

APPLICATION / APLICACIÓN:

HONDA: CIVIC, CIVIC DEL SOL, WITH MITSUBISHI 12V ALTERNATOR

ALTERNATOR / ALTERNATOR:

MITSUBISHI: A5TA0991, A5TA0991ZC, ME10997D;

MITSUBISHI
GA848

FEATURES / CARACTERÍSTICAS: 14V, 'A' Circuit

REPLACES / REEMPLAZA:

Mitsubishi: A866X08470, A866X08471, A866X08472, A866X12071, A866X8472; **Nissan:** 23125-58S10, 23215-58S10; **Cargo:** 132936; **Huco:** 132919; **Regitar:** VRH2009-23; **WAI/Transpo:** IM274

APPLICATION / APLICACIÓN:

NISSAN: (1986-88) Nissan

ALTERNATOR / ALTERNATOR:

MITSUBISHI: A5T41592B, A5R41592, A5T41592; **NISSAN:** 23100-53A11, 23100-53A10;

MITSUBISHI
GA849

FEATURES / CARACTERÍSTICAS: 14V, 'A' Circuit

REPLACES / REEMPLAZA:

Honda: 04314-P08-014; **Mitsubishi:** 220, A866T38570, A866X22081; **Regitar:** VRH2009-40; **Cargo:** 135064; **WAI/Transpo:** IM839

APPLICATION / APLICACIÓN:

HONDA: (1992-95) Honda

ALTERNATOR / ALTERNATOR:

HONDA: 31100-008-014; **MITSUBISHI:** A5T04092;

MITSUBISHI
GA856

FEATURES / CARACTERÍSTICAS: 14V, 'A' Circuit

REPLACES / REEMPLAZA:

Mitsubishi: A866X37272, A866X47672, 476; **Nissan:** 23215AG010; **Regitar:** VRH2009-99; **Cargo:** 231510; **WAI/Transpo:** IM476; **Mobiletron:** VR-H2009-99

APPLICATION / APLICACIÓN:

GM: Omega Australiano 3.8 V6; **KIA:** Sephia

ALTERNATOR / ALTERNATOR:

MITSUBISHI: A003TB0191, A3TA8291, A3TB0191, A3TA8291RR

MITSUBISHI
GA857

FEATURES / CARACTERÍSTICAS: 14V, 'A' Circuit

REPLACES / REEMPLAZA:

Mitsubishi: A866X27572, ME70136, ME701363; **Regitar:** VRH2009-79; **Cargo:** 139110; **WAI/Transpo:** IM854

APPLICATION / APLICACIÓN:

MITSUBISHI: Pajero 2.8D 94-98, Canter;

NISSAN: King Van;

Obs: application with GA1398 (alternator with Trio Diode)

ALTERNATOR / ALTERNATOR:

MITSUBISHI: A2TA3098, A3TA3098, A3TA6098, A3TO9199, A3TO9698, A3TO9699, A3TO9799

RECTIFIER:

GA1398 / GA1399

MITSUBISHI
GA858

FEATURES / CARACTERÍSTICAS: 14V, 'A' Circuit. Terminals S, L. *Uses rectifier without diode trio, stator activated

REPLACES / REEMPLAZA:

Bowers: BAO3249; **Kubota:** 3M760-64010, 3M760-64011; **Mitsubishi:** MD350608, **Nissan:** 23100-7B000

APPLICATION / APLICACIÓN:

NISSAN: 99/2002;

MITSUBISHI: Pajero3.0, Montero Sport 3.0 3,5L 1998-2004

ALTERNATOR / ALTERNATOR:

MITSUBISHI: A3TA0791A, MD330608, MD313395, MD350608, A003TA0791

MITSUBISHI
GA867

FEATURES / CARACTERÍSTICAS: A-Circuit; Terminals B+, DF, IG, L, W, B-, C, DFM

REPLACES / REEMPLAZA:

Mobiletron: VRH2009-139; **Transpo:** IM569; **Mitsubishi:** 6050921F; **Honda:** 31150-RB0-004

APPLICATION / APLICACIÓN:

HONDA: New Fit 1.3/1.5 2008>, City 1.3/1.5 2009>

ALTERNATOR / ALTERNATOR:

MITSUBISHI: A5TJ0091ZD, AHGA77; **HONDA:** 31100RB0004, 31100RB00041, 31100RB0A0243

MITSUBISHI
GA868

FEATURES / CARACTERÍSTICAS: 14V, 'A' Circuit | SETPOINT 14,5V

REPLACES / REEMPLAZA:

Transpo: IM853HD; **Mobiletron:** VR-H2009-152; **AS-Poland:** ARE5113

APPLICATION / APLICACIÓN:

Honda: Civic L4 1.6L 1999>, HR-V (GH) 1.6 16V (4WD), Logo 1.3

ALTERNATOR / ALTERNATOR:

Mitsubishi: A5TA4591, A5TB0291ZT; **Honda:** AHGA58

RECTIFIER:

GA1343

MITSUBISHI
GA871

FEATURES / CARACTERÍSTICAS: 14V, "A" Circuit, Terminals LI, RC, S. SETPOINT 14,2V

REPLACES / REEMPLAZA:

Mitsubishi: A866T52970;

WAI/Transpo: IM529; **Regitar:** VRH2009-98

APPLICATION / APLICACIÓN:

FORD: Fusion 2.3 2005>, Edge 2008>

ALTERNATOR / ALTERNATOR:

Mitsubishi: A4TJ0181, A4TJ0182, A003TJ0891ZC, 4W7Z10346AC, 6E5T10300AD, 6E5Z10346AA, 6W7Z10346AA, 7E5T10300AA, 7E5T10300AB

RECTIFIER:

GA1359

MITSUBISHI

GA874



FEATURES / CARACTERÍSTICAS: 28V, 'A' Circuit
REPLACES / REEMPLAZA:
 ...
APPLICATION / APLICACIÓN:
VOLVO: VM 210, 240, 260
ALTERNATOR / ALTERNATOR:
MITSUBISHI: A002TA8891; **VOLVO:** 20498749
RECTIFIER:
 GA1340

MITSUBISHI

GA877



FEATURES / CARACTERÍSTICAS: 14V, 'A' Circuit
REPLACES / REEMPLAZA:
Mitsubishi: 5648111D; **Regitar:** VRH2009-148; **Cargo:** 235836; **WAI/Transpo:** IM564
APPLICATION / APLICACIÓN:
Nissan: Sentra 2007>2010, Versa 2007>2011, NV200 2013>2014, Qashqai 2007>2014, X-Trail 2007>2009
ALTERNATOR / ALTERNATOR:
Nissan: A2TJ0281ZC

MITSUBISHI

GA878

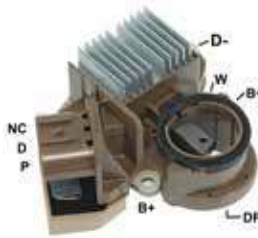

FEATURES / CARACTERÍSTICAS: 14V, 'A' Circuit
REPLACES / REEMPLAZA:
Mitsubishi: A866X50572; **Regitar:** VRH2009-114; **Cargo:** 331633; **WAI/Transpo:** IM505
APPLICATION / APLICACIÓN:
MAZDA: 6 L4 2.3L 2260cc 2008, 6 L4 2.3L 2260cc wo/Turbo 2006~2007, 6 L4 2.3L 2260cc 138cid 2008, 6 L4 2.3L 2260cc 138cid wo/Turbo 2006~2007, 6 L4 2.5L 2488cc 152cid 2009, MX-5 Miata L4 2.0L 2000cc 122cid 2006~2008, 6 1800 2008~2012, 6 2000 2008~2012, MX5 Mk3 2000, 16V 2005-2008, Van MPV V6 3.0L 183cid 2002~2006
ALTERNATOR / ALTERNATOR:
MAZDA: AJ5118300, AJ5118300A, AJ5118300R, AJ5718300, AJ5718300A, AJ5718300B, L33G18300, L33G18300A, L33G18300R00, L33G18300R0A, L3M618300A, L3M618300B, L3M618300C, L3M618300R0A, L3P918300A, L3P918300B, L3P918300C, L3P918300R, L3P918300R0C, LFB618300; **MITSUBISHI:** A3TJ0191, A3TJ0291, A2TJ0391, A2TJ0391A, A2TJ0391B, A2TJ0391C

MITSUBISHI

GA887



FEATURES / CARACTERÍSTICAS: 14V, 'A' Circuit
REPLACES / REEMPLAZA:
Mitsubishi: A866X11870, A866X11872; **Cargo:** 135033; **AS-Poland:** ARE5093; **Mobiletron:** VR-H2009-14N;
Regitar: VRH2009-14; **Transpo:** IM275
APPLICATION / APLICACIÓN:
HONDA: Civic V Hatchback 1.5i/ 1.6i 16V 1991>1995, Civic V Stufenheck 1.5i/ 1.6 16V Vtec 1991>1995, Civic V Coupé 1.5i/ 1.6i 1993>1996, Civic VI Stufenheck 1.6i Vtec 1995>2001, Civic VI Coupé 1.6 i Vtec 1996>2000, Civic VI Aerodeck 1.8 16V 1998>2001, CRX III 1.6 ESI 1992>1998
ALTERNATOR / ALTERNATOR:
Mitsubishi: A5T04292, A1T03191, A7T02491

MITSUBISHI

GA888



FEATURES / CARACTERÍSTICAS: 14V, 'A' Circuit
REPLACES / REEMPLAZA:
Mitsubishi: A866X26641, A866X26682; **Transpo:** IM835; **Regitar:** VRH2009-50; **Mobiletron:** VR-H2009-50; **Cargo:** 138296
APPLICATION / APLICACIÓN:
HONDA: Civic V Hatchback 1.5, 1.6 1991>1995, Stufenheck 1.5/ 1.6 1991>1995, Coupe 1.5/ 1.6 1993>1996, Civic VI Stufenheck 1.6i Vtec 1995>2001, Coupe 1.6 i Vtec 1996>2000, Aerodeck 1.8 16V 1998>2001, CRX III 1.6 ESI 1992>1998
ALTERNATOR / ALTERNATOR:
Mitsubishi: A5T06491, A5T06491ZC, A005T04292, A5TA3591, A5T06391, 04314P08004

MITSUBISHI

GA889



FEATURES / CARACTERÍSTICAS: 14V, 'A' Circuit
REPLACES / REEMPLAZA:
Honda: 04314P0GA02; **Transpo:** IM844; **Regitar:** VRH2009-88
APPLICATION / APLICACIÓN:
HONDA: Accord VI Coupe 3.0 V6 24V 1997>2003, Accord V6 2.7 1995>1997
ALTERNATOR / ALTERNATOR:
Mitsubishi: A2TA2191

MITSUBISHI
GA893

FEATURES / CARACTERÍSTICAS: 14V, 'A' Circuit

REPLACES / REEMPLAZA:

Mitsubishi: A866X22472, A866X23072, 231002J011; **Transpo:** IM362; **Regitar:** VRH2009-118; **Cargo:** 230043; **AS Poland:** ARE5040; **Mobiletron:** VR-H2009-118; **Transpo:** IM362; **Era:** 216126

APPLICATION / APLICACIÓN:

NISSAN: 300 ZX 3.0 Twin Turbo 1989>2000

INFINITI: J30 V6 3.0 1997

ALTERNATOR / ALTERNATOR:

MITSUBISHI: A2T33593B, A2T82491A, A3TA2699B, A5T06891A, A2TA40923A

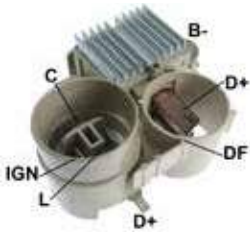
MITSUBISHI
GA896

FEATURES / CARACTERÍSTICAS: 14V, 'A' Circuit

REPLACES / REEMPLAZA:

Mitsubishi: A866X08270, A866X08271; **Honda:** 31150-PE0-927; **Transpo:** IM267; **Regitar:** VRH2009-32; **Mobiletron:** VR-H2009-32; **Cargo:** 134087

APPLICATION / APLICACIÓN:

HONDA: Civic 1.3 1.5 1983->1988, Integra, Shuttle 1.4 / 1.5 1984>1990

ALTERNATOR / ALTERNATOR:

Mitsubishi: A001T01691, A001T01591, A1T40191, A1T02191, A1T04791

Honda: 31100-PE0-906

MITSUBISHI
GA899

FEATURES / CARACTERÍSTICAS: 14V, 'A' Circuit

REPLACES / REEMPLAZA:

...

APPLICATION / APLICACIÓN:

VOLVO: Engine Volvo Penta Series D1/D2/D4/D6/D9

ALTERNATOR / ALTERNATOR:

Mitsubishi: A003TR0091, A003TR0093

Volvo: 3840181

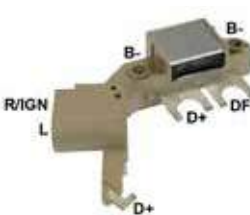
MITSUBISHI
GA900

FEATURES / CARACTERÍSTICAS: 28V, 'A' Circuit

REPLACES / REEMPLAZA:

Mitsubishi: A866X08871, A866X19972; **Transpo:** IM286; **Regitar:** VRH2009-69B; **Cargo:** 235884

APPLICATION / APLICACIÓN:

MITSUBISHI FUSO MEDIUM/HEAVY TRUCK: The Great 8DC11 1988

MITSUBISHI ENGINES INDUSTRIAL: 6D2 Diesel 1992>2007, 6D22/6D22T Diesel 1989

ALTERNATOR / ALTERNATOR:

MITSUBISHI: A004T58987, A004T58989, A004T58999, A4T66786

MITSUBISHI
GA978

FEATURES / CARACTERÍSTICAS: 14V, 'A' Circuit

REPLACES / REEMPLAZA:

Mitsubishi: A866X09270, A866X09271, MD611502; **Transpo:** IM287; **Regitar:** VRH2009-185

APPLICATION / APLICACIÓN:

MITSUBISHI: Colt MK2 hatch 1.8 GL Diesel 1984>1988, Lancer MK3 Saloon/ Estate 1.8 Diesel 1984>1988

ALTERNATOR / ALTERNATOR:

MITSUBISHI: MD099621, MD099621R, MD105606, A002T49577, A2T49577

MITSUBISHI
GA979

FEATURES / CARACTERÍSTICAS:

REPLACES / REEMPLAZA:

Valeo: 2655734; **Mobiletron:** VR-H2005-91, VR-H2009-128; **Regitar:** VRH2009-128, **AS Poland:** ARE3079; **Cargo:** 235551, **WAI/Transpo:** IY727

APPLICATION / APLICACIÓN:

HYUNDAI: HR, H-1 2500 D4CB 2003>2006, Starex 2500 D4CB 2002>2007; **KIA:** Sorento 2500 D4CB 2002>2009

ALTERNATOR / ALTERNATOR:

VALEO: TA000A64201, TA000A62401; **KIA:** 37300-42711, 37300-42474, 37300-4A112

RECTIFIER:

GA1879

MITSUBISHI

GA420



FEATURES / CARACTERÍSTICAS: 14V, 'A' Circuit

REPLACES / REEMPLAZA:

Regitar: VRMD07; **WAI/Transpo:** IY094; **AS Poland:** ARE9020

APPLICATION / APLICACIÓN:

KIA: Sephia L4 1.8L 1793cc 1998-2001, Spectra L4 1.8L 1793cc 2000-2004, Mentor 1993-1997;

MAZDA : 30X 1991 -1997, Eunos 1992>

ALTERNATOR / ALTERNATOR:

KIA: OK2A218300, OK30D18300, RK30D18300U; **MANDO:** AB170094; **DELPHI:** RM3047; **VALEO:** TA000A28801

MOTORCRAFT

GA810



FEATURES / CARACTERÍSTICAS: 14V 'A' Circuit

REPLACES / REEMPLAZA:

Ford: F5DU-10316-AA, F0DU-10316-AA, 1GR-80, E9DF-10316-AA, F0DZ-10316-A; **Motorcraft:** GR-801, GR-798; **Regitar:** GR786M; **Cargo:** 136230; **WAI/Transpo:** F794; **Magneti Marelli:** RT510198

APPLICATION / APLICACIÓN:

FORD: Escort, Explorer, Taurus, Tempo, Continental, Thunderbird, Sable, Topaz, Mercury Cougar, Tracer, Lincoln Town Car, F 1000, Ranger, F350.

ALTERNATOR / ALTERNATOR:

FORD: 3G SERIES, 1160931-FD, F02Z-10346-c, F07U-10300-AC, F09F-10300-AA, F0CF-10300-AA.

RECTIFIER:

GA1201

MOTORCRAFT

GA890



FEATURES / CARACTERÍSTICAS: 14V 'A' Circuit, brush holder assembly.

REPLACES / REEMPLAZA:

Ford: F5DU-10316-AA, F0DU-10316-AA, 1GR-80, E9DF-10316-AA, F0DZ-10316-A; **Motorcraft:** GR-801, GR-798; **Regitar:** GR786M; **Cargo:** 136230; **WAI/Transpo:** F794

APPLICATION / APLICACIÓN:

FORD: Escort, Explorer, Taurus, Tempo, Continental, Thunderbird, Sable, Topaz, Mercury Cougar, Tracer, Lincoln Town Car, F 1000, Ranger, F350.

ALTERNATOR / ALTERNATOR:

FORD: 3G SERIES, 1160931-FD, F02Z-10346-c, F07U-10300-AC, F09F-10300-AA, F0CF-10300-AA.

RECTIFIER:

GA1201

MOTOROLA

GA607 // NEW //



FEATURES / CARACTERÍSTICAS: 14V 'B' Circuit

REPLACES / REEMPLAZA:

Motorola: 9RC6145M

APPLICATION / APLICACIÓN:

THERMO KING MISC. EQUIPMENT: Super II 30 / MAX Thermo King 2.2L 1991>2003;

THERMO KING TRAILER UNIT: SB-190 Isuzu 2.2L 1999, SB-200 Yanmar 486 Diesel 1999, SB-200 30 Yanmar TK486 1999>2007, SB-300 Yanmar 486 Diesel 1999, SB-II Isuzu 2.0L Diesel 1991, SB-II MAX Isuzu 2.2L Dsl 1991, SB-III 30 Thermo King 2.2L Dsl. 1991>2003, Super II Isuzu 2.2L Dsl 1991, Super II TC Yanmar 486 Diesel 1999

ALTERNATOR / ALTERNATOR:

THERMOKING: 1E32215G01, 1E51760G01, 1E32215901, 41-6780, 41-7912, 41-5458, 44-9571, 44-8950;

PRESTOLITE: 66021606

NIKKO

GA100

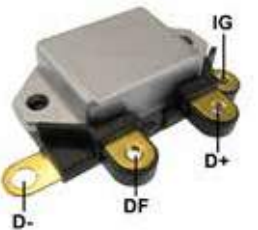

FEATURES / CARACTERÍSTICAS: 28V, 'A' Circuit | SETPOINT 28,3V

REPLACES / REEMPLAZA:

Cargo: 234999; **Isuzu:** 1812600150; **Nikko:** 0375190150, 0375190151; **Komatsu:** 6008255120

APPLICATION / APLICACIÓN:

Komatsu: Machines and Tractors PC200, PC220, PC300, WA200, WA220, GD655, GD555, D61, D41

ALTERNATOR / ALTERNATOR:

Isuzu: 1-81200-469-4, 1-81200-470-3, 1-81200-500-0, 1-81200-507-0, 1-81200-509-0, 1-81200-626-0, 8-97136-809-0, 8-97188-026-0, 8-97220-298-0; **Komatsu:** 600-825-5120, 600-825-5210, 600-825-5220, 600-825-6250

NIPPONDENSO

GA104 // NEW //



FEATURES / CARACTERÍSTICAS: 14V, 'B' Circuit

REPLACES / REEMPLAZA:

Denso: 126600-7240, MS126600-7240; **Mobiletron:** VR-F161; **Regitar:** VRF161; **AS-Poland:** ARE4019; **Cargo:** 330299; **Transpo:** IX138

APPLICATION / APLICACIÓN:

OPEL: Corsa D 1.2 2009>2011, Corsa 1.4 2006

ALTERNATOR:

DENSO: 101210-0940, 101210-0950, 101210-0951, 101210-0960, 101210-0961, 101210-0970;

OPEL: 13222929, 13222934, 13222935, 13222936, 13256932, 13256933

NIPPONDENSO
GA171 // NEW //

FEATURES / CARACTERÍSTICAS: 14V, 'B' Circuit

REPLACES / REEMPLAZA:

...

APPLICATION / APLICACIÓN:

FIAT: Mobi 1.0 2014> all with air conditioner, Strada Work 1.4, Strada Working plus 1.4, Strada hard working 1.4, Strada work 1.4 CE/CD flex all 2014>

ALTERNATOR:

DENSO: 101210-1601; **FIAT:** 51846954

RECTIFIER:

GA1322

NIPPONDENSO
GA124

FEATURES / CARACTERÍSTICAS: 14V, 'B' Circuit

REPLACES / REEMPLAZA:

Denso: 126600-3430

APPLICATION / APLICACIÓN:

FORD: Focus TDCi

ALTERNATOR / ALTERNATOR:

DENSO: 104210-3511, 104210-3512, 104210-3513, 104210-3521, 104210-3522, 104210-3523, 104210-3761, 104210-3762, 104210-5630, 104210-5631, 104210-5632, 104210-6100, 104210-6101, 104210-6102

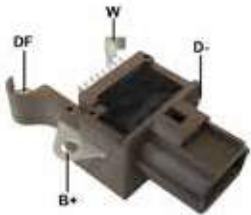
NIPPONDENSO
GA130

FEATURES / CARACTERÍSTICAS: 14V, 'B' Circuit

REPLACES / REEMPLAZA:

Denso: 126600-3640; **Regitar:** VRH2005-96; **Cargo:** 330843; **WAI/Transpo:** IN6343

APPLICATION / APLICACIÓN:

FORD: New Focus /2.0 - automatic / manual

ALTERNATOR / ALTERNATOR:

DENSO: 3 M5T 10300 LD, 3 M5T 10300 VD, 3 M5T 10300 XD, 104210-5800

NIPPONDENSO
GA134

FEATURES / CARACTERÍSTICAS: S. POINT: 2400Ω, Capacitor 2,2μF

REPLACES / REEMPLAZA:

-

APPLICATION / APLICACIÓN:

DODGE: Journey 2.7 V6 2010>, Grand Caravan V6 3.6L 2011>

ALTERNATOR:

DENSO: 4210000770, 4210000641

DODGE: P04801624AD, 4801482AB

RECTIFIER:

GA1149 / GA1150

NIPPONDENSO
GA135

FEATURES / CARACTERÍSTICAS: 14,6V 'B' Circuit, Terminals: LI, C, S.

REPLACES / REEMPLAZA:

Denso: 1266003490; **Regitar:** VRH2005-150; **Cargo:** 333034; **WAI/Transpo:** IN6349, IN6349HD

APPLICATION / APLICACIÓN:

LAND ROVER: Discovery III 4.4 2004>, Range Rover 4.2 /4.4 2005>, Range Rover Sport 4.2 /4.4 2005>

ALTERNATOR / ALTERNATOR:

DENSO: 104210369; **LAND ROVER:** YLE 500390, YLE 500190

NIPPONDENSO
GA136

FEATURES / CARACTERÍSTICAS: 14V, 'A' Circuit

REPLACES / REEMPLAZA:

Transpo: IN6342; **AS-Poland:** ARE6099S; **Mobiletron:** VR-H2005-142; **Regitar:** VRH2005-142; **Cargo:** 330289; **Era:** 216134

APPLICATION / APLICACIÓN:

LAND ROVER: Discovery III 2700 V6 2004>2009, Discovery III 4400 V8 4.4 2004>2009, Range Rover Sport 2700, V6 2005>2009, Range Rover Sport 4200 V8 2005>2009

ALTERNATOR:

DENSO: 104210-3710, 104210-3690, 104210-4010, 104210-4011, 104210-4012; **LAND ROVER:** YLE500190, YLE500190E, YLE500200, YLE500340, YLE500390, YLE500440

RECTIFIER:

GA1147

NIPPONDENSO
GA137

FEATURES / CARACTERÍSTICAS: 14V, 'B' Circuit

REPLACES / REEMPLAZA:

AS Poland: ARE6048; **Cargo:** 235831, 333029; **Mobiletron:** VR-H2005-99; **Regitar:** VRH2005-99; **WAI/Transpo:** IN6004, IN6315

APPLICATION / APLICACIÓN:

HONDA: Acura car TL V6 3.2 2004>, Acura Truck MDX V6 3.5 2003>2004

ALTERNATOR / ALTERNATOR:

Nippondenso: 1042103100, 1042103500, 1042103730, 1042103731, 1042103732, 1042103911, 1042104300, 1042104301, 1042104480, 1042104481, 1042104690, 1042104860

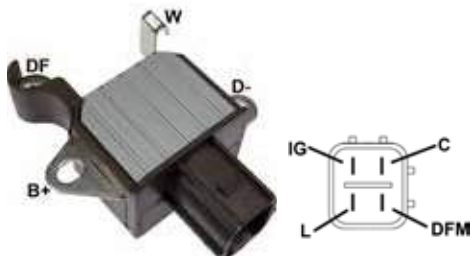
NIPPONDENSO
GA138

FEATURES / CARACTERÍSTICAS: 14V, 'B' Circuit

REPLACES / REEMPLAZA:

Nippondenso: 1266003660; **WAI/Transpo:** IN6366; **Regitar:** VRH2005-148; **Cargo:** 333033

APPLICATION / APLICACIÓN:

Honda: Accord Mk8 Saloon 2.4i 08>15; **Acura:** TSX L4 2.4 09>14

ALTERNATOR / ALTERNATOR:

DENSO: 1042105890; **HONDA:** 31100R40A01; **ACURA:** 06311-R50-505RM, 31100-R40-A01, CSF89

NIPPONDENSO
GA139

FEATURES / CARACTERÍSTICAS: 14V, 'B' Circuit

REPLACES / REEMPLAZA:

-

APPLICATION / APLICACIÓN:

TOYOTA: Corolla Gli 1.8 16V / Xei 2.0 16V 2014>

ALTERNATOR:

DENSO: 104210-7020; **TOYOTA:** 27060-0T320

RECTIFIER:

GA1144

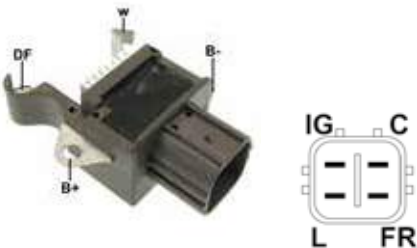
NIPPONDENSO
GA140

FEATURES / CARACTERÍSTICAS: 14V, 'B' Circuit

REPLACES / REEMPLAZA:

Denso: 126600-3350, 126600-0140; **Honda:** 31150-RAA-A010M, 31150-RAA-A030M; **Regitar:** VRH2005-90; **Cargo:** 237650; **WAI/Transpo:** IN6335; **AS Poland:** ARE6047

APPLICATION / APLICACIÓN:

HONDA: Accord, Acura, CR-V 2006>, New Civic 2012>

ALTERNATOR / ALTERNATOR:

DENSO: 104210-329, 104210-473, 104210-5370;

HONDA: 31100-RAA-A01, 31100-RAA-A03, 31100-RAA-A04, 31100-RAA-A05, 31100-RTA-003, 31100-RTA-013, 31100-RTA-023

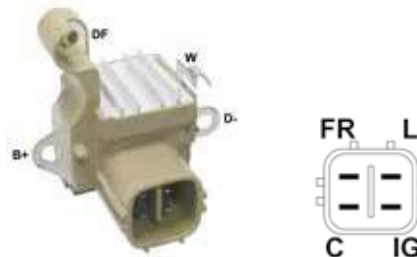
NIPPONDENSO
GA141

FEATURES / CARACTERÍSTICAS: 14V 'B' Circuit

REPLACES / REEMPLAZA:

AS Poland: ARE6048; **Cargo:** 235831, 333029; **Mobiletron:** VR-H2005-99; **Regitar:** VRH2005-99; **WAI/Transpo:** IN6004, IN6315

APPLICATION / APLICACIÓN:

HONDA: Acura Truck MDX / Pilot / Van V6 3.5L 2001>2004

ALTERNATOR / ALTERNATOR:

HONDA: 31100-PGK-A01, 31100-PGK-A02, 31100-PGK-A03, 31100-PGK-A03RM

RECTIFIER:

GA1308

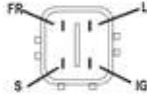
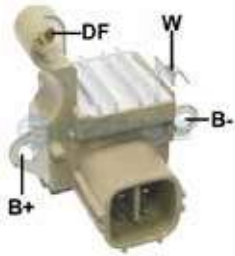
NIPPONDENSO
GA142

FEATURES / CARACTERÍSTICAS: 14,3V, 'B' Circuit, Terminals: IG, S, L, FR

REPLACES / REEMPLAZA:

Denso: 1266000150, 0150 **Regitar:** VRH2005-91A; **WAI/Transpo:** IN6015; **AS Poland:** ARE6075, ARE6100

APPLICATION / APLICACIÓN:

HONDA: CR-V

TOYOTA: Toyota Hilux Pit Bull 07>

LEXUS: GX470 V8 4.7, LX470 V8 4.7, GS430 V8 4.3, LS430 V8 4.3

ALTERNATOR / ALTERNATOR:

NIPPONDENSO: 1042109010, 1042109011, 1042103380, 1042103390, 1042103440, 1042103441, 1042103460, 1042103930, 1042104000, 1042104510, 1042105110, 1042108020, 9664219338, 9664219339, 9664219344, 9664219451

JOHN DEERE: RE202767; **LEXUS:** 27060-50320, 27060-50320-84, 27060-50330, 27060-50340, 27060-50340-84, 27060-50360, 27060-50360-84; **TOYOTA:** 27060-0F040, 27060-0F040-84, 27060-0F050, 27060-0F050-84, 27060-0F080, 27060-0F080-84, 27060-30050, 27060-50320, 27060-50320-84, 27060-50330, 27060-50360, 27060-50360-84

NIPPONDENSO
GA143

FEATURES / CARACTERÍSTICAS: 14V, 'B' Circuit

REPLACES / REEMPLAZA:

-

APPLICATION / APLICACIÓN:

FORD: Ka SE/PLUS 1.0 motor Ti Vct

ALTERNATOR:

Denso: BC104210-7001, BC104210-7002;

Ford: E3B5-10300-AB, E3B5-10300-AC

RECTIFIER:

GA1143

NIPPONDENSO
GA145

FEATURES / CARACTERÍSTICAS: 14V, 'B' Circuit

REPLACES / REEMPLAZA:

Denso: 3970-05R06; **Mobiletron:** VR-H2005-190; **Regitar:** VRH2005-190

APPLICATION / APLICACIÓN:

HONDA: CR-V IV 2.0 2012>, CR-V IV2.0 AWD 2012>

ALTERNATOR:

Denso: 104210-1530, 104210-1540, 1042101650, 104210-5370, 1042118280;

Honda: 31100-R1P-H01

RECTIFIER:

GA1145

NIPPONDENSO
GA147

FEATURES / CARACTERÍSTICAS: 14V, 'B' Circuit

REPLACES / REEMPLAZA:

Denso: 1266003010, 1266003040, 1266003390, 2770020090, 2770020100; **Regitar:** VRH2005-85A, VRH2005-146A; **Mobiletron:** VR-H2005-85, VR-H2005-146; **Cargo:** 236329; **WAI/Transpo:** 107301, IN6301; **AS Poland:** ARE6039, ARE6090

APPLICATION / APLICACIÓN:

TOYOTA: Corolla 2008>, Camry 2008>, RAV4 2005>

ALTERNATOR / ALTERNATOR:

DENSO: 104210-5481, 104210-3780, 104210-2802, 104210-2801, 104210-2803;

TOYOTA: 27060-37081, 27060-37041, 27060-28260

RECTIFIER:

GA1317

NIPPONDENSO
GA152

FEATURES / CARACTERÍSTICAS: 14V, 'B' Circuit

REPLACES / REEMPLAZA:

Denso: 1266003080, 1266003830; **Transpo:** IN6308; **Regitar:** VRH2005-152H; **Mobiletron:** VR-H2005-152

APPLICATION / APLICACIÓN:

SATURN TRUCK: Vue V6 3.5L 2006>2007, Vue V6 3.5L 2004>2005, Vue V6 3.5L 2004

ALTERNATOR / ALTERNATOR:

Denso: 1042103770, 1042105810

Honda: 31100-RDM-A01, 31100-RDM-A01RM

NIPPONDENSO
GA154 // NEW //

FEATURES / CARACTERÍSTICAS: 14V, 'B' Circuit

REPLACES / REEMPLAZA:
Denso: 126600-3910

APPLICATION / APLICACIÓN:
FIAT: 500 L4 1.4L 2012>2016

ALTERNATOR:
DENSO: 104210-1750;

FIAT: P5602958AB, K5602958AB

NIPPONDENSO
GA158

FEATURES / CARACTERÍSTICAS: 14V, 'B' Circuit

REPLACES / REEMPLAZA:

...

APPLICATION / APLICACIÓN:
JEEP: Renegade

ALTERNATOR:
Denso: 104211-3210

RECTIFIER:

GA1142

NIPPONDENSO
GA159 // NEW //

FEATURES / CARACTERÍSTICAS: 14V, 'B' Circuit

REPLACES / REEMPLAZA:
Denso: 126600-3240, 126600-3440, 126600-4310; **Transpo:** IN6324; **AS Poland:** ARE6079; **Mobiletron:** VR-H2005-101;

Regitar: VRH2005-101

APPLICATION / APLICACIÓN:
CHEVROLET: S10 2.5 Sidi Ecotec Flex 2015->, Cruze 1.4 Turbo 2017

ALTERNATOR:
CHEVROLET: 13592810, 13587309

DENSO: 104210-1902, 104210-200, 104210-2000, 104210-2001, 104210-3191, 104210-3260, 104210-3261, 104210-3320, 104210-4220, 104210-4330, 104210-4340, 104210-4350, 104210-4360, 104210-4370, 104210-4420, 104210-4430, 104210-5390, 104210-5990, 104210-6000, 104210-6001, 104210-6110, 104210-6160, 104211-3720

RECTIFIER:

GA1141 / GA1149

NIPPONDENSO
GA160 // NEW //

FEATURES / CARACTERÍSTICAS: 14V, 'B' Circuit - RVC SYSTEM

REPLACES / REEMPLAZA:
Transpo: IN6329; **Mobiletron:** VR-H2005-163; **Cargo:** 333807

APPLICATION / APLICACIÓN:
GM: Impala 3.8 V6 1999>2005, Monte Carlo V6 3.9L 2006

ALTERNATOR:
DENSO: 021080-0170, 104210-2160, 104210-2890, 104210-4560, 104210-5070, 104210-5380, 104210-5410;

CHEVROLET: 10335498, 15826299, 15846253, 20841889, 25862643, 96673483

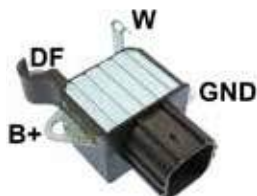
NIPPONDENSO
GA162 // NEW //

FEATURES / CARACTERÍSTICAS: 14V, 'A' Circuit

REPLACES / REEMPLAZA:
Denso: 126600-3020, 126600-3220, 126600-3320; **Mobiletron:** VR-H2005-95; **Regitar:** VRH2005-95; **AS-Poland:** ARE6068;

Cargo: 330529; **Transpo:** IN6302

APPLICATION / APLICACIÓN:
LEXUS: LS460 V8 4.6 2007>2012

TOYOTA: Avensis T25 2000 2006>2009, Avensis T25 2200 2005>2010, Corolla Verso 2200 2005>2010

ALTERNATOR:
DENSO: 04210-2080, 104210-2090, 104210-2091, 104210-2092, 104210-2320, 104210-2520, 104210-4520, 104210-4521, 104210-4590, 104210-4591, 104210-4740, 104210-4750, 104210-4790, 104210-4791, 104210-4792, 104210-4793, 104210-4794, 104210-4795, 104210-6130, 104210-6131;

LEXUS: 27060-38040, 27060-38041;

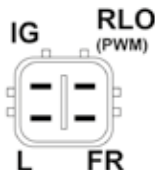
TOYOTA: 27060-0G010, 27060-0G011, 27060-0G021, 27060-0N040, 27060-0N050, 27060-28300, 27060-28301, 27060-2830184, 27060-31090, 27060-31091, 27060-31091, 27060-31091-84, 27060-31100, 27060-31101, 27060-31102, 27060-33100

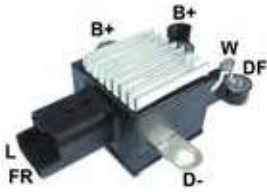
NIPPONDENSO
GA163 // NEW //

FEATURES / CARACTERÍSTICAS: 14V, 'B' Circuit

REPLACES / REEMPLAZA:
Mobiletron: VR-H2005-83; **Regitar:** VRH2005-83; **AS-Poland:** ARE6037; **Cargo:** 235457; **Transpo:** IN317; **Era:** 215667

APPLICATION / APLICACIÓN:
ALFA ROMEO: 159 2400 2006>2010, 159 Sportwagon 2.4 2006>2011, Brera 2400 2006>2010, Spider 2400 2007>2012

FIAT: Cromia 2400 2006>2010

ALTERNATOR:
DENSO: 104210-2780, 104210-3170, 104210-3240, 104210-4240, 104210-4241, 104210-5020

FIAT: 50500728, 51734825

NIPPONDENSO
GA213 // NEW //

FEATURES / CARACTERÍSTICAS: 14V, 'A' Circuit

REPLACES / REEMPLAZA:
Hitachi: GD312184-A, L150-73155; **Isuzu:** 8-94462-849-0, 8944103350; **Transpo:** IH244; **Mobiletron:** VR-H2000-9

APPLICATION / APLICACIÓN:
ISUZU: Amigo L4 2.3L/2.6L 1989>1992, Pickup L4 2.3L/2.6L 1988>1991, Rodeo L4 2.6L 1991>1992, Trooper L4 2.3L 1986>1987, Trooper L4 2.6L 1988>1991

ALTERNATOR:
HITACHI: LR150-704, LR150-704H, LR160-718, LR160-718H, LR160-725;

ISUZU: 2-91276-336-ORM, 2912763360, 2912769200, 2912769300, 2912769320, 8943367300, 8943367310, 8944367300, 8944492650, 8944492660, 8970630260, 8970845790

NIPPONDENSO
GA107

FEATURES / CARACTERÍSTICAS: 28V, 'A' Circuit

REPLACES / REEMPLAZA:

...

APPLICATION / APLICACIÓN:
CATERPILLAR: Agricultural machinery

ALTERNATOR / ALTERNATOR:

...

NIPPONDENSO
GA450

FEATURES / CARACTERÍSTICAS: 14V, 'A' Circuit

REPLACES / REEMPLAZA:
Nippondenso: 126000-0920, 126000-1421, 126000-1460, 270006-4040, 270006-4110, 270205-4344; **Transpo:** IN920;

Cargo: 133526

APPLICATION / APLICACIÓN:
TOYOTA: Carina II 2.0 1985>1987, Carina II Stufenheck 2.0 1988>1992, Carina II Station Wagon 2.0 1987>1992

ALTERNATOR / ALTERNATOR:
Nippondenso: 100213075, 100213076, 100213081, 100213092, 100213095, 100213096, 100213098, 100213121, 100213142, 100213145, 100213150, 100213275, 121000275, 121000502

NIPPONDENSO
GA451

FEATURES / CARACTERÍSTICAS: 14V, 'A' Circuit

REPLACES / REEMPLAZA:
Denso: 126000-0920, 126000-1421, 126000-1460; **Transpo:** IN921; **Regitar:** VRH2005-2W; **Cargo:** 231197

APPLICATION / APLICACIÓN:
TOYOTA: Corolla Liftback/Compact/Station Wagon 1.8 1987>1995, Carina II Stufenheck/Station Wagon 2.0 1987>1992

ALTERNATOR / ALTERNATOR:
DENSO: 1002115950, 1002130810, 1002130811, 1002130812, 1002131120, 1002131210, 1002131420, 1002131421, 1002131450, 1002131500, 1002132560, 1012116140, 1210002750, 1210002751, 1210007750

TOYOTA: 2702064210, 2702064211, 2702064220, 2702064221, 2704064130, 2704064131, 2704064140, 2704064141

NIPPONDENSO
GA166 // NEW //

FEATURES / CARACTERÍSTICAS: 14V, 'A' Circuit

REPLACES / REEMPLAZA:

Denso: 126000-3130, 126000-3170, 126000-3171; **Mobiletron:** VRH2005-65; **Regitar:** VRH2005-65; **Cargo:** 234091; **AS-Poland:** ARE6034; **Transpo:** IN447, IN447HD

APPLICATION / APLICACIÓN:

SCION VAN: xB L4 1.5 2004>2006;

TOYOTA: Echo L4 1.5 2004>2005, Yaris 1300 16V 1999>2002, Yaris 1500 16V 2001>2010, Yaris Verso 1300 16V 2001>2010

ALTERNATOR:

SCION: 27060-21030, 27060-21030-84, 27060-21031, 27060-21031-84, 27060-21140, 27060-21140-84;

TOYOTA: 27060-21010, 27060-21020, 27060-21030, 27060-21030-84, 27060-21031, 27060-21031-84, 27060-21040, 27060-21041, 27060-21140, 27060-33010, 270602102084

NIPPONDENSO
GA168 // NEW //

FEATURES / CARACTERÍSTICAS: 14V, 'A' Circuit

REPLACES / REEMPLAZA:

Denso: 126000-2861, 126000-3040, 126000-3041; **Toyota:** 27700-23010; **Cargo:** 231462; **AS-Poland:** ARE6036; **Transpo:** IN304; **Mobiletron:** VR-H2005-62A; **Regitar:** VRH2005-62A

APPLICATION / APLICACIÓN:

TOYOTA: Yaris 1000 16V 1999>2003

ALTERNATOR:

DENSO: 102211-1680, 102211-5210, 102211-5250, 102211-5410, 102211-9820, 102211-9880;

TOYOTA: 27060-23020, 27060-23030, 27060-23070, 27060-23010

NIPPONDENSO
GA766

FEATURES / CARACTERÍSTICAS: 14V, 'B' Circuit

REPLACES / REEMPLAZA:

Transpo: IN454; **Regitar:** VRH2005-92; **Cargo:** 235887; **Mobiletron:** VR-H2005-92; **AS Poland:** ARE6043

APPLICATION / APLICACIÓN:

HYUNDAI: Azera 3.3/3.8 V6 2007>2011, Sonata 3.3 V6 2006>2009, Santa Fé 3.3 V6 2006>2009, Veracruz 3.8 V6 2007>2012

KIA: Borrego 3.8 V6 2010>2011, Sorento 3.3 V6 2008>2009, Sorento 3.8 V6 2007>2009

ALTERNATOR / ALTERNATOR:

DENSO: 02131-9153; **HYUNDAI/KIA:** 37300-3C120

RECTIFIER:

GA1256

NIPPONDENSO
GA820

FEATURES / CARACTERÍSTICAS: 14V, 'A' Circuit, Mount. 63,5 mm, S-IG-L, Terminal 'L' without drive choke

REPLACES / REEMPLAZA:

Nippondenso: 126000-1580, 126000-1640, 126000-1670; **Toyota:** 27700-35040, 27700-74030, 27700-75030, 126000-1660; **Regitar:** VRH2005-31A; **Cargo:** 135734; **WAI/Transpo:** IN439

APPLICATION / APLICACIÓN:

TOYOTA: Camry 2.2L 70A, Celica 2.2L 70A, MR2, Paseo W/O Heatshield.

ALTERNATOR / ALTERNATOR:

NIPPONDENSO: 1002115020, 1002116390, 1002116440, 1002115110, 1002116460, 100211644

RECTIFIER:

GA1255

NIPPONDENSO
GA850

FEATURES / CARACTERÍSTICAS: 14V 'A' Circuit, 63.5 mm Mounting; Terminals: C-IG-L, Terminal 'L' with drive choke

REPLACES / REEMPLAZA:

Nippondenso: 126000-2150, 126000-2151; **Regitar:** VRH2005-77; **Cargo:** 234731; **WAI/Transpo:** IN215

APPLICATION / APLICACIÓN:

HONDA: 1996-97 Acura SLX3.2L;

ISUZU: Trooper 3.2L (all 75 Ampere)

ALTERNATOR / ALTERNATOR:

NIPPONDENSO: 1012114220; **ISUZU:** 2901237800, 2901237801, 8971097800, 8971097801

NIPPONDENSO
GA851

FEATURES / CARACTERÍSTICAS: 14V 'A' Circuit, 63.5 mm Mounting; Terminals: S-IG-L, Terminal 'L' with drive choke

REPLACES / REEMPLAZA:

Nippondenso: 126000-1730, 126000-1750, 126000-1930; **Regitar:** VRH2005-30A; **Cargo:** 135737; **WAI/Transpo:** IN437

APPLICATION / APLICACIÓN:

TOYOTA: Tercel, Toyota Paseo 1.5 L, Camry 2.2L, Landcruiser 4.5L

ALTERNATOR / ALTERNATOR:

NIPONDENSO: 1002116390, 1002110060, 1002110070, 1002110120, 1002110190, 1002110340, 1002110350, 1002110420, 1002110430, 1002110520, 1002110530, 1002110590, 1002110740, 1002115010, 1002115080, 1002115090, 100211510, 1002110450, 1002115150, 1002115160, 1002115460, 1002115550, 1002115970, 1002117060, 1002117180, 1002119510, 1002111270, 1002111280, 1002111290, 1002111300, 1002111320, 1002111330, 1002115100, 1002115140, 1002115150; **TOYOTA:** 2706011270, 2706011280, 2706011290, 2706011300, 2706011320, 2706011330, 2706015100, 2706015140, 2706035150, 2706066040, 2706072920, 2706074390, 2706075040, 2706075100, 2706082090.

NIPPONDENSO
GA852

FEATURES / CARACTERÍSTICAS: 14V 'A' Circuit, 63.5 mm Mounting, Terminals: S-IG-L, Terminal 'L' without drive choke

REPLACES / REEMPLAZA:

Nippondenso: 126000-7100; **Regitar:** VRH2005-35; **Cargo:** 135734; **WAI/Transpo:** IN440

APPLICATION / APLICACIÓN:

TOYOTA: Pick-up 3.0L, T-1000 3.0L

ALTERNATOR / ALTERNATOR:

NIPONDENSO: 1012110130, 1012110300, 1012117010; **PIC:** 290351; **TOYOTA:** 2706065040; **LESTER:** 13496.

NIPPONDENSO
GA853

FEATURES / CARACTERÍSTICAS: 14V 'A' Circuit, 63.5 mm Mounting, Terminals: P-IG-L, Terminal 'L' without drive choke

REPLACES / REEMPLAZA:

Nippondenso: 126000-1940; **Regitar:** VRH2005-59; **Cargo:** 138638; **WAI/Transpo:** IN449

APPLICATION / APLICACIÓN:

CATERPILLAR;

YANMAR;

ALTERNATOR / ALTERNATOR:

NIPONDENSO: 1012119010, 1012119940

NIPPONDENSO
GA854

FEATURES / CARACTERÍSTICAS: 14V 'A' Circuit, 63.5 mm Mounting, Terminals: S-IG-L, Terminal 'L' without drive choke

REPLACES / REEMPLAZA:

Nippondenso: 126000-1960, 126000-2050, 126000-2200, 126000-2250; **Regitar:** VRH2005-46A; **Cargo:** 139584; **WAI/Transpo:** IN453

APPLICATION / APLICACIÓN:

LEXUS;

TOYOTA: 4Runner, Tacoma, Toyota T100

ALTERNATOR / ALTERNATOR:

NIPONDENSO: 1012114120, 1012114131; **LESTER:** 13670, 13671, 13673; **TOYOTA:** 2706062110, 2706062180, 2706075170; **PIC:** 290380

NIPPONDENSO
GA855

FEATURES / CARACTERÍSTICAS: 14V, 'A' Circuit

REPLACES / REEMPLAZA:

Denso: 1260002090, 1260002160, 1260002170, 1260002610, 1260003030; **Honda:** 31150P2T003, 31150P2T0030, 31150PEAA01, 31150PV40030; **Magneti Marelli:** 940038097; **Regitar:** VRH2005-40; **Cargo:** 234557; **WAI/Transpo:** IN445

APPLICATION / APLICACIÓN:

Acura, Honda, Isuzu (1996-2003)

ALTERNATOR / ALTERNATOR:

DENSO: 101211-9380, 101211-9390, 101211-9820, 102211-1260;

NIPPONDENSO
GA822

FEATURES / CARACTERÍSTICAS: 14V, 'A' Circuit, Terminals: P-IG-L, Mount. 57,5 mm, Terminal 'L' without drive choke

REPLACES / REEMPLAZA:

Nippondenso: 126000-1800; **Regitar:** VRH2005-60; **Cargo:** 138146; **WAI/Transpo:** IN450

APPLICATION / APLICACIÓN:

CATERPILLAR: Machinery and Equipment;

ACURA: Integra;

HONDA: Civic

ALTERNATOR / ALTERNATOR:

NIPPONDENSO: 101211-2310, 105-2812; **CATERPILLAR:** 333-224

NIPPONDENSO
GA860

FEATURES / CARACTERÍSTICAS: 14V 'A' Circuit, 57.5 mm Mounting, Terminals: S-IG-L, Terminal 'L' with drive choke

REPLACES / REEMPLAZA:

Nippondenso: 126000-1630, 126000-3480; **Regitar:** VRH2005-32A; **Cargo:** 138662; **WAI/Transpo:** IN257

APPLICATION / APLICACIÓN:

TOYOTA: Tercel 1.5 W/MT.

ALTERNATOR / ALTERNATOR:

NIPPONDENSO: 1012112130; **PIC:** 290386; **LESTER:** 13485; **TOYOTA:** 2706011250

NIPPONDENSO
GA861

FEATURES / CARACTERÍSTICAS: 28V, 'A' Circuit. Terminals NC, IG, L. OD 63mm

REPLACES / REEMPLAZA:

Nippondenso: 1260002320; **Regitar:** VRH2005-151B; **Cargo:** 333040; **WAI/Transpo:** IN462

APPLICATION / APLICACIÓN:

KOMATSU

ALTERNATOR / ALTERNATOR:

NIPPONDENSO: 1012117960, 1022114050, 6008616410, 6008616420, 1022112850

NIPPONDENSO
GA816

FEATURES / CARACTERÍSTICAS: 14V 'A' Circuit, 57.5 mm Mounting, Terminals: D-IG-L, Terminal 'L' with drive choke

REPLACES / REEMPLAZA:

Nippondenso: 126000-0850, 126000-0880, 126000-1370; **Regitar:** VRH2005-24; **Cargo:** 132860; **WAI/Transpo:** IN251

APPLICATION / APLICACIÓN:

CHEVROLET: Spectrum L4 1.5L; **OPEL:** Monterey V6 3.2L

GEO CAR: Spectrum 1.5L, Metro 1.0/ 1.3L

ISUZU: I-Mark L4 1.5L, Trooper V6 3.2L

PONTIAC: Sunburst 1.5L, Firefly 1.0

SUZUKI: Swift 1.0/ 1.3L

JOHN DEERE: Excavator 27C ZTS, 27 ZTS, 35C ZTS, 35 ZTS, 50C ZTS, 50 ZTS, Tractor 5403 4.5, 5410 4.5, 5415, 5415H, 5420, 5510, 5515, 5515F 8V, 5520, 5615, 5615F 8V, 5715, 5715HC, 5420N, 5510N, 5520N

ALTERNATOR / ALTERNATOR:

NIPPONDENSO: 1002111410, 1002114130, 1002114140, 1002114260, 1002116270, 1002116600, 1012112020;

ISUZU: 8944497810, 8944497810; **SUZUKI:** 3140060B40; **LESTER:** 13214, 13316, 13414, 13522, 14733; **PIC:** 290210A, 290210B, 290240C, 290320, 290383

NIPPONDENSO
GA817

FEATURES / CARACTERÍSTICAS: 14V 'A' Circuit, 57.5 mm Mounting, Terminals: C-IG-L, Terminal 'L' with drive choke

REPLACES / REEMPLAZA:

Nippondenso: 126000-0840; **Regitar:** VRH2005-25; **Cargo:** 138664; **WAI/Transpo:** IN252

APPLICATION / APLICACIÓN:

CHEVROLET: Sprint, Geo Sprint.

ALTERNATOR / ALTERNATOR:

NIPPONDENSO: 1002114110, 1002114111, 1002114150; **GM:** 96056770; **SUZUKI:** 3140086210; **LESTER:** 14937; **PIC:** 290258

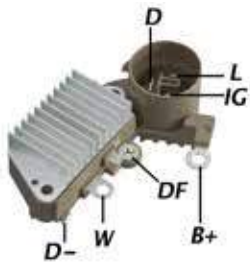
NIPPONDENSO
GA818

FEATURES / CARACTERÍSTICAS: 14V 'A' Circuit, 57,5 mm Mounting, Terminals: D-IG-L, Terminal 'L' without drive choke

REPLACES / REEMPLAZA:

Nippondenso: 126000-0720, 126000-1330; **Regitar:** VRH2005-26; **Cargo:** 133257; **WAI/Transpo:** IN253

APPLICATION / APLICACIÓN:

CHEVROLET: Chevy Sprint, Geo Metro;

SUZUKI: Sidekick, Pontiac Firefly (Canada only)

ALTERNATOR / ALTERNATOR:

NIPPONDENSO: 1002111570, 1002116720, 1002111571, 1002116990, 1002114070, 1002119190, 1002114141, 1002119320,

1002116710, 1002119340; **ISUZU:** 8944541880; **SUZUKI:** 3140060840, 3140086010, 3140086510; **LESTER:** 13255, 14870;

PIC: 290212, 290212B, 290240, 290246

NIPPONDENSO
GA819

FEATURES / CARACTERÍSTICAS: 14V 'A' Circuit, Mount: 57,5 mm, Terminals: S-IG-L, Terminal 'L' with drive choke

REPLACES / REEMPLAZA:

Nippondenso: 126000-7040; **Regitar:** VRH2005-23A; **Cargo:** 134700; **WAI/Transpo:** IN256

APPLICATION / APLICACIÓN:

TOYOTA: Forklifts

ALTERNATOR / ALTERNATOR:

NIPPONDENSO: 1002114540, 1002116931, 1002116930, 1002116960; **PIC:** 290185, 290206, 290207, 290227;

TOYOTA: 2706078003, 2706078305, 2707023041; **LESTER:** 12183, 12184, 12187

NIPPONDENSO
GA821

FEATURES / CARACTERÍSTICAS: 14V 'A' Circuit, Mount. 57,5 mm, S-IG-L, Terminal 'L' with drive choke

REPLACES / REEMPLAZA:

Nippondenso: 126000-0550, 126000-0980, 126000-1550, 126000-1570; **Regitar:** VRH2005-23A; **Cargo:** 132855; **WAI/Transpo:** IN250

APPLICATION / APLICACIÓN:

DAIHATSU: Charade;

TOYOTA: Tercel

ALTERNATOR / ALTERNATOR:

NIPPONDENSO: 02100843, 0210008430; **DAIHATSU:** 2706087706

NIPPONDENSO
GA823

FEATURES / CARACTERÍSTICAS: 14V 'A' Circuit, Mount. 63,5 mm, Terminals: B+, DF, Estator, D-, IG, L, Terminal 'L' without drive choke

REPLACES / REEMPLAZA:

Nippondenso: 126000-0371, 126000-0580; **Regitar:** VRH2005-14; **Cargo:** 132646; **WAI/Transpo:** IN227

APPLICATION / APLICACIÓN:

DAIHATSU: Charade;

TOYOTA: Forklifts

ALTERNATOR / ALTERNATOR:

NIPPONDENSO: 1.002.111.402, 1.002.111.452, 1.002.112.330; **TOYOTA:** 2.706.087.701

NIPPONDENSO
GA824

FEATURES / CARACTERÍSTICAS: 14V 'A' Circuit, Mounting 63,5 mm, Terminals: C-FR-IG-L, Terminal 'L' with drive choke

REPLACES / REEMPLAZA:

Nippondenso: 126000-0940, 126000-1030, 126000-1700, 126000-1410, 126000-1300; **Regitar:** VRH2005-10; **Cargo:** 132859; **WAI/Transpo:** IN224

APPLICATION / APLICACIÓN:

HONDA: Accord, Civic, Acura.

ALTERNATOR / ALTERNATOR:

NIPPONDENSO: 1.002.113.590, 1.002.113.660, 1.002.113.690, 1.002.118.150, 1.002.118.550, 1.002.118.710, 1.002.118.750,

1.002.118.770; **HONDA:** CHA-50, 31100-PT3-A51, 31100-PT3-A52, 31100-PM5-A01, 31100-PM8-A01, 31100-PM8-A03;

LESTER: 13325, 14989, 13395, 13507, 13508, 13509, 13540, 14755

NIPPONDENSO
GA826

FEATURES / CARACTERÍSTICAS: 14V 'A' Circuit, 63.5 mm Mounting, Terminals: D-IG-L, Terminal 'L' without drive choke

REPLACES / REEMPLAZA:

Nippondenso: 126000-0410, 126000-0411, 126000-0470; **Regitar:** VRH2005-7A; **Cargo:** 131526; **WAI/Transpo:** IN219

APPLICATION / APLICACIÓN:

HONDA: Civic 1.2,1.3,1.5, Civic Coupé; **SUZUKI:** SJ 413, Swift 1.3; **TOYOTA:** Celica 2.0, Crown SI

ALTERNATOR / ALTERNATOR:

NIPONDENSO: 100211138, 100211400, 100211410, 100211411, 100212221, 100212231, 100213020, 100213380, 100213640, 100214070, 100212290; **LESTER:** 14684, 14737; **HONDA:** 31100PE0013, 31100PE6013; **PIC:** 290163, 29212A; **SUZUKI:** 3140082611, 9651973, 96054116

NIPPONDENSO
GA827

FEATURES / CARACTERÍSTICAS: 14V 'A' Circuit, 63.5 mm Mounting, Terminals: S-IG-L, Terminal 'L' with drive choke

REPLACES / REEMPLAZA:

Nippondenso: 126000-0340, 126000-0400, 126000-0510, 126000-0650, 126000-0700, 126000-0731, 126000-340;

Regitar: VRH2005-4A; **Cargo:** 131459; **WAI/Transpo:** IN220

APPLICATION / APLICACIÓN:

HONDA: Accord 2.0i, Prelude, Civic 1.2/ 1.3/ 1.5, Civic Coupé; **SUZUKI:** SJ 413 1.3, Swift 1.3; **TOYOTA:** Camry 1.8/ 2.0, Carina II 1.8, Celica Coupé, Celica Supra, Corolla 1.3, Corolla Coupé, MR 2 1.6/ 2.0, Starlet 1.0/ 1.3/ 1.5, Supra 3.0 Turbo.

ALTERNATOR / ALTERNATOR:

NIPONDENSO: 1002111000, 1002111001, 1002111010, 1002111011, 1002111020, 1002111021, 1002111030, 1002111031, 1002111040, 1002111041, 1002111050, 1002111060, 1002111061, 1002111070, 1002111074, 1002111080, 1002111090, 1002111091, 1002111100, 100211110, 1002111130, 1002111131, 1002111140, 1002111141, 1002111150, 1002111160, 1002111170, 1002111171, 1002111180, 1002111200, 1002111201, 1002111210, 1002111212, 1002111220, 1002111224, 1002111230, 1002111231, 1002111250, 1002111251, 1002111320, 1002111340, 1002111341, 1002111360, 1002111440, 1002111840, 1002112000, 1002112001, 1002112020, 1002112021, 1002112030, 1002112031, 1002112040, 1002112050, 1002112060, 1002112070, 1002112071, 1002112080, 1002112100, 1002112102, 1002112110, 1002112150, 1002112160, 1002112170, 1002112190, 1002112210, 1002112250, 1002112280, 1002112300, 1002112370

NIPPONDENSO
GA828

FEATURES / CARACTERÍSTICAS: 14V 'A' Circuit

REPLACES / REEMPLAZA:

Nippondenso: 126000-0440, 126000-1310; **Regitar:** VRH2005-6; **Cargo:** 132856; **WAI/Transpo:** IN222

APPLICATION / APLICACIÓN:

HONDA: Civic 1.3 83-87, 1.5 83-87, Integra 1.5 until 87, Shuttle;

LAND ROVER: 213 84-90;

ISUZU: Gemini 1.6 Gti 16V 87-88

ALTERNATOR / ALTERNATOR:

NIPONDENSO: 10211-1260, 100211-1261, 10211-2210, 100211-2211, 100211-3720

NIPPONDENSO
GA829

FEATURES / CARACTERÍSTICAS: 14V 'A' Circuit, 63.5 mm Mounting, Terminals: C-IG-L, Terminal 'L' with drive choke

REPLACES / REEMPLAZA:

Nippondenso: 126000-0430; **Regitar:** VRH2005-5; **Cargo:** 134447; **WAI/Transpo:** IN221; **Magneti Marelli:** RT510215

APPLICATION / APLICACIÓN:

HONDA: Civic 1.2/ 1.3/ 1.5, Civic Coupé;

SUZUKI: SJ 413, Swift 1.3;

TOYOTA: Celica 2.0, Crown SI

ALTERNATOR / ALTERNATOR:

NIPONDENSO: 002110160, 002111270, 002111310, 002111330, 002111331, 002111371, 002119730, 1002111430, 1002112220, 1002112230, 1002117950, 1002117951; **LESTER:** 13391, 13524, 14732, 14733, 14757; **HONDA:** 31100PE00030; **ISUZU:** 8941373452; **PIC:** 290210, 290211, 290213, 290315, 290329

NIPPONDENSO
GA831

FEATURES / CARACTERÍSTICAS: 14V 'A' Circuit, 63.5 mm Mounting, Terminals: S-IG-L, Terminal 'L' without drive choke

REPLACES / REEMPLAZA:

Nippondenso: 126000-0610, 126000-1110, 126000-1440, 126000-1441; **Regitar:** VRH2005-33A; **Cargo:** 135730; **WAI/Transpo:** IN434

APPLICATION / APLICACIÓN:

TOYOTA: Celica, MR2 W/Opt. 100A

ALTERNATOR / ALTERNATOR:

NIPONDENSO: 1002113400, 1002116060, 1002116110, 1002116350, 1002116370, 1002117040, 1002117100, 1002117180, 1002117470, 1002117780, 1002117820, 1002117960, 1002118110, 1002118230, 1002118320, 1002118380, 1002118390, 1002118450, 1002118470, 1002118480, 1002118500, 1002118590, 1002119840, 1012115210; **LESTER:** 13234, 13276, 13319, 13321, 13384, 13385, 13393, 13411, 13498, 13562, 13566, 13894; **PIC:** 290219A, 290237, 290252, 290253, 290271, 290280, 290286, 290307, 290310C, 290314, 290325, 290330, 290348; **TOYOTA:** 2706035130, 2706046010, 2706046020, 2706050010, 2706062050, 2706065030, 2706074090, 2706074170, 2706074180, 2706074190, 2706074210, 2706074240, 2706074280, 2706074281

NIPPONDENSO
GA832

FEATURES / CARACTERÍSTICAS: 14V 'A' Circuit, 63.5 mm Mounting, Terminals: D-IG-L, Terminal 'L' with drive choke

REPLACES / REEMPLAZA:

Nippondenso: 126000-1200; **Regitar:** VRH2005-16A; **Cargo:** 134447; **WAI/Transpo:** IN435

APPLICATION / APLICACIÓN:

HONDA: Accord 2.0i, Prelude, Civic 1.2/ 1.3/ 1.5, Civic Coupé;

SUZUKI: SJ 413 1.3, Swift 1.3;

TOYOTA: Camry 1.8/ 2.0, Carina II 1.8, Celica Coupé, Celica Supra, Corolla 1.3, Corolla Coupé, MR 2 1.6/ 2.0, Starlet 1.0/ 1.3/ 1.5, Supra 3.0 Turbo.

ALTERNATOR / ALTERNATOR:

NIPPONDENSO: 1002116310, 1002118680, 1002117952, 1002118980, 1002117990, 1012110160, 1002118530; **LESTER:** 13423, 13424, 13521, 13569, 14391; **PIC:** 290333, 290334, 290384; **ISUZU:** 8940236520, 8970638121

NIPPONDENSO
GA833

FEATURES / CARACTERÍSTICAS: 14V 'A' Circuit, 63.5 mm Mounting, Terminals: S-IG-L, Terminal 'L' with drive choke

REPLACES / REEMPLAZA:

Nippondenso: 126000-0931, 126000-0932, 126000-1400, 126000-1450, 126000-1530; **Regitar:** VRH2005-17A; **Cargo:** 131459;

WAI/Transpo: IN436

APPLICATION / APLICACIÓN:

HONDA: Accord 2.0i, Prelude, Civic 1.2/ 1.3/ 1.5, Civic Coupé;

SUZUKI: SJ 413 1.3, Swift 1.3;

TOYOTA: Camry 1.8/ 2.0, Carina II 1.8, Celica Coupé, Celica Supra, Corolla 1.3, Corolla Coupé, MR 2 1.6/ 2.0, Starlet 1.0/ 1.3/ 1.5, Supra 3.0 Turbo.

ALTERNATOR / ALTERNATOR:

NIPPONDENSO: 1002113050, 1002117450, 1002113240, 1002117460, 1002113391, 1002117580, 1002113500, 1002118030, 1002113520, 1002118050, 1002113680, 1002118060, 1002116030, 1002118070, 1002116050, 1002118090, 1002116410, 1002118170, 1002116420, 1002118360, 1002117130, 1002118640, 1002117140, 1002118860, 1002117440, 1002119700; **TOYOTA:** 2706003010, 2706010011, 2706011020, 2706011030, 2706011060, 2706011220, 2706016230, 2706016260, 2706042030, 2706050040, 2706055011, 2706055030, 2706055050, 2706062012, 2706062040, 2706072062, 2706072071, 2706072150, 2706072171, 2706072180, 2706074080, 2706075050, 2731016131

NIPPONDENSO
GA834

FEATURES / CARACTERÍSTICAS: 14V 'A' Circuit, 63.5 mm Mounting, Terminals: S-IG-L, Terminal 'L' with drive choke

REPLACES / REEMPLAZA:

Nippondenso: 126000-1260, 126000-1270, 126000-1110; **Toyota:** 27700-46030, 27700-46040; **Regitar:** VRH2005-18A; **Cargo:** 135731; **WAI/Transpo:** IN438

APPLICATION / APLICACIÓN:

TOYOTA: Celica, MR2; **JOHN DEERE:** (1993-2007); **LEXUS:** (1992-1994)

ALTERNATOR / ALTERNATOR:

NIPPONDENSO: 1002116110, 1002116180, 1002116300, 1002116330, 1002116340, 1002118750, 1002116360, 1002117910, 1002117930, 1002118560, 1002118570, 1002118810, 1002118820, 1002118870, 1002119780, 1002119890, 1002115360, 1002116410, 1002116420, 1002117470, 1002118330, 1002118660, 1002118670, 1002118830, 1002119790, 1012115220, 9760211747; **PIC:** 290219B, 290284, 290284A, 290285, 290285A, 290288, 290298, 290299, 290311A, 290340, 290341, 290344, 290347, 290311;

JOHN DEERE: RE46608, SE501380, TY6762;

LEXUS: 27060-46030, 27060-50040, 27060-62070;

MACK: AT-00154R;

TOYOTA: 27060-03010, 27060-03011, 27060-15050, 27060-15060, 27060-46080, 27060-62070, 27060-74090, 27060-74110, 27060-74210, 27060-74270, 27060-74290, 27060-74291, 27060-74300, 27060-74310, 27060-74320, 27060-74330

NIPPONDENSO
GA840

FEATURES / CARACTERÍSTICAS: 14V , 'A' Circuit, Mounting 63,5 mm, Terminals: D-FR-IG-L, Terminal 'L' with drive choke

REPLACES / REEMPLAZA:

Nippondenso: 126000-0570; **Cargo:** 132831; **WAI/Transpo:** IN057

APPLICATION / APLICACIÓN:

HONDA: Acura, Civic, Integra.

ALTERNATOR / ALTERNATOR:

NIPPONDENSO: 1002111350, 1002111351, 1002111370, 1002113930, 1002117320, 1002117330; **LESTER:** 13326, 14759, 14853, 14854, 14930; **HONDA:** 3100PE7660, 31100P3003, 31100PE7660, 31100PE7661, 31100PG7013; **PIC:** 290201, 290203, 290214, 290214A, 290229

NIPPONDENSO
GA841

FEATURES / CARACTERÍSTICAS: 14V 'A' Circuit, 63.5 mm Mounting, Terminals: S-FR-IG-L, Terminal 'L' with drive choke

REPLACES / REEMPLAZA:

Nippondenso: 126000-0540, 126000-1170; **Regitar:** VRH2005-9A; **Cargo:** 132645; **WAI/Transpo:** IN226

APPLICATION / APLICACIÓN:

HONDA: Acura Legend, Honda Accord.

ALTERNATOR / ALTERNATOR:

NIPPONDENSO: 1002112010, 1002112130, 1002112140, 1002112550, 1002113310, 1002116150, 1002116170, 1002117070, 1002117240, 1002117500, 1002117810; **LESTER:** 13294, 13386, 13387, 14591, 14680, 14941; **HONDA:** 31000PH7013, 31100P98004, 31100PD6014, 31100PH30243, 31100PH3J01, 31100PH7013, 31100PH7024, 31100PHJ004, 31100PJ0663, 31100PJ0663, 31100PK20031, 31100PK2004, 31100PK20146, 31100PK20241, 31100PK3A011, 31100PK3A020M, 31100PP8004, 31100PY3003, C1K46.

NIPPONDENSO
GA842

FEATURES / CARACTERÍSTICAS: 14V 'A' Circuit, 63.5 mm Mounting, Terminals: D-FR-IG-L, Terminal 'L' with drive choke

REPLACES / REEMPLAZA:

Nippondenso: 126000-1470, 126000-1471; **Regitar:** VRH2005-19; **WAI/Transpo:** IN429

APPLICATION / APLICACIÓN:

HONDA: Acura Integra

ALTERNATOR / ALTERNATOR:

NIPPONDENSO: 1002118910, 1002119100, 1002118911; **PIC:** 290283; **HONDA:** 31100PRRC01; **LESTER:** 13433

NIPPONDENSO
GA843

FEATURES / CARACTERÍSTICAS: 14V 'A' Circuit, 63.5 mm Mounting, Terminals: C-FR-IG-L, Terminal 'L' with drive choke

REPLACES / REEMPLAZA:

Nippondenso: 126000-1410, 126000-1860, 126000-1880; **Regitar:** VRH2005-10; **Cargo:** 132859; **WAI/Transpo:** IN431

APPLICATION / APLICACIÓN:

HONDA: Prelude.

ALTERNATOR / ALTERNATOR:

NIPPONDENSO: 1002118740, 1012115480, 1002119770, 1012115490, 1012110250, 1012115500, 1012115410, 1012115850, 1012115420, 1012115890, 1012115430; **PIC:** 290327, 290486, 290490, 290491; **HONDA:** 31100POAA0030, 31100P130130, 31100P130133, 31100P390030, 31100POA0030, CJP75, CJQ21; **LESTER:** 13506, 13509, 13529, 13538, 13539

NIPPONDENSO
GA844

FEATURES / CARACTERÍSTICAS: 14V 'A' Circuit, 63.5 mm Mounting, Terminals: C-FR-IG-L, Terminal 'L' without drive choke

REPLACES / REEMPLAZA:

Nippondenso: 126000-1360; **Regitar:** VRH2005-22; **WAI/Transpo:** IN433

APPLICATION / APLICACIÓN:

HONDA: Civic 1.6L

ALTERNATOR / ALTERNATOR:

HONDA: 31100-P30-023, 31100-P30-G02, 31100-P30-G03, 31100-P30-G04, CJP93

NIPPONDENSO: 1002118600

NIPPONDENSO
GA845

FEATURES / CARACTERÍSTICAS: 14V 'A' Circuit, 63.5 mm Mounting, IG-L, Terminal 'L' with drive choke

REPLACES / REEMPLAZA:

Nippondenso: 126000-1060; **Regitar:** VRH2005-9A; **Cargo:** 132645; **WAI/Transpo:** IN444

APPLICATION / APLICACIÓN:

HONDA: Acura Legend, Sterling 825, Sterling 927

ALTERNATOR / ALTERNATOR:

HONDA: 31100PH7004, 31100PP8014; **LESTER:** 14931; **STERLING:** 86186100067

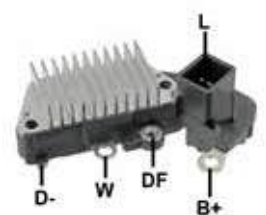
NIPPONDENSO
GA862

FEATURES / CARACTERÍSTICAS: 14V, 120A 'A' Circuit, 63,5 mm, Terminal L

REPLACES / REEMPLAZA:

Nippondenso: 1260001130, 1260001760, 1260002791; **Regitar:** VRH2005-34; **Cargo:** 136727; **WAI/Transpo:** IN442

APPLICATION / APLICACIÓN:

VOLVO: S40 Sallon 1995-2003, V40 Estate 1995-2004, S70 /V70 1996-2001

ALTERNATOR / ALTERNATOR:

DENSO: 1022110500

NIPPONDENSO
GA865

FEATURES / CARACTERÍSTICAS: 14V, 'A' Circuit, 63,5 mm

REPLACES / REEMPLAZA:

Nippondenso: 126000-1810, 126000-1850, 126000-1870, 126000-2000, 126000-2260; **Regitar:** VRH2005-63A; **Cargo:** 138894; **WAI/Transpo:** IN441

APPLICATION / APLICACIÓN:

TOYOTA: Camry, Lexus;

MAZDA: Millenia 2.5L

ALTERNATOR / ALTERNATOR:

NIPPONDENSO: 101211-5450, 101211-5560, 101211-5620, 101211-5650, 101211-5710, 101211-7020, 101211-7070, 101211-7090, 101211-7091, 101211-7120, 101211-7170, 101211-7240, 101211-7520, 101211-7670, 101211-7750, 101211-7800, 101211-7840, 101211-9060, 101211-9100, 101211-9160, 101211-9350, 101211-9410, 101211-9600, 101211-9710, 101211-9711, 101211-9780, 102211-0590, 102211-0650, 102211-0730, 102211-1620, 102211-1900, 102211-1920, 102211-1990, 102211-2000, 102211-2001, 102211-2350, 102211-2351; **PIC:** 290-5048

NIPPONDENSO
GA866

FEATURES / CARACTERÍSTICAS: 14V, 'A' Circuit

REPLACES / REEMPLAZA:
Denso: 1260002190, 1260002450; **Honda:** 31150P5A003, 31150P5G003, 31150P5A0030, 31150P5G0030; **Regitar:** VRH2005-64A; **Cargo:** 236768, 233517; **WAI/Transpo:** IN455; **Mobiletron:** VR-H2005-64A; **AS Poland:** ARE6027

APPLICATION / APLICACIÓN:
ACURA: RL V6 3.5L 3475cc 1996~2004

ALTERNATOR / ALTERNATOR:
DENSO: 101211723, 101211727, 1012117230, 2100204; **HONDA:** 31100P5A003, 31100P5G013, 31100P5A003RM, 31100P5G01301; **ACURA:** 31100P5G013RM, CLB54, CLB58; **DELPHI:** RM4063

NIPPONDENSO
GA885 // NEW //

FEATURES / CARACTERÍSTICAS: 14V, 'B' Circuit

REPLACES / REEMPLAZA:
Denso: 126600-0520, 126600-0540; **Toyota:** 27700-21050, 27700-75030; **Transpo:** IN3054; **Mobiletron:** VRH-2005-100A; **Regitar:** VRH2005-100A

APPLICATION / APLICACIÓN:
TOYOTA: Tacoma L4 2.7L 2005>2010, Yaris L4 1.5L 2006>2009, Yaris L4 1.5L 2010>2015

ALTERNATOR / ALTERNATOR:
DENSO: 104210-8110, 104210-8180, 104210-8230, 104210-8232, 104210-8400, 104210-8401, 104210-8590, 104210-8591;

TOYOTA: 27060-21150, 27060-21151, 27060-21151, 27060-75310, 27060-75310-84, 27060-75410, 27060-75411, 27060-75411-84, 27060-75412, 27060-75490, 27060-75490

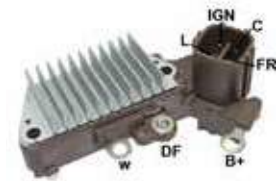
NIPPONDENSO
GA891

FEATURES / CARACTERÍSTICAS: 14V, 'A' Circuit

REPLACES / REEMPLAZA:
Nippondenso: 1260003430; **Transpo:** IN343; **Regitar:** VRH2005-40A; **Mobiletron:** VR-H2005-40A; **Cargo:** 333764; **AS-Poland:** ARE6094

APPLICATION / APLICACIÓN:
JAGUAR: X-Type V6 2.5, 3.0 2002>2004, X-Type 2000 V6 2001>2006, X-Type 3000 V6 2001>2006

ALTERNATOR / ALTERNATOR:
Nippondenso: 1022110860, 1022110870

NIPPONDENSO
GA870

FEATURES / CARACTERÍSTICAS: 14V 'A' Circuit, 57.5 mm Mounting, Terminals: IG-L, Terminal 'L' without drive choke

REPLACES / REEMPLAZA:
Nippondenso: 126000-0600, 126000-0760, 126000-1160; **Regitar:** VRH2005-39; **Cargo:** 133872; **WAI/Transpo:** IN254

APPLICATION / APLICACIÓN:

Forklifts and other industrial applications.

ALTERNATOR / ALTERNATOR:
NIPPONDENSO: 1002111511, 1002111540, 1002111550, 1002111580, 1002111590, 1002111610, 1002111630, 1002111650, 1002111680, 1002111690, 1002114050, 1002114060, 1002114080, 1002114091, 1002114180, 1002114200, 1002114200, 1002114220, 1002114230, 1002114240, 1002114250, 1002114360, 1002114382, 1002111670, 1002114460, 1002114482, 1002114520, 1002114550, 1002114560, 1002114700, 1002116221, 1002111662, 1002116640, 1002116760, 1002116770, 1002116880, 1002116890, 1002116900, 1002116920; **PIC:** 290208

NIPPONDENSO
GA872

FEATURES / CARACTERÍSTICAS: 14V 'A' Circuit, 57.5 mm Mounting, Terminals: IG-L, Terminal 'L' with drive choke

REPLACES / REEMPLAZA:
Nippondenso: 126000-0970; **Regitar:** VRH2005-15; **Cargo:** 133519; **WAI/Transpo:** IN255

APPLICATION / APLICACIÓN:

Forklifts and other industrial applications.

ALTERNATOR / ALTERNATOR:
NIPPONDENSO: 1002111630, 1002111660, 1002111670, 1002114000, 1002114003, 1002114020, 1002114080, 1002114390, 1002114640, 1002114650, 1002116780; **LESTER:** 12179, 12180, 12182, 12189, 12190, 12196, 12198, 12199, 12204, 12207; **PIC:** 290179, 290190, 290193, 290194, 290197, 290198, 290199, 290205, 290209, 290439, 290907, 902087; **TOYOTA:** 1588164201, 2706078001, 2706078301, 2706087504; **KUBOTA:** 1588164200, 1623164011, 1654164011, 1670564011, 1677164012; **ISHIHAWAJIMA:** 185046220; **THERMOKING:** 5D36221G01

NIPPONDENSO
GA895

FEATURES / CARACTERÍSTICAS: 14V, 'A' Circuit

REPLACES / REEMPLAZA:
Nippondenso: 126000-1970, 126000-1971, 126000-2500, 126000-2740, 126000-3400; **Suzuki:** 3250077E10, 3250060G10; **Transpo:** IN452; **Regitar:** VRH2005-48A; **Mobiletron:** VR-H2005-48A; **Cargo:** 139268; **AS-Poland:** ARE6057

APPLICATION / APLICACIÓN:
SUZUKI: Baleno hatch/saloon/estate 1.3/1.6/1.8 1995>2002, Grand Vitara Mk1 2.5 V6 1998>2003, Jimny 1.3 16v 1998>, Wagon R+ 1.0 1998>2000

ALTERNATOR / ALTERNATOR:
NIPPONDENSO: 101211055, 101211072, 101211520, 102211502, 102211507, 102211528, 1042108121, 1002132530

NIPPONDENSO
GA897 // NEW //

FEATURES / CARACTERÍSTICAS: 14V, 'A' Circuit

REPLACES / REEMPLAZA:

DENSO: 126000-1770; Transpo: IN277; AS-Poland: ARE6035

APPLICATION / APLICACIÓN:

MARINER ENGINE MARINE: 225 (Carb) GM 3.0L - 183ci - 6cyl 0000, 225 (EFI) GM 3.0L - 183ci - 6cyl 0000, 225 SEA PRO (Carb) GM 3.0L - 183ci - 6cyl 0000, 250 (EFI) GM 3.0L - 183ci - 6cyl 0000, 300CL Promax Racing 3.0L - 185.0ci - 300 H.P. 1998>2000, 300XL Promax Racing 3.0L - 185.0ci - 300 H.P. 1998>2000

ALTERNATOR / ALTERNATOR:

DENSO: 101211-3020, 101211-3021; MERCURY MARINE: 821663, 821663-1, 821663-A1

NIPPONDENSO
GA875

FEATURES / CARACTERÍSTICAS: 14V 'A' Circuit, 86 mm Mounting, Terminals: IG-L-S

REPLACES / REEMPLAZA:

Nippondenso: 126000-0360, 126000-0460, 126000-0500, 126000-0670; Toyota: 27700-63030, 27700-72050; Regitar: VRH2005-28; WAI/Transpo: IN235

APPLICATION / APLICACIÓN:

TOYOTA: Corolla, Landcruiser; HINO

ALTERNATOR / ALTERNATOR:

NIPPONDENSO: 1002110680, 1002110730, 1002110731, 1002110760, 1002110761, 1002110780, 1002110870, 1002110930, 1002110931, 1002112570, 1002112630, 1002112980, 1002112990, 1002115760, 1002115930, 1210003380; LESTER: 14461, 14672; HINO: 270401240A, 270 401261A; TOYOTA: 290309, 2706016030, 2706061090, 2706063070, 2706072020, 2706072030, 2706072040

NIPPONDENSO
GA902

FEATURES / CARACTERÍSTICAS: Capacitor 2,2uF 250V

REPLACES / REEMPLAZA:

Mobiletron: TB-ND160; Regitar: TB-ND160

APPLICATION / APLICACIÓN:

Dodge: Dakota, Durango and RAM 2002>;

Jeep: Cherokee, Gran Cherokee, Liberty 3.7 V6 2002>

ALTERNATOR / ALTERNATOR:

NIPPONDENSO: 1210004540, 56027913AB, TN1210004290, 56041693A

NIPPONDENSO
GA448

FEATURES / CARACTERÍSTICAS: 24V, 'A' Circuit, Terminals NF-IG-L

REPLACES / REEMPLAZA:

Caterpillar: 185-2648; Denso: 126000-2540; WAI/Transpo: IN9254; AS Poland: ARE6105

APPLICATION / APLICACIÓN:

Caterpillar: Heavy and Medium Trucks.

ALTERNATOR / ALTERNATOR:

Caterpillar: 1693345, 1855294, 1978820, 2267683; Denso: 101211-813, 101211-814, 101211-827, 101211-830, 101211-831, 101211-834, 101211-840

RECTIFIER:

GA1316

NIPPONDENSO
GA449

FEATURES / CARACTERÍSTICAS: 14V, 'A' Circuit, Terminals: S, L e IG

REPLACES / REEMPLAZA:

Nippondenso: 126000-0920, 126000-1460, 126000-1421

APPLICATION / APLICACIÓN:

Hino: FA14, FA15, FB14, FB15, FC W06D

ALTERNATOR / ALTERNATOR:

Hino: 27020-1290A, 27020-1810A, 27020-1811A, 27040-1290, 27040-1290A, 27050-1290; Isuzu: 8-97940-220-0;

Toyota: 27020-64210, 27020-64211, 27020-64220, 27020-64221, 27040-64130, 27040-64131, 27040-64140, 27040-64141

NIPPONDENSO
GA498

FEATURES / CARACTERÍSTICAS: 28V 'A' Circuit

REPLACES / REEMPLAZA:

Denso: 7T2798, 126000-0380; Cargo: 231060; WAI/Transpo: IN233; AS Poland: ARE6046

APPLICATION / APLICACIÓN:

CATERPILLAR

ALTERNATOR / ALTERNATOR:

DENSO: 6T7223, 100211-086

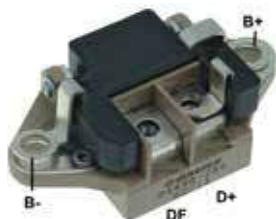

NOSSO
GA111

FEATURES / CARACTERÍSTICAS: 14V, 'A' Circuit

REPLACES / REEMPLAZA:

Nashville: 2114000000

APPLICATION / APLICACIÓN:

Heavy Duty Vehicles 12V

ALTERNATOR / ALTERNATOR:

BOSCH

NOSSO
GA112

IG W DF



FEATURES / CARACTERÍSTICAS: 14V, 'A' Circuit

REPLACES / REEMPLAZA:

Toyota: 2770072030; Cargo: 132627; WAI/Transpo: IN589

APPLICATION / APLICACIÓN:

TOYOTA: Corolla 1.6 1983, Tercel 1.5 83>88, Hilux Pick up 4x4 96>

ALTERNATOR / ALTERNATOR:

TOYOTA: 27020-15100, 27020-15110, 27020-15120, 27020-15121, 27020-15122

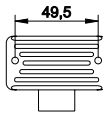
POONG SUNG
GA125

FEATURES / CARACTERÍSTICAS: 14V / 65A, 'A' Circuit

REPLACES / REEMPLAZA:

Poong Sung: 121500-0011; Regitar: K01; WAI/Transpo: PG101, PG133; Regitar: VRK01; Mobiletron: VR-K01; WAI/Transpo: PG101; Cargo: 139469; PG133; AS Poland: ARE9023

APPLICATION / APLICACIÓN:

KIA: Besta, Topic.

ALTERNATOR / ALTERNATOR:

POONG SUNG: OK 74 018 300 H

RECTIFIER:

GA1126

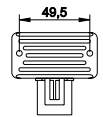
POONG SUNG
GA126

FEATURES / CARACTERÍSTICAS: 14V / 90A, 'A' Circuit

REPLACES / REEMPLAZA:

Poong Sung: 0K72A24520; Regitar: VRK02; WAI/Transpo: PG102

APPLICATION / APLICACIÓN:

KIA: Besta GS.

ALTERNATOR / ALTERNATOR:

POONG SUNG: OK 72 A18 300

RECTIFIER:

GA1126 / GA1135

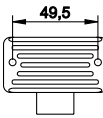
POONG SUNG
GA127

FEATURES / CARACTERÍSTICAS: 28V / 65A, 'A' Circuit

REPLACES / REEMPLAZA:

WAI/Transpo: PG103

APPLICATION / APLICACIÓN:

KIA: Pick-up's Diesel 2700, 3500

ALTERNATOR / ALTERNATOR:

POONG SUNG: 28V

POONG SUNG

GA128

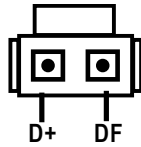

FEATURES / CARACTERÍSTICAS: 14V / 85A, 'A' Circuit

REPLACES / REEMPLAZA:

Poong Sung: OK054-18-300A; **Cargo:** 235035; **WAI/Transpo:** PG104

APPLICATION / APLICACIÓN:

KIA: Carnival 2.9 TDi 16V 1999>

ALTERNATOR / ALTERNATOR:

POONG SUNG: 02131-9040; **KIA:** OK552-18-300B

POONG SUNG

GA589



FEATURES / CARACTERÍSTICAS: 14V, 'A' Circuit

REPLACES / REEMPLAZA:

Hyundai / Kia: 37370-27011; **Cargo:** 235522; **AS-Poland:** ARE2058; **Transpo:** IH711; **Mobiletron:** VR-K05; **Regitar:** K05

APPLICATION / APLICACIÓN:

HYUNDAI EUROPE CAR: Elantra 2000 2002>2004, Santa Fe 2000 2001>2010, Trajet 2000 2001>2007

HYUNDAI EUROPE TRUCK: Tucson 2000 2004>2010

KIA EUROPE CAR: Carens 2000 2002>2006, Sportage 2000 2004>2010

ALTERNATOR / ALTERNATOR:

Hyundai/ **Kia:** 37300-27010, 37300-27012, 37300-27020, 37300-27021, 37300-27030, 37300-27031

PRESTOLITE

GA590



FEATURES / CARACTERÍSTICAS: 14V, 'A' Circuit

REPLACES / REEMPLAZA:

Motorola: 5-265;

Transpo: M5-265;

Prestolite: 105-265;

Thermoking: 44-7322

APPLICATION / APLICACIÓN:

CUMMINS, MERCURY, JOHN DEERE, Thermo King Misc. Equipment: Sentry 30 di / TC 1983-1988, Super II 30 / MAX 1983-1988

ALTERNATOR / ALTERNATOR:

Cummins: 3675146RX, 3675147RX;

Mercury Marine: 17399; **Prestolite:** 110-231, 110-345, 110-346, 110-354, 110-355, 110-372, 110-380, 110-382, 110-386, 110-387, 110-389, 110-393, 110-395, 110-686

PRESTOLITE

GA591



FEATURES / CARACTERÍSTICAS: 14V, 'A' Circuit

REPLACES / REEMPLAZA:

Motorola: 5-276; **Transpo:** M5-276;

Prestolite: 105-276; **Thermoking:** 44-7928

APPLICATION / APLICACIÓN:

THERMOKING: 1974>2005; **Misc. Equipment:** Sentry 30 di / TC 1983-1988, Super II 30 / MAX 1983-1988

ALTERNATOR / ALTERNATOR:

Prestolite: 110-231, 110-393, 110-399, 110-400;

Cummins: 3675146RX, 3675147RX;

Motorola: 10-231, 10-393, 10-399, 10-400, 8EK2003FA, 8EK2003FB, 8EK2003FC;

Thermoking: 2D72786G03, 2D72787G02, 3D97386G01, 3D97386G02, 3D97386G03

PRESTOLITE

GA595

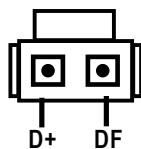

FEATURES / CARACTERÍSTICAS: 14V, 'A' Circuit

REPLACES / REEMPLAZA:

-

APPLICATION / APLICACIÓN:

PEUGEOT: 306, 405

VW: Gol 1.6/ 1.8/ 2.0 1998>2002

FORD: Escort Zetec 1.6, Ranger

ALTERNATOR / ALTERNATOR:

Prestolite: 35381935, 35215163, 35214945E, 35382080, 32525150

PRESTOLITE
GA596

FEATURES / CARACTERÍSTICAS: 14V, 'A' Circuit

REPLACES / REEMPLAZA:

Prestolite: 35382000, 35382110, 35215163, K01427, K01206

APPLICATION / APLICACIÓN:

VW: Gol 2001>2002, Parati, Santana

ALTERNATOR / ALTERNATOR:

Prestolite: 35214500C, 35214505B, 35214535B, 35214545B, 35214525B, 35214530C, 35214540C, 35214555B, 35214565B, 35214575B.

PRESTOLITE
GA597

FEATURES / CARACTERÍSTICAS: 14V, 'A' Circuit

REPLACES / REEMPLAZA:

Prestolite: K01390, 35381770, 35214592

APPLICATION / APLICACIÓN:

RENAULT: Clio Full Diesel, Clio Full Nafta, Express Diesel, Clio MK1 hatch 1.8/1.9, Espace MK1 2.0, R9 Saloon 1.7, R19 MK1 hatch 1.7, R19 MK1 Saloon 1.7, R19 MK1 Convertible 1.7, R21 hatch 1.7, R21 Saloon 1.7, R21 Savanna Estate 1.7;

DAIHATSU: Minibus c/ motor Cummins

ALTERNATOR / ALTERNATOR:

Prestolite: 35214420, 35214420A, 35214080, 35214180

RECTIFIER:

GA1597

PRESTOLITE
GA598

FEATURES / CARACTERÍSTICAS: 14V, 'A' Circuit

REPLACES / REEMPLAZA:

Prestolite: K01426, 35382090, 35381865, 35381940, 35215163

APPLICATION / APLICACIÓN:

VW: Gol III, Parati III, Saveiro III

ALTERNATOR / ALTERNATOR:

Prestolite: 35214195, 35214410D

PRESTOLITE
GA592 // NEW //

FEATURES / CARACTERÍSTICAS: 14V, S. POINT: 13,7V - 16,0V, 'B' Circuit

REPLACES / REEMPLAZA:

Motorola: 5-237, 8RG2026, 8RG2029; **Thermoking:** 44-8995; **Prestolite:** 105-237; **Volvo:** 862539; **Ford:** F3HZ-10316-B; **Transpo:** M5-237A

APPLICATION / APLICACIÓN:

MASSEY FERGUSON: MF-8350 Cummins 6-505 1995>1997, MF-8570 Cummins 6-505 1993>1997, MF-9720 DD 8-640 Diesel 1993, MF-9790 Cummins QSL 2003>2006;

AGCO GLEANER COMBINE: R65 Cummins 6C 2004>2007;

CHAMPION GRADER: 760 DD 6-71 1982>1991;

VERMEER TRENCHER: T655 Cat. 3116 DITA 1995>2007, T655DT Cat. 3116 DITA 1995>2007, T755 Cat. 3116 DITA 1995>2007, T758 Cat. 3306C 1995>2007

ALTERNATOR / ALTERNATOR:

Prestolite: 110-255, 110-320; **Motorola:** 10-255, 10-320, 8LHA2023, 8LHA2023V, 8LHA2023VB, 8SA2023VA, 8SA2035V, 8SA2035VA, 8SA2035VAS; **DELCO:** 10459555

PRESTOLITE
GA604

FEATURES / CARACTERÍSTICAS: 28V, 'A' Circuit

REPLACES / REEMPLAZA:

Prestolite: AVE2119-E;

Cummins: 5263830;

Agrale: 6025.001.175.00.0

APPLICATION / APLICACIÓN:

VALDAY: Russian Truck

ALTERNATOR / ALTERNATOR:

Agrale: 6025.001.175.00.0; **Prestolite:** AVE 2119 E; **Cummins:** 5263830, 5263797

PRESTOLITE

GA605



FEATURES / CARACTERÍSTICAS: 14V, 'A' Circuit

REPLACES / REEMPLAZA:

Prestolite/ Thermoking: 41-1740

Motorola: 105-335, 8RG2060, 8RG2060A, 8RG2060AS, 8RG2060S

APPLICATION / APLICACIÓN:

THERMO KING TRAILER UNIT: HK, HK-II, HK-III TK 2.49 Diesel 0000, SB-III Isuzu 2.0/2.2 Diesel 0000, Sentry Isuzu 2.2L Dsl 0000, Super II MAX Isuzu 2.2L Dsl 0000, TD-II Yanmar 388 Diesel 0000

THERMO KING TRUCK UNIT: KD-II Yanmar 366 Diesel 0000, KD-II MAX Yanmar 366 Diesel 0000, KD-II SR Yanmar 374 Diesel 0000, MD-200 Yanmar 374 Diesel 0000, MD-200-MT Yanmar 374 Diesel 0000, MD-300 Yanmar 374 Diesel 0000, MD-II Yanmar 366 Diesel 0000, MD-II MAX Yanmar 374 Diesel 0000, MD-II MAX SR Yanmar 374 Diesel 0000, MD-II SR Yanmar 374 Diesel 0000, MD-II TCI Yanmar 366 Diesel 0000, RD-II Yanmar 388 Diesel 0000, RD-II MAX Yanmar 388 Diesel 0000, RD-II MAX SR Yanmar 388 Diesel 0000, TS-200 Yanmar 374 Diesel 0000, TS-300 Yanmar 374 Diesel 0000, TS-500 Yanmar 395 Diesel 0000, TS-600 Yanmar 395 Diesel 0000 XDS 0000

ALTERNATOR / ALTERNADOR:

Thermoking: 10-41-2194, 10-41-2195, 10-41-2196, 10-41-2197, 10-41-2198, 10-41-2199, 10-41-2200, 10-41-2201, 20-41-2195, 20-41-2198, 20-41-2200, 41-2194, 41-2195, 41-2196, 41-2197, 41-2198, 41-2199, 41-2200, 41-2201, 41-2705, 45-1706, 45-1706, 5D44463G01, 5D44464G01, 5D44465G02, 5D44466G01, 5D44466G03, 5D44467G0, 5D44467G01, 5D46047G01, 5D51051G01, 5D51051G02

RECTIFIER:

GA1593

PRESTOLITE

GA606 // NEW //



FEATURES / CARACTERÍSTICAS: 14V, 'A' Circuit

REPLACES / REEMPLAZA:

Thermoking: 41-8851; **Magneton:** 0170750; **Transpo:** MP300

APPLICATION / APLICACIÓN:

THERMOKING: SBIII, SENTRY SUPER II, SB200, SB210, SB230, SB310, SB330

THERMOKING GENERATOR: APU TriPac TK270 Engine 0000

YANMAR ENGINES - INDUSTRIAL: 2TNV70 0000

ALTERNATOR / ALTERNADOR:

THERMOKING: 1E32215G01, 1E51760G01, 1E32216G01, 1E32216G02, 1E32217G01, 1E51760G0, 41-6780, 41-6781, 41-6782, 41-6990, 41-8464, 45-2592, 45-6780, 841-8464; **MAGNETON:** 1E32216G02, 1E53365G02, 9515.593

PRESTOLITE

GA609 // NEW //

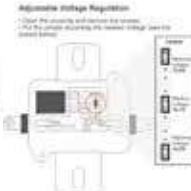

FEATURES / CARACTERÍSTICAS: 14V, 'B' Circuit

REPLACES / REEMPLAZA:

Prestolite: 8-724, SRP-1373; **Chrysler:** 1889960, 2095700, 2098300, 3000074, CH-524, CH-531; **Transpo:** C8010; **Mobiletron:** VR-C524; **Regitar:** C524

APPLICATION / APLICACIÓN:

DODGE MEDIUM/HEAVY TRUCK: All Models (By Engine) All Engines 1960>1969

EATON LIFT TRUCK: Various Models Ford 260/289/390/427 Engine 1966>1972

STUDEBAKER CAR: Challenger L6 2.8 1964, Commander L6 2.8 1964, Cruiser L6 2.8 2780 1964, Daytona L6 2.8 1964, Gran L6 2.8 1963>1964, Lark L6 2.8 1963, Wagonaire L6 3.2 1966

ALTERNATOR / ALTERNADOR:

CATERPILLAR: 84713, 926261; **CHRYSLER:** 2095000, 2095060, 2095100, 2095300, 2095425, 2095661, 2095663, 2095666, 2095667, 2098260, 2098262, 2098265, 2098268, 2098270, 2098275, 2098285, 2098320, 2098325, 2098525, 2098530, 2098535, 2098830, 2098835, 2098840, 2098850, 2098850, 2098860, 2098870, 2098875, 2098880, 2444347, 2444437, 2444599, 2444897, 2444898, 2444899, 2444900, 2642121, 2642487, 2642537, 2642538, 2642630, 2642635, 2642638, 2642944, 2875437, 2875439, 2875442, 2875453, 2875549, 2875712, 2875713, 2875720, 2875724, 2875844, 3000005, 3000010, 3438171, 3438172, 3438173, 3527125; **PRESTOLITE:** 51-10, 51-211, 51-32, 51-36, 51-37, 51-6, ALB5001, ALB5002, ALD5001, ALE5006, ALK5001, ALK5005A; **YALE:** 1294834, 2200507-11

VALEO - DUCELLIER

GA510



FEATURES / CARACTERÍSTICAS: 14V, 'B' Circuit

REPLACES / REEMPLAZA:

Valeo-Ducellier: 510 002, 510 004, 510 005, 519 001; **Regitar:** VR-DU510; **Cargo:** 130679; **WAI/Transpo:** ID4009

APPLICATION / APLICACIÓN:

PEUGEOT: 504 2.1L/ 1.3L, 604 2.3L; **RENAULT:** LeCar L4 1.4L

ALTERNATOR / ALTERNADOR:

VALEO: 2059913, 2070085, 2072015, 2072557, 2072860, 2072922, 2072983, 2074514, 2074683, 2075272, 2075809, 2075897, 2075973, 2076416, 2076633, 2076665, 2076979, 2077391, 2077421, 2077423, 2077579, 2077595, 2077720, 2077751, 2078545, 2078666, 2078689, 2078710, 2078728, 2078771, 2078848, 2078849

VALEO - DUCELLIER
GA957

FEATURES / CARACTERÍSTICAS: 14V, 'A' Circuit, Terminals: L, IGN, S, B+ LEADS

REPLACES / REEMPLAZA:

Citroën: 95546007; **Fiat/Marelli:** 940038046; **Lucas:** 21220253, 21220353, UCB206, UCB207; **Peugeot:** 576146, 576163, 95546007, 7701024524, 7701027713, 7701030069; **Valeo:** 511006, 511008, 511010, 511022, 511024, 581255, 581256, 590681, 690012, 690587, 690645, 690686, 691097, 691253, 691292, 691428, 691468, 691486, 691532, NB982;

APPLICATION / APLICACIÓN:

RENAULT: 18, WITH DUCELLIER 12V ALTERNATOR, DeLorean, Renault (1987-80)

ALTERNATOR / ALTERNATOR:

VALEO: 514011, 514011A, 514011B, 514011BC, 514011C, 514011D, 514012, 514012A, 514012ABCD, 514012BC, 514012C, 514012D, 516006, 516006A, 516006B, 516006C, 516006D, 516006E, 516007, 516007A, 516007ABCD, 516007B, 516007BCD, 516007C, 516007D, 516008, 516008A, 516008ABCD, 516009, 516009A, 516009ABC, 516009B, 516009BC, 516009C, 516013, 516013A, 516013B, 516013C, 516015, 516015A, 516016, 516016A, 516016AB, 516016B, 516017, 516017A, 516017AB, 516017B, 516020, 516020A, 516020ABCD, 516020B, 516020C, 516020CD, 516020D, 516023, 516023A, 516023B, 516023C, 516023CD, 516023D, 516024, 516024A, 516024B, 516024CD, 516025, 516025A, 516025B, 516025C, 516026, 516026A, 516026AB, 516026B, 516029, 516029A, 516029AB, 516029B, 516030, 516030C, 516030CD, 516030D, 516030DE, 516030E, 516033, 516033A, 516033B, 516033C, 516034, 516034AB, 516035, 516035A, 516035B, 516035C, 516037, 516037A, 516037B, 516037BC, 516037C, 516038A, 516038BC, 516042, 516042A, 516042ABC, 516044, 516044A, 516044BC, 516045, 516045ABC, 516047, 516047A, 516048, 516048AB, 516049, 516049AB, 516050A, 516057AB, 516058, 516058A, 516062, 516062A, 581207, 581207A, 581207B, 581207C, 581207D, 581208, 581208A, 581208B;

VALEO
GA060 // NEW //

FEATURES / CARACTERÍSTICAS: 14V, 'A' Circuit

REPLACES / REEMPLAZA:

Mobiletron: VR-VW009; **AS-Poland:** ARE3053; **Era:** 215835; **Transpo:** M509

APPLICATION / APLICACIÓN:

MERCEDES-BENZ: 300D L5 2.5L Diesel 1992>1993, 190 2000 1984>1990, 190D 2000 1985>1992, 190E 1800 1990>1993, 200 2000 1985>1992, 230E 2300 1985>1992, 250D 2500 1986>1993, 260E 2600 1985>1989, 300CE 3000 1987>1989, 300SL 3000 1986>1989, 609D 4.0L 1994>2001, 611D 4.0L 1994>2001, 711D 4.0L 1994, 809 4.0L 1986>2001, 811 4.0L 1994

ALTERNATOR / ALTERNATOR:

MERCEDES-BENZ: 0081546708, 0081548702, 0081548902;

VALEO: 2518044, 2518046, 2541297, A13V02, A13V05, A13V07

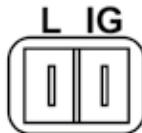
VALEO
GA293

FEATURES / CARACTERÍSTICAS: 14 Volt, A-Circuit; Terminals B+, D+, D-, DF, IG and L

REPLACES / REEMPLAZA:

Cargo: 237153; **Valeo:** 13480351, 237153

APPLICATION / APLICACIÓN:

KIA: Picanto 1.0; **HYUNDAI:** iX35 08/09>, Atos 08/99>, Sonata 05/12>

ALTERNATOR / ALTERNATOR:

VALEO: 2655517; **KIA:** 37300-02551; **HYUNDAI:** 37300-02551

RECTIFIER:

GA1887

VALEO
GA593

FEATURES / CARACTERÍSTICAS: 14V, 'A' Circuit

REPLACES / REEMPLAZA:

Valeo: 2519690, 2541407, 592802, NC989, YV1668H, YV1868H, 592802; **Transpo:** M512HD; **Cargo:** 135513

APPLICATION / APLICACIÓN:

RENAULT: Twingo Mk1 hatch 1.2 1993>1996

ALTERNATOR / ALTERNATOR:

VALEO: A11VI29, A13V113, A13V128, A13V130, A13V152, A13V113, A13V128, A13V130, 2541306, 2541325, 2541359H, 2541463, 436382, 436402, 2545469

RENAULT: 7700847513, 7700860601, 7701352300

VALEO
GA594

FEATURES / CARACTERÍSTICAS: 14V, 'B' Circuit

REPLACES / REEMPLAZA:

Valeo: 20071017, 20080622; **Transpo:** M563

APPLICATION / APLICACIÓN:

KIA: Sorento 3.3/3.5 V6 2002>2007, XG 30 1998>2005, XG 350 2002>2005

HYUNDAI: Terracan 3.5 i V6 2001>2008, Opirus 3.5 2003>

ALTERNATOR / ALTERNATOR:

VALEO: A0002655011, A0002655045, A0002655438

HYUNDAI/KIA: 37300-39400

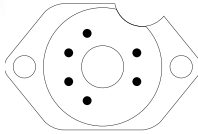
VALEO
GA905

FEATURES / CARACTERÍSTICAS: 14V, 'B' Circuit

REPLACES / REEMPLAZA:

Valeo: 593505, 593534, 593477, YR6604; **Regitar:** VRPR3534; **Cargo:** 234115; **WAI/Transpo:** M551; **Magneti Marelli:** RT510255

APPLICATION / APLICACIÓN:

FIAT: Dobló 1.8 OHC I 03 >, Dobló 1.8 SOHC, OHC I 01/01 >, Palio 1.8 OHC I 02 >, Stilo 1.8 03 >, Ducato 2.8 SOHC 03 >;
CHEVROLET: Novo Corsa, Sedan 1.0 02 >, Novo Corsa, Sedan 1.8 02 >, Meriva 1.8 02 >, Meriva 1.8 10/02 >, Corsa Sedan 1.0/ 1.0 16V, 1.6/ 1.6 16V 04 >, Corsa 1.0 8/ 16V 94 >, Novo Corsa 1.0/ 1.8, Sedan 02 >, Celta 1.0 OHC, VHC 00 >, Celta 1.4 VHC 00 >, Corsa Wagon 1.0, 1.0 16V, 1.6/ 1.6 16V 04 >, Corsa 1.4/ 1.6/ 1.6 16V 94 >, Corsa Pick up 1.6/ 1.6 16V 94 >.

ALTERNATOR / ALTERNATOR:

VALEO: 439512, 439513, 439517, 439519, 439520, 439522, 439514, SG10B024, SG10B034, SG12B048

RECTIFIER:

GA1808 / GA1825 / GA1830

VALEO
GA906

FEATURES / CARACTERÍSTICAS: 14V, 'B' Circuit

REPLACES / REEMPLAZA:

Valeo: 501405

APPLICATION / APLICACIÓN:

FORD: Focus 2.0, New Fiesta, Eco Sport Titanium

ALTERNATOR / ALTERNATOR:

Valeo: 2605459-A, TG12C108; **Ford:** AE8T-10300- BA

RECTIFIER:

GA1831

VALEO
GA907

FEATURES / CARACTERÍSTICAS: 14V, 'A' Circuit

REPLACES / REEMPLAZA:

-

APPLICATION / APLICACIÓN:

KIA: Picanto ex4 1.0 2012>2015

ALTERNATOR / ALTERNATOR:

Valeo: 2619399;

Kia/ Hyundai: 37300-04030, 37300-04010

RECTIFIER:

GA1892

VALEO
GA911

FEATURES / CARACTERÍSTICAS: 14V, 'B' Circuit

REPLACES / REEMPLAZA:

Valeo: 493811, 93312974, SG9B082; **Regitar:** VRPR1935; **WAI/Transpo:** M530; **Magneti Marelli:** RT510253

APPLICATION / APLICACIÓN:

FORD: Courier Zetec Rocam 1.0/ 1.6, EcoSport 1.0/ 1.6, Escort, SW 1.6 Zetec Rocam, Fiesta, Sedan 1.0/ 1.6 w/ AC, Novo Fiesta, Sedan 1.0/ 1.6 w/AC, KA 1.0/ 1.6 Zetec Rocam w/AC, Novo Fiesta, Sedan 1.0 Supercharger, EcoSport 1.0 Supercharger/ 1.6;

GM: Meriva 1.4 2008;

FIAT: Punto 1.8 2010, Palio 1.8, Idea 1.8, Stilo 1.8, Stilo Sporting 2007, Dobló 1.8

ALTERNATOR / ALTERNATOR:

VALEO: 439427, 439428, 93312974, SG9B051, SG9B056, SG9B082

RECTIFIER:

GA1809/ GA1810 / GA1815

VALEO
GA912

FEATURES / CARACTERÍSTICAS: 14V, 'B' Circuit

REPLACES / REEMPLAZA:

...

APPLICATION / APLICACIÓN:

Hyundai: i10 1.0 2013>, Creta 1.6 2017;

Kia: Picanto 1.0 2011>

ALTERNATOR / ALTERNATOR:

VALEO: 2619299, 2625573;

HYUNDAI: 37300-04635, 37300-04620, 37300-2B910, 2622971

RECTIFIER:

GA1812

VALEO
GA913

FEATURES / CARACTERÍSTICAS: 13,5V, 'B' Circuit

REPLACES / REEMPLAZA:

Valeo: 133421122, 20080710B, 2655544; **Regitar:** V5745; **WAI/Transpo:** M544

APPLICATION / APLICACIÓN:

KIA: Soul 2.0L;

HYUNDAI: I-30 2009>, Elantra 2.0 2007-2012

ALTERNATOR / ALTERNATOR:

VALEO: 2655635, 37300-23650; **HYUNDAI/ KIA:** 37300-25201

RECTIFIER:

GA1853

VALEO
GA914

FEATURES / CARACTERÍSTICAS: 14V, 'B' Circuit

REPLACES / REEMPLAZA:

Valeo: 2609955

BMW: 8510088-01

APPLICATION / APLICACIÓN:

BMW: 116d 2.0 2009>2011, 118d 2.0 2007>2011, 120d 2.0 2007>2011, 123d 2.0 2007>2011, 316d 2.0 2009>2011, 318d 2.0 2007>2011, 320d 2.0 2007>2011, 520d 2.0 2007>2010, 525d 2.0 2010>2016, 730d 3.0 2008>2015, 740d 3.0 2009>2015, X1 2.0 2009>2016, X3 2.0 2008>2016, X5 3.0 2008>2013, X6 3.0 2010>2014

ALTERNATOR / ALTERNATOR:

VALEO: FG18S019, TG15C093, 439545, 439613, 2543390, 254346; **BMW:** 12-31-7-799-180, 12-31-7-799-181, 12-31-7-802-26

VALEO
GA918

FEATURES / CARACTERÍSTICAS: 14V, 'B' Circuit

REPLACES / REEMPLAZA:

Valeo: 593796, 593873, 591901, 595200, 595265, 599101; **Transpo:** M545; **Cargo:** 236597, 335019; **Mobiletron:** VR-V3780; **AS-Poland:** ARE3034

APPLICATION / APLICACIÓN:

AUDI: A6 3.0 2005>2012, A6 3.0 TDI quattro 2006>2008, A6 2.7 TDI 2004>2008, A6 Allroad 3.0 TDI quattro 2006>2008, A6 Avant 3.0 TDI 2006>2008, A6 Avant 2.7 TDI 2005>2008, A8 3.0 TDI quattro 2003>2010, Q7 3.0 TDI quattro 2006>2008;

VOLKSWAGEN: Touareg 3.0 TDI 2006>2010, Touareg 3.0 V6 TDI 2004>2010;

BMW: Series 5: 520d 2005>2008, 523i 2004>2007, 525d 2004>2010, 530d 2005>2008, 535d 2004>2010 / Series 6: 635d 2007>2010 / Series 7: 730d 2002>2008, 730Ld 2005>2009, 730i 2005>2008

ALTERNATOR / ALTERNATOR:

VALEO: TG17C010, TG17C010B, TG17C048, 746135, TG17C011, TG17C048

VOLKSWAGEN/AUDI: 06C903016J

BMW: 12-31-7-788-821, 12-31-7-789-981, 12-31-7-789-984, 12-31-7-797-204-AI02, 12-31-7-797-521, 12-31-7-797-521-AI01, 12-31-7-797-522, 12-31-7-799-204, 12-31-7-802-929, 12-31-7-834-160, 12-31-7-836-592, 12-31-8-517-261

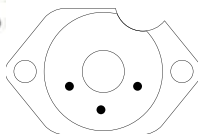
VALEO
GA920

FEATURES / CARACTERÍSTICAS: 14V, 'A' Circuit

REPLACES / REEMPLAZA:

Valeo: 493820; **Magnetit Marelli:** RT510252

APPLICATION / APLICACIÓN:

GM: Corsa 1.0 e 1.6 all with AC 94 >, Blazer/ S10 Gas 2.0 97 >, Astra 1.8, 2.0 16V, 2.0 99 >, Omega/ suprema 3.0/4.1 09/92 >, Vectra 2.0/2.2 8 and 16 V 93 >, Blazer/ S10 Diesel 2.8 00 >;

NISSAN: Nissan Frontier 2.8 TD MWM 10/02 >, Nissan X Terra 2.8 TD MWM 10/02 >;

TROLLER: Troller T4/T4M especial vehicles 10/02 >.

ALTERNATOR / ALTERNATOR:

VALEO: 439428, SG10B012, SG10B017, SG6S010; **CHEVROLET:** 93260364

RECTIFIER:

GA1823

VALEO
GA921

FEATURES / CARACTERÍSTICAS: 14V, 'B' Circuit

REPLACES / REEMPLAZA:

Regitar: VRPR5023; **Valeo:** 2655415, 2607089, 2655132, N0002655132; **Hyundai:** 37370-22650; **Transpo:** M535

APPLICATION / APLICACIÓN:

HYUNDAI: Tucson 2007>, Accent, Elantra 2006>;

KIA: Sportage, Cerato 90A 2004>

ALTERNATOR / ALTERNATOR:

VALEO: 2655023, 2455023, 2655474; **HYUNDAI:** 37300-22650; **CARGO:** 236224, **VALEO:** TG9S018

RECTIFIER:

GA1826

VALEO
GA922

FEATURES / CARACTERÍSTICAS: 14V, 'B' Circuit - Terminals B+, D-, DF, W, V, L. SETPOINT 14,4V

REPLACES / REEMPLAZA:

Valeo: 20051012, 2655001, 2655479; **Regitar:** V5001; **Cargo:** 235845; **WAI/Transpo:** M531

APPLICATION / APLICACIÓN:

HYUNDAI: Santa fé 200>2006, Sonata 1998>2005, Tiburon V 2.7 2003>, HB20 1.0 2012>2015; **KIA:** Magentis V6 2.7 2003>

ALTERNATOR / ALTERNATOR:

VALEO: 2655010; **HYUNDAI:** 37300-37400, 37300-2A500, 37300-37405, 37300-37800, 37300-04050; **KIA:** QK2AA-18-300, RK2AA-18-300U

VALEO
GA930

FEATURES / CARACTERÍSTICAS: 14V, 'B' Circuit, Terminal L

REPLACES / REEMPLAZA:

Valeo: 593529, 593857; **Regitar:** VRPR3529; **Cargo:** 234982; **WAI/Transpo:** M562; **Mobiletron:** VR-PR3529

APPLICATION / APLICACIÓN:

PEUGEOT: 207, 307

ALTERNATOR / ALTERNATOR:

TOYOTA: 27060-YV020, 27060-YV010; **VALEO:** A14VI40, SG15S017, TG15C020, TG15022, TG15023, TG15028, TG15053, TG15054, TG15060, TG15112, TG15118, TG15119, TG15127, TG15134, TG15154, TG15156, G15S031; **FIAT:** 9639396480, 71748885, 9646065480, 9646321780; **VALEO TECH:** 2542557, 2542938, 2543522, 2542928, 2542472, 2542693, 2542832, 2542924, 2543215; **LESTER:** 23227, 23231, 23301, 23908, 24079, 24080

RECTIFIER:

GA1820

VALEO
GA931

FEATURES / CARACTERÍSTICAS: 14V, 'B' Circuit

REPLACES / REEMPLAZA:

Valeo: 2655006, 20071017, 20080622; **Transpo:** M563; **Regitar:** VRPR5011; **Mobiletron:** VR-PR5011

APPLICATION / APLICACIÓN:

Kia: Sorento V6, Van Sedona V6 2003>2005

ALTERNATOR / ALTERNATOR:

Hyundai: 37300-39400, 37300-39435, 37300-39435RU, 37300-39450, 37300-39450RU

KIA: 37300-39435, 37300-39435R

VALEO
GA932

FEATURES / CARACTERÍSTICAS: 14V, 'B' Circuit

REPLACES / REEMPLAZA:

Valeo: 2650219, 2650348, 2650473; **Transpo:** M558; **Mobiletron:** VR-V0219

APPLICATION / APLICACIÓN:

GM: Malibu V6 2007>2010, Pontiac G6 V6 2008>2010 Saturn Aura 2007>2008

ALTERNATOR / ALTERNATOR:

VALEO: TG12C048, TG12C084, TG13S021

GM: 15237366, 25787949

VALEO
GA933

FEATURES / CARACTERÍSTICAS: 14V, 'B' Circuit

REPLACES / REEMPLAZA:

-

APPLICATION / APLICACIÓN:

KIA: Bongo K2500 2.5 CRDi 2013>;

HYUNDAI: HR 2013>

ALTERNATOR / ALTERNATOR:

Valeo: 2610454; **Kia/Hyundai:** 37300-4A700

RECTIFIER:

GA1885

VALEO
GA934 // NEW //

FEATURES / CARACTERÍSTICAS: 14V, 'B' Circuit

REPLACES / REEMPLAZA:

Valeo: 2542499; **Mobiletron:** VR-V2499; **Transpo:** M520; **AS-Poland:** ARE3043

APPLICATION / APLICACIÓN:

CHEVROLET: Corvette V8 6.0 2005>2007, Corvette V8 6.2 2008>2014, Corvette V8 7.0 2006>2013

ALTERNATOR / ALTERNATOR:

Valeo: TG15C140, TG15C046, TG15C089, TG15C107, TG15C139;

Chevrolet: 10327514, 15791160, 15841234, 25888970

VALEO
GA935

FEATURES / CARACTERÍSTICAS: 14V, 'B' Circuit

REPLACES / REEMPLAZA:
Elccor: ARG-PR0540E; **AS-Poland:** ARE3054; **Cargo:** 235657; **Transpo:** M561

APPLICATION / APLICACIÓN:
FIAT: Ducato Box 2.0 2002>2004, Scudo Box 2.0 16V 1999>2004, Ulysse 2.0 16V 1999>2002

CITROËN: Berlingo 2.0 2002>2005, C5 2.2 2001>2002, Evasion 2.0 16V 2000>2002, Jumper 2.0 2002>2007, Jumper 2.2 2002>2004, Xsara 2.0 1999>2002, Xsara Box 2.0 2000>2002, Xsara Break 2.0 1999>2002, Xsara Coupe 2.0 2001>2002

ALTERNATOR / ALTERNATOR:
Fiat: 9645907580, 9645907580

Citroën: 5702 A0 (P), 5702 A1 (C), 5702A0, 5702A1, 5705 4F, 5705 5H (P), 5705 5J (C), 5705 AA, 5705A1, 5705ER

Suzuki: 31400-68D01, 31400-68D01

VALEO
GA936

FEATURES / CARACTERÍSTICAS: 14V, 'A' Circuit

REPLACES / REEMPLAZA:
Valeo: 2542209B, 593333, 593347, YM2618; **Transpo:** M527; **Mobiletron:** VR-PR3617H; **Cargo:** 230944

APPLICATION / APLICACIÓN:
BMW: Series 3: 320i, 323i, 328i 1998>2005, Coupe/Cabriolet/Touring: 320 Ci, 323 Ci, 328 Ci 1999>2006, Series 5: Touring 520i, 523i, 528i 1997>2004, X5: 3.0i 2000>2006, Z3: 1.8i, 2.0i, 2.8i 1995>2003, Z3 Coupe 2.8 i 1996>2000

ALTERNATOR / ALTERNATOR:
Valeo: 436746, 439223, A13V1160

BMW: 12311432976, 12311432978, 12311432982, 12311432984

VALEO
GA939

FEATURES / CARACTERÍSTICAS: 14V, 'B' Circuit

REPLACES / REEMPLAZA:
Magneti Marelli: RT510256

APPLICATION / APLICACIÓN:
PEUGEOT: 206 1.6 16V 01 >;

CITROËN: XSARA Picasso 2.0L w/AC

ALTERNATOR / ALTERNATOR:
VALEO: 439521, 439515, SG12S051, SG9B043

RECTIFIER:

GA1811 / GA1832

VALEO
GA946

FEATURES / CARACTERÍSTICAS: 14V, 'B' Circuit

REPLACES / REEMPLAZA:

...

APPLICATION / APLICACIÓN:
TOYOTA: Etios XS 1.3/1.5 16V Flex 2011>

ALTERNATOR / ALTERNATOR:
VALEO: FG7T010; **TOYOTA:** 27060-0Y110

RECTIFIER:

GA1886

VALEO
GA949 // NEW //

FEATURES / CARACTERÍSTICAS: 14V, 'B' Circuit

REPLACES / REEMPLAZA:
Valeo: 593666; **Mobiletron:** VR-V3666; **Regitar:** V3666; **AS-Poland:** ARE3039; **Cargo:** 236306; **Transpo:** M574; **Era:** 216220

APPLICATION / APLICACIÓN:
RENAULT: Espace IV 1.9 dCI 2002>2006, Espace IV 2.0 Turbo 2002>2010, Espace IV 2.2 dCI 2002>2010, Grand Scenic II 1.9 dCI 2004>2010, Megane II 1.9 dCI 2002>2010, Scenic II 1.9 dCI 2004>2010

ALTERNATOR / ALTERNATOR:
VALEO: SG15L035, 439474, 2543596;

RENAULT: 7711134926, 8200138269, 8200225806, 8200290220, 8200495268, 8200495269, 8200667616, 8200667617

VALEO
GA950

FEATURES / CARACTERÍSTICAS: 14V, 'A' Circuit, Terminals L e FR

REPLACES / REEMPLAZA:
Hyundai: 373702B250; **AS Poland:** ARE3114

APPLICATION / APLICACIÓN:
HYUNDAI: HB20 1.6 16V >2012, I30 1.6 >2009, Veloster 2012>; **KIA:** Soul 1.6 2009, Cerato 1.6 16V >2009

ALTERNATOR / ALTERNATOR:
VALEO: 2655447; **HYUNDAI:** 37300-2B101

RECTIFIER:

GA1812

VALEO
GA952 // NEW //

FEATURES / CARACTERÍSTICAS: 14V, 'A' Circuit

REPLACES / REEMPLAZA:
Mobiletron: VR-PR123; **Regitar:** VRPR123; **Cargo:** 130655; **Transpo:** IP123; **Era:** 215729

APPLICATION / APLICACIÓN:
CITROËN: Visa 650 1978>1983

ALTERNATOR / ALTERNATOR:
CITROËN/ PEUGEOT: 5705 1A (C), 5705 Y5 (C)

VALEO
GA953

FEATURES / CARACTERÍSTICAS: 14V, 'B' Circuit

REPLACES / REEMPLAZA:
Mobiletron: VR-PR6603H; **As-Poland:** ARE3019; **Cargo:** 235082; **Transpo:** M519

APPLICATION / APLICACIÓN:
ALFA ROMEO: GT 937 1.9 2004>2010

CITROËN: Berlingo 2.0 2002>2005, C5 2.2 2001>2002, Evasion 2.0 1999>2002, Jumper 2.0/2.2 2001>2004, Jumpy 2.0 2000>2003, Xsara 2.0 1999>2002

FIAT: Ducato Box 2.0 2002>2004, Scudo Box 2.0 1999>2002, Ulysse 2.0 1999>2002

ALTERNATOR:
CITROËN: 5705GC, 9624177680, 9639362380, 9641302580, 9645907680, 9645907780

FIAT: 9636254180, 9640878780

VALEO
GA954 // NEW //

FEATURES / CARACTERÍSTICAS: 14V, S. POINT: 14,5V, 'B' Circuit

REPLACES / REEMPLAZA:
Valeo: 593454, 593874, YM1666FP5; **Elccor:** ARG-PR1510E; **Mobiletron:** VR-V3874; **Regitar:** V3874; **AS-Poland:** ARE3026; **Cargo:** 234961; **Transpo:** M557

APPLICATION / APLICACIÓN:
Mercedes-Benz - Europe Car: A140 1400 1997>2004, A160 1600 1997>2004, A190 1900 1999>2004, Vaneo 1600 2002>2005

ALTERNATOR:
MERCEDES-BENZ: 010-154-38-02, 010-154-39-02, 011-154-56-02, 011-154-82-02, 012-154-43-02, 012-154-44-02, 012-154-45-02, A010-154-39-02, A0101543802, A011-154-82-02, A0111545602, A012-154-43-02, A012-154-44-02, A012-154-45-02;

VALEO: SG9B037, SG9B038, SG9B039

VALEO
GA962 // NEW //

FEATURES / CARACTERÍSTICAS: 14V, 'B' Circuit

REPLACES / REEMPLAZA:
Valeo: 593423; **Transpo:** M523; **Mobiletron:** VR-PR2206; **Regitar:** VR-PR2206; **AS-Poland:** ARE3038; **Cargo:** 237938; **Era:** 216010

APPLICATION / APLICACIÓN:
BMW: Z3 L6 2.5/3.0 2001>2002, Z3 Coupe 2.8i 1997>2000, X5 L6 3.0 2001>2006, Series 3: 320i/323i/328i 1998>2000, Series 5: 520i 1996>2000, 523i 1996>2000

ALTERNATOR:
BMW: 12-31-7-501-592, 12-31-7-501-687, 12-31-7-510-593, 12-31-7-510-597, 12-31-7-510-599, 12-31-7-530-086, 12-31-7-532-627, 12-31-7-551-252, 12-31-7-551-253, 12-31-7-830-791, 12-31-7-831-436, 12-41-1-432-977, 12-41-1-740-624, 12-41-1-740-626;

VALEO: SG9B029

VALEO
GA965

FEATURES / CARACTERÍSTICAS: 14V, 'B' Circuit

REPLACES / REEMPLAZA:
Valeo: 593689; **Transpo:** M549; **Cargo:** 234818; **As-Poland:** ARE3029; **Mobiletron:** VR-V3689; **Regitar:** V3689

APPLICATION / APLICACIÓN:
OPEL: Movano Box 2.2 2000>2003, Vivaro Box/Combi 2.0 16v 2001; **MITSUBISHI:** Carisma 1900 1.9 2000>2004, Space Star 1900 1.9 2000>2015; **NISSAN:** Kubistar Box 1.5 2003>2010, Micra 1500 2002>2010; **RENAULT:** Megane 1500 2005>2010, Megane Grand Scenic 1500 2005>2010; **VOLVO:** S40 I 1900 1.9 2000>2003, V40 1900 1.9 2000>2003, V40 Estate 1.9 2000>2004

ALTERNATOR:
DACIA: 23100-5770R, 7711368356, 8200810614

MITSUBISHI: S30638577, S30750737, S30774528, S883627

NISSAN: 23100-00Q2H, 23100-00QAP, 23100-00QBH, 23100-00QBK, 23100-3831R, 23100-7788R, 23100-BN700, 23100-BN701

OPEL: 4403540, 4431340, 9111540

RENAULT: 2310 000 91R, 2310 075 62R, 23100-5225R, 23100-5770R, 23100-7035R, 231007707R

VOLVO: 30883627, 8251641, 8602806

VALEO

GA966 // NEW //



FEATURES / CARACTERÍSTICAS: 14V, 'A' Circuit

REPLACES / REEMPLAZA:

Cargo: 131477; **Transpo:** IP1903; **Mobiletron:** VR-PR128; **Regitar:** VRPR128; **Era:** 215737

APPLICATION / APLICACIÓN:

HYUNDAI: Excel L4 1.5 1986>1987, Pony L4 1.4/1.5 1983>1987, Stellar L4 1.6 1985>1986;

DEUTZ ENGINES: Industrial All Models Stationary Engines 0000;

VERMEER MISC. EQUIPMENT: 672 Stump Grinder 0000;

CASE ROLLER: 252 Hatz Diesel 1975

ALTERNATOR:

BOMAG: 5716778, 5716778; **DEUTZ ENGINES:** 01177327K2, 01179755K2; **HATZ:** 40121000, 40121002, 50374700, 50374700, 50374701, 50374702, 50504200; **HYUNDAI:** 37300-11501, 37300-11530; **KHD:** 0117-9757, 117-7328, 117-9755, 117-9757

VALEO

GA967 // NEW //



FEATURES / CARACTERÍSTICAS: 14V, 'A' Circuit

REPLACES / REEMPLAZA:

Valeo: TA500C0041; **Cargo:** 234286; **AS-Poland:** ARE5085; **Transpo:** IY796

APPLICATION / APLICACIÓN:

HYUNDAI: Amica 1100 2000>2010, Atos 1000 1998>2005

ALTERNATOR:

VALEO: 439384;

HYUNDAI: 37300-02503

VALEO

GA968 // NEW //



FEATURES / CARACTERÍSTICAS: 14V, 'B' Circuit

REPLACES / REEMPLAZA:

Cargo: 236601; **AS-Poland:** ARE3031; **Transpo:** M578; **Era:** 216227

APPLICATION / APLICACIÓN:

BMW: Europe Car 3 318 d 2002>2003, 3 320 d 2002>2005, 3 330 d 2003>2005, 3 Compact 318 2003>2005, 3 Convertible 320 2005>2007, 3 Coupe 320 Cd 2003>2006, 3 Touring 318 d 2002>2003, X3 2000 2004>2007, X5 2003>2006;

LAND ROVER: Freelander 2.0L 2002>2006

ALTERNATOR:

BMW: 12317789980, 12317789983, 12317797660, 12317797661;

LAND ROVER: YLE500170, YLE500170E

VALEO

GA970 // NEW //



FEATURES / CARACTERÍSTICAS: 14V, 'B' Circuit

REPLACES / REEMPLAZA:

Valeo: 2543204, 2543231, 593877, 593983, 593984, 599102; **Cargo:** 235853; **AS-Poland:** ARE3055; **Transpo:** M543

APPLICATION / APLICACIÓN:

BMW: 323i L6 2.5L 2006, 325i L6 3.0L 2006, 330i L6 3.0L 2006, 525i L6 3.0L 2006>2007, 525xi L6 3.0L 2006>2007, 530i L6 3.0L 2006>2007, 530xi L6 3.0L 2006>2007, 325i 2.5L Non-Turbo 2005>2008, 523i 2.5L Non-Turbo 2006>2007, 525i 2.5L Non-Turbo 2006>2007, 530Li 3.0L Non-Turbo 2006>2007, 630i 2004>2007

ALTERNATOR:

BMW: 12-31-7-521-178, 12-31-7-524-972, 12-31-7-525-376, 12-31-7-525-440, 12-31-7-537-959, 12-31-7-537-962, 12-31-7-540-990, 12-31-7-540-992, 12-31-7-540-993, 12-31-7-540-994, 12-31-7-542-934, 12-31-7-542-935, 12-31-7-550-993, 12-31-7-561-003, 12-31-7-561-004, 12-31-7-792-878, 12-31-7-796-125, 12-31-7-797-523, 12-31-7-797-524, 12-31-7-801-173

VALEO: 2542720, 2542720F, 2543314A, TG17C015, TG17C016, TG17C016B, TG17C021, TG17C021B, TG17C027, TG17C027B, TG17C034, TG17C035, TG17C036

VALEO

GA973 // NEW //



FEATURES / CARACTERÍSTICAS: 14V, 'B' Circuit

REPLACES / REEMPLAZA:

Cargo: 236390; **AS-Poland:** ARE3113; **Transpo:** M525; **Mobiletron:** VR-PR3389; **Regitar:** VRPR3389

APPLICATION / APLICACIÓN:

NISSAN: Micra 1000/1200/1400 2002>2010, Micra C+ 1.4 16V 2005, Micra III 1.0/1.2/1.4 2003>2010

HYUNDAI: Santa Fé 2700 16V 2001>2002, Sonata 2500 1998>2001, Sonata 2700 2001>2002, Trajet 2700 V6 2001>2002

KIA: Magentis 2500 V6 2001>2004

ALTERNATOR:

HYUNDAI / KIA: 37300-37200, 37300-37250;

NISSAN: 23100-AX600

VALEO

GA974 // NEW //



FEATURES / CARACTERÍSTICAS: 14V, 'A' Circuit

REPLACES / REEMPLAZA:

Valeo: 593333; **Cargo:** 139475; **AS-Poland:** ARE3024; **Transpo:** M537; **Mobiletron:** VR-PR1671; **Regitar:** VRPR1671

APPLICATION / APLICACIÓN:

BMW: 318 1700 M41 D18 1995>2001, 5 (E39) Eng.M51 D25 (Inter.) 525 tds M51 D25 1996>1998, 5 Touring (E39) Eng.M51 D25 (256T1) 525 tds 105kw M51 D25 1997>1998

ALTERNATOR:

VALEO: A13V1150, 439093;

BMW: 12311740633, 12312245576, 12312245654, 12312246070

VALEO
GA975 // NEW //

FEATURES / CARACTERÍSTICAS: 14V, 'B' Circuit

REPLACES / REEMPLAZA:

Cargo: 235205; **AS-Poland:** ARE9024

APPLICATION / APLICACIÓN:

CHEVROLET: Matiz 0.8 1998>2005, Matiz 1.0 2003>2005, Spark 0.8 2005>2015

ALTERNATOR:

VALEO: TA000A30601;

CHEVROLET: 96314258

VALEO
GA977 // NEW //

FEATURES / CARACTERÍSTICAS: 14V, 'B' Circuit

REPLACES / REEMPLAZA:

Valeo: 593948, 593975, 595385; **Transpo:** M568; **Cargo:** 238340

APPLICATION / APLICACIÓN:

Mercedes Benz: A150 1.5 2004>2009, A170 1.7 2004>2009, A200 2.0 2004>2010, A200 2.0 Turbo 2005>2010, B150 1.5 2005>2010, B170 1.7 2005>2010, B200 2.0 2005>2010, B200 2.0 Turbo 2005>2010

ALTERNATOR:

VALEO: 2542774, 440410, TG11C021, TG11C035, TG11C074;

MERCEDES-BENZ: 266-154-06-02, 266-154-09-02, A266-154-06-02, A266-154-09-02, A2661541302

VALEO
GA980

FEATURES / CARACTERÍSTICAS: 14V, 'B' Circuit

REPLACES / REEMPLAZA:

Valeo: 593480, 595229; **Regitar:** VRPR2292; **Cargo:** 231103; **WAI/Transpo:** M547; **Magneti Marelli:** RT510254

APPLICATION / APLICACIÓN:

VW: Gol 1.0/ 1.6 with AC 03>, Polo 1.0/ 1.6 with AC 03>, Fox 1.0/ 1.6 with AC 03>, Golf 1.6 with AC 99>.

ALTERNATOR / ALTERNATOR:

VALEO: 439739, 439445, SG8B017, SG9B024, TG11S142; **VW:** 04C 903 024A

RECTIFIER:

GA1832 / GA1884

VALEO
GA981

FEATURES / CARACTERÍSTICAS: 14V, "A" Circuit, D+, DF and D- (3 terminals with IG and L)

REPLACES / REEMPLAZA:

Valeo: TA500B11101; **GM:** 93740810; **Cargo:** 238143; **WAI/Transpo:** M582

APPLICATION / APLICACIÓN:

GM: Corsa, Aveo

ALTERNATOR / ALTERNATOR:

...

VALEO
GA984

FEATURES / CARACTERÍSTICAS: 14V, 'B' Circuit

REPLACES / REEMPLAZA:

Valeo: 593384, 593396, 593458, 593546, 2542299; **Regitar:** VRPR2299; **Mobiletron:** VR-PR2299H; **Cargo:** 232962; **WAI/Transpo:** M546, M570; **AS Poland:** ARE3028; **Magneti Marelli:** RT510257

APPLICATION / APLICACIÓN:

RENAULT: Clio 1.0 99>, Clio 1.0 16V 01>, Clio 1.6 without AC without DH 07/02>, Mégane 1.6 16V without AC, Scenic 1.6 without AC 02>, Kangoo 1.0 02>, Kangoo 1.6 without AC without DH 07/02>, Kangoo 1.6 with AC 12/00>, Mégane 1.6 16V with AC 00>, Mégane 2.0 with A/C 12/02>, Scenic 1.6 with AC 00>, Scénic 2.0 with AC 12/02>, Clio 1.6 with AC 12/00>;

PEUGEOT: 206 1.0 s/AC 10/02>.

ALTERNATOR / ALTERNATOR:

VALEO: 439429, SG7S012, SG7S013, SG7S070, SG9B047, SG9B033, SG10B019, 2543550B

RECTIFIER:

GA1807

VALEO
GA985

FEATURES / CARACTERÍSTICAS: 14V, 'B' Circuit, Terminal COM

REPLACES / REEMPLAZA:

Regitar: V8237, V4114; **Cargo:** 330202; **WAI/Transpo:** M571

APPLICATION / APLICACIÓN:

RENAULT: Grand Scénic II 1.6 2006>2012, Kangoo II 1.6 16V Hi-Flex 2008>2012, Mégane II 1.6 2006>2009, Modus 1.4/1.6 2004>2012, Scénic II 1.4 2006>2009, Scénic II 1.6 16V 2006>2012

ALTERNATOR / ALTERNATOR:

Valeo: TG11C060, TG11C039, TG11C055; **Renault:** 8200410669, 8200588648, 8200667619

RECTIFIER:

GA1885

VALEO
GA988

FEATURES / CARACTERÍSTICAS: 14V, 'B' Circuit

REPLACES / REEMPLAZA:

Valeo: 2620798

APPLICATION / APLICACIÓN:

RENAULT: Oroch 2.0 16V 2016, Renault Duster 2.0L 2011>

ALTERNATOR / ALTERNATOR:

VALEO: TG12C213; **RENAULT:** 2622557

RECTIFIER:

GA1827

VALEO
GA994

FEATURES / CARACTERÍSTICAS: 14V, B Circuit, RVC SYSTEM. SETPOINT 14,4V

REPLACES / REEMPLAZA:

Valeo: 2650441, 2650561 15926088, 2650557, 01638104, 2606074, 18145313, 2479939, 0602140953;

Ikro: IK5054

APPLICATION / APLICACIÓN:

GM: Captiva 2009, Cobalt 2008>2010, Malibu 2008>2011

ALTERNATOR / ALTERNATOR:

GM: 15828450, 2650532 B, 20915894;

Valeo: 25946766, FG12S028, 2605168A, 2605168

RECTIFIER:

GA1888

VALEO
GA996

FEATURES / CARACTERÍSTICAS: 14V, 'B' Circuit

REPLACES / REEMPLAZA:

Valeo: 2541996B, 2541915, 593319, YM1919P1; **Cargo:** 139482; **Mobiletron:** VR-PR003H

APPLICATION / APLICACIÓN:

MERCEDES BENZ: A Class 160, 190

ALTERNATOR / ALTERNATOR:

...

VALEO
GA997

FEATURES / CARACTERÍSTICAS: 14,5V, 'B' Circuit

REPLACES / REEMPLAZA:

Valeo: 593419, 2542549B; **Regitar:** V3419, V3779; **Cargo:** 233633, M564, 235229; **Elcoor:** ARG-PR0510E; **Mobiletron:** VR-V3779; **AS-Poland:** ARE3047; **Transpo:** M579

APPLICATION / APLICACIÓN:

CITROËN: Berlingo 1.1 /1.4 /1.9 (Diesel /Gasoline) 1996>, Xsara 1.4 /1.6 1996>, C15 Diesel 2000-2005; **FIAT:** Scudo Diesel 1998>;

PEUGEOT: 206 1.1 /1.4 /1.6 /2.0 1998>;

MERCEDES-BENZ: A160 1.7 2001>2015, A170 1.7 CDI 2001>2004, Vaneo 1.7 CDI 2002>2005

ALTERNATOR / ALTERNATOR:

VALEO: A11V1106, A11V1108, A13V1276, A13V1277, A13V1278, A13V1279, A13V1283, A13V1288; **MERCEDES-BENZ:** 668-154-01-02, 668-154-02-02, 668-154-03-02, A668-154-01-02, A668-154-02-02, A668-154-03-02; **CITROËN/ PEUGEOT:** 5705 5T, 5705 5X, 5705 6S, 5705 6T, 5705 6Y, 5705 6Z, 5705 6J, 5705 6N, 9638276180

VALEO
GA998

FEATURES / CARACTERÍSTICAS: 14V, 'B' Circuit

REPLACES / REEMPLAZA:

Valeo: 2605460, 599386; **Transpo:** M608; **Cargo:** 333903

APPLICATION / APLICACIÓN:

GM: Agile, Captiva, Montana 2010

ALTERNATOR:

VALEO: SG93B111, 2606873, 25946766; **GM:** 13500316, 13502988, 22962097

VALEO - MOTOROLA
GA500

FEATURES / CARACTERÍSTICAS: 14V, 'A' Circuit, Terminals L, W e IG

REPLACES / REEMPLAZA:

Valeo: 2541496, 2541406, 592793, 9RC2055, 9RC2062; **Renault:** 7701203872; **Cargo:** 135434; **WAI/Transpo:** M513HD

APPLICATION / APLICACIÓN:

RENAULT: R19 1.8 89-95, Safrane 2.0 92-96

ALTERNATOR / ALTERNATOR:

VALEO: A11VI26, A11VI28, A11VI30, A11VI31, A11VI59, A11VI61, A13V111, A13V114, A13V116, A13V117, A13V120, A13V121, A13V123, A13V125, A13V132, A13V134, A13V135, A13V145, A13V147, A13V165, A13V166, A13VI104, A13VI105, A13VI106, A13VI107, A13VI11, A13VI131, A13VI14, A13VI16, A13VI17, A13VI20, A13VI21, A13VI22, A13VI23, A13VI25, A13VI32, A13VI34, A13VI35, A13VI45, A13VI47, A13VI55, A13VI62, A13VI63

VALEO - MOTOROLA
GA501

FEATURES / CARACTERÍSTICAS: 14V, 'A' Circuit

REPLACES / REEMPLAZA:

Valeo: 2521335, 2541392, 2541404, 2541433, 2541493, 2541666, 2541667, 2541682, 2541701, 2541702, 2541721, 2541800, 2541972, 2590768, 592791, 592797, 592800, 592801, 592910, 592911, 593131, 593133, 593137, 593139, 593258, 593301, 593312, 593326, 593350, 9RC6065, YM1940G, YM1949, YM1950, YM3953, YM6555, YM6952, YM6955, YM9980, YV1965, YV1965T, YV1969T, YV3970H; **Regitar:** VRVW010; **Mobileron:** VR-VW010; **Cargo:** 134475, 133988; **WAI/Transpo:** M511; **AS Poland:** ARE3002

APPLICATION / APLICACIÓN:

AUDI: 100, 80, A4, A6, Cabriolet, Coupe;

CITROËN: ZX 1.1/ 1.4, Saxo 1.0/ 1.1/ 1.4, Xsara 1.4, Berlingo 1.1;

PEUGEOT: 106 1.1/ 1.3/ 1.4/ 1.6/ Xsi, Rallye, 306 1.1/ 1.4/ 1.6, 405 1.4/ 1.9, Partner 1.1/ 1.4;

SEAT: Arosa, Ibiza, Cordoba, Inca, Toledo;

SKODA: Felicia;

VW: Caddy, Corrado, Golf 1.4/ 1.6/ 1.8/ 1.9d/ 2.0, Passat, Polo, Vento 1.4/ 1.6/ 1.8

ALTERNATOR / ALTERNATOR:

2542101, A11VI8, A11VI23, A11VI26, A11VI36, A11VI45, A11VI49, A11VI57, A11VI61, A11VI64, A11VI85, A11VI93, A13VI100, A13VI104, A13VI105, A13VI106, A13VI121, A13VI123, A13VI124, A13VI125, A13VI132, A13VI135, A13VI141, A13VI155, A13VI156, A13VI164, A13VI184, A13VI185, A13VI186, A13VI189, A13VI191, A13VI198, A13VI209, A13VI212, A13VI213, A13VI216, A13VI218, A13VI22, A13VI220, A13VI222, A13VI231, A13VI24, A13VI258, A13VI260, A13VI261, A13VI264, A13VI265, A13VI266, A13VI267, A13VI268, A13VI274, A13VI280, A13VI281, A13VI31, A13VI40, A13VI41, A13VI44, A13VI45, A13VI52, A13VI57, A13VI60, A13VI67, A13VI69, A13VI70, A13VI71, A13VI74, A13VI75, A13VI81, A13VI85, A13VI94, A13VI96, A13VI99, A14VI14, A14VI31; **VOLKSWAGEN:** 021-903-023N, 021-903-025F, 030-903-023E, 030-903-023F, 037-903-023G, 037-903-023Q, 058-903-016E, 078-903-015B, 078-903-015D, 078-903-017B

VALEO - MOTOROLA
GA502

FEATURES / CARACTERÍSTICAS: 14V, 'A' Circuit

REPLACES / REEMPLAZA:

Valeo: 2541715, 2541715C, 590932; **Valeo-Motorola:** 9RC6074; **Magneti Marelli:** 940 038 191; **Fiat:** 9946195; **Regitar:** VRPR1669; **Cargo:** 136546; **WAI/Transpo:** M514; **AS Poland:** ARE3006

APPLICATION / APLICACIÓN:

FIAT: Ducato Bus, Pritsche, Kasten

ALTERNATOR / ALTERNATOR:

VALEO: A13VI72, A13VI73

VALEO - MOTOROLA
GA503

FEATURES / CARACTERÍSTICAS: 14V, 'B' Circuit

REPLACES / REEMPLAZA:

Valeo-Motorola: 2541668, 593290, 593310, 593349; **Regitar:** VRPR002; **Cargo:** 139456; **WAI/Transpo:** M517; **AS Poland:** ARE3007; **Magneti Marelli:** RT510161

APPLICATION / APLICACIÓN:

RENAULT: from 1996 Safrane, Espace, Laguna, Megane, Scenic;

LINDE: Forklifts with engine Renault

ALTERNATOR / ALTERNATOR:

VALEO: A11VI105, A11VI179, A11VI79, A11VI81, A11VI85, A11VI92, A11VI93, A13VI157, A13VI163, A13VI164, A13VI165, A13VI166, A13VI167, A13VI179, A13VI184, A13VI185, A13VI201, A13VI207, A13VI208, A13VI209, A13VI210, A13VI211, A13VI213, A13VI217, A13VI218, A13VI224, A13VI266, A13VI267, A14VI17, A14VI18, A14VI24, A14VI25, A14VI85, A14VI92

VALEO - MOTOROLA
GA504

FEATURES / CARACTERÍSTICAS: 14V, 'B' Circuit

REPLACES / REEMPLAZA:

Valeo-Motorola: 2541952, 593 316, 593411, YM 1620; **Renault:** 7701 049 500; **Regitar:** VRPR1620; **Cargo:** 235819; **WAI/Transpo:** M516; **AS Poland:** ARE3016; **Magneti Marelli:** RT510162

APPLICATION / APLICACIÓN:

RENAULT: Clio II 03/98, Kangoo 1.4/ 1.9 -97 Espace III 2.0 98 Mégane & Laguna

ALTERNATOR / ALTERNATOR:

VALEO: A11VI87, A11VI88, A13VI188, A13VI195, A13VI235, A13VI238, A13VI249, A13VI251, A13VI252, A13VI253

RECTIFIER:

GA1807

VALEO - MOTOROLA
GA515

FEATURES / CARACTERÍSTICAS: 14V, 'A' Circuit

REPLACES / REEMPLAZA:

Valeo: 92856, 92913, 92973, 97729, NC168, NC170, NC173, YL120, YL121, YL127; **Magneti Marelli:** 940 038 164; **Peugeot:** 5761.40; **Lucas:** 2 1225 178, UCB 224; **Regitar:** VRPR120; **WAI/Transpo:** IP127

APPLICATION / APLICACIÓN:

PEUGEOT: 504, 505, 604

ALTERNATOR / ALTERNATOR:

VALEO: A13R214, A14N39, A14R33, A14R35; **PEUGEOT:** 570272, 570283, 570286

VALEO - MOTOROLA
GA520

FEATURES / CARACTERÍSTICAS: 14V, 'A' Circuit

REPLACES / REEMPLAZA:

Audi/VW: 036-903-803A, 049-903-803H; **Ducellier:** 592989; **Lucas:** 21229199, UCB506; **Magneti Marelli:** 940038151; **Motorola:** 2940030, 2940318, 505-100, 505-105, 9RC2018, 9RC7088, 9RC7104; **Valeo:** 2519124, 2519490, 2522098, 2522939, 2523198, 2541484, 2940022, 592781, 592806, 592888, 592952, 592963, A519124A, A521760A, A940318A, NB492, YV1923, YV4904, YV99, YV9911; **Regitar:** VRVW005NH; **Cargo:** 131224; **WAI/Transpo:** M506; **AS Poland:** ARE3001

APPLICATION / APLICACIÓN:

VW: DERBY MK1, MK2, GOLF MK1, MK2, JETTA MK1, MK2, PASSAT MK1, MK2, SCIROCCO MK1, MK2, POLO MK2, SANTANA (32B); **SEAT:** TOLEDO MK1; **AUDI:** 80 MK2 SALOON (81, 85, B2), COUPE (81, 85), QUATTRO (85);

ALTERNATOR / ALTERNATOR:

Motorola / Valeo: 9AR2977L, 9AR5088L; **Valeo:** 2940305, 2940375, A13E07, AE13E13, A14V13

VALEO - PARIS RHONE
GA639

FEATURES / CARACTERÍSTICAS: 14V, 'A' Circuit

REPLACES / REEMPLAZA:

Valeo: 300725, 300883, 590660, 2590558, **Paris Rhone:** YH1639, YH2602, YH2605, YH2606, YL126, YL138, YL139, YI151; **Regitar:** VRPR126; **Cargo:** 131146; **WAI/Transpo:** IP1639; **AS Poland:** ARE3011

APPLICATION / APLICACIÓN:

RENAULT;

SAAB;

WINNEBAGO

ALTERNATOR / ALTERNATOR:

VALEO: 432716, 432717; **PARIS RHONE:** A13N10, A13N103, A13N104, A13N105, A13N106, A13N107, A13N110, A13N112, A13N113, A13N114, A13N115, A13N116, A13N117, A14N76

RECTIFIER:

GA1452

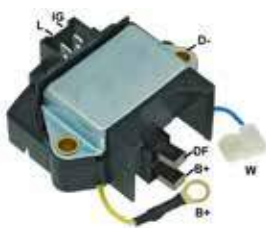
VALEO - PARIS RHONE
GA652

FEATURES / CARACTERÍSTICAS: 14V, 'A' Circuit

REPLACES / REEMPLAZA:

Valeo: 182046, 300806, 300868, 300901; **Paris Rhone:** YL1649, YH1652, YH1654, YL122, YL129, YL149, YL152, YI154, YL155; **Lucas:** UCB223; **Regitar:** VRPR1652; **Cargo:** 130657; **WAI/Transpo:** IP1652; **AS Poland:** ARE3011

APPLICATION / APLICACIÓN:

RENAULT: R21, R19 RT, Clio;

VOLVO;

AMC

ALTERNATOR / ALTERNATOR:

PARIS RHONE: A13N12, A13N13, A13N14, A13N15, A13N17, A13N6, A13R218, A13R221, A13R222, A13R228, A13R230, A13R231

VALEO - PARIS RHONE
GA925

FEATURES / CARACTERÍSTICAS: 14V, 'A' Circuit

REPLACES / REEMPLAZA:

Valeo: 92897, 92902, 92940, 92981; **Paris Rhone:** YL132, YI190, YH1925, YV1924; **Lucas:** 21225183, UCB220; **Regitar:** VRPR1925, VRPR2000H; **Cargo:** 130661; **WAI/Transpo:** IP125; **Mobiletron:** VR-PR2000H

APPLICATION / APLICACIÓN:

CITROËN; PEUGEOT;

RENAULT;

VOLVO;

MASERATI;

MERCEDES BENZ: 1920

ALTERNATOR / ALTERNATOR:

PARIS RHONE: A12R33, A12R52, A13N32, A13N39, A13N41, A13R267, A13R268, A14N16, A14N23, A14N78, A14N80.

VALEO - PARIS RHONE
GA955

FEATURES / CARACTERÍSTICAS: 28V, 'A' Circuit

REPLACES / REEMPLAZA:

Valeo: 92955, NC 692, ZL 127; **Regitar:** VRPR127B; **Cargo:** 133322; **WAI/Transpo:** IP955

APPLICATION / APLICACIÓN:

Industrial

ALTERNATOR / ALTERNATOR:

VALEO: 2099801, 2099821, 2103484, 2100225, 2103164, 2103163, A12R351T, A12R335T, A14R134, A14R154, A14R1543, A14R1134T, A14R1541T, A14R1543T, A14R1341T, A14R1542T, A14R1545T, A14R135T, A14R134T, A14R154T

VALEO - PARIS RHONE
GA956

FEATURES / CARACTERÍSTICAS: 14V, 'A' Circuit

REPLACES / REEMPLAZA:

...

APPLICATION / APLICACIÓN:

RENAULT

ALTERNATOR / ALTERNATOR:

VALEO: 2097455, 2097772, 2098215, 2098229, 2099419, 2099421, 2099422, 2099761, 2099767, 2100309, 2100349, 2100597, 2100678, 2100954, 2100, 2101935, 2101988, 2102158, 2102231, 2105113, 2105555, 432857, 71651802, 71652602, 71770202, A12R36, A12R43, A12R45, A12R57, A13M14, A13R147, A13R222, A13R228, A13R230, A13R231, A13R242, A13R243, A41R45

VALEO - PARIS RHONE
GA926

FEATURES / CARACTERÍSTICAS: 14V, 'A' Circuit

REPLACES / REEMPLAZA:

Valeo: 2590512, 300741, 300692, 92966, NC927, NC362, VI; **Paris Rhone:** YL135, YL146, IL 147; **Lucas:** UCB243; **Cargo:** 131226;

WAI/Transpo: IP735B

APPLICATION / APLICACIÓN:

RENAULT: Marine;

VOLVO: Penta

ALTERNATOR / ALTERNATOR:

VALEO: A13N28M, A14N48M, A14N66M, A13N29M, A13N35M, A13N55M, A13N57M, A13N58M, A13N66M, A14N29M, A13N148M, A13N186M, A13N259M, A13N35M, A13N36M

VALEO - PARIS RHONE
GA927

FEATURES / CARACTERÍSTICAS: 28V, 'A' Circuit

REPLACES / REEMPLAZA:

Valeo: 300744, NC184; **Paris Rhone:** ZL129; **Lucas:** 21225372, UCB 239; **Magneti Marelli:** 940 038 174; **Regitar:** VRPR135BA; **Cargo:** 131300; **WAI/Transpo:** IP129B; **Mobiletron:** VR-PR2000H

APPLICATION / APLICACIÓN:

VOLVO: Penta, Industrial Applications

ALTERNATOR / ALTERNATOR:

VALEO: A13N143M, A13N152M, A13N36M, A13N56M, A13N59M, A14N110M, A14N112M, A14N115M, A14N116M, A14N118M, A14N206M, A14N47M.

VALEO - PARIS RHONE
GA969

FEATURES / CARACTERÍSTICAS: 28V, 'A' Circuit

REPLACES / REEMPLAZA:

Valeo: 182169, ZV3902H, ZH3902, 182769; **Regitar:** VRPR135BA; **Cargo:** 131300; **WAI/Transpo:** IP129B

APPLICATION / APLICACIÓN:

VOLVO: Volvo FH12 05/98 >, Volvo NH12 05/98 >, Serie Globetrotter 05/98 >

ALTERNATOR / ALTERNATOR:

VALEO: 439231, A14N183M, A14N208M

RECTIFIER:

GA1882

VALEO - PARIS RHONE
GA928

FEATURES / CARACTERÍSTICAS: 28V, 'A' Circuit

REPLACES / REEMPLAZA:

Valeo: 590536; **Paris Rhone:** ZV 3729, ZY 3729; **Volvo:** 872368; **Magneti Marelli:** 940 038 173; **Regitar:** VRPR3729A; **Cargo:** 235829; **WAI/Transpo:** IP729B

APPLICATION / APLICACIÓN:

VOLVO: Trucks F10, F12, FL10, FL6, FL7, N10, N12

ALTERNATOR / ALTERNATOR:

VALEO: 2102052, 2180619, 2180620, 2181991, 2541168, 2541199, A13N33M, A14N100M, A14N119M, A14N122M, A14N137, A14N137M, A14N141M, A14N200, A14N200M, A14N30M, A14N81M; **PIC:** 208399, 208400

VALEO - PARIS RHONE
GA929

FEATURES / CARACTERÍSTICAS: 14V, 'A' Circuit

REPLACES / REEMPLAZA:

Valeo: 2518337, 2541291, 2590512, 300692, 300741, 300747, 92966, YV7735, YV7735H; **Cargo:** 131226; **WAI/Transpo:** IP735B

APPLICATION / APLICACIÓN:

VOLVO: Marine

ALTERNATOR / ALTERNATOR:

VALEO: 2100605, 2100606, 2102051, 2102341, 2102794, 2103141, 2103142, 2105582, 2518088, A13N147M, A13N148M, A13N149M, A13N1M, A13N35M, A13N55M, A13N66M, A14N148, A14N29M

VISTEON
GA350

FEATURES / CARACTERÍSTICAS: 14V, 'A' Circuit

REPLACES / REEMPLAZA:

Regitar: VRVN002; **WAI/Transpo:** F610

APPLICATION / APLICACIÓN:

FORD: Ford Fiesta, Ka, EcoSport, Courier

ALTERNATOR / ALTERNATOR:

FORD: 3N2110300BB, 3N2110300AA

RECTIFIER:

GA1890 / GA1891

VISTEON
GA355

FEATURES / CARACTERÍSTICAS: 14V, 'A' Circuit, Terminals S-FR- IL

REPLACES / REEMPLAZA:

Regitar: GR911; **Cargo:** 239306; **WAI/Transpo:** F613

APPLICATION / APLICACIÓN:

FORD: Transit 2.4 90CV 2000>2006

ALTERNATOR / ALTERNATOR:

VISTEON: YC1UEA; **FORD:** YC1U10300EA, YC1U10300DB, YC1U10300DA, YC1T10300BJ, YC1T10300BH, YC1T10300BG, YC1T10300BE, YC1T10300BD, YC1T10300BC, YC1O10300DB, YC1O10300DA

VISTEON
GA360

FEATURES / CARACTERÍSTICAS: 14V, 'A' Circuit

REPLACES / REEMPLAZA:

Regitar: VRVN001; **Cargo:** 235601; **WAI/Transpo:** F611; **AS Poland:** ARE9026

APPLICATION / APLICACIÓN:

FORD: Focus, EcoSport, Fusion

ALTERNATOR / ALTERNATOR:

VISTEON: 20 150 01005, 1S7T-10300-BA, 1S7Z-10346-BC. Whip with three wires

RECTIFIER:

GA1890



ELECTRICAL SPARE PART | PIEZA ELÉCTRICA

RECTIFIER | RECTIFICADOR

AGRALE
GA1672 // NEW //

FEATURES / CARACTERÍSTICAS: 110A, 6x50A Avalanche Diode, B+: M8X14.5mm
REPLACES / REEMPLAZA:
 ...
APPLICATION / APLICACIÓN:
JAC: J6 2.0 16V 2010>
ALTERNATOR / ALTERNATOR:
VALEO: TG11S072; **JAC:** 1015301GA

BOSCH
GA1001

FEATURES / CARACTERÍSTICAS: 55A, Diodes 3x35A, without diode trio
REPLACES / REEMPLAZA:
Bosch: 1 125 715 064, 9 121 080 349, 1 125 715 065, 9 121 080 671, 9 121 080 244, 9 121 080 849
APPLICATION / APLICACIÓN:
MISCELLANEOUS: Tractors Agrale, CBT, Fiat-Allis, Komatsu, Massey Perkins (to 85). Equipment Yanmar, Mercedes Benz;
SCANIA: Trucks, Bus, Marine Engine / Stationary;
TOYOTA: Bandeirantes and Utilitários (to 87);
VOLVO: Trucks N10, N12 e Bus B58 (to 85);
FIAT DIESEL: all models (to 82).
ALTERNATOR / ALTERNATOR:
BOSCH: 9 120 080 020, 9 120 080 031, 9 120 080 054, 9 120 080 084, 9 120 080 091, 9 120 080 082, 9 120 080 110, 9 120 080 125
VOLTAGE REGULATOR:
 GA004 / GA005

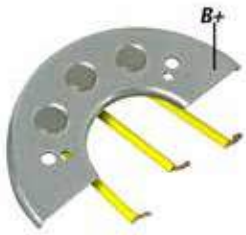
BOSCH
GA1003

FEATURES / CARACTERÍSTICAS: 55A, Diodes 3x35A, with diode trio
REPLACES / REEMPLAZA:
Bosch: 1 125 715 064, 9 121 080 349, 1 125 715 065, 9 121 080 671, 9 121 080 244, 9 121 080 849; **Magneti Marelli:** PR520402
APPLICATION / APLICACIÓN:
MISCELLANEOUS: Tractors Agrale, CBT, Fiat-Allis, Komatsu, Massey Perkins (to 85). Equipment Yanmar, Mercedes Benz;
SCANIA: Trucks, Bus, Marine Engine / Stationary;
TOYOTA: Bandeirantes and Utilitários (to 87);
VOLVO: Trucks N10, N12 e Bus B58 (to 85);
FIAT DIESEL: all models (to 82).
ALTERNATOR / ALTERNATOR:
BOSCH: 9 120 080 020, 9 120 080 031, 9 120 080 054, 9 120 080 084, 9 120 080 091, 9 120 080 082, 9 120 080 110, 9 120 080 125
VOLTAGE REGULATOR:
 GA004 / GA005

BOSCH
GA1089

FEATURES / CARACTERÍSTICAS: 65A, Diodes 6x35A, B+ Post M8x50, D+ Post M5x45, with diode trio
REPLACES / REEMPLAZA:
Bosch: 9 123 080 089; **Magneti Marelli:** PR520409
APPLICATION / APLICACIÓN:
FORD: Escort/ Verona 1.6i/ 1.8i without AC. (after 06.94), Royale/ Versailles 1.8i (AP) without AC. (to 01.93);
VW: Gol/ Parati/ Voyage 1.6i, 1.8i/ 2.0i (after 10.96), Logus 1.6i, 1.8 CL, GL, GLS, 1.8i/ 2.0i (AP) Pointer 1.6i, 1.8i, 2.0i (after 02.93), Santana/ Quantum 1.8i/ 2.0i/ 2.0i GLS without AC. (after 03.93).
ALTERNATOR / ALTERNATOR:
BOSCH: 9 120 080 501
VOLTAGE REGULATOR:
 GA039 / GA040

BOSCH
GA1128 // NEW //

FEATURES / CARACTERÍSTICAS: 150A, Avalanche Diodes 6x70A, B+ M8x22
REPLACES / REEMPLAZA:
Cargo: 333715; **AS-Poland:** ARC0137; **Transpo:** IBR2201; **Mobileron:** RB-170HD; **Regitar:** RB-170HD
APPLICATION / APLICACIÓN:
BMW: 540i V8 4.4 1999>2000, 740i V8 4.4 1999>2000, 750iL V12 5.4 1999>2000, X5 V8 4.4 2000; **LAND ROVER:** Range Rover III 4400 V8 2002>2005; **MERCEDES BENZ:** C200 2200 Cdi 2000>2003, C220 CDI 2.2 2000>2003, C270 2700 2000>2007, E200 CDI 2.2 1999>2000, E220 CDI 2.2 1999>2000, E270 CDI 2.7 1999>2001, E320 CDI 3.2 1999>2000, G400 CDI 4.0 2000>2015, S320 CDI 3.2 1999>2002, ML270 2700 2000>2005, S400 CDI 4.0 1999>2005
ALTERNATOR / ALTERNATOR:
BMW: 12-31-1-705-483, 12-31-1-705-557, 12-31-7-508-052, 12-31-7-508-054; **LAND ROVER:** YLE000040; **MERCEDES BENZ:** 000-150-06-50, 000-150-20-50, 000-150-28-50, 000-154-05-50, 000-154-06-50, 000-154-20-50, 0001500550, 137-150-05-50, 137-150-09-50, A0001500550, A0001500650, A0001502050, A0001502850, A1371500550, A1371500950



BOSCH

GA1129
FEATURES / CARACTERÍSTICAS: 65A, Diodes 6x35A, B+ Post M8x50, D+ Post M5x45, W Post M5x45, with diode trio

REPLACES / REEMPLAZA:
Bosch: 9 123 080 129; **Magneti Marelli:** PR520411

APPLICATION / APLICACIÓN:
VW: Gol 1.0 MI (AT 1000 MI Hitork 10.96).

ALTERNATOR / ALTERNATOR:
BOSCH: 9 120 080 502

VOLTAGE REGULATOR:

GA040

BOSCH

GA1012
FEATURES / CARACTERÍSTICAS: 70A, Diodes 6x35A, B+ Post M6x50, with diode trio

REPLACES / REEMPLAZA:
Bosch: F000 LD1-012; **Cargo:** 134341; **WAI/Transpo:** IBR301

APPLICATION / APLICACIÓN:
FORD: Pick-up F1000 HSD (Maxion High Speed) e F1000T (MWM-4.10T) (10.95) 9 120 080 230 K1 70 14;

MERCEDES BENZ: Sprinter 310D with enginer OM-014A without AC (09.96) 9 120 080 212 K1 70 14.

ALTERNATOR / ALTERNATOR:
BOSCH: 9 120 080 230, 9 120 080 212

VOLTAGE REGULATOR:

GA040

BOSCH

GA1652
FEATURES / CARACTERÍSTICAS: 85A, Diodes 6x35A, B+ Post M6, with diode trio

REPLACES / REEMPLAZA:
Bosch: 9 122 080 652; **Regitar:** RB-02; **Cargo:** 135605; **WAI/Transpo:** IBR304

APPLICATION / APLICACIÓN:
GM: Vectra 07>, S10, Blazer 2.2 05>, Kadet, Ipanema 89> with/ without AC

ALTERNATOR / ALTERNATOR:
BOSCH: 9 120 080 172, 9 120 080 180

VOLTAGE REGULATOR:

GA032

BOSCH

GA1027
FEATURES / CARACTERÍSTICAS: 70A, Diodes 6x35A Avalanche (Zener) , B+ Post M6

REPLACES / REEMPLAZA:
Bosch: 9 121 067 385, 9 120 067 027; **Regitar:** RB-83H; **Cargo:** 136591; **WAI/Transpo:** IBR388

APPLICATION / APLICACIÓN:
JOHN DEERE;
THERMOKING;
ALTERNATOR / ALTERNATOR:
BOSCH: 9 120 067 027; **LESTER:** 12223; **PIC:** 220344A; **THERMOKING:** 5D33839G01, 5D38603G01

BOSCH

GA1067
FEATURES / CARACTERÍSTICAS: 130A, Diodes 8x35A, Diode Avalanche (Zener)

REPLACES / REEMPLAZA:
Bosch: 9 121 067 067, 9 121 067 364, 9 121 067 371, 9 121 067 374, 9 121 067 375, 9 121 067 388, 9 121 067 394; **Regitar:** RB-84H;

Cargo: 234953; **WAI/Transpo:** IBR308

APPLICATION / APLICACIÓN:
FORD: Mercury, Capri

ALTERNATOR / ALTERNATOR:
BOSCH: 9 120 060 009, 9 120 060 023; **PIC:** 220344, 220344A, 220344C

VOLTAGE REGULATOR:

GA392

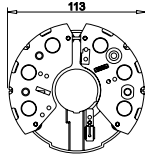
BOSCH
GA1275

FEATURES / CARACTERÍSTICAS: 75A, Diodes 6x35A, B+ Post M6x50.

REPLACES / REEMPLAZA:
Bosch: 9 122 080 275, 9 128 040 282, 1 127 011 117, 1 127 011 118, 1 127 011 119, 1 127 011 120, 1 127 011 121, 1 127 011 123, 1 127 011 124, 1 127 011 125, 1 127 011 128, 1 127 011 138, 1 127 011 140, 1 127 320 109, 1 127 320 110, 1 127 320 117, 1 127 320 128, 1 127 320 139, 1 127 320 148, 1 127 320 149, 1 127 320 150, 1 127 320 170, 1 127 320 171, 1 127 320 184, 1 127 320 187, 1 127 320 188, 1 127 320 189, 1 127 320 190, 1 127 320 195, 1 127 320 196, 1 127 320 197, 1 127 320 300, 1 127 320 301, 1 127 320 303, 1 127 320 304, 1 127 320 305, 1 127 320 306, 1 127 320 308, 1 127 320 309, 1 127 320 313, 1 127 320 318, 1 127 320 320, 1 127 320 325, 1 127 320 326;

Regitar: RB-02; **Cargo:** 130602; **WAI/Transpo:** IBR304; **Magneti Marelli:** PR520432

APPLICATION / APLICACIÓN:
GM: Chevette 1.6, Pick up D20, Bonanza, Veraneo Truck 12000 and 14000, Monza, Kadett and Ipanema;

FIAT: Spazio, Oggi, Uno, Prêmio, Uno Mille, Elba 1.3, Panorama, Fiat 147, Fiorino (after 10.79);

LADA: Niva, Laika.

ALTERNATOR / ALTERNATOR:
BOSCH: 0 120 400 740, 0 120 400 741, 0 120 400 828, 0 120 400 832, 0 120 400 850, 0 120 400 855, 0 120 400 921, 0 120 400 922, 0 120 400 928, 0 120 488 250, 0 120 488 073, 0 120 488 263, 0 120 488 637, 0 120 488 660, 0 120 488 668, 0 120 488 875, 0 120 488 882, 9 120 080 056, 9 120 080 089, 9 120 080 096, 9 120 080 098, 9 120 080 120, 9 120 080 141, 9 120 080 142, 9 120 080 143, 9 120 080 153, 9 120 080 165, 9 120 080 168, 9 120 080 169, 9 120 080 170, 9 120 080 171, 9 120 080 172, 9 120 080 173, 9 120 080 180, 9 120 080 186, 9 120 080 190, 9 120 080 191, 9 120 080 192, 9 120 080 194, 9 120 080 195, 9 120 080 198, 9 120 080 208, 9 120 080 211, 9 120 080 213, 9 120 080 216, 9 120 080 221, 9 120 080 224, 9 120 080 227, 9 120 080 228, 9 120 456 053

VOLTAGE REGULATOR:

GA026 / GA027 / GA028 / GA032 / GA034 / GA034R

BOSCH
GA1277

FEATURES / CARACTERÍSTICAS: 65A, Diodes 6x35A, with diode trio

REPLACES / REEMPLAZA:
Bosch: 9 122 080 277, 9 122 080 672, 9 122 080 276, 1 127 011 113, 1 127 011 112, 1 127 011 114, 1 127 011 115, 1 127 011 135, 1 127 011 101, 1 127 320 081, 1 127 320 105, 1 127 320 108, 1 127 320 103, 1 127 320 119, 1 127 320 120; **Regitar:** RB-01; **Cargo:** 130603; **WAI/Transpo:** IBR303; **Magneti Marelli:** PR520433

APPLICATION / APLICACIÓN:
FORD: Escort Ghia 1.8, Escort Xr3 1.8, Escort Guaruja 1.8, Del Rey 1.8, Belina 1.8, Pampa 1.8 and Verona 1.6, GLX 1.8;

VW: Gol 1000, Gol Plus 1000i, Gol 1.6, GL, GT, GTS 1.8, Parati e Voyage 1.5/ 1.6, Kombi diesel Apolo, Parati GL, GLS 1.8, Passat 1.5/ 1.6/ 1.8 / GTS, Pointer, Santana, Quantum 1.8/ 2.0 (to 12.91).

ALTERNATOR / ALTERNATOR:
BOSCH: 0 120 400 705, 0 120 400 758, 0 120 400 767, 0 120 400 811, 0 120 400 814, 0 120 489 501, 0 120 489 503, 0 120 489 509, 0 120 489 511, 0 120 489 513, 0 120 489 522, 0 120 489 532, 0 120 489 535, 0 120 489 917, 9 120 080 095, 9 120 080 099, 9 120 080 100, 9 120 080 108, 9 120 080 115, 9 120 080 116, 9 120 080 152, 9 120 080 163, 9 120 080 164, 9 120 080 176, 9 120 080 177, 9 120 080 178, 9 120 080 185, 9 120 080 206, 9 120 080 214

VOLTAGE REGULATOR:

GA022 / GA027 / GA028 / GA034 / GA034R

BOSCH
GA1283

FEATURES / CARACTERÍSTICAS: 65A, Diodes 8 x35A, B+ Post M6x50

REPLACES / REEMPLAZA:
Bosch: 1 127 320 690

APPLICATION / APLICACIÓN:
DODGE: Dynasty Plymont Voyager.

ALTERNATOR / ALTERNATOR:
BOSCH: 0 120 400 948, 0 120 400 950, 0 120 400 954, 0 120 400 947, 0 120 400 949, 5227249, 5233549

BOSCH
GA1310

FEATURES / CARACTERÍSTICAS: 85A, 6x35A Diodes, B+ Bolt M6, with diode trio, Ø 90mm

REPLACES / REEMPLAZA:
Bosch: 1125715027, 1125715034, 1127320017, 1127320115, 1127320141, 1127320142, 1127320146, 1127320316, 1127320317, 1127320345, 1127320393, 1127320569; **Regitar:** RB-13; **Cargo:** 132670; **WAI/Transpo:** IBR307

APPLICATION / APLICACIÓN:
JOHN DEERE
ALTERNATOR / ALTERNATOR:
BOSCH: 0120300535, 0120300552, 0120300562, 0120300567, 0120300575, 0120300576, 0120300577, 0120300578, 0120300579, 0120300580, 0120300585, 0120300586, 0120300589, 0120300590, 0120339511, 0120339512, 0120339513, 0120339514, 0120339521, 0120339531, 0120339532, 0120339535, 0120339536, 0120339537, 0120339538, 0120339542, 0120339543, 0120339544, 0120339545, 0120400504, 0120400554, 0120400555, 0120400558, 0120400563, 0120400566, 0120400567, 0120400568, 0120400569, 0120400570, 0120400571, 0120400572, 0120400836, 0120400837; **ISKRA:** AAG1301, AAG1302, AAG1304, AAG1310, AAG1311, AAG1315, AAG3315

BOSCH
GA1337

FEATURES / CARACTERÍSTICAS: 21A, 6x35A Bosch Press-fit standard diodes

REPLACES / REEMPLAZA:

Bosch: 9.121.080.998

APPLICATION / APLICACIÓN:

CATERPILLAR: Motor Grader (3306 wheel loader 930/966), Bulldozers D8L/D4E/D6D, Serie 120 B/C, 140 B/C 06.81>, Serie-930R 12.81>12.90, Serie 966C 02.82>12.90, Serie-3304 DIT / 3304 T / 3306 T 06.85>, Serie 3306 DIT 06.89>, Serie D4E-DD / NA / PS / SR / SA, Serie D6D-PS / DO / PS / DD 12.81>, Serie D5B-OS / DD 12.87>, Serie D6C 01.81>12.90, Série D6D-SA 07.83>12.90, D5B-OS / DD 06.91>;

CUMMINS: Serie N855, N855C, NT855, NT855C/G, NTA855, NTA855C, NTTA855

KOMATSU: D60E/F, D65E, D73E 08.89>

ALTERNATOR / ALTERNATOR:

BOSCH: 9120080128, 9120080174

BOSCH
GA1347

FEATURES / CARACTERÍSTICAS: 95A, Diodes 8x35A

REPLACES / REEMPLAZA:

Ford: E9YJ-10304A; **Regitar:** RB-82H; **Cargo:** 136556; **WAI/Transpo:** IBR347

APPLICATION / APLICACIÓN:

FORD: Mercury, Capri

ALTERNATOR / ALTERNATOR:

BOSCH: 9 120 060 027; **FORD:** 89JA10300AA, E9YJ10346A, E9YJ10346A; **LESTER:** 13300; **MOTORCRAFT:** GLE273, 220282

VOLTAGE REGULATOR:

GA392

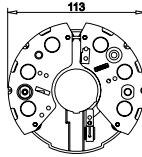
BOSCH
GA1638

FEATURES / CARACTERÍSTICAS: 75A, Diodes 6x35A, B+ Post M6x50, W Post M5/ M4x45, with diode trio

REPLACES / REEMPLAZA:

Bosch: 9 122 080 638

APPLICATION / APLICACIÓN:

FIAT ALLIS: Tractors FB80.2 e 100.2, série 4630, 5030, 5060, 6630, 7630, 7830, 8030 (01.97) F 000 LD0 103 K1 75 14;

GM: Pick-up D20, D40, D6000, Bonanza, Veraneio (Maxion) with AC (03.92) 9 120 080 197 K1 75 14.

ALTERNATOR / ALTERNATOR:

BOSCH: F000 LD0-103, 9 120 080 197

VOLTAGE REGULATOR:

GA028 / GA034 / GA034R

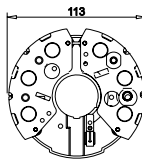
BOSCH
GA1651

FEATURES / CARACTERÍSTICAS: 65A, Diodes 6x35A, B+ Post Double Thread: M8/M6x50, D+ Post M5x45, with diode trio

REPLACES / REEMPLAZA:

Bosch: 1 127 320 651, 1 127 320 677; **Cargo:** 133996

APPLICATION / APLICACIÓN:

GM: Omega, Suprema 2.0i, 2.2i, 3.0i, (after 09.92) with AC.

ALTERNATOR / ALTERNATOR:

BOSCH: 0 120 488 156, 0 120 488 157, 0 120 488 158, 0 120 488 159, 0 120 488 160, 0 120 488 161, 0 120 488 162, 0 120 488 163, 0 120 488 164, 0 120 488 165, 0 120 488 167, 0 120 488 168, 0 120 488 169, 0 120 488 170, 0 120 488 171, 0 120 488 172, 0 120 488 173, 0 120 488 174, 0 120 488 175, 0 120 488 190, 0 120 488 191, 0 120 488 192, 0 120 488 193, 0 120 488 200, 0 120 488 201, 0 120 488 202, 0 120 488 203, 0 120 488 204

VOLTAGE REGULATOR:

GA028 / GA029

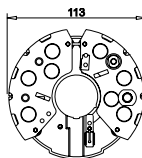
BOSCH
GA1676

FEATURES / CARACTERÍSTICAS: 95A, Diodes 8x35A, B+ Post M8x50, D+ Post M5x45, with diode trio

REPLACES / REEMPLAZA:

Bosch: 9 122 080 676

APPLICATION / APLICACIÓN:

FORD: Escort 2.0i Xr3

ALTERNATOR / ALTERNATOR:

BOSCH: 9 120 080 167

VOLTAGE REGULATOR:

GA028 / GA034 / GA034R

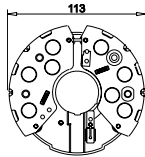
BOSCH
GA1677

FEATURES / CARACTERÍSTICAS: 85A, Diodes 8x35A Avalanche (Zener), B+ Post M8/M6x50, with diode trio

REPLACES / REEMPLAZA:

Bosch: F 000 LD1 006; **Magneti Marelli:** PR520511

APPLICATION / APLICACIÓN:

GM: S10 2.5L (after 10.95)(Maxxion High Speed with ACic.). Silverado 4.2 DLX (MWM with ACic.) (after 11.96). D6000, D6150 (after 11.96);

FORD: Pick-up Ranger 2.5D(Maxxion Hs4) (after 10.97);

MERCEDES BENZ: Sprinter 310/ 312/ 412.

ALTERNATOR / ALTERNATOR:

F000 LD0-102, F000 LD0-100, 9 120 080 232, 9 120 080 226

VOLTAGE REGULATOR:

GA021 / GA040

BOSCH
GA1692

FEATURES / CARACTERÍSTICAS: 95A, Diodes 8x35A Avalanche (Zener), B+ Post M8x50, D+ Post M5x45, W Terminal, With triodiode

REPLACES / REEMPLAZA:

Bosch: 1 127 320 692; **Cargo:** 138165; **Regitar:** RB-80H; **WAI/Transpo:** IBR324

APPLICATION / APLICACIÓN:

JOHN DEERE;

KHD;

NEW HOLLAND;

IVECO: 75-9A, 80-9A, 80-13A, 80-16A, 90-13A, 90-9A, 110-13A, 130-13A, 130-16A;

JI CASE : 110, 120, 135 with AC.

ALTERNATOR / ALTERNATOR:

BOSCH: 0 120 484 001, 0 120 484 011, 0 120 484 012, 0 120 484 015, 0 120 484 118, 0 120 484 020, 0 120 484 022, 0 120 484 024

VOLTAGE REGULATOR:

GA023

BOSCH
GA1717

FEATURES / CARACTERÍSTICAS: 50A, 6x35A, external diameter: 90mm

REPLACES / REEMPLAZA:

Bosch: 1 127 320 152, 1 127 320 192, 1 127 320 319

APPLICATION / APLICACIÓN:

FIAT: 128 L4 1.1 1971>1973, 128 L4 1.3 1972>1974, X-1/9 L4 1.3 1974

ALTERNATOR / ALTERNATOR:

BOSCH: 0 120 300 527, 0 120 300 528, 0 120 300 529, 0 120 300 551, 0 120 300 558, 0 120 300 568, 0 120 300 569, 0 120 300 746;

ALLIS-CHALMERS: 4998353; **FIAT:** 4224325, 4224325, 4257063, 4257074, 4257074, 4257771, 4275283, 4275283, 4325179,

4373600, 4373601, 4373601, 4383593, 4474729, 4474752, 4474752, 4474815, 4474816, 4475266, 4998353, 5101645, 5101707, 77175410,

77761410; **SAME:** 294390900; **STEYR:** 30800090021

BOSCH
GA1719

FEATURES / CARACTERÍSTICAS: 65A, 6x35A, B+: M8x34mm, External Diameter: 114mm

REPLACES / REEMPLAZA:

Bosch: 1 127 320 664, 1 127 320 665, 1 127 320 666, 1 127 320 945; **Cargo:** 132667; **As-Poland:** ARC0005; **Transpo:** IBR311;

Mobiletron: RB-04H; **Regitar:** RB-04

APPLICATION / APLICACIÓN:

AUDI EUROPE CAR: 100 Avant 2.0 1988>1990

VOLKSWAGEN: Derby 1.0/1.3 1983>1984, Golf Cabriolet 1.3 1983>1985, Golf II 1.6 Turbo 1989>1992, Golf II 1.3 1985>1988, Jetta 1.6

Turbo 1989>1992, Polo 1.3 1989>1992

ALTERNATOR / ALTERNATOR:

BOSCH: 0 120 488 134, 0 120 488 233

AUDI/ VOLKSWAGEN: 025903017X, 025903023A, 025903023B, 026903015A, 026903017A, 026903017AX

BOSCH
GA1923

FEATURES / CARACTERÍSTICAS: 90A, Diodes 6x35A, B+ Post M6x50

REPLACES / REEMPLAZA:

Bosch: 9 122 080 923; **Magneti Marelli:** PR520550

APPLICATION / APLICACIÓN:

RENAULT: Clio, Clio 1.6, 1595 R11, 1593 R9

ALTERNATOR / ALTERNATOR:

BOSCH: 9 120 080 215, 9 120 080 222, 9 120 080 231, F010 LD0 001

VOLTAGE REGULATOR:

GA306

BOSCH

GA1990

FEATURES / CARACTERÍSTICAS: 90A, Diodos 14x40A, with triode, B+ M8, D+ M5, Diameter 120mm

REPLACES / REEMPLAZA:

Bosch: 1127320172, 1127320359, 1127320360, 1127320531, 1127320542; **Regitar:** RB-45; **Cargo:** 132127; **WAI/Transpo:** IBR331

APPLICATION / APLICACIÓN:

VW: Golf, Passat Alemão;

AUDI, BMW, PORSCHE, MERCEDES BENZ

ALTERNATOR / ALTERNATOR:

BOSCH: 0120469500, 0120469501, 0120469502, 0120469503, 0120469504, 0120469505, 0120469524, 0120469525, 0120469528, 0120469533, 0120469538, 0120469539, 0120469551, 0120469552, 0120469553, 0120469554, 0120469555, 0120469556, 0120469557, 0120469558, 0120469560, 0120469561, 0120469593

BOSCH

GA1506

FEATURES / CARACTERÍSTICAS: 65A, Diodos 6x35A, "W" Terminal, with diode trio

REPLACES / REEMPLAZA:

Bosch: 1 127 320 506, 1 127 011 116, 1 127 320 614, 1 127 320 648; **Regitar:** RB-03; **Cargo:** 131559; **WAI/Transpo:** IBR302

APPLICATION / APLICACIÓN:

AUDI: Série 4000;

VW: Dasher, Jetta, Quantum, Rabbit, Scirocco, Diesel, Audi

ALTERNATOR / ALTERNATOR:

BOSCH: 0 120 489 080, 0 120 489 081, 0 120 489 082, 0 120 489 083, 0 120 489 186, 0 120 489 208, 0 120 489 210, 0 120 489 248, 0 120 489 249, 0 120 489 250, 0 120 489 282, 0 120 489 283, 0 120 489 470, 0 120 489 960, 0 120 489 961, 0 120 489 966, 0 120 489 967, 0 120 489 968, 0 120 489 996, 0 120 489 971, 0 120 489 972, 0 120 489 973, 0 120 489 974, 0 120 489 975, 0 120 489 976, 0 120 489 977, 0 120 489 978, 0 120 489 979, 0 120 489 980, 0 120 489 981, 0 886 031 501, 0 986 031 470, 0 986 031 480, 0 986 031 481, 0 986 031 500, 0 986 031 510, 0 986 033 340, 0 986 033 350, 0 986 034 190

BOSCH

GA1953

FEATURES / CARACTERÍSTICAS: 90A, Diodos 8x50, with diode trio, W Post M5, D+ M5, B+ M6

REPLACES / REEMPLAZA:

Bosch: 9 128 040 953, 9 128 040 953J; **Regitar:** RB-85H; **WAI/Transpo:** IBR668

APPLICATION / APLICACIÓN:

MERCEDES BENZ: Truck 94, alternator Bosch 9 120 180 020, 12V;

FORD: Bronco, Pegaso

ALTERNATOR / ALTERNATOR:

BOSCH: 9 120 180 020J

BOSCH

GA1336

FEATURES / CARACTERÍSTICAS: 35A, Diodos 6x35A, B+ Post M6x50, D+ Post M4x50, W Post M5x45, with diode trio

REPLACES / REEMPLAZA:

Bosch: 9 122 080 336

APPLICATION / APLICACIÓN:

MF: Tractor MF3640; (Perkins 6358A) (01.73) Trucks, Chassi for Bus OF e OH e Platform for Bus R, RS, RSD K1 35 28 Trucks, MicroBus, Engines Stationarys, Industrials, Generator and Marine OM.

ALTERNATOR / ALTERNATOR:

BOSCH: 9 120 080 148, 9 120 080 147, 9 120 080 502

VOLTAGE REGULATOR:

GA018 / GA018R / GA034 / GA034R / GA040

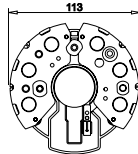
BOSCH

GA1366

FEATURES / CARACTERÍSTICAS: 95A, Diodos 6x35A, B+ Post M6x50, D+ Post M4x50, W Post M4x45, with diode trio

REPLACES / REEMPLAZA:

Bosch: 1 127 320 366, 1 127 320 545, 1 127 320 344, 1 127 320 363, 1 127 320 367, 1 127 320 546, 1 127 320 599, 1 127 011 098, 1 127 011 101; **Regitar:** RB-08; **Cargo:** 133138; **WAI/Transpo:** IBR313; **Magneti Marelli:** PR520444

APPLICATION / APLICACIÓN:

MERCEDES BENZ: Trucks 1113, 1313, 1316, 1513, 1516, 2013, 2213, 2216 (OM 352) with Power Steering, 1214, 1414, 1614, 1218, 1418, 1618, 1935, 1941 (OM 366, 366A, 447LA, 449A), 2220, 1524, 1525, L709, 712, 1520, 1621, 2020, Bus 364, 365, O365, Chassi for Bus LO812, OF and OH1113, 1313, OH1318;

KOMATSU: Tractors D30E, D50A, D50P;

MF: Tractors MF1630, 3640, 5650;

MAXION: Backhoe series 750 e Tractors 9150/ 9170;

TOYOTA: Utilitários Bandeirante;

DAF;

RENAULT;

STEYER;

SAAB;

SCANIA

ALTERNATOR / ALTERNATOR:

BOSCH: 0 120 489 027, 0 120 489 224, 0 120 489 053, 0 120 489 192, 0 120 489 230, 0 120 489 387, 0 120 489 388, 0 120 489 684, 0 120 489 702, 0 120 489 707, 0 120 489 710, 0 120 489 723, 0 120 489 726, 0 120 489 727, 0 120 489 733, 0 120 489 757, 0 986 030 660, 0 986 031 190, 0 986 031 230, 0 986 031 250, 0 986 031 251, 0 986 031 260, 0 986 031 290, 0 986 031 310, 0 986 031 330, 0 986 033 510, 0 986 033 570, 0 986 034 210, 0 986 034 350, 9 120 144 122, 9 120 144 123, 9 120 144 125, 9 120 144 127, 9 120 144 130, 9 120 144 131, 9 120 144 132, 9 120 144 133, 9 120 144 137

VOLTAGE REGULATOR:

GA018 / GA018R

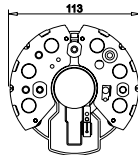

BOSCH
GA1508 // NEW //

FEATURES / CARACTERÍSTICAS: 45A, Diode 6x35A. PS: with trio diode

REPLACES / REEMPLAZA:

Bosch: 1 127 320 102, 1 127 320 114, 1 127 320 122, 1 127 320 124, 1 127 320 151, 1 127 320 327, 9 121 140 549; **Transpo:** IBR306; **Mobiletron:** RB11H; **Cargo:** 130596

APPLICATION / APLICACIÓN:

FIAT: 128 1.1 1971>1973, 128 1.3 1972>1974, X-1/9 1.3 1974

ALTERNATOR / ALTERNATOR:

BOSCH: 0 120 300 518, 0 120 300 519, 0 120 300 522, 0 120 300 523, 0 120 300 527, 0 120 300 528, 0 120 300 529, 0 120 300 532, 0 120 300 533, 0 120 300 540, 0 120 300 544, 0 120 300 545, 0 120 300 546, 0 120 300 547, 0 120 300 548, 0 120 300 549, 0 120 300 550, 0 120 300 551, 0 120 300 558, 0 120 300 559, 0 120 300 560, 0 120 300 563, 0 120 300 564, 0 120 300 568, 0 120 300 569, 0 120 300 587, 0 120 300 588, 0 120 300 591, 0 120 300 746, 0 120 339 502, 0 120 339 502, 0 120 339 503, 0 120 339 504, 0 120 339 505, 0 120 339 506, 0 120 339 509, 0 120 339 510, 0 120 339 517, 0 120 339 518, 0 120 339 519, 0 120 339 520, 0 120 339 522, 9 120 143 020, 9 120 143 207, 9 120 143 214, 9 120 143 215, 9 120 143 224;

FORD: 5003896, 71BB-10300-CA, 71BB-10300-CB, 71BB-10346-CA, 81AB-10300-SA, R78FB-10346-AC

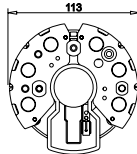
BOSCH
GA1509

FEATURES / CARACTERÍSTICAS: 95A, Diodes 6x35A, B+ Post M6x50, D+ Post M4x50, W Post M5x45, with diode trio

REPLACES / REEMPLAZA:

Bosch: 9 122 080 509

APPLICATION / APLICACIÓN:

JI CASE: Tractors W18D e W20D (OM 366A) (93 / 94);

KOMATSU: Tractors D30E (OM 352), D50A, D50P (OM 352A) (05.75);

MASSEY-FERGUSON: Tractor MF3640 (Perkins 6358A);

MERCEDES BENZ: Truck 1620 (06.96) Trucks 1113, 1114, 1117, 1118, 1313, 1314, 1514, 1520, 2014, 2020, 2214 (OM 352) Trucks 1214, 1218, 1414, 1418, 1614, 1618, 1924, 1929, 1932, 1933, 1934, 1935;

TOYOTA: Utilitário Bandeirante.

ALTERNATOR / ALTERNATOR:

BOSCH: 9 120 080 181, 9 120 080 183, 9 120 080 219

VOLTAGE REGULATOR:

GA018 / GA018R / GA034 / GA034R

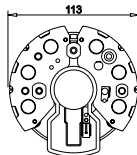
BOSCH
GA1541

FEATURES / CARACTERÍSTICAS: 95A, Diodes 6x35A, B+ Post M6x50, D+ Post M4x50, W Post M5x45, with diode trio

REPLACES / REEMPLAZA:

Bosch: 1 127 320 541, 1 127 011 095; **Regitar:** RB-07; **Cargo:** 131468; **WAI/Transpo:** IBR314; **Magneti Marelli:** PR520494

APPLICATION / APLICACIÓN:

SCANIA: Trucks T112 e 142, R112, 113 e 142, DN 11, Ds11 e 14, Marine Engine Geradores Ind;

MERCEDES BENZ: Trucks O365, 812, 1621, 2020, L1625, LG1825,1114, 1214, 1418;

MAXION: Backhoe series 1175, MF86, Tractors 9070, 9075, 9090, 9110, 9130 w/ engine Perkins;

MF: Tractors MF1630, 3640, 5650, 5650 Turbo, 6845, 6855 e 6865, 235, 265, 272, 275, 283, 290, 292, 297, 299;

KOMATSU: Tractors D30E after 11/78;

JI CASE: Tractors W36B (after 01/88)

ALTERNATOR / ALTERNATOR:

BOSCH: 0 120 489 728, 0 120 489 730, 0 120 489 827, 0 120 489 886, 0 120 489 944, 9 120 080 114, 9 120 080 130, 9 120 080 136, 9 120 080 137, 9 120 080 144, 9 120 080 157, 9 120 080 159, 9 120 080 160, 9 120 080 162, 9 120 080 166, 9 120 080 182, 9 120 080 184, 9 120 080 187, 9 120 080 188, 9 120 080 202, 9 120 080 207

VOLTAGE REGULATOR:

GA018 / GA018R / GA034 / GA034R

BOSCH
GA1909

FEATURES / CARACTERÍSTICAS: 120A, Diodes 6x50A, B+ Post M8x30, L Post M4x19, W Post M5x19, with diode trio

REPLACES / REEMPLAZA:

Bosch: 1 127 320 909, 1 127 320 992, 9 127 041 132, 9 127 041 133; **Mercedes Benz:** 000 154 7016; **Cargo:** 133995; **Regitar:** RB-14; **WAI/Transpo:** IBR315

APPLICATION / APLICACIÓN:

MERCEDES BENZ: Trucks

ALTERNATOR / ALTERNATOR:

BOSCH: 0 120 489 316

BOSCH
GA1320

FEATURES / CARACTERÍSTICAS: 85A, Diodes 6x35A, with diode trio

REPLACES / REEMPLAZA:

Bosch: 9 121 067 300, 9 121 067 303, 9 121 067 304, 9 121 067 317, 9 121 067 319, 9 121 067 320, 9 121 067 324, 9 121 067 325, 9 121 067 328, 9 121 067 329, 9 121 067 330, 9 121 067 331; **WAI/Transpo:** IBR310

APPLICATION / APLICACIÓN:

GM: Chevy Luv 2.2 98>

ALTERNATOR / ALTERNATOR:

BOSCH: 9 120 060 910

VOLTAGE REGULATOR:

GA375

BOSCH
GA1321

FEATURES / CARACTERÍSTICAS: 85A, Diodes 6x35A
REPLACES / REEMPLAZA:
Bosch: 9 121 067 301, 9 121 067 316; **Lucas:** UBB 416
APPLICATION / APLICACIÓN:
DODGE: Omni;
 Chrysler with engine Peugeot
ALTERNATOR / ALTERNATOR:
BOSCH: 9 120 060 684; **LESTER:** 13187, 14787; **PIC:** 220125, 220184

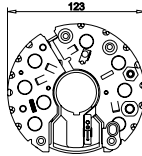
BOSCH
GA1701

FEATURES / CARACTERÍSTICAS: 115A, Diodes 8x50A, B+ Post M8x50, W Terminal, with diode trio
REPLACES / REEMPLAZA:
Bosch: 1 127 320 701, 1 127 320 708, 1 127 320 731; **Audi:** 075 903 359; **Lucas:** UBB432; **Cargo:** 134003;
Magneti Marelli: 940 038 206; **Regitar:** RB-56H; **WAI/Transpo:** IBR357
APPLICATION / APLICACIÓN:
VW: alternators Bosch série 469 IR/EF 115A.
ALTERNATOR / ALTERNATOR:
BOSCH: 0 120 469 601, 0 120 469 602, 0 120 469 604, 0 120 469 605, 0 120 469 637, 0 120 469 638, 0 120 469 654, 0 120 469 674, 0 120 469 675, 0 120 469 701, 0 120 469 702, 0 120 469 703, 0 120 469 704, 0 120 469 705, 0 120 469 706, 0 120 469 707, 0 120 469 711, 0 120 469 714, 0 120 469 717, 0 120 469 718, 0 120 469 719

BOSCH
GA1702

FEATURES / CARACTERÍSTICAS: 120A, Diodes 6x50A, with diode trio
REPLACES / REEMPLAZA:
Bosch: 1 127 320 702, 1 127 320 709, 1 127 320 722, 1 127 320 733; **Regitar:** RB-55; **Cargo:** 133261; **WAI/Transpo:** IBR355
APPLICATION / APLICACIÓN:
BMW: 525i, 528i, 533, 535, 628, 635, 728, 732, 733, 735, 745, 316, 318, 320, 323, 325e, 518, 520, 525, 535, 628, 635, 728, 732, 735, 745, 528, Z1;
SAAB: 900, 9000;
MERCEDES BENZ: 500 SL, 300 SD;
SL LAMBORGHINI: Countach 5 S, Diablo 5.7, LM i29 5.2;
FERRARI: 328GTB, Mondial 8 85-87
ALTERNATOR / ALTERNATOR:
BOSCH: 0 120 469 644, 0 120 469 645, 0 120 469 682, 0 120 469 683, 0 120 469 684, 0 120 469 685, 0 120 469 880, 0 120 469 881

BOSCH
GA1703

FEATURES / CARACTERÍSTICAS: 100A, Diodes 8x35, with diode trio, B+ M8 + M6, trio M5, OD 120mm
REPLACES / REEMPLAZA:
Bosch: 1127320716; **Volvo:** 3515707
APPLICATION / APLICACIÓN:
VOLVO: Serie 740 2.4 diesel 1984-1992, Serie 760 /780 Diesel 1987-1992, Serie 940 /960 2.4 diesel
ALTERNATOR / ALTERNATOR:
BOSCH: 0120469788, 0120469789, 0120469015, 0120469020, 0120469021, 0120469610, 0120469722, 0120469723, 0120469724, 0120469734, 0120469735, 0120469736, 0120469737, 0120469738, 0120469739, 0120469740, 0120469741, 0120469774, 0120469788, 0120469789, 0120469813, 0120469814, 0120469831, 0120469856, 0120469857, 0120469863, 0120469884, 0120469903, 0120469904, 0120469908, 0120469931, 0120469932, 0120469933, 0120469934, 0120469935, 0120469975, 0120469976, 0120469977, 0120469991, 0120469996

BOSCH
GA1704

FEATURES / CARACTERÍSTICAS: 100A, Diodes 8x35, with diode trio, B+ M8, trio M5, OD 120mm
REPLACES / REEMPLAZA:
Bosch: 1 127 320 720, 1 127 320 741, 1 127 320 911; **Cargo:** 136372
APPLICATION / APLICACIÓN:
BMW: 525i /530i /535i 1988-1991, 730 /735i 1986-1994
ALTERNATOR / ALTERNATOR:
BOSCH: 0120469176, 0120469775, 0120469776, 0120469989, 0120469990

BOSCH
GA1705

FEATURES / CARACTERÍSTICAS: 75A, Diodes 6x35 B+ M6, trio M4, W-M5, with terminal aux. with diode trio, OD 114mm
REPLACES / REEMPLAZA:
Bosch: 1 127 320 667; **Ford:** 86AB10304AA; **Regitar:** RB-38H; **Cargo:** 135890; **WAI/Transpo:** IBR667
APPLICATION / APLICACIÓN:
FORD: Escort /Fiesta /Orion 1976-2001
ALTERNATOR / ALTERNATOR:
CATERPILLAR: 1008223; **PERKINS:** 2871C105; **BOSCH:** 0120488286, 0120489347, 0120489389, 0120489390, 0120489391, 0120489392, 0120489408

BOSCH
GA1706

FEATURES / CARACTERÍSTICAS: 130A, Diodes 8x50A, with diode trio

REPLACES / REEMPLAZA:

Bosch: 1 127 320 706; **Cargo:** 134002; **Ford:** 6153350, 85GB10304CA, 86GB10304CA; **Lucas:** 2131044, UBB405; **Regitar:** RB-53; **Cargo:** 134002; **WAI/Transpo:** IBR353

APPLICATION / APLICACIÓN:

FORD: Granada, Scorpio, Sierra, Transit, Merkur

ALTERNATOR / ALTERNATOR:

BOSCH: 0 120 469 009, 0 120 469 032, 0 120 469 659, 0 120 469 660, 0 120 469 661, 0 120 469 662, 0 120 469 713, 0 120 469 747, 0 120 469 748, 0 120 469 871, 0 120 469 874, 0 120 469 899, 0 120 469 958, 0 986 034 140, 0 986 036 000; **FORD:** 85GX10300LA, E7RY10346A; **LESTER:** 14944; **MOTORCRAFT:** GLE245; **PIC:** 220197

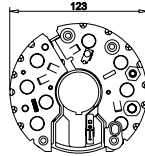
BOSCH
GA1708

FEATURES / CARACTERÍSTICAS: 115A, Diodes 8x50A, B+ Post M8x50, D+ Post M5x45, W Terminal, with diode trio

REPLACES / REEMPLAZA:

Bosch: 1 127 320 708, 1 127 320 731; **Regitar:** RB-56H; **Cargo:** 134003; **WAI/Transpo:** IBR357

APPLICATION / APLICACIÓN:

MERCEDES BENZ; SAAB; VOLVO; BMW; VOLKSWAGEN; AUDI;

ALTERNATOR / ALTERNATOR:

BOSCH: 0 120 469 603, 0 120 469 610, 0 120 469 015, 0 120 469 020, 0 120 469 021, 0 120 469 663, 0 120 469 722, 0 120 469 723, 0 120 469 724, 0 120 469 734, 0 120 469 735, 0 120 469 736, 0 120 469 737, 0 120 469 738, 0 120 469 739, 0 120 469 740, 0 120 469 741, 0 120 469 768, 0 120 469 774, 0 120 469 813, 0 120 469 814, 0 120 469 856, 0 120 469 857, 0 120 469 863, 0 120 469 884, 0 120 469 903, 0 120 469 904, 0 120 469 908, 0 120 469 929, 0 120 469 930, 0 120 469 931, 0 120 469 932, 0 120 469 933, 0 120 469 934, 0 120 469 953, 0 120 469 975, 0 120 469 976, 0 120 469 977, 0 120 469 991

VOLTAGE REGULATOR:

GA025 / GA026

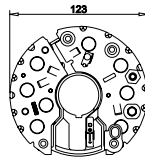
BOSCH
GA1710

FEATURES / CARACTERÍSTICAS: 115A, Diodes 8x50A, with diode trio, B+ Post M8x50, D+ Post M5x45, D+ Post M5x45,

With triodiode

REPLACES / REEMPLAZA:

Bosch: 1 127 320 710, 1 127 320 565, 1 127 320 732, 1 127 320 681, 1 127 320 737, 1 127 320 705, 1 127 320 723, 1 127 320 739; **Regitar:** RB-54; **Cargo:** 233778; **WAI/Transpo:** IBR354

APPLICATION / APLICACIÓN:

VW: Santana;

FORD: Royale and Versailles with AC (AP) after 03/92;

ALFA ROMEO; AUDI; BMW; MERCEDES BENZ; VOLVO; PORSCHE; SAAB;

ALTERNATOR / ALTERNATOR:

BOSCH: 0 120 427 988, 0 120 468 018, 0 120 468 020, 0 120 468 022, 0 120 468 024, 0 120 468 025, 0 120 468 026, 0 120 468 027, 0 120 468 029, 0 120 468 044, 0 120 468 052, 0 120 468 056, 0 120 468 068, 0 120 468 069, 0 120 468 070, 0 120 468 079, 0 120 468 101, 0 120 468 106, 0 120 468 108, 0 120 468 109, 0 120 468 121, 0 120 468 123, 0 120 468 125, 0 120 468 126, 0 120 469 002, 0 120 469 003, 0 120 469 011, 0 120 469 012, 0 120 469 016, 0 120 469 017, 0 120 469 589, 0 120 469 590, 0 120 469 591, 0 120 469 642, 0 120 469 648, 0 120 469 649, 0 120 469 676, 0 120 469 677, 0 120 469 690, 0 120 469 709, 0 120 469 725, 0 120 469 726, 0 120 469 729

VOLTAGE REGULATOR:

GA021 / GA029

BOSCH
GA1713

FEATURES / CARACTERÍSTICAS: 120A, Diodes 6x50A, with diode trio

REPLACES / REEMPLAZA:

Bosch: 1 127 320 713; **Cargo:** 138620; **Valeo:** 1398640

APPLICATION / APLICACIÓN:

VOLVO: 740, 760, 780, 940, 960

ALTERNATOR / ALTERNATOR:

BOSCH: 0 120 468 009, 0 120 468 010, 0 120 468 011, 0 120 468 012, 0 120 468 015, 0 120 468 016

BOSCH
GA1718

FEATURES / CARACTERÍSTICAS: 120A, Diodes 6x50A

REPLACES / REEMPLAZA:

Bosch: 1 127 320 718, 1 127 320 719, 1 127 320 729, 1 127 320 748; **Cargo:** 138987; **Chrysler:** 5 226 600; **Regitar:** RB-75H; **WAI/Transpo:** IBR329

APPLICATION / APLICACIÓN:

CHRYSLER: ES 2.2i turbo, ES 2.5i turbo, GSII turbo, GTS 2.2i T, Lancer 2.2, 2.5, LeBaron 2.2i T, 2.5i T, Saratoga 3.0i, Voyager 3.3 V6, 3.8 V6 Dodge

ALTERNATOR / ALTERNATOR:

BOSCH: 0 120 450 011, 0 120 450 012, 0 120 450 013, 0 120 450 014, 0 120 450 016, 0 120 450 017, 0 120 450 019, 0 120 450 020;

LESTER: 13315, 14789; **PIC:** 220123, 220124, 220270, 220270A

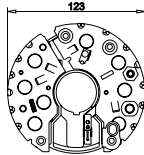
BOSCH
GA1730

FEATURES / CARACTERÍSTICAS: 115A, Diodes 8x50A, B+ Post M8x50, with diode trio

REPLACES / REEMPLAZA:

Bosch: 1 127 320 700, 1 127 320 730; **Regitar:** RB-51; **Cargo:** 132103; **WAI/Transpo:** IBR351

APPLICATION / APLICACIÓN:

FIAT: Tipo, Tempra Argentino, Tempra Turbo 2.0i with AC after 04/94;

AUDI; FORD

ALTERNATOR / ALTERNATOR:

BOSCH: 0 120 469 028, 0 120 469 029, 0 120 469 034, 0 120 469 035, 0 120 469 631, 0 120 469 632, 0 120 469 633, 0 120 469 635, 0 120 469 636, 0 120 469 637, 0 120 469 671, 0 120 469 672, 0 120 469 696, 0 120 469 697, 0 120 469 698, 0 120 469 699, 0 120 469 700, 0 120 469 708, 0 120 469 712, 0 120 469 715, 0 120 469 716, 0 120 469 720, 0 120 469 847, 0 120 469 848, 0 120 469 859, 0 120 469 860, 0 120 469 861, 0 120 469 875, 0 120 469 892, 0 120 469 893, 0 120 469 937, 0 120 469 939, 0 120 469 940, 0 120 469 979, 0 120 469 980, 0 120 469 981

VOLTAGE REGULATOR:

GA026

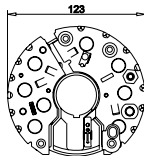
BOSCH
GA1735

FEATURES / CARACTERÍSTICAS: 115A, Diodes 8x50, B+ Post M8/M6x50, D+ Post M5x45, with diode trio

REPLACES / REEMPLAZA:

Bosch: 1 127 320 712, 1 127 320 713, 1 127 320 735; **Regitar:** RB-58; **Cargo:** 138164; **WAI/Transpo:** IBR712

APPLICATION / APLICACIÓN:

GM: Ómega, Suprema 2.0i, 2.2i, 3.0i with AC (after 03.93).

ALTERNATOR / ALTERNATOR:

BOSCH: 0 120 469 784, 0 120 469 785, 0 120 469 786, 0 120 469 787, 0 120 469 793, 0 120 469 882, 0 120 469 883, 0 120 469 909, 0 120 469 910, 0 120 469 915, 0 120 469 916, 0 120 469 923, 0 120 469 924, 0 120 469 935, 0 120 469 988

VOLTAGE REGULATOR:

GA029

BOSCH
GA1736

FEATURES / CARACTERÍSTICAS: 130A, Diodes 8x50A, B+ Post M6/M8x50, D+ Post M5x45, W Terminal, with diode trio

REPLACES / REEMPLAZA:

Bosch: 9 128 041 566

APPLICATION / APLICACIÓN:

CUMMINS;

NAVISTAR 100A

ALTERNATOR / ALTERNATOR:

BOSCH: 6 004 LA9

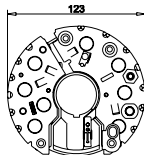
BOSCH
GA1753

FEATURES / CARACTERÍSTICAS: 80A, Diodes 8x35A Avalanche (Zener), B+ Post M8/M6x50, D+ Post M5/M4x45, W Post M5x45, With triodiode

REPLACES / REEMPLAZA:

Bosch: 1 127 320 753; **Regitar:** RB-93H; **Cargo:** 231451, 137724; **WAI/Transpo:** IBR753; **Magneti Marelli:** PR520528

APPLICATION / APLICACIÓN:

MERCEDES BENZ: Bus OF1417, 915, Equipment with OM 904 LA 4 cylinders.

ALTERNATOR / ALTERNATOR:

BOSCH: 0 120 468 143, 0 120 468 145, 0 120 469 101, 0 120 469 115, 0 120 469 116, 0 120 469 117, 0 120 469 118, 6033G004BY, 6033G3B022, 6033GB3010, 6033GB3019, 6033GB3022, 6033GB3023, 6033GB3027

BOSCH
GA1412

FEATURES / CARACTERÍSTICAS: 130A, Avalanche Diodes 6x50A, B+ Bolt M8x22mm (L), B+ Bolt M6x32mm (R), Ø 120mm

REPLACES / REEMPLAZA:

Bosch: F 00M 113 212

APPLICATION / APLICACIÓN:

FORD: Ka, Fiesta 1.0, Courier

ALTERNATOR / ALTERNATOR:

BOSCH: 0 124 225 038

VOLTAGE REGULATOR:

GA235

BOSCH

GA1413

FEATURES / CARACTERÍSTICAS: 120A, 6x50A, Avalanche Diodes, B+ M8X30mm

REPLACES / REEMPLAZA:

Bosch: F 000 BL2 106

APPLICATION / APLICACIÓN:

FIAT: Ducato, Iveco Daily;

PEUGEOT: Boxer

ALTERNATOR / ALTERNATOR:

Bosch: F000 BLO 706, F 000 BLO 7R9

VOLTAGE REGULATOR:

GA343

BOSCH

GA1414

FEATURES / CARACTERÍSTICAS: 110A, 6X50A Avalanche Diodes

REPLACES / REEMPLAZA:

...

APPLICATION / APLICACIÓN:

Ford: Ranger 2012, EcoSport 1.5 TDCi/ 1.5 Ti, EcoBoost 1.0 2013>

ALTERNATOR / ALTERNATOR:

Bosch: F000 BLO 606;

Fomoco: AB39 10300 BE, L566-18300-A

BOSCH

GA1415

FEATURES / CARACTERÍSTICAS:

REPLACES / REEMPLAZA:

...

APPLICATION / APLICACIÓN:

Ford: Nova Eco Sport 2.0, Ranger 2013

ALTERNATOR / ALTERNATOR:

Bosch: F 000 BLO 643

Ford: CN15-10300-AB

BOSCH

GA1416

FEATURES / CARACTERÍSTICAS: 85A, Diodes 6x35A Avalanche, 103mm

SUBSTITUI:

Bosch: F 000 BL1 002

APLICAÇÃO:

VW: CrossFox (Fase I) 1.6 Total Flex 2008>2009, CrossFox (Fase II) 1.6 Total Flex >2009, Fox (Fase I) 1.0 Total Flex 2008>2009, Fox 1.6 Total Flex 2008>2009, Fox (Fase II) 1.0 Total Flex 2009>2014, Fox 1.6 I Motion Total Flex >2009, Fox 1.6 Total Flex >2009, Gol II 1.0Mi 8V 1996>1999, Gol II Special 1.0Mi 8V 1999>2005, Gol III 1.0Mi 1999>2005, Gol III 1.0Mi 16V 1999>2005, Gol III 1.0Mi 16V Turbo 2000>2003, Gol III 1.0Mi Total Flex 2005>2006, Gol IV 1.0 2005>2008, Gol IV 1.0 Total Flex 2005>2013, Gol IV 1.0 Ecomotion 2010>2013, Gol V 1.0 Total Flex 2008>2012, Gol V 1.6 Total Flex 2008>2012, Gol VI 1.0 Total Flex >2012, Gol VI 1.6 I-Motion Total Flex >2012, Gol VI 1.6 Total Flex >2012, Golf III 2.0Mi 1994>1998, Parati II 1.0Mi 16V 1997>1999, Parati III 1.0Mi 16V 1999>2003, Parati III 1.0Mi 16V Turbo 2000>2004, Polo 1.6 Total Flex >2008, Polo Sedan 1.6 Total Flex >2008, Saveiro V 1.6 Total Flex >2009, Space Cross 1.6 Total Flex >2011, SpaceFox (Fase I) 1.6 Total Flex 02008>2010, SpaceFox (Fase II) 1.6 Total Flex >2010, Voyage (Fase I) 1.6 1989>1993, Voyage (Fase II) 1.0 Flex >2012, Voyage 1.0 Total Flex 2008>2012, Voyage 1.6 Flex >2012, Voyage 1.6 I Motion Flex >2012, Voyage 1.6 Total Flex 2008>2012

ALTERNADOR:

BOSCH: F000BL0300, F000BL0418, F000BL0400, F000BL0301, F000BL04C0; **VW:** 5U0903025E, 5U0903025D

CONJUNTO REGULADOR:

GA343 / GA363

BOSCH

GA1417

FEATURES / CARACTERÍSTICAS:

REPLACES / REEMPLAZA:

...

APPLICATION / APLICACIÓN:

Fiat: Punto, Linea, Bravo, Dobló, Siena, Strada Trekking, Idea, Palio Hatch, Palio Adventure, Palio Weekend (All 1.6 and 1.8 16V E-Tork 2010>).

ALTERNATOR / ALTERNATOR:

BOSCH: F 000 BLO 609, F 000 BLO 700

BOSCH
GA1418

FEATURES / CARACTERÍSTICAS: 110A, 6x50A Avalanche Diodes
REPLACES / REEMPLAZA:
Bosch: F 000 BL1 069
APPLICATION / APLICACIÓN:
Fiat: Uno, Palio, Siena, Strada, Fiorino
ALTERNATOR / ALTERNATOR:
BOSCH: F 000 BLO 600

BOSCH
GA1419

FEATURES / CARACTERÍSTICAS: 120A, 6x50A Avalanche Diodes
REPLACES / REEMPLAZA:
 -
APPLICATION / APLICACIÓN:
Mercedes: Sprinter 310, 311, 315, 415, 515 (CDI).
ALTERNATOR / ALTERNATOR:
BOSCH: F 000 BLO 732;
MERCEDES BENZ: 000 906 04 22

BOSCH
GA1449

FEATURES / CARACTERÍSTICAS: 130A, 6x50A, Avalanche Diode, B+: M8x20mm
REPLACES / REEMPLAZA:
 -
APPLICATION / APLICACIÓN:
GM: Prisma e Onix 1.0/1.4, Cobalt 1.8 LTZ, S10 2.5 Flex
ALTERNATOR / ALTERNATOR:
BOSCH: F 000 BLO 7T1
GM: 52076121
VOLTAGE REGULATOR:
 GA352

BOSCH
GA1420

FEATURES / CARACTERÍSTICAS: 120A, Diodes 6x50A Avalanche (Zener), Ø: 120mm
REPLACES / REEMPLAZA:
Bosch: F 00M 133 200; **Cargo:** 231714; **WAI/Transpo:** IBR200
APPLICATION / APLICACIÓN:
PORSCHE: 911 3.6 GT3, Boxter 2.5, Carrera 3.4, GT3 3.6;
OPEL: Astra G 2.0, Zafira 2.0 DTH 16V
ALTERNATOR / ALTERNATOR:
BOSCH: 0 124 515 001, 0 124 515 008, 0 124 515 015, 0 124 515 016, 0 124 515 043, 0 124 515 058, 0 124 525 016, B 120 516 147;
VW: 038 903 018F

BOSCH
GA1421

FEATURES / CARACTERÍSTICAS: 90A, Diodes 6x35A Avalanche (Zener), Ø: 120mm
REPLACES / REEMPLAZA:
Bosch: F 00M 123 228; **Magneti Marelli:** PR520463
APPLICATION / APLICACIÓN:
ROVER: 25 1.4, 1.6, 1.8, 45, 1.6, 1.8; **VW:** Beetle 1.9 TDI, Bora, Golf, Lupo, Polo Classic, Caravelle; **AUDI:** A3 1.6, 1.9 TDI quattro;
SEAT: Arosa 1.4 TDI, Cordoba, Leon, Toledo; **MERCEDES BENZ:** vehicles, Kompressor, Sprinter 2.7, 715C (ACCELLO);
VOLVO: vehicles
ALTERNATOR / ALTERNATOR:
BOSCH: 0 124 315 003, 0 124 325 003, 0 124 225 010, 0 124 225 012, 0 124 415 010
VOLTAGE REGULATOR:
 GA225 / GA261 / GA282

BOSCH
GA1422

FEATURES / CARACTERÍSTICAS: 120A, Diodes 6x50A Avalanche (Zener)
REPLACES / REEMPLAZA:
Bosch: F 00M 133 201, F 00M 133 205, F 00M 133 228, F 00M 133 241, F 00M 133 246, F 00M 123 201, F 00M 123 212, F 00M 123 227;
Regitar: RB-119H; **Mobiletron:** RB-119H; **Cargo:** 333557; **WAI/Transpo:** IBR201; **AS Poland:** ARC0043
APPLICATION / APLICACIÓN:
AUDI: A2 1.4, A3 1.6, TT Coupe 1.8, A4, A6;
FORD: Galaxy 1.9;
SEAT: Alhambra 1.8, 1.9, 2.0, Arosa 1.4, Córdoba 1.9, Ibiza 1.9, Leon 1.9, Toledo;
SKODA: Fabia 1.9, Octavia;
VW: Beetle 1.9, 2.0, Bora, Golf, Lupo, Polo, Polo Classic, Sharan, Caravelle, Passat;
VOLVO: vehicles;
MERCEDES BENZ: vehicles
ALTERNATOR / ALTERNATOR:
BOSCH: 0 124 225 010, 0 124 315 010, 0 124 315 014, 0 124 320 001, 0 124 325 017, 0 124 325 019, 0 124 325 020, 0 124 325 036,
 0 124 325 037, 0 124 325 039, 0 124 325 040, 0 124 325 043, 0 124 325 045, 0 124 325 055

BOSCH
GA1423

FEATURES / CARACTERÍSTICAS: 120A, Diodos Avalanche (Zener) 6x50A

REPLACES / REEMPLAZA:

Bosch: F 00M 133 224, F 00M 133 286; **Regitar:** RB-117H; **Cargo:** 235051; **WAI/Transpo:** IBR224; **Magneti Marelli:** PR520465

APPLICATION / APLICACIÓN:

VW: Truck 16.210 CO;

MERCEDES BENZ: Truck L1622, LS1938, LS2638, O500M, OF1620, OF1721, OH1420, OH1621 LG, 915, 917, 1218, 1418, 1622, 1944, 1114, 1117, 1120, 1124, 1215, 1315, 1317, 1318, 1418, 1518, 1718, 1725, 1728, 2423, 2425, 2428, 712, 814, 817;

EL DETALLE: Truck AO 101 w/ engine BF 6-913C;

IVECO: 70 E 21;

VW: 13170, 13180, 15170, 15180, 15190, 17210, 17250, 18310, 23250, 24250, 26260, 31260, 8150, 9150, Constallation 17250, 19320, Titan 24250, 31320

ALTERNATOR / ALTERNATOR:

BOSCH: 0 124 555 001, 0 124 555 002, 0 124 555 007, 0 124 555 015, 0 124 655 026, 0 124 655 007, 0 124 055 004

VOLTAGE REGULATOR:

GA231 / GA298 / GA300

BOSCH
GA1424

FEATURES / CARACTERÍSTICAS: 120A, Diodos 6x50A Avalanche (Zener)

REPLACES / REEMPLAZA:

Bosch: F 00M 113 202; **Magneti Marelli:** PR520466

APPLICATION / APLICACIÓN:

FIAT: Palio, Palio Weekend, Siena 1.0, 1.5 MPI 8V, Strada;

MERCEDES BENZ: Classe A 160;

IVECO: City Class, Daily, Scudato;

GM: Safira

ALTERNATOR / ALTERNATOR:

BOSCH: 4315002, 0 124 215 006, 0 124 315 003, 0 124 315 004, 0 124 315 005, 0 124 315 006, 0 124 315 007, 0 124 315 008, 0 124 315 010, 0 124 315 011, 0 124 315 012, 0 124 315 013, 0 124 315 014, 0 124 315 018, 0 124 315 020, 0 124 315 021, 0 124 315 022, 0 124 320 001, 0 124 325 001, 0 124 325 002, 0 124 325 003, 0 124 325 004, 0 124 325 011, 0 124 325 012, 0 124 325 013, 0 124 325 014, 0 124 325 015, 0 124 325 016, 0 124 325 017, 0 124 325 018, 0 124 325 019, 0 124 325 020, 0 124 325 021, 0 124 325 022, 0 124 325 023, 0 124 325 032, 0 124 325 033, 0 124 325 034, 0 124 325 035, 0 124 325 036, 0 124 325 037, 0 124 325 039, 0 124 325 040, 0 124 325 041, 0 124 325 042, 0 124 325 043, 0 124 325 045, 0 124 325 049, 0 124 415 001, 0 124 415 002, 0 124 415 005, 0 124 415 006, 0 124 415 008, 0 124 415 009, 0 124 415 010, F 000 LD0 700

VOLTAGE REGULATOR:

GA225 / GA234 / GA261 / GA282

BOSCH
GA1425

FEATURES / CARACTERÍSTICAS: 90A, Diodos 6x35A Avalanche (Zener)

REPLACES / REEMPLAZA:

Bosch: F 00M 123 207; **Magneti Marelli:** PR520467

APPLICATION / APLICACIÓN:

FIAT: Palio, Siena, Uno, Palio Weekend and Weekend 1.7TD, Strada

ALTERNATOR / ALTERNATOR:

BOSCH: 0 124 215 001, 0 124 215 002, 0 124 215 003, 0 124 215 007, 0 124 225 010, 0 124 225 049, 0 124 225 050, 0 124 315 001, 0 124 315 002, 0 124 315 003, 0 124 315 004, 0 124 315 005, 0 124 315 006, 0 124 315 007, 0 124 315 008, 0 124 315 010, 0 124 315 011, 0 124 315 013, 0 124 315 014, 0 124 315 016, 0 124 315 024, 0 124 315 025, 0 124 315 029, 0 124 315 031, 0 124 315 032, 0 124 315 033, 0 124 315 034, 0 124 315 036, 0 124 315 037, 0 124 320 001, 0 124 325 001, 0 124 325 002, 0 124 325 003, 0 124 325 004, 0 124 325 006, 0 124 325 007, 0 124 325 011, 0 124 325 012, 0 124 325 013, 0 124 325 014, 0 124 325 015, 0 124 325 016, 0 124 325 017, 0 124 325 018, 0 124 325 020, 0 124 325 024, 0 124 325 028, 0 124 325 032, 0 124 325 033, 0 124 325 036, 0 124 325 039, 0 124 325 040, 0 124 325 043, 0 124 325 045, 0 124 325 046, 0 124 325 048, 0 124 325 049, 0 124 325 055, 0 124 325 073, 0 124 325 074, 0 124 325 075, 0 124 325 077, 0 124 325 079, 0 124 325 087, 0 124 325 088, 0 124 325 093, 0 124 325 101, 0 124 325 105, 0 124 325 137, 0 124 325 140, 0 124 325 111, 0 124 325 141, 0 124 325 165, 0 124 325 170, 0 124 325 177

VOLTAGE REGULATOR:

GA220 / GA225 / GA239 / GA240 / GA261 / GA265 / GA281 / GA282 / GA391

BOSCH
GA1426

FEATURES / CARACTERÍSTICAS: 120A, Diodos Avalanche (Zener) 6x50A

REPLACES / REEMPLAZA:

Bosch: F 00M 123 211, F 00M 123 331; **Cargo:** 235053; **WAI/Transpo:** IBR2304; **Magneti Marelli:** PR520468

APPLICATION / APLICACIÓN:

FIAT: Brava, Marea, Stilo, Strada 1.6 16V

ALTERNATOR / ALTERNATOR:

BOSCH: 0 124 415 011, 0 124 415 012, 0 124 415 037

VOLTAGE REGULATOR:

GA220 / GA281 / GA391

BOSCH
GA1427

FEATURES / CARACTERÍSTICAS: 120A, Diodos Avalanche (Zener) 6x50A

REPLACES / REEMPLAZA:

Bosch: F 00M 133 211; **Cargo:** 331001; **WAI/Transpo:** IBR211

APPLICATION / APLICACIÓN:

GM: Astra, Safira, Vectra

ALTERNATOR / ALTERNATOR:

BOSCH: 0 124 515 043, 0 124 515 081, 0 124 525 015

VOLTAGE REGULATOR:

GA281

BOSCH
GA1428

FEATURES / CARACTERÍSTICAS: 120A, Diodes 6x50A Avalanche (Zener), B+ Post M8

REPLACES / REEMPLAZA:

Bosch: F 00M 123 328; **Magneti Marelli:** PR520564

APPLICATION / APLICACIÓN:

VW: Light Trucks

ALTERNATOR / ALTERNATOR:

BOSCH: 0 124 325 067

VOLTAGE REGULATOR:

GA261

BOSCH
GA1430

FEATURES / CARACTERÍSTICAS: 120A, Diodes 6x50A Avalanche (Zener), B+ Post M6

REPLACES / REEMPLAZA:

Bosch: F 00M 123 252, F 00M 123 309; **Magneti Marelli:** PR520562

APPLICATION / APLICACIÓN:

FORD: F250 Cummins, MWM, F350 Cummins, F4000 Cummins, F12000, 14000, 16000 98>

ALTERNATOR / ALTERNATOR:

BOSCH: 0 124 325 064, 0 124 325 063, 0 124 325 161

VOLTAGE REGULATOR:

GA234 / GA235

BOSCH
GA1431

FEATURES / CARACTERÍSTICAS: 105A, 6x35A

REPLACES / REEMPLAZA:

Bosch: F 00M 123 310

APPLICATION / APLICACIÓN:

FORD: F12000, F14000, F16000, MTR, 6BTAA, 6CTAA, 4BTAA

ALTERNATOR / ALTERNATOR:

BOSCH: 0124325124, 0124325115, 0124325109

VOLTAGE REGULATOR:

GA231

BOSCH
GA1432

FEATURES / CARACTERÍSTICAS: 150A, 6x50A

REPLACES / REEMPLAZA:

Bosch: F 00M 123 214

APPLICATION / APLICACIÓN:

MERCEDES: MB170, 712E, L0812, L1114, L1214

ALTERNATOR / ALTERNATOR:

BOSCH: 0 124 325 098

VOLTAGE REGULATOR:

GA261

BOSCH
GA1433

FEATURES / CARACTERÍSTICAS: 85A, Diodes 6x35A Avalanche (Zener), B+ Post M8

REPLACES / REEMPLAZA:

Bosch: F 00M 133 223, F 00M 133 291, F 00M 133 346; **Cargo:** 231524; **WAI/Transpo:** IBR223; **Magneti Marelli:** PR520563

APPLICATION / APLICACIÓN:

VOLVO: FH 01-06, NH 12, B12 B 01>, B10 M, B12M <06, FM12 02-05;

RENAULT: Magnum 440 / 480 04-06;

FORD: Cargo C, 2632/ 2932/ 4432 /4532 /5032 /6332;

MAN: 06>

ALTERNATOR / ALTERNATOR:

BOSCH: 0 124 555 005, 0 124 555 017, 0 124 555 020, 0 124 555 027, 0 124 555 028, 0 124 555 029, 0 124 555 030, 0 124 555 056, 0 124 555 053, 0 124 655 066, 0 124 655 008, 0 124 655 009, 0 124 655 011, 0 124 655 012, 0 124 655 013, 0 124 655 019, 0 124 655 030, 0 124 655 036, 0 124 655 037, 0 124 655 039

VOLTAGE REGULATOR:

GA297 / GA300

BOSCH
GA1434

FEATURES / CARACTERÍSTICAS: 200A, 6x80A Avalanche Diodes

REPLACES / REEMPLAZA:

Bosch: F 00M 133 282

APPLICATION / APLICACIÓN:

John Deere: 9570, 9670, 9770, 9870 (2007-2009)

ALTERNATOR / ALTERNATOR:

Bosch: 0 124 625 030

BOSCH
GA1436

FEATURES / CARACTERÍSTICAS: 120A, Diodes 6x50A Avalanche (Zener), B+ Post M8
REPLACES / REEMPLAZA:
Bosch: F 00M 133 360; **Cargo:** 331001; **WAI/Transpo:** IBR211; **Magneti Marelli:** PR520569
APPLICATION / APLICACIÓN:
GM: Astra 1.8, 2.0, 2.0 16V 05>, Corsa 1.0, 1.0 16V, 1.6, 1.6 16V 00>, Vectra A 2.0 16V 00>, Celta 1.0 08>
ALTERNATOR / ALTERNATOR:
BOSCH: 0 124 515 082, 0 124 515 089
VOLTAGE REGULATOR:
 GA281

BOSCH
GA1437

FEATURES / CARACTERÍSTICAS: 14V, 6x50A Press-fit Avalanche Diodes
REPLACES / REEMPLAZA:
Bosch: F 00M 133 267; **Mobiletron:** RB-174HD
APPLICATION / APLICACIÓN:
BMW: Serie 1 - 116i, 118i, 120i, Serie 1 Coupe - 120i, Serie 1 Convertible - 118i, 120i, Serie 3 Convertible - 318Ci, Serie 3 Saloon 316i, 318i, 320i, 320si, Serie 3 Estate - 318i, 320i, Serie 3 Coupe - 320i, Serie 3 Convertible - 320i, Serie 5 Saloon - 520i; Serie X1 - sDrive 18i; Serie X3 - 2.0i, xDrive 20i; Serie Z4 Roadster - 2.0i
ALTERNATOR / ALTERNATOR:
BOSCH: 0 124 525 059, 0 124 525 045, 0 124 525 561, 0 124 525 524
VOLTAGE REGULATOR:
 GA266

BOSCH
GA1438

FEATURES / CARACTERÍSTICAS: 120A, Diodes 6x50A Avalanche (Zener), B+ Post M8
REPLACES / REEMPLAZA:
Bosch: F 00M 123 238, F 00M 123 323, F 00M 123 218, F 00M 123 308; **Cargo:** 235694; **WAI/Transpo:** IBR238
APPLICATION / APLICACIÓN:
TOYOTA: Avenis00-03, Corolla, Fielder 99-08, Hilux, SW4 05>
ALTERNATOR / ALTERNATOR:
BOSCH: 0 124 315 015, 0 124 315 016, 0 124 315 024, 0 124 315 025, 0 124 315 029, 0 124 315 034, 0 124 315 036, 0 124 325 165, 0 124 315 040
VOLTAGE REGULATOR:
 GA265

BOSCH
GA1439



FEATURES / CARACTERÍSTICAS: 90A, 6x35A Avalanche diodes
REPLACES / REEMPLAZA:
Bosch: F 00M 123 224
APPLICATION / APLICACIÓN:
VW: 13.180 Mot 6.10 TCA
ALTERNADOR:
BOSCH: 0 124 325 118

BOSCH
GA1440

FEATURES / CARACTERÍSTICAS: 90A, 6x35A Avalanche diodes
REPLACES / REEMPLAZA:
Bosch: F 00M 123 267, F 00M 123 296
APPLICATION / APLICACIÓN:
FORD: Cargo C 815 E Eletronic Interact 4 150, Cargo C 1317 E Eletronic Interact 4 170, Cargo C 1517 E Eletronic Interact 4 170, Cargo C 1717 E Eletronic Interact 4 170, Cargo C 1722 E Eletronic Interact 6, Cargo C 2422 E Eletronic Interact 6, Cargo C 2428 E Eletronic Interact 6, Cargo C 2622 E Eletronic Interact 6, Cargo C 2628 E Eletronic Interact 6, 1722 - 422, Cummins Interact 6, 5.9 ltrs, F 250 3.9 mot. Cummins Max Power
ALTERNATOR / ALTERNATOR:
BOSCH: 0 124 325 136, 0 124 325 211

BOSCH
GA1442

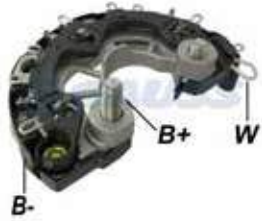
FEATURES / CARACTERÍSTICAS: 150A, 6x50A Avalanche diodes, M8x20mm, Diameter: 133mm
REPLACES / REEMPLAZA:
Bosch: F 00M 133 401
APPLICATION / APLICACIÓN:
FIAT: Iveco Daily, Ducato Cargo 2.3 04>12, Ducato Combinato 2.3 04>12, Ducato Maxi Cargo 2.3 04>12, Ducato Minibus 2.3 04>12, Ducato Multi 2.3 04>12;
IVECO: CityClass 08>11, Scudato 60.13 10>11
ALTERNATOR / ALTERNATOR:
BOSCH: 0 124 525 196
VOLTAGE REGULATOR:
 GA343

BOSCH
GA1446

FEATURES / CARACTERÍSTICAS: 85A, Diodes 6x35A Avalanche (Zener), B+ Post M8

REPLACES / REEMPLAZA:
Bosch: F 00M 113 246, F 00M 113 251; **Regitar:** RB-115H; **Cargo:** 230360; **WAI/Transpo:** IBR202

APPLICATION / APLICACIÓN:
GM: Corsa, Pick up, Sedan, Wagon 1.0, 1.6 06>, S10, Astra 01>, Celta 08-00, Vectra 2.0 96-97, 2.2 00>, Zafira 2.0 01>

ALTERNATOR / ALTERNATOR:
BOSCH: 0 124 225 029

VOLTAGE REGULATOR:

GA281

BOSCH
GA1447

FEATURES / CARACTERÍSTICAS: 140A, 6x50A, B+: M8x14/ M8x19mm, Avalanche Diode, Diameter: 130mm

REPLACES / REEMPLAZA:
Bosch: F 00M 133 259

APPLICATION / APLICACIÓN:
AUDI: A3 MK 2 HATCH 3-Door/5-Door 1.8 TFSI 06>13/ 1.8 TFSI Quattro 08>13/ 2.0 TFSI 04>13/ 1.8 TFSI Quattro 04>13, A4 MK 2 Saloon/ Avant/ Estate 1.6 00>04/ 1.8 T 00>04/ 1.8 T Quattro 00>04/ 2.0 00>04/ 2.0 FSI 02>04, A4 Convertible 1.8 T 02>09/ 1.8 T Quattro 03>09/ 2.0 04>05/ 2.0 TFSI 16V 06>09/ A4 MK 3 Saloon/ Avant/ Estate 1.6 04>08/ 1.8 T 04>08/ 1.8 T Quattro 04>08/ 2.0 04>08/ 2.0 TFSI 04>08/ 2.0 TFSI Quattro 04>08, A6 MK 2 Saloon/ Avant/ Estate 2.0 01>05, TT Coupe MK 2/ TT Roadster Cabrio MK 2 1.8 TFSI 08>14/ 2.0 TFSI 06>10/ 2.0 TFSI Quattro 08>10;

SEAT: Alhambra 1.8 TSI 12>/ 2.0 TSI 10>, Altea MPV 1.8 TFSI 07>, Altea XL MPV 1.8 TFSI 07>/ 2.0 TFSI 4x4 09>, Exeo/ Exeo ST 1.6 09>10/ 1.8 T 08>10/ 2.0 TFSI 09>, Leon MK 2 Hatch 1.8 TSI 07>12/ 2.0 TFSI 09>12, Toledo MK 3 MPV 1.8 TFSI 07>09;

SKODA: Octavia MK 2 Hatch 1.8 TSI 07>13/ 2.0 RS 05>13, Octavia MK 2 Estate 1.8 TSI 07>13/ 1.8 TSI 4x4 08>13/ 2.0 RS 05>13, Superb MK 2/ Estate 1.8 TSI 08>15/ 1.8 TSI 4x4 08>15/ 2.0 TSI 10>15, Yeti 1.8 TSI 4x4 09>;

VW: Beetle/ Convertible 2.0 TSI 11>, EOS Convertible 2.0 TFSI 06>15/ 2.0 TSI 09>15, GOLF VI 1.8 TSI 09>11/ 2.0 GTI 09>12, Golf VI Variant 2.0 TSI 09>13, Golf VI Convertible 2.0 GTI 11>, Jetta MK 3 Saloon 2.0 TFSI 05>10, Jetta IV 2.0 TSI 10>, Passat MK 6 Saloon/Estate 1.8 TSI 07>11 / 2.0 FSI 05>10, Passat Alltrack 1.8 TSI 12>14, Passat CC Saloon 1.8 TSI 08>12/ 2.0 TSI 08>12, CC 1.8/ 2.0 TSI 11>, Passat/ Passat Variant 1.8 TSI 10>14, Scirocco MK 3 Coupe 2.0 TSI 08>, Sharan 2.0 TSI 10>, Tiguan TFSI 4Motion 07>, Tiguan TSI 4Motion 11>

ALTERNATOR / ALTERNATOR:
BOSCH: 0 124 525 088; **VW:** 06B 903 016 AB

VOLTAGE REGULATOR:

GA222

BOSCH
GA1448

FEATURES / CARACTERÍSTICAS: 150A, 6x50A Avalanche Diode, B+: M8x20mm M8x25mm, Diameter: 130mm

REPLACES / REEMPLAZA:
Bosch: F 00M 147 623

APPLICATION / APLICACIÓN:
VOLVO: 9700/9900 09>

ALTERNATOR / ALTERNATOR:
BOSCH: 0124655052, 0124655057, 0124655075

VOLTAGE REGULATOR:

GA297

BOSCH
GA1466

FEATURES / CARACTERÍSTICAS: 105A, 6x50A, B+: M8X21.2mm / M8X7.1mm, External Diameter: 120mm

REPLACES / REEMPLAZA:
Bosch: F 00M 123 318; **Transpo:** IBR2237, IBR202; **Cargo:** 231592; **As-Poland:** ARC0066; **Mobiletron:** RB-115H; **Regitar:** RB-115H

APPLICATION / APLICACIÓN:
ALFA ROMEO: 159 1.8 MPI 2008>2010

FIAT: Croma 1.8 16V 2005

OPEL: Astra G Box 1.6 2004>2005, Astra H 1600 16V 2007>2009, Zafira B 1600 16V 2006>2010, Zafira B 1800 16V 2005>2010, Astra van H 1600 2007>2009

RENAULT: Espace III 2000 16V 1999>2002, Laguna 1600 16V 1998>2005, Laguna 1800 16V 1998>2001, Laguna 2000 16V 1999>2001, Megane 1400/1600 16V 1999>2002, Megane 1800/2000 16V 2000>2002, Megane Classic 1400/1600/1800/2000 16V 1999>2002, Megane Scenic 1400/1600/1800/2000 16V 1999>2002

SAAB: 9-3 L4 2.0 2003>2011, 9-3X L4 2.0 2010>2011

VAUXHALL: Corsa D 2009>2018, Meriva B 2010>2018

ALTERNATOR / ALTERNATOR:
ALFA ROMEO: 51754152, 60694260;

FIAT: 46843097, 468430970, 51734824, 51754153, 60694260, 73503235

CHEVROLET: 13229987, 13308508, 6204123, 93188158, 93190829

HOLDEN: 93-177-834

OPEL: 93183436, 09119309, 1202199, 1204054, 1204137, 12762730

RENAULT: 6001548061, 7700101274, 7700421477, 7700421477, 7700429217, 7700429310

SAAB: 12-75-5484, 12-75-7363, 12762730, 93-17-6035, 93-19-0828, 93-190-829, 93191922, 93191922

VAUXHALL: 13266810, 93189237, 93190894

BOSCH
GA1467

FEATURES / CARACTERÍSTICAS: 200A, 6x80A, Avalanche Diode B+: M8x7.9mm / M8x20.2mm, External Diameter: 130mm

REPLACES / REEMPLAZA:

Bosch: F 00M 133 276; **Transpo:** IBR216; **Cargo:** 236821; **AS-Poland:** ARC0151; **Mobiletron:** RB-166H; **Regitar:** RB-166H

APPLICATION / APLICACIÓN:

VOLVO: XC90 L6 2.9 2003>2005, S60 I T5 2.0 2000>2004, S80 2900 2002>2004, V70 II T5 2.0 T 2001>2004

MERCEDES-BENZ: Vaneo 2100 2004>2010, Sprinter 209/ 211/ 213/ 215/ 309/ 311/ 313/ 315/ 415 2006>2010, Vito 109D/ 111D/ 115D 2003>2010

VOLKSWAGEN VAN: Transporter L4 2.0 2010>2014

ALTERNATOR / ALTERNATOR:

BOSCH: 0 124 625 001, 0 124 625 006, 0 124 625 007, 0 124 625 010, 0 124 625 020, 0 124 625 022, 0 124 625 024, 0 124 625 025, 0 124 625 026, 0 124 625 028, 0 124 625 032

VOLKSWAGEN: 021903026G, 021903026GX, 022903028B, 022903028BX, 059903015Q

MERCEDES-BENZ: 0121548902, 0131541002, 0131541102, 0131542102, 0131548502, 0131548902

VOLVO: 30658086, 30667893, 8602713, 86027130, 86027133, 8603264, 86032650, 8637849

BOSCH
GA1468

FEATURES / CARACTERÍSTICAS: 200A, 6x80A, B+: M8x10.2mm / M8x7.4mm, External diameter: 130mm

REPLACES / REEMPLAZA:

Bosch: F 00M 133 331; **Transpo:** IBR240; **Cargo:** 331002; **AS-Poland:** ARC0064

APPLICATION / APLICACIÓN:

MERCEDES-BENZ: E220D 2200 2002>2010, E270D 2700 2002>2005

ALTERNATOR / ALTERNATOR:

BOSCH: 0 124 625 002

MERCEDES-BENZ: 0121545902, 012159802, 0131540002, 0131545902, A0131545902, A0121545902, A0121549802, A0131540002, A0141540702

BOSCH
GA1469

FEATURES / CARACTERÍSTICAS: 87A, 6x50A, Diodo Avalanche B+: M8x20.5mm, External Diameter: 120mm

REPLACES / REEMPLAZA:

Bosch: F 00M 123 313; **Cargo:** 235567; **Transpo:** IBR230

APPLICATION / APLICACIÓN:

RENAULT: Clio II 1400 8v 1998>2000, Kangoo 1400 8v 1998>2000, Megane 1400/1600 16v 1999>2002, Megane Classic 1400/1600 16v 1999>2002, Megane Scenic 1400/1600 16v 1999>2002

TOYOTA: Avensis Mk1 hatch/saloon/estate 1.6/1.8 2000>2003, Avensis Mk2 hatch/saloon/estate 1.6/1.8 2003>2008, Corolla hatch 1.4/1.6 2000>2002, Corolla estate 1.4/1.6 2002>2007

ALTERNATOR / ALTERNATOR:

RENAULT: 7700427932, 7700434899, 7701473637, 7701713149, 8200692863, 8200692866

TOYOTA: 27060-165FL

BOSCH
GA1470

FEATURES / CARACTERÍSTICAS: 150A, 6x60A, Avalanche Diode B+: M8x23.5mm, External Diameter: 130mm

REPLACES / REEMPLAZA:

Bosch: F 00M 133 289, F 00M 133 243; **Transpo:** IBR243; **Cargo:** 237356; **As-Poland:** ARC0183

APPLICATION / APLICACIÓN:

NISSAN: Primastar Box 2.0 2003>2006, Primastar 2000 2003>2010

RENAULT: Laguna 2000 16v turbo 2002>2007, Laguna 2200 2003>2007, Vel Satis 2000/2200 16v turbo 2002>2010, Traffic 2000 2006>2010

ALTERNATOR / ALTERNATOR:

NISSAN/INFINITI: 23100-00Q0H, 23100-00Q2E, 23100-00QBB, 23100-BN701

RENAULT: 7701474326, 7711135519, 7711135812, 7711135942, 7711497098, 82 00 327 183

BOSCH: 0 124 525 028, 0 124 525 043, 0 124 525 044, 0 124 525 047, 0 124 525 049, 0 124 525 053, 0 124 525 069, 0 124 525 070, 0 124 525 076, 0 124 525 081, 0 124 525 082, 0 124 525 084, 0 124 525 096, 0 124 525 108, 0 124 525 132, 0 124 525 135, 0 124 525 137, 0 124 525 141, 0 124 525 151, 0 124 525 528, 0 124 525 532, 0 124 525 533, 0 124 525 534, 0 124 525 535, 0 124 525 536, 0 124 525 537, 0 124 525 538, 0 124 525 541

BOSCH
GA1473 // NEW //

FEATURES / CARACTERÍSTICAS: 150A, 6x60A Avalanche Diode, B +: M8x1.25x38mm. Outside diameter 130mm

REPLACES / REEMPLAZA:

Bosch: F 00M 133 372, F 00M 133 226, F 00M 133 258, F 00M 133 281; **Transpo:** IBR226

APPLICATION / APLICACIÓN:

BMW: 320i 2001>2005, 325Ci 2001>2006, 325xi L6 2.5 2001>2005, 330Ci 2001>2006, 330xi 2001>2006, 525i 2001>2003, 530i 2001>2003, Z3 2001>2002

ALTERNATOR / ALTERNATOR:

...

BOSCH

GA1480 // NEW //
FEATURES / CARACTERÍSTICAS: 160A, 6x60A Avalanche Diode, B+: M6x1.0x31.3mm

REPLACES / REEMPLAZA:
Bosch: F 00M 133 279; **Transpo:** IBR279

APPLICATION / APLICACIÓN:
CASE - Tractors Case MX220 MX220 MX230 MX240 MX270 Cummins New Holland

ALTERNATOR / ALTERNATOR:

...

BOSCH

GA1488 // NEW //
FEATURES / CARACTERÍSTICAS: 120A, 6x50A Avalanche Diode, B+: M8x1.25x30.7mm

REPLACES / REEMPLAZA:
AS-Poland: ARC0191

APPLICATION / APLICACIÓN:
CATERPILLAR: Excavator 320B, Excavator 320D, Excavator 323DI, Excavator 924K, Excavator 930, Excavator 938, Excavator 950K, Excavator 966H

ALTERNATOR / ALTERNATOR:
BOSCH: 0 124 655 297, 0 124 655 120, 0 124 655 076

CATERPILLAR: 344 5081

VOLTAGE REGULATOR:

GA308

BOSCH

GA1490
FEATURES / CARACTERÍSTICAS: 120A, Diodos 6x50A Avalanche (Zener), B+ Post M8

REPLACES / REEMPLAZA:
Bosch: F 00M 133 290; **Cargo:** 333527; **WAI/Transpo:** IBR257; **Magneti Marelli:** PR520567

APPLICATION / APLICACIÓN:
MERCEDES BENZ: 1318, 1618M, 1728, 2423, 2428, 712C, 914C, LO, 915, L1620, LO915, Atego 1315, 1318, 1518, 1718, 2425, 2428, Axor 1933, 2533, 2826, 2831, Acelo 915C

ALTERNATOR / ALTERNATOR:
BOSCH: 0 124 555 032, 0 124 555 044, 0 124 555 045, 0 124 555 046, 0 124 655 023, 0 124 655 069

VOLTAGE REGULATOR:

GA298

BOSCH

GA1411 // NEW //
FEATURES / CARACTERÍSTICAS: 150A, Avalanche Diode 6x60A, B+: M8x12mm, External diameter 130mm

REPLACES / REEMPLAZA:
Transpo: IBR40011; **AS-Poland:** ARC0057

APPLICATION / APLICACIÓN:
BMW: Mini One 1400 16V 2007>2010, Mini One 1600 16V 2006>2010

MINI: Cooper L4 1.6L 1598cc 2007>2010

CITROËN: Berlingo 1.6 VTi 2009>2010, C4 Grand Picasso 1.6 2008>2013, C5 III 1.6 THP 2009>2010, DS3 Convertible 1.6 THP 2013>2015, DS4 1.6 VTi 2011>2015, DS5 1.5 THP 2011>2015

PEUGEOT: 207 1600 16V 2006>2010, 308 1400/1600 16V 2007>2012

ALTERNATOR / ALTERNATOR:
BOSCH: 0 121 615 027, 0 121 615 127, F 00M 314 001, F 00M 314 004, F 00M 314 029, F 00M 349 922

BMW: 12317575650, 12317575872, 12317575873, 12317576550

CITROËN/ PEUGEOT: 5702L3, 5705KF

BOSCH

GA1435
FEATURES / CARACTERÍSTICAS: 180A, 6x70A Avalanche Diode

REPLACES / REEMPLAZA:
Bosch: F 00M 314 001, F 00M 314 029

APPLICATION / APLICACIÓN:
LAND ROVER: LR2 L6 3.2L 3192cc 2008-2010; Freelander II 3200, SI6 2006-2010

VOLVO: S60 L5 2.5L 2521cc 2012; S60 L6 3.0L 2953cc 2011-2013; S60 L6 3.0L 2953cc 180cid 2011-2013; S80 L6 3.0L 2953cc 2008-2013; S80 L6 3.0L 2953cc 180cid 2010-2011; S80 L6 3.2L 3192cc 2007-2010; V70 L6 3.2L 3192cc 2008-2010; XC70 L6 3.0L 2953cc 2009-2010; XC70 L6 3.2L 3192cc 2008-2010; XC60 L6 3.0L 2953cc 2010; XC60 L6 3.0L 2953cc 180cid 2010; XC60 L6 3.2L 3192cc 2010; XC60 L6 3.2L 3192cc 195cid 2010; XC90 L6 3.2L 3192cc 2007-2013; XC90 L6 3.2L 3192cc 195cid 2010; S80 Mk2 3200, B6324S 2006-2010; V70 Mk3 3000, B6304T2 2007-2012; V70 Mk3 3200, B6324S 2007-2012; XC70 Mk2 3200, B6324S 2007-2012; XC90 3200, B6324S 2006-2010

ALTERNATOR / ALTERNATOR:

0.121.715.009

BOSCH
GA1441

FEATURES / CARACTERÍSTICAS: 150A, 6x50A Avalanche Diode (high efficiency), B+: M8x18mm, Diameter: 127mm
REPLACES / REEMPLAZA:

...

APPLICATION / APLICACIÓN:

MERCEDES: C-KLASSE Kombi, Coupe, C 180, C220C C230, C300, C630, E-KLASSE Cabriolet, E 200

ALTERNATOR / ALTERNATOR:

Mercedes: A 000 906 20 03 Q1, A 000 906 20 03 0080, A 000 906 20 03 80, 000 906 20 03, 000 906 20 03 0080, 000 906 20 03 80;
Bosch: 0 125 711 032, 0 986 081 730

VOLTAGE REGULATOR:

GA345

BOSCH
GA1443

FEATURES / CARACTERÍSTICAS: 150A, 6x50A Avalanche Diode (high efficiency), B+: M8x18mm, Diameter 127mm
REPLACES / REEMPLAZA:

...

APPLICATION / APLICACIÓN:

MERCEDES: B200, Sprinter, GLA180M 1.6L, GLA200M 1.6L, GLA250M 2.0L

AUDI: Q5 1.8, 2.0 TFSI

ALTERNATOR / ALTERNATOR:

Mercedes: A 000 906 00 22, A 000 906 19 03, A 000 906 19 03 0080;

Bosch: 0 125 711 030, 0 986 082 160

VOLTAGE REGULATOR:

GA345

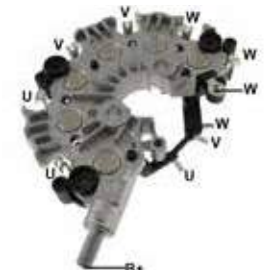
BOSCH
GA1444

FEATURES / CARACTERÍSTICAS: 75A, 6x35A Avalanche Diode, B+: M8x16mm, with diode trio

REPLACES / REEMPLAZA:

Bosch: F 00M 324 060

APPLICATION / APLICACIÓN:

BMW: 128i L6 3.0L 2996cc 2008-2013, 323i L6 2.5L 2497cc 2007-2009, 328i L6 3.0L 2996cc 2007-2013, 328i xDrive L6 3.0L 2996cc 2009-2013, 328xi L6 3.0L 2996cc 2007-2008, 330i L6 3.0L 2996cc N52 2006, 330xi L6 3.0L 2996cc N52 2006

ALTERNATOR / ALTERNATOR:

Bosch: 0 121 715 012; **BMW:** 12317550968, 12317551254, 12317551256, 12317555926, 57550968-05, 7551256-05

VOLTAGE REGULATOR:

GA348

BOSCH
GA1445

FEATURES / CARACTERÍSTICAS: 150A, 6X50A Avalanche Diode, B+: M8X11mm, Diameter: 127mm

REPLACES / REEMPLAZA:

Bosch: F 00M 573 933, F 00M 599 415; **Transpo:** IBR415

APPLICATION / APLICACIÓN:

BMW: Mini One 1400, 16V, N12B14A 2010>2012, Mini One 1600, 16V, N12B16 2010>2012, Cooper L4 1.6L 1598cc 2011>2016, Cooper L4 1.6L 1598cc 98cid 2011>2014, Cooper Countryman L4 1.6L 1598cc 2011>2016, Cooper Countryman L4 1.6L 1598cc 98cid 2011>2014, Cooper Paceman L4 1.6L 1598cc 2013>2016, Countryman L4 1.6L 1598cc 98cid 2011>2013

ALTERNATOR / ALTERNATOR:

BOSCH: 0 125 711 011, 0 125 711 078; **BMW:** 12-31-7-604-782, 12-31-7-613-445

VOLTAGE REGULATOR:

GA349

BOSCH
GA1481 // NEW //

FEATURES / CARACTERÍSTICAS: 150A, 6X60A Avalanche Diode, B+: M8x1.25x23.6mm

REPLACES / REEMPLAZA:

Bosch: F 00M 599 451; **AS-Poland:** ARC0203; **Mobiletron:** RB-195H; **Transpo:** IBR4051

APPLICATION / APLICACIÓN:

FORD: Ranger TDCi 4x4 2.2 4cc Diesel 2011>, Ranger TDCi 4x4 3.2 5cc Diesel 2011>, Transit MK 7 Minibus 2.2 4cc Diesel 2011>2014, Transit MK 7 Van 2.2 4cc Diesel 2011>2014, Transit MK 7 Flatbed 2.2 4cc Diesel 2011>2014, Transit V363 Bus 2.2 4cc Diesel 2013>, Transit V363 Box 2.2 4cc Diesel 2013>, Transit V363 Platform 2.2 4cc Diesel 2013>

ALTERNATOR / ALTERNATOR:

BOSCH: 0 125 711 046, 0 125 711 103, 0 125 711 133, 0 986 082 330

BOSCH
GA1491

FEATURES / CARACTERÍSTICAS: 105A, 3x35A Avalanche Diodes

REPLACES / REEMPLAZA:

-

APPLICATION / APLICACIÓN:

Renault: Clio, Sandero, Logan, Kangoo, Duster, Dokker, Lodgy, Tondar (1.6).

ALTERNATOR / ALTERNATOR:

Bosch: F 000 BL0 408, F 000 BL0 4F0;

Renault: 23 10 076 33R

BOSCH

GA1492

FEATURES / CARACTERÍSTICAS: 6x50A, Avalanche

REPLACES / REEMPLAZA:

-

APPLICATION / APLICACIÓN:

FIAT: Uno Evolution 1.4 Fire Flex 8V 5p 2015>

ALTERNATOR / ALTERNATOR:

Bosch: F 000 BL0 7E4

VOLTAGE REGULATOR:

GA343

BOSCH

GA1493

FEATURES / CARACTERÍSTICAS: 150A | 6x50A, High efficient avalanche Diode, B+: M8x15mm

REPLACES / REEMPLAZA:

-

APPLICATION / APLICACIÓN:

JEEP: Renegade;

FIAT: Toro

ALTERNATOR / ALTERNATOR:

Bosch: F 000 BL0 7P3

VOLTAGE REGULATOR:

GA338

BOSCH

GA1494

FEATURES / CARACTERÍSTICAS: 90A, 6x35A, Avalanche Diode, B+: M8x17mm

REPLACES / REEMPLAZA:

-

APPLICATION / APLICACIÓN:

NISSAN: Kicks 1.6 XTRONIC CVT 2017

ALTERNATOR / ALTERNATOR:

BOSCH: F 000 BL0 4M0

NISSAN: 23100 5RA0A

VOLTAGE REGULATOR:

GA351

BOSCH

GA1495

FEATURES / CARACTERÍSTICAS: 140A, 6x50A Avalanche Diode, B+: M8X13mm

REPLACES / REEMPLAZA:

Bosch: F 000 BL2 114

APPLICATION / APLICACIÓN:

AUDI: A1 1.8 TFSI 2015>, A1 Sportback TFSI 2015>, A3/Sportback/Limousine/Convertible 1.8 TFSI / 1.8 TFSI quattro / S3 quattro 2012>, Q3 2.0 TFSI quattro 2014>, TT / TT Roadster 2.0 TFSI / 2.0 TFSI quattro 2014>;

SEAT: Leon/Leon SC 1.8 TSI / 2.0 Cupra 2013>;

SKODA: Octavia III 1.8 TSI / 2.0 TSI RS 2012>;

VOLKSWAGEN: Golf 2.0 GTI 2013>

ALTERNATOR / ALTERNATOR:

BOSCH: F 000 BL0 803;

VW: 06J 903 023G

VOLTAGE REGULATOR:

GA364

BOSCH
GA1498 // NEW //
FEATURES / CARACTERÍSTICAS: 90A, 6x50A Avalanche Diode, B+: M8x1.25x12.6mm

REPLACES / REEMPLAZA:
Bosch: 1 127 319 694; **Transpo:** IBR694; **Mobiletron:** RB-36H

APPLICATION / APLICACIÓN:

CITROËN: BERLINGO (MF) Eng.D9B (XUD9A/L), DJY (XUD9A) 1.9 D (MFDJY) 50kw ""D9B (XUD9A/L), DJY (XUD9A)"" 1996-2003, BERLINGO (MF) Eng.D9B (XUD9A/L), DJY (XUD9A) 1.9 D (MFDJY) 50kw D9B (XUD9A/L), DJY (XUD9A) 1996, BERLINGO Box (M_) Eng. A9A (XUD7) 1.8 D (MBA9A, MCA9A) 43kw A9A (XUD7) 1996-2001, BERLINGO Box (M_) Eng.DJY (XUD9A) 1.9 D (MBDJY) 51kw DJY (XUD9A) 1996-2003, EVASION (22, U6) Eng.D8B (XUD9TF) 1.9 TD 68kw D8B (XUD9TF) 1995-1998, EVASION (22, U6) Eng.D8B (XUD9TF), DHX (XUD9TF/BTF) 1.9 TD 66kw ""D8B (XUD9TF), DHX (XUD9TF/BTF)"" 1999-2000, EVASION (22, U6) Eng.D8B (XUD9TF), DHX (XUD9TF/BTF) 1.9 TD 66kw D8B (XUD9TF), DHX (XUD9TF/BTF) 1999-2000, JUMPY Box (BS_, BT_, BY_, BZ_) Eng.D9B (XUD9A/U) 1.9 D 51kw D9B (XUD9A/U) 1996-1998, JUMPY Box (BS_, BT_, BY_, BZ_) Eng.DHX (XUD9TF/BTF) 1.9 TD 66kw DHX (XUD9TF/BTF) 1996-2000, XANTIA (X1) Eng.P8C (XUD11BTE) 2.1 Turbo D 12V 80kw P8C (XUD11BTE) 1997-1998, XANTIA (X2) Eng.DHX (XUD9TF/BTF), DHY (XUD9TE/Y) 1.9 Turbo D 66kw ""DHX (XUD9TF/BTF), DHY (XUD9TE/Y)"" 1999-2000, XANTIA (X2) Eng.DHX (XUD9TF/BTF), DHY (XUD9TE/Y) 1.9 Turbo D 66kw DHX (XUD9TF/BTF); DHY (XUD9TE/Y) 1999-2000, XANTIA (X2) Eng.P8C (XUD11BTE) 2.1 Turbo D 12V 80kw P8C (XUD11BTE) 1998-1999, XANTIA Break (X1) Eng.P8C (XUD11BTE) 2.1 Turbo D 12V 80kw P8C (XUD11BTE) 1997-1998, XANTIA Break (X2) Eng.D8B (XUD9TF), DHX (XUD9TF/BTF) 1.9 Turbo D 66kw ""D8B (XUD9TF), DHX (XUD9TF/BTF)"" 1999-2000, XANTIA Break (X2) Eng.D8B (XUD9TF), DHX (XUD9TF/BTF) 1.9 Turbo D 66kw D8B (XUD9TF); DHX (XUD9TF/BTF) 1999-2000, XANTIA Break (X2) Eng.P8C (XUD11BTE) 2.1 Turbo D 12V 80kw P8C (XUD11BTE) 1998-1999, XSARA (N1) Eng.DHY (XUD9TE/Y) 1.9 TD 66kw DHY (XUD9TE/Y) 1997-1999, XSARA (N1) Eng. DJY (XUD9A) 1.9 D 50kw DJY (XUD9A) 1997-1999, XSARA Break (N2) Eng.DHY (XUD9TE/Y) 1.9 TD 66kw DHY (XUD9TE/Y) 1998-1999, XSARA Break (N2) Eng.DJY (XUD9A) 1.9 D 50kw DJY (XUD9A) 1998-1999, ZX (N2) Eng.D9B (XUD9A/U), DJY (XUD9A) 1.9 D 50kw ""D9B (XUD9A/U), DJY (XUD9A)"" 1995-1997, ZX (N2) Eng.D9B (XUD9A/U), DJY (XUD9A) 1.9 D 50kw D9B (XUD9A/U), DJY (XUD9A) 1995-1997, ZX (N2) Eng.DHY (XUD9TE/Y) 1.9 TD 66kw DHY (XUD9TE/Y) 1995-1997, ZX Break (N2) Eng.D9B (XUD9A/U) 1.9 D 50kw D9B (XUD9A/U) 1994-1997, ZX Break (N2) Eng.DHY (XUD9TE/Y) 1.9 TD 66kw DHY (XUD9TE/Y) 1994-1997;

FIAT: SCUDO Box (220_) Eng.D8B 1.9 TD 68kw D8B 1998-2006, SCUDO Box (220_) Eng.D9B 1.9 D 51kw D9B 1996-2006, SCUDO Box (220_) Eng.DHX (XUD9TF/L) 1.9 TD 66kw DHX (XUD9TF/L) 1996-2006, ULYSSE (220_) Eng.DHX (XUD9TF/L) 1.9 TD (220AH5) 66kw DHX (XUD9TF/L) 1995-2002

ALTERNATOR / ALTERNATOR:
BOSCH: 0 123 310 010, 0 123 310 011, 0 123 310 012, 0 123 310 013;

MAHLE: AAK5329, AAK5332;

MAGNETI MARELLI: 943356577010, 944390393000

BOSCH
GA1471 // NEW //
FEATURES / CARACTERÍSTICAS: 120A, diodes 6x50A, B+: M8x24.2mm, External diameter 122mm, with triodiode and capacitor

REPLACES / REEMPLAZA:
Cargo: 138080; **AS-Poland:** ARC0040; **Mobiletron:** RB-110H; **Regitar:** RB-110H

APPLICATION / APLICACIÓN:
AUDI: A4 L4 1.8 1997>1998, Passat L4 1.9 Diesel 1996>1997

VOLKSWAGEN: LT 28-35 II Bus 2.3 1996>2006, LT 28-46 II Box 2.3 1996>2006

MERCEDES-BENZ: C240 2400 1997>2000, C280 2800 V6 1997>2001, CLK320 3200 V6 1997>2003, E240 2400 V6 1997>2002, E280 2800 1996>2003, E320 3200 1997>2002, SL280 2800 1998>2001, SL320 3200 1998>2001, Sprinter 214/314 2300 2000>2006, Sprinter 414 2300 2000>2006

SAAB: 9-5 V6 3.0 1999>2003, 9-5 Estate 3.0 V6 1998>2001

ALTERNATOR / ALTERNATOR:

AUDI / VOLKSWAGEN: 028-903-025F, 028-903-027G, 028-903-028, 028-903-028A, 028-903-028F, 046-903-015F, 046-903-015FX, 054-903-015K, 054-903-015KX, 058-903-016C, 058-903-016CX, 058-903-016D, 058-903-018C, 058-903-018CX, 059-903-015, 059-903-015X, 071-903-016H, 078-903-015F, 078-903-015FX

MB: 010-154-07-02, 010-154-32-02, 011-154-07-02, A0101543202

SAAB: 46-14-475, 49-29-451, 52-46-905

BOSCH
GA1472
FEATURES / CARACTERÍSTICAS: 90A, 8x50A, B+: M8x34mm, External diameter: 122mm

REPLACES / REEMPLAZA:
Cargo: 234357; **AS-Poland:** ARC0106

APPLICATION / APLICACIÓN:
IVECO: Stralis 2002>2013

ALTERNATOR / ALTERNATOR:
BOSCH: 0 123 525 001, 0 123 525 500, 0 123 525 502

IVECO: 500331736, 99477271

BOSCH
GA1510
FEATURES / CARACTERÍSTICAS: 90A, Diodes 6x50A Avalanche (Zener) B+ M8 with diode trio, OD 112mm

REPLACES / REEMPLAZA:
Bosch: 1 127 319 510, 1 127 319 593, 1 127 319 730, 1 127 320 807, 1 127 320 844, 1 127 320 864, 1 127 326 010; **Regitar:** RB-121H;

Cargo: 137333; **WAI/Transpo:** IBR844

APPLICATION / APLICACIÓN:
DIVERSOS: (2000-91) Mercedes 350 450 Saab

ALTERNATOR / ALTERNATOR:

BOSCH: 0113320040, 0120485011, 0120485012, 0120485022, 0123310005, 0123310008, 0123310041, 0123315005, 0123315501, 0123320010, 0123320011, 0123320029, 0123320039, 0123320040, 0123320042, 0123320043, 0123320044, 0123320045, 0123320046, 0123320047, 0123320049, 0123320051, 0123320057, 0123320060, 0123320061, 0123320062, 0123320065, 0123325007, 0123335002, 0123335003, 0123335004, 0123335005, 0123335006, 0123340006, 0123340007

VOLTAGE REGULATOR:
GA211

BOSCH
GA1537

FEATURES / CARACTERÍSTICAS: 80A, 6x35A Diode Avalanche
REPLACES / REEMPLAZA: 1127319554
APPLICATION / APLICACIÓN:
Volvo: S40, V40
ALTERNATOR / ALTERNATOR:
Bosch: 123315021; **Volvo:** 9164940

BOSCH
GA1560

FEATURES / CARACTERÍSTICAS: 90A, Diodes 6x35A Avalanche (Zener), B+ Post M8, with diode trio and capacitor
REPLACES / REEMPLAZA:
Bosch: 1 127 319 560, 1 127 319 011, 1 127 319 746; **Cargo:** 136861
APPLICATION / APLICACIÓN:
IVECO: Trucks Daily Turbo 35.10, 49.10 (after 09.97), Trucks Daily Turbo 35.10, 49.10 (after 09.97);
VW: Saveiro 1.6Mi (AP) without AC (after 06.99), Passat, Variant, Gol II;
AUDI: A80, A100, A4;
PEUGEOT: 306D 1.8i/ 1.8i 16V, 405D 2.0/ 1.8i (after 03.97).
ALTERNATOR / ALTERNATOR:
BOSCH: 0 123 315 500, 0 123 315 020, F 010 LDO 201, 0 123 310 042, 0 123 320 030, F 010 LDO 202
VOLTAGE REGULATOR:
 GA214 / GA223

BOSCH
GA1561

FEATURES / CARACTERÍSTICAS: 90A, Diodes 6x35A Avalanche (Zener) B+ M8 with diode trio, OD 112mm
REPLACES / REEMPLAZA:
Bosch: 1 127 319 766, 1 127 319 726, 1 127 319 530, 1 127 319 599, 1 127 319 725; **Cargo:** 136838; **WAI/Transpo:** IBR570
APPLICATION / APLICACIÓN:
GM: Corsa Wind 96-2000
ALTERNATOR:
BOSCH: 0 123 100 001, 0 123 100 002
VOLTAGE REGULATOR:
 GA212

BOSCH
GA1562

FEATURES / CARACTERÍSTICAS: 120A, 8x50A, Avalanche Diodes, B+ M8X23mm Bolt L M5X17 / with diode trio and capacitor
REPLACES / REEMPLAZA:
Bosch: 1127319766, 1127319765, 1127319601
APPLICATION / APLICACIÓN:
OPEL: Astra Mk3 1400/ 1600/ 1800/ 2000, Calibra A2000, Corsa B 1200/ 1400/ 1600, Omega B 2000/ 2200, Tigra 1400/ 1600, Vectra B 1600/ 1800/ 2000;
VAUXHALL: Vectra
ALTERNATOR:
Bosch: 0 123 120 001
VOLTAGE REGULATOR:
 GA214

BOSCH
GA1563

FEATURES / CARACTERÍSTICAS: 90A, 6x35A Avalanche Diode, B+: M6x12mm M5x8mm, with diode trio and capacitor
REPLACES / REEMPLAZA:
Bosch: 1 127 319 033, 1 127 319 580, 1 127 319 715
APPLICATION / APLICACIÓN:
FORD: Mondeo Mk1 Hatch/Saloon/Estate 1.6i 16V/1.8i 16V/2.0i 16V 93>96, Mondeo Mk2 Hatch/Saloon/Estate 1.6i/1.8i/2.0i 96>00
ALTERNATOR:
Bosch: 0 123 212 001
VOLTAGE REGULATOR:
 GA212, GA214, GA223

BOSCH
GA1570

FEATURES / CARACTERÍSTICAS: 90A, Diodes 6x35A Avalanche (Zener), B+ Post M6, with diode trio and capacitor | Doesn't come with Lamp Terminal
REPLACES / REEMPLAZA:
Bosch: 1 127 319 570; **Regitar:** RB-105H; **Cargo:** 137507; **WAI/Transpo:** IBR570; **Magneti Marelli:** PR520498
APPLICATION / APLICACIÓN:
FORD: Ka 1.0/ 1.3i, Courier 1.0, 1.3i, Fiesta 1.0, 1.3
ALTERNATOR / ALTERNATOR:
BOSCH: 0 123 320 050, 0 123 310 023, 0 123 310 048, 0 123 310 054, 0 123 310 055, 0 123 310 067
VOLTAGE REGULATOR:
 GA523

BOSCH
GA1584

FEATURES / CARACTERÍSTICAS: 90A, Diodes 6x35A Avalanche (Zener), B+ Post M6, with diode trio and capacitor | Doesn't come with Lamp Terminal

REPLACES / REEMPLAZA:

Bosch: 1 127 319 584, 1 127 320 870; **Cargo:** 135444; **Magneti Marelli:** PR520500

APPLICATION / APLICACIÓN:

FORD: Escort Zetec 16v 1.8i, Fiesta, Orion, Scorpio II

ALTERNATOR / ALTERNATOR:

BOSCH: 0 120 485 029, 0 123 310 014, 0 123 310 015, 0 123 310 029, 0 123 310 053, 0 123 320 014

BOSCH
GA1667

FEATURES / CARACTERÍSTICAS: 90A, Diodes 8x35A Avalanche (Zener), B+ Post M8, with diode trio and capacitor

REPLACES / REEMPLAZA:

Bosch: 1 127 319 667, 1 127 320 850; **Regitar:** RB-24H; **Cargo:** 135439; **WAI/Transpo:** IBR850

APPLICATION / APLICACIÓN:

VW: Cabrio, Corrado, Eurovan, Golf, Jetta, Passat;

BMW;

MERCEDES BENZ

ALTERNATOR / ALTERNATOR:

BOSCH: 0 120 485 036, 0 120 485 038, 1 120 485 039, 0 123 320 001, 0 123 320 002, 0 123 320 005, 0 123 340 002, 0 123 340 003, 0 123 340 005

VOLTAGE REGULATOR:

GA212 / GA223

BOSCH
GA1671

FEATURES / CARACTERÍSTICAS: 75A, Diodes 6x35A Avalanche (Zener), B+ Post M6, with diode trio and capacitor

REPLACES / REEMPLAZA:

Bosch: 1 127 319 671; **Cargo:** 139571

APPLICATION / APLICACIÓN:

HONDA: Civic 1.4i 95-01; Civic 1.5i 94-01, 1.4, 1.5, 1.6 de 95>01

ALTERNATOR / ALTERNATOR:

BOSCH: 0 123 315 020

BOSCH
GA1852

FEATURES / CARACTERÍSTICAS: 90A, Diodes : 6x35A Avalanche (Zener), B+ Post M8, with diode trio and capacitor

REPLACES / REEMPLAZA:

Bosch: 1 127 319 552, 1 127 320 852, 1 127 319 728; **Regitar:** RB-122H; **Cargo:** 138077; **WAI/Transpo:** IBR852

APPLICATION / APLICACIÓN:

VW: Golf GL 2.0/ GLX (after 03.96). Polo Classic 1.6 Mi, 1.8 Mi (AP) Van 1.6 Mi with AC (after 02.97) Gol/ Parati 1.0 Mi/ 1.0 Mi 16V without AC (after 09.97), Polo, Classic 1.6 Mi, 1.8 Mi (AP), Van 1.6 Mi without AC (after 02.97), Bora, New Batle 2.0, Caravelle, Eurovan, Jetta, Passat;

SEAT: Cordoba, Ibiza, Inca, Toledo;

AUDI: A3 1.6, 1.8/ Diesel;

BMW; MERCEDES BENZ;

ALTERNATOR / ALTERNATOR:

AUDI / VW: 023 903 023, 028 903 018, 023 903 025G, 023 903 025P, 023 903 025Q, 030 903 023B **BOSCH:** 0 120 335 007, 0 120 340 003, 0 120 485 034, 0 120 485 043, 0 120 485 044, 0 123 310 001, 0 123 310 002, 0 123 310 018, 0 123 310 019, 0 123 310 020, 0 123 310 024, 0 123 310 025, 0 123 310 032, 0 123 310 034, 0 123 310 035, 0 123 310 037, 0 123 310 038, 0 123 310 039, 0 123 310 040, 0 123 310 046, 0 123 310 049, 0 123 315 001, 0 123 315 002, 0 123 315 006, 0 123 315 021, 0 123 315 501, 0 123 320 006, 0 123 320 007, 0 123 320 008, 0 123 320 017, 0 123 320 018, 0 123 320 019, 0 123 320 024

VOLTAGE REGULATOR:

GA223

BOSCH
GA1734

FEATURES / CARACTERÍSTICAS: 120A, Diodes Avalanche (Zener) 6x50A, B+ Post M8, with diode trio and capacitor

REPLACES / REEMPLAZA:

Bosch: 1 127 319 734, 1 127 319 540, 1 127 319 572; **Regitar:** RB-107H; **Cargo:** 230093; **WAI/Transpo:** IBR856

APPLICATION / APLICACIÓN:

AUDI: A3 1.6, 1.8, 1.8T;

SEAT: Alhambra 2.7 V8;

SKODA: Octavia 1.6;

VW: Golf, Corrado, Eurovan, Caravelle, Multivan, Transports, California

ALTERNATOR / ALTERNATOR:

BOSCH: 0 123 510 053, 0 123 510 054, 0 123 510 065, 0 123 515 016

VOLTAGE REGULATOR:

GA223

BOSCH
GA1737

FEATURES / CARACTERÍSTICAS: 130A, Diods 8x60A Avalanche (Zener), B+ M8, with diode trio, OD 122mm

REPLACES / REEMPLAZA:
Bosch: 1 127 319 501, 1 127 319 578, 1 127 319 752; **Cargo:** 230173; **WAI/Transpo:** IBR501

APPLICATION / APLICACIÓN:
VW: Golf Tdi 1.9 1993-1997, Jetta 1.9 Tdi 1993-1998, Caddy 1.9 Tdi 1995-2000, Derby 1.7 /1.9 1996-2001, Polo Tdi 1.7 /1.9 1997-2001

ALTERNATOR / ALTERNATOR:
BOSCH: 0123505011, 0123505012, 0123505013, 0123515017; **VW/AUDI:** 028903025S, 028903026G, 028903027D, 028903028B

BOSCH
GA1738

FEATURES / CARACTERÍSTICAS: 130A, Diods Avalanche (Zener) 8x50A, B+ Post M8, with diode trio and capacitor

REPLACES / REEMPLAZA:
Regitar: RB-178H; **Cargo:** 230092; **WAI/Transpo:** IBR738

APPLICATION / APLICACIÓN:
VW: Golf 1.6, 1.8, 1.9, 2.0, Passat 2.0, 2.0 16V, Sharan 2.0;

Vento 1.6,1.8, 1.9 TDi, Transporter 1.9, 2.0, 2.5, Conrado 2.8 V6, 2.9 VR6;

SEAT: Alhambra 2.0, Ibiza 1.8 16V;

FORD: Galaxy 2.8 VR6 UP 1995;

VOLVO: 260 série, 760 2.8 V6

ALTERNATOR / ALTERNATOR:
BOSCH: 0 123 510 005, 0 123 510 006, 0 123 510 007, 0 123 515 032

BOSCH
GA1739

FEATURES / CARACTERÍSTICAS: 120A, Diods Avalanche (Zener) 8x35A, B+ Post M8, with diode trio and capacitor

REPLACES / REEMPLAZA:
Bosch: 1 127 319 708

APPLICATION / APLICACIÓN:
MERCEDES BENZ:

ECOPOWER 90

ALTERNATOR / ALTERNATOR:
BOSCH: 6 004 LA9, 0 123 512 501, 0 123 512 502

BOSCH
GA1740

FEATURES / CARACTERÍSTICAS: 700A, Diods Avalanche (Zener) 6x35A, B+ Post M8, with diode trio and resistor

REPLACES / REEMPLAZA:
Bosch: 1 127 319 013, 1 127 319 597, 1 127 319 778; **Cargo:** 136831; **Magneti Marelli:** PR520527

APPLICATION / APLICACIÓN:
GM: Calibra, Corsa, Omega, Vectra, Astra, Frontera;

SAAB: 900 2.5 V6 SE

ALTERNATOR / ALTERNATOR:
BOSCH: 0 123 505 001, 0 123 505 004, 0 123 510 003, 0 123 510 020

VOLTAGE REGULATOR:

GA214

BOSCH
GA1741

FEATURES / CARACTERÍSTICAS: 140A, Diods 14x50A Avalanche (Zener), B+ M8, with diode trio, OD 122mm

REPLACES / REEMPLAZA:
Bosch: 1 127 319 712, 1 127 319 641; **Cargo:** 139939-139030

APPLICATION / APLICACIÓN:
BMW: 316I /316CI /318I Z3 1.9, M5 V8 5.0L 4941cc 2000-2003, Z8 V8 5.0L 4941cc 2000-2003

ALTERNATOR / ALTERNATOR:
BOSCH: 0 123 325 010

BOSCH
GA1742

FEATURES / CARACTERÍSTICAS: 90A, Diods 6x 35A Avalanche, Parafuso B+ M6, with diode trio, OD 112mm

REPLACES / REEMPLAZA:
Bosch: 1 127 319 583, 1 127 319 584; **Cargo:** 135444

APPLICATION / APLICACIÓN:
FORD: Escort Zetec 16V 1.8i, Fiesta, Orion, Scorpion II

ALTERNATOR / ALTERNATOR:
BOSCH: 0120485029, 0123310014, 0123310015, 0123310053, 0123310029, 0123320014

BOSCH
GA1743

FEATURES / CARACTERÍSTICAS: 90A, Diodes 6x 50A Avalanche, B+ M8, with diode trio, Diameter 112mm

REPLACES / REEMPLAZA:

Bosch: 1 127 319 009, 1 127 319 617, 1 127 319 623, 1 127 319 816, 1 127 320 862, 1 127 320 882; **Cargo:** 137257

APPLICATION / APLICACIÓN:

BMW: 318i 1994-1995, 316 europe 1600 /1800 /1900 1993-2000

ALTERNATOR / ALTERNATOR:

BMW: 12311247287, 12311247311, 12314353353; **BOSCH:** 0 123 310 0064

BOSCH
GA1543

FEATURES / CARACTERÍSTICAS: 105A, Diodes 14x35A, 3x35A diode trio, Terminal B+ M8, Terminal B- M6, Terminal D+M4

REPLACES / REEMPLAZA:

Bosch: 1 127 319 560, 1 127 320 543, 1 127 320 361, 1 127 320 379, 1 127 320 388, 1 127 320 395, 1 127 320 653, 1 127 320 655, 1 127 320 959; **Audi:** 049 903 359D; **Ford:** 613319, 83DB10304AA; **Magneti Marelli:** 940 038 360; **Mercedes Benz:** 1543316, 1544716, 1546616, 1546916, 11541216, 11541516; **Scania:** 1314207, 1342386, 424968;

Regitar: RB-72H; **WAI/Transpo:** IBR340; **Cargo:** 139581

APPLICATION / APLICACIÓN:

MERCEDES BENZ;

SCANIA;

VOLVO: Trucks and Bus. alternators Bosch 28V.

ALTERNATOR / ALTERNATOR:

BOSCH: 0 120 469 518, 0 120 469 521, 0 120 469 532, 0 120 469 569 alternators 28 V

VOLTAGE REGULATOR:

GA301

BOSCH
GA1920

FEATURES / CARACTERÍSTICAS: 135A, Diodes 14x50A, 3x35A diode trio, Terminal B+ 7/16" (11mm), Terminal B- M6, Terminal D+ M4, W Terminal M5

REPLACES / REEMPLAZA:

Bosch: 1 127 320 920; **Regitar:** RB-67H; **Cargo:** 136737; **WAI/Transpo:** IBR954

APPLICATION / APLICACIÓN:

JI CASE: Tractors. Alternators Bosch 28V - 135A.

ALTERNATOR / ALTERNATOR:

BOSCH: 0 120 468 028, 0 120 468 055

VOLTAGE REGULATOR:

GA025

BOSCH
GA1954

FEATURES / CARACTERÍSTICAS: 140A, Diodes 8x50A Avalanche (Zener), 3x35A diode trio, Term. B+ 7/16" (11mm), Terminal B- M6, Terminal D+ M4, W Terminal M5.

REPLACES / REEMPLAZA:

Bosch: 1 127 320 954; **Regitar:** RB-67H; **Cargo:** 136737; **WAI/Transpo:** IBR954A

APPLICATION / APLICACIÓN:

JI CASE: Harvesters 2155, 2166, 2188, 2366, 2388, 2555. (Cummins 6T 8.3L) (05.97.) Tractors 8910, 8920, 8930, 8940, 8950, (Cummins 6T 8.3L) (05.97). **JOHN DEERE:** Alternators Bosch 14V.

ALTERNATOR / ALTERNATOR:

BOSCH: 0 120 468 028, 0 120 468 055 can not be used with alternators 28V

VOLTAGE REGULATOR:

GA025

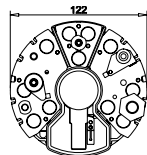
BOSCH
GA1955

FEATURES / CARACTERÍSTICAS: 105A, Diodes 8x35A, 3x35A diode trio, Terminal B+ M8, Terminal B- M6, Terminal D+ M4, W Terminal M5

REPLACES / REEMPLAZA:

Bosch: 1 127 320 955, 1 127 320 951, 1 127 320 980, 1 127 320 981, 1 127 320 602, 1 127 320 924; **Cargo:** 136832; **WAI/Transpo:** IBR955

APPLICATION / APLICACIÓN:

SCANIA: Trucks and Bus;

DAF;

KHD;

MAN

ALTERNATOR / ALTERNATOR:

BOSCH: 0 120 468 037, 0 120 468 053, 0 120 468 115, 0 120 468 118, 0 120 469 686, 0 120 469 687, 0 120 469 895. Bosch 28V - 80A

VOLTAGE REGULATOR:

GA301

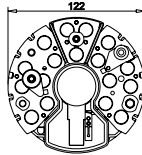
BOSCH
GA1959

FEATURES / CARACTERÍSTICAS: 140A, Diodes 14x35A, 3x35A diode trio, Terminal B+ M8, Terminal B- M6, Terminal D+ M4, W Terminal M5.

REPLACES / REEMPLAZA:

Bosch: 1 127 320 961, 1 127 320 959; **Cargo:** 139581; **WAI/Transpo:** IBR341; **Mobiletron:** RB-62H, **Regitar:** RB-62H

APPLICATION / APLICACIÓN:

SCANIA;
VOLVO;
MERCEDES BENZ;
DAF;

ALTERNATOR / ALTERNATOR:

BOSCH: 0 120 469 522, 0 120 469 749. Bosch 28V - 90A

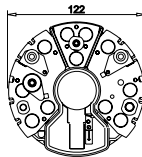
BOSCH
GA1968

FEATURES / CARACTERÍSTICAS: 105A, Diodes 8x35A, 3x35A diode trio, Terminal B+ M8, Terminal B- M6, Terminal D+ M4, W Terminal M5

REPLACES / REEMPLAZA:

Bosch: 1 127 320 968, 1 127 320 904; **Scania:** 1318551, 1345630; **DAF:** 068092; **Regitar:** RB-64H; **Cargo:** 230729;

WAI/Transpo: IBR904

APPLICATION / APLICACIÓN:

SCANIA: Trucks and Bus;

DAF;
KHD;
MAN (USA);

ALTERNATOR / ALTERNATOR:

BOSCH: 0 120 469 041, 0 120 469 796, 0 120 469 963, 0 120 469 983. Bosch 28V - 50A

VOLTAGE REGULATOR:

GA365

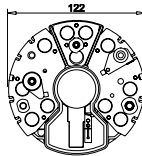
BOSCH
GA1977

FEATURES / CARACTERÍSTICAS: 105A, Diodes 8x35A, 3x35A diode trio, Terminal B+ M8/M6, Terminal B - M6, Terminal D+ M4, W Terminal M5

REPLACES / REEMPLAZA:

Bosch: 1 127 320 977, 1 127 320 590; **Scania:** 102644, 1344240, 362644; **Regitar:** RB-63H; **Cargo:** 134609; **WAI/Transpo:** IBR590

APPLICATION / APLICACIÓN:

SCANIA: Trucks and Bus

ALTERNATOR / ALTERNATOR:

BOSCH: 0 120 468 037, 0 120 468 053, 0 120 468 115, 0 120 468 118, 0 120 468 686, 0 120 468 687, 0 120 468 895. Bosch 28V - 50A

VOLTAGE REGULATOR:

GA301

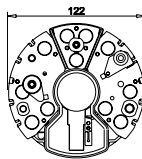
BOSCH
GA1989

FEATURES / CARACTERÍSTICAS: 105A, Diodes 8x35A Avalanche (Zener), 3x35A diode trio, Terminal B+ M8, Terminal B- M6, Terminal D+ M4, W Terminal M5

REPLACES / REEMPLAZA:

Bosch: 1 127 320 989, 1 127 320 928, 1 127 320 946, 1 127 320 956, 1 127 320 969, IBR 989; **Scania:** 102644, 1344240, 362644;

Regitar: RB-71H; **Cargo:** 136832; **WAI/Transpo:** IBR989

APPLICATION / APLICACIÓN:

MERCEDES BENZ: Trucks 609, 611, 614, 709, 711, 714, 809, 811, 814, 914, 917, 1114, 1320, 15140;

SCANIA: Chassis for Bus OF1315, OF1318, OH1418/ 1635 OF1113 (OM352), Trucks L1117 (USA), LPS1525/ Bus O390D. Chassis for Bus OH1318. Trucks MT-DS 11.94, 95, 96, 97, DS14.52, DSC 11.56, 57, 58, 14.57, 61, 62, 63 and others;

VOLVO: Trucks and Bus; IVECO; KHD

ALTERNATOR / ALTERNATOR:

BOSCH: 0 120 468 037, 0 120 468 053, 0 120 468 107, 0 120 468 113, 0 120 468 114, 0 120 468 115, 0 120 468 118, 0 120 468 131, 0 120 468 137, 0 120 468 149, 0 120 469 013, 0 120 469 895, 0 986 037 770, 6033 GB3 006, 6033 GB3 008, 6033 GB3 033, 6033 GB3 034, 6033 GB3 054. Bosch 28V - 80A

VOLTAGE REGULATOR:

GA301 / GA304

BOSCH
GA1995

FEATURES / CARACTERÍSTICAS: 90A, 8x35 Diodes Avalanche (Zener) 35A, diode trio, B+ Post M8, B+ Post M8

REPLACES / REEMPLAZA:

Bosch: 1 127 320 995, 1 127 320 928, 1 127 320 946, 1 127 320 969, 1 127 320 989; **Magneti Marelli:** 940 038 364;

Mercedes Benz: 11542116; **Scania:** 1387615; **Regitar:** RB-71H; **Cargo:** 136832, 139581; **WAI/Transpo:** IBR989

APPLICATION / APLICACIÓN:

IVECO: Trucks 190-36, 190-36P, 190-36T, 190-38, 190-38PT, 190-36, 220-36, 240-36, 240-36P, 260-36;

MERCEDES BENZ: Bus OF 1113, Oh 1113, 917;

VOLVO: Trucks NL 10, NL 12, Chassi for Bus B12.

ALTERNATOR / ALTERNATOR:

BOSCH: 0 120 468 094, 0 120 469 025, 0 120 469 014, 0 120 469 749, 0 120 469 026, 0 120 469 526, 0 120 469 532

VOLTAGE REGULATOR:

GA304

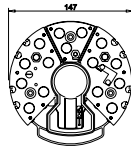
BOSCH
GA1065

FEATURES / CARACTERÍSTICAS: 95A, 12x35A diode 12x35A, B+ Post1/4x45, D+ Post 3/16x30, W Post 3/16x40

REPLACES / REEMPLAZA:

Bosch: 9 121 456 065

APPLICATION / APLICACIÓN:

CARGO: Trucks 1113 / 1114 / 1117 / 1215 / 1218 / 1313 / 1314 / 1317 / 1415 / 1418 / 1514 todos 1419 / 1619 / 2319 / 35300 (after 10.90), F6000 / 7000 (after 06.87).

ALTERNATOR / ALTERNATOR:

BOSCH: 9 120 456 004, 9 120 456 005, 9 120 456 013, 9 120 456 024, 9 120 456 025. Bosch 28V - 70A

VOLTAGE REGULATOR:

GA008 / GA008N

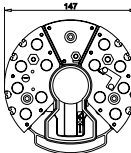
BOSCH
GA1547

FEATURES / CARACTERÍSTICAS: 140A, 14x50A Diodes Avalanche (Zener), 3x35A diode trio, B+ Post M8, Post B- M8, with Resistor

REPLACES / REEMPLAZA:

Bosch: 1 127 320 547, 1 127 320 550, 1 127 320 571; **Cargo:** 136581; **Mercedes Benz:** 1545116, 1545416; **Regitar:** RB-78HA;

WAI/Transpo: IBR547

APPLICATION / APLICACIÓN:

MERCEDES BENZ: Bus e Trucks;

SCANIA: Bus and Chassi F112HL, 113, K113CL, K113TL, L113CL, S113AL, S113CL;

VALMET: Tractors with alternator 90A;

VME: Trucks off road;

VW: Trucks 16.180 e 16.210 w/ engine MWM 6.10 (83 a 86);

RECROSUL: Chassi for Bus;

RANDOM: Trucks off road;

MAFERSA: Bus M210 e M240 (after 91), Trolebus;

MAXION: Engine 4236;

VOLVO: Bus B58 and B10M.

ALTERNATOR / ALTERNATOR:

BOSCH: 0 120 488 158, 0 120 488 159, 9 120 456 001, 9 120 456 003, 9 120 456 008, 9 120 456 010, 9 120 456 011, 9 120 456 012,

9 120 456 014, 9 120 456 028, 9 120 456 031, 9 120 456 032, 9 120 456 033, 9 120 456 034, 9 120 456 036, 9 120 456 037, 9 120 456 038,

9 120 456 039, 9 120 456 040, 9 120 456 041, 9 120 456 042, 9 120 456 043, 9 120 456 044, 9 120 456 046, 9 120 456 047, 9 120 456 048,

9 120 456 050, F006 LD0-800

VOLTAGE REGULATOR:

GA041 / GA041R / GA042 / GA42R / GA043

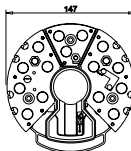
BOSCH
GA1973

FEATURES / CARACTERÍSTICAS: 140A, 12x50A Diodes, 3x35A trio Diode, B+ Post M8, with resistor

REPLACES / REEMPLAZA:

Bosch: 1 127 320 973, 9 121 456 212; **Mercedes Benz:** 11540816; **Scania:** 1347012; **Regitar:** RB-78H; **Cargo:** 136581;

WAI/Transpo: IBR973

APPLICATION / APLICACIÓN:

MERCEDES BENZ: Trucks and Bus;

IVECO: 3801029;

RENAULT: Agora, Ares, Iliade, Tracer, R332 Line1;

SCANIA: K113, L113, N113, F94, K124EB Bus, K124IB Bus;

VOLVO: B10M, B7L

ALTERNATOR / ALTERNATOR:

BOSCH série T1 (140A): 0 120 689 535, 0 120 689 562, 9 120 456 049, 9 120 456 052

VOLTAGE REGULATOR:

GA041 / GA041R

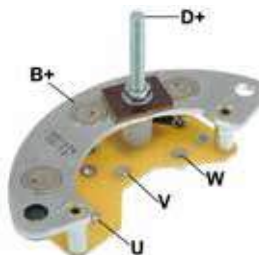
BOSCH
GA1374

FEATURES / CARACTERÍSTICAS: 55A, 3x35A Diodes

REPLACES / REEMPLAZA:

Bosch: 9 121 080 374

APPLICATION / APLICACIÓN:

MWM;

VALMET;

CATERPILLAR

ALTERNATOR / ALTERNATOR:

BOSCH: 9 120 080 045, 9 120 080 049, 9 120 080 057, 9 120 080 085, 9 120 080 094, 9 120 080 107, 9 120 080 138, 9 120 080 146

VOLTAGE REGULATOR:

GA001 / GA011 / GA012 / GA013

BOSCH
GA1595

FEATURES / CARACTERÍSTICAS: 55A, 6x35A Diodes, B+ Post M6, with diode trio

REPLACES / REEMPLAZA:

Bosch: 9 121 080 595; **Regitar:** RB-137HV; **WAI/Transpo:** IBR595; **Magneti Marelli:** PR520501

APPLICATION / APLICACIÓN:

VW: Kombi, Brasília alcohol 1300, Brasília 1600, Volks Sedan.

ALTERNATOR / ALTERNATOR:

BOSCH: 9 120 080 041, 9 120 080 061, 9 120 080 072, 9 120 080 090, F000 LD0108

VOLTAGE REGULATOR:

GA003 / GA999

BOSCH / WAPSA
GA1004

FEATURES / CARACTERÍSTICAS: 55A, 3x35A Diodes

REPLACES / REEMPLAZA:

Bosch: 9 121 450 310, 9 121 450 311, 9 121 450 533; **Wapsa:** 415-1, 415-26, 415-36, 415-38, 415-39

APPLICATION / APLICACIÓN:

FORD: Del Rey, Scala, Corcel II, Belina, Pampa (after 10/82);

VW: Truck E-11, E-13, alcohol 8 cil., Truck 6.80, 6.90, 7.90, 7.110, 12.140, 11.130, 11.160, 13.130, 13.160 with enginer MWM;

AGRALE: Tractor T-4100, T4200, T4300;

CLARK: Tractor Bob Cat M-711-MS;

MF: Tractor MF after 07/78.

ALTERNATOR / ALTERNATOR:

BOSCH: 9 190 450 042, 9 190 450 044, 9 190 450 052, 9 190 450 071, 9 190 450 100, 9 190 450 101, 9 190 450 102, 9 190 450 113, 9 190 450 118, 9 190 450 119

BOSCH / WAPSA
GA1006

FEATURES / CARACTERÍSTICAS: 55A, 3x35A Diodes, with diode trio

REPLACES / REEMPLAZA:

Bosch: 9 121 450 310, 9 121 450 311, 9 121 450 533; **Wapsa:** 415-1, 415-26, 415-36, 415-38, 415-39; **Magneti Marelli:** PR520404

APPLICATION / APLICACIÓN:

FORD: Del Rey, Scala, Corcel II, Belina, Pampa (after 10.82), Truck with enginer MWM 4/6 e Tractors;

VW: Truck E-11, E-13, with enginer álcool 8cil., Micro Bus, Truck 6.80 with enginer Perkins, Truck 6.90, 7.90, 7.110, 12.140, 11.130, 11.160, 13.130, 13.160 with enginer MWM.

ALTERNATOR / ALTERNATOR:

WAPSA: ARA13037, ARA14020, ARA15024, ARC13029, ARC13030, ARC14028, ARC14056, ARC15077, ARC15151, ART13035, ART13036, ART13041, ART13063, ART13136, ART15168; **BOSCH:** 9 120 450 042, 9 120 450 044, 9 120 450 052, 9 120 450 053, 9 120 450 058, 9 120 450 071, 9 120 450 085, 9 120 450 090, 9 120 450 092, 9 120 450 093, 9 120 450 100, 9 120 450 102, 9 120 450 113, 9 120 450 130, 9 120 450 132, 9 120 450 132

VOLTAGE REGULATOR:

GA001 / GA011 / GA058

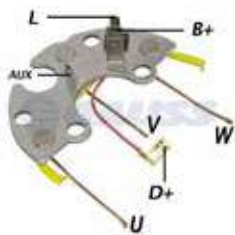
BOSCH / WAPSA
GA1522

FEATURES / CARACTERÍSTICAS: 85A, 3x35A Diodes, with diode trio

REPLACES / REEMPLAZA:

Bosch: 9 121 450 587; **Wapsa:** 415-22

APPLICATION / APLICACIÓN:

VW: Kombi diesel, Gol gas/alcohol, Passat, Voyage, Santana.

ALTERNATOR / ALTERNATOR:

BOSCH: 9 120 450 110

VOLTAGE REGULATOR:

GA007

BOSCH / WAPSA
GA1529

FEATURES / CARACTERÍSTICAS: 60A, 3x35A Diodes

REPLACES / REEMPLAZA:

Bosch: 9 121 450 313; **Wapsa:** 415-29

APPLICATION / APLICACIÓN:

FORD: Truck Cargo 1218 / 1415 / 1418 / 1519 / 1521 / 1618 / 1621 / 2218 / 2319 / 2321 / 3021 / 3223 w/ engine FORD 6.6 / 7L.

ALTERNATOR / ALTERNATOR:

WAPSA: ARC14096, ARC16097; **BOSCH:** 9 120 450 080, 9 120 450 083, 9 120 450 128, 9 120 450 006

VOLTAGE REGULATOR:

GA008 / GA008N

BOSCH / WAPSA
GA1574

FEATURES / CARACTERÍSTICAS: 60A, 3x35A Diodes

REPLACES / REEMPLAZA:

...

APPLICATION / APLICACIÓN:

FORD: Cargo 1218/ 1415/ 1418/ 1618/ 2218 w/ engine FORD 6.6L;

NEW HOLLAND: Combine 8040/ 8055;

VW: Truck 16.170/ 14.170/ 14.210/ 16.210 with enginer Cummins Série (original reference 9 120 450 013). Truck 13.210/ 15.210/ 22.210 with Cummins C series.

ALTERNATOR / ALTERNATOR:

BOSCH: 9 120 450 073, 9 120 450 129, 9 120 450 133, 9 120 450 134, 9 120 450 014, 9 120 450 137; **WAPSA:** AKC16123, AKC14122

VOLTAGE REGULATOR:

GA059

CHERY
GA1602

FEATURES / CARACTERÍSTICAS: 105A, 6x35A avalanche diodes, with diode trio

REPLACES / REEMPLAZA:

Chery: JFZ1756-1

APPLICATION / APLICACIÓN:

Chery: QQ/Face 1.1 16V

ALTERNATOR / ALTERNATOR:

Chery: S11-3701110BA; JFZ1753; 3701AAJ

VOLTAGE REGULATOR:

GA602

CHERY
GA1603

FEATURES / CARACTERÍSTICAS: 105A, 6x35A avalanche diodes, with diode trio
REPLACES / REEMPLAZA:
Chery: JFZ1756-1
APPLICATION / APLICACIÓN:
Chery: QQ/Face 1.1 16V
ALTERNATOR / ALTERNATOR:
Chery: S11-3701110BA, JFZ1753, 3701AAJ
VOLTAGE REGULATOR:
 GA603

CHERY
GA1605

FEATURES / CARACTERÍSTICAS: 110A, 6x50A Avalanche Diode, B+: M8x12mm, with triodiode
REPLACES / REEMPLAZA:
 ...
APPLICATION / APLICACIÓN:
CHERY: Fora, M11, Tiggo
ALTERNATOR / ALTERNATOR:
Chery: JFZ1992, B11-3701110BB, 3701AAG
VOLTAGE REGULATOR:
 GA601

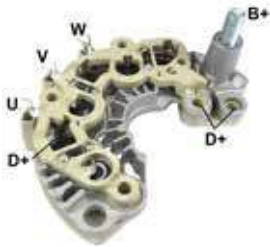
CHERY
GA1608

FEATURES / CARACTERÍSTICAS: 110A, 6x50A, B+: M8x14mm, Avalanche Diode, with diode trio, Diameter: 114mm
REPLACES / REEMPLAZA:
 ...
APPLICATION / APLICACIÓN:
JAC: J6 Diamont 2.0 16V, Refine
ALTERNATOR / ALTERNATOR:
Chery: JFZ1929D
VOLTAGE REGULATOR:
 GA608

DAEWOO
GA1871

FEATURES / CARACTERÍSTICAS: 105A, Press-Fit Diodes 6x50A Avalanche Diode(Zener) With Diode Trio
REPLACES / REEMPLAZA:
Daewoo: 96206871; **GM:** 96206871
APPLICATION / APLICACIÓN:
DAEWOO: 1999>2001 11SI Series Leganza 2.2L Delphi
ALTERNATOR / ALTERNATOR:
 Delco Korea / Daewoo 11SI Series 105A IR/IF Alternators

DAEWOO
GA1938 // NEW //

FEATURES / CARACTERÍSTICAS: 85A, Diodes 8x35A, External Diameter 103mm, with trio diode
REPLACES / REEMPLAZA:
Cargo: 138389; **AS-Poland:** ARC1020; **Transpo:** DR5166
APPLICATION / APLICACIÓN:
CHEVROLET: Lacetti 1.8 2005, Rezzo 2.0 2005>2008
DAEWOO: Leganza 2.0 16V 1997>2002, Nubira 1800/2000 1997>2005, Nubira saloon 1.8/2.0 1997>2005, Tacuma 2000 2000>2005
ALTERNATOR / ALTERNATOR:
DAEWOO: 96221945, 96252115; **CHEVROLET:** 96221945
VOLTAGE REGULATOR:
 GA416

DAEWOO
GA1940

FEATURES / CARACTERÍSTICAS: 120A, Diodes 6x50A, with diode trio
REPLACES / REEMPLAZA:
Daewoo: 266000; **Regitar:** RD-32; **Mobiletron:** RD-32; **Cargo:** 235027; **WAI/Transpo:** DR9410; **AS Poland:** ARC1034
APPLICATION / APLICACIÓN:
GM: Mercury Marine V8;
DAEWOO: Matiz;
MERCURUISER: (1998-2002)
ALTERNATOR / ALTERNATOR:
DELCO: 19020601, 19020612; **DAEWOO:** 219170, 96314258, 219232; **MERCMARINE:** 862031, 862031T, 862031T1, 863077T;
PRESTOLITE: 20115018TBA

DELCO
GA1828

FEATURES / CARACTERÍSTICAS: 85A, 3x35A Diodes

REPLACES / REEMPLAZA:

Delco: 1.959.828; **Cargo:** 233234; **WAI/Transpo:** 31-100

APPLICATION / APLICACIÓN:

GM: Opala, Veraneio, Pick up, Truck

ALTERNATOR / ALTERNATOR:

DELCO: A124N, A12M, A19326-1, ALB40N68, ALB40N86, 1100074, 1100748, 7111, 7113, 7122, 7140, 7142, 7143, 7146, 7149, 7156, 7167, 7208, 7212, 7214, 7218, 7219.

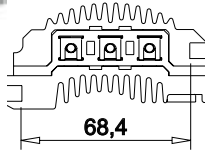
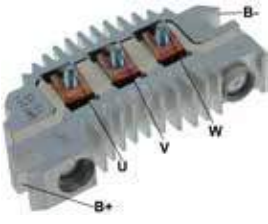
DELCO
GA1311

FEATURES / CARACTERÍSTICAS: 65A, 6x35A Diodes, Heavy Duty

REPLACES / REEMPLAZA:

Delco: 3472311, 7982716, 7982718; **Cargo:** 130667; **Lucas:** 21226106, 21226109, UBB 701; **Magneti Marelli:** 940 038 216, PR520437; **Regitar:** RD-10; **WAI/Transpo:** DER1000

APPLICATION / APLICACIÓN:

GM: Monza all with alternator Arno 82 to 90, Kadett all with alternator Arno 91

ALTERNATOR / ALTERNATOR:

DELCO: 3720002, 3720004, 3720008, 3720014, 3720018, 3720022, 3720023, 3720024, 3720026, 3720027, 3720028, 3720032, 3720037, 3720038

VOLTAGE REGULATOR:

GA201 / GA203

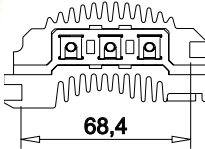
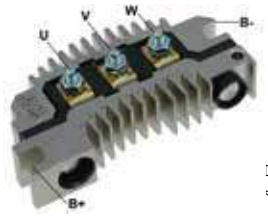
DELCO
GA1312

FEATURES / CARACTERÍSTICAS: 120A, 6x55A Diodes, Heavy Duty

REPLACES / REEMPLAZA:

Delco: 7332312; **Magneti Marelli:** PR520438

APPLICATION / APLICACIÓN:

GM: Chevette all 73>, Opala all 75-91, Pick up all with alternator Arno

ALTERNATOR / ALTERNATOR:

DELCO: 3720002, 3720004, 3720008, 3720014, 3720018, 3720022, 3720023, 3720024, 3720026, 3720027, 3720028, 3720032, 3720037, 3720038

VOLTAGE REGULATOR:

GA200 / GA202

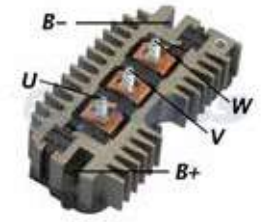
DELCO
GA1627

FEATURES / CARACTERÍSTICAS: 120A, Diodes 6x50A, Heavy Duty

REPLACES / REEMPLAZA:

Delco: 1852209, 1875627, 1891055, 1984638, 1971987, DR5042, DR5000, D3915; **Regitar:** RD-09; **Cargo:** 130673; **WAI/Transpo:** DR5040

APPLICATION / APLICACIÓN:

AMC;
CHEVROLET;
GMC;
JEEP;
OLDSMOBILE;
PONTIAC;

ALTERNATOR / ALTERNATOR:

DELCO: 1100 series, 1102 series, 1103 series, 1105 series, 321 series, 1100109, 1100110, 1100111, 1100113, 1100115, 1100116, 1100117, 1100119, 1100120, 1100121, 1100122, 1100124

DELCO
GA1628

FEATURES / CARACTERÍSTICAS: 105A, Diodes 6x35A button

REPLACES / REEMPLAZA:

Delco: 1875645, 1892914, 801816, D3982, D3983;

Caterpillar: 9L6776

APPLICATION / APLICACIÓN:

GM: Passenger Car, Heavy Truck

ALTERNATOR / ALTERNATOR:

DELCO: 10456313, 10459001, 10459002, 10459008, 10459009, 10459057, 10459058, 10459079, 10459097, 10459116, 10459120, 10459138, 10459234, 10459237, 10459238, 10459244, 10459259, 10459260, 10459368, 10459369, 10459452, 10463072, 10463073, 0463100, 10463160, 10463307, 10463308, 10497177, 1100072, 1100073, 1100077, 1100078, 1100080, 1100081, 1100084, 1100086, 100087, 1100089, 1100090, 1100091, 1100093, 1100094, 1100095, 1100096, 1100177, 1100185, 1100188, 1100189, 1100210, 1100211, 100212, 1100213, 1100216, 100274, 1101015, 1101016, 1101017, 1101018, 1101019, 1101020, 1101021, 1101022, 1101023, 1101024, 101025

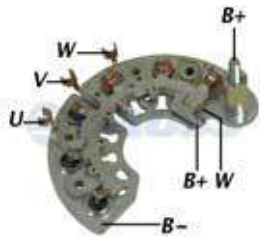
DELCO
GA1400

FEATURES / CARACTERÍSTICAS: 120A, Diodos Avalanche (Zener) 6x50A

REPLACES / REEMPLAZA:

Delco: 10494503; **Regitar:** RD-26HD; **Cargo:** 232668; **WAI/Transpo:** DR4402HD

APPLICATION / APLICACIÓN:

Chevrolet;
GMC;

ALTERNATOR / ALTERNATOR:

DELCO: 10464439, 10464455, 10464459, 10464478, 10464481, 10464483, 10464484, 10464490, 10464491, 10480229, 10480241, 10480271, 10480285, 10480326, 10480388, 10480411, 10480476, 10480479, 10480497, 15087020, 15087021, 15087023, 15755616W, 15768829, 25744164W, 321-1748, 321-1784, 321-1798, 321-1799, 321-1811, 321-1815, 321-1819, 321-1847, 321-1850, 321-1852, 321-1853, 321-1857

DELCO
GA1401

FEATURES / CARACTERÍSTICAS: 70A, 6x35A Avalanche Diodes, B+: 5/16" x 41mm

REPLACES / REEMPLAZA:

Delco: 10510456

APPLICATION / APLICACIÓN:

CATERPILLAR; CASE; CUMMINS; NEW HOLLAND: Tractors

ALTERNATOR / ALTERNATOR:

DELCO: 8600016, 8600017, 8600020, 8600154, 8600360;

CUMMINS: 3972735, 4936879

VOLTAGE REGULATOR:

GA714

DELCO
GA1403 // NEW //

FEATURES / CARACTERÍSTICAS: 190A, 12x50A, B+: M8x15.8mm

REPLACES / REEMPLAZA:

Cargo: 235655; **AS-Poland:** ARC1024; **Transpo:** DER1650

APPLICATION / APLICACIÓN:

MERCEDES-BENZ: E200 / E220 2.2 2000>2002, E270 / E320 2.7 2001>2002, S320 3.2 1999>2002

ALTERNATOR / ALTERNATOR:

DELCO: 10480403, 10480404, 10480407, 10480408;

MB: A0001500850, A0001501650, A0001501750, A0001502450, A0001502550

DELCO
GA1405 // NEW //

FEATURES / CARACTERÍSTICAS: 90A, Diode Avalanche, 6x50A, PS: External diameter 98.5mm, With trio diode

REPLACES / REEMPLAZA:

Cargo: 233447; **AS-Poland:** ARC1021

APPLICATION / APLICACIÓN:

DAEWOO: Lanos L4 1.5L/1.6L 1999>2002, Lanos 1.3/1.6 1997>2002, Lanos saloon 1.3/1.6 1997>2002, Leganza 2.0 16V 1997>2002, Rezzo 1.8/2.0 2000>2005

ALTERNATOR / ALTERNATOR:

DELCO: 219137, 219138, 219139, 219199, 219202, 96252115

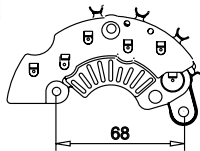
DELCO
GA1658

FEATURES / CARACTERÍSTICAS: 105A, Diodos 6x35A Avalanche (Zener), 35A Bosch type Press-fit, with capacitor

REPLACES / REEMPLAZA:

Delco: 1989658, 10456401, 10472597, DR5162; **Regitar:** RD-95A; **Cargo:** 131880; **WAI/Transpo:** DR4000;

Magneti Marelli: PR520507

APPLICATION / APLICACIÓN:

GM: Corsa 1.6, Omega CD 4.1, 2.0i, Omega Suprema 2.0i, 2.2i, Kadett 1.6, 1.8, 2.0, S10, Astra 1.8i, 2.0i, Vectra 1.8i, 2.0i, Calibra 2.0i, Cavalier III 2.0i;

DAEWOO: Espero 1.8, 2.0, 2.2

ALTERNATOR / ALTERNATOR:

DELCO: Séries CS 121 / CS 130, 10430484, 10456300, 10456301, 10456302, 10456303, 10456312, 10463001, 10463002, 10463003

VOLTAGE REGULATOR:

GA411 / GA432

DELCO
GA1707 // NEW //

FEATURES / CARACTERÍSTICAS: 120A, 6x50A Avalanche Diode, B +: M8X1.25X33mm, Outside diameter 115mm

REPLACES / REEMPLAZA:

Transpo: DR2206

APPLICATION / APLICACIÓN:

Case Skid Steer Loader: 410 Case 422T/M3 Diesel 2005>2012, 420 Case 422T/M2 Diesel 2005>2012, 420 Case 432T/M3 Diesel 2008>2012; **Cummins Engines Engine Medium Duty:** B Series 2004-2009; **Case Agricultural Tractor:** 430 Case 432T/M3 Diesel 2005>2012, 440 Case 445T/M3 Diesel 2005>2012; **Case Skid Steer Loader:** 435 Case 432T/M3 Diesel 2004>2012, 445 Case 432T/M3 Diesel 2006>2012, 450 Case 445T/M3 Diesel 2005>2012, 465 Case 445T/M3 Diesel 2005>2012; **Case Track Loader:** 420CT Case 432T/M3 Diesel 2008>2012, 440CT Case 445T/M2 Diesel 2006>2012, 440CT Case 445T/M3 Diesel 2008>2012, 445CT Case 432T/M3 Diesel 2005>2012, 450CT Case 445T/M3 Diesel 2005>2012; **New Holland Industrial Loader:** C185 3.4L 3cyl 78HP Diesel, C190 4.5L 4cyl 80HP Diesel; **New Holland Industrial Skid Steer Loader:** L180 334M2 3.4L 63HP Diesel, L185 334TM2 3.4L 78HP Turbo Dsl, L190 445M2 4.5L 80HP Diesel, LS180, LS185 334T Diesel

DELCO

GA1733 // NEW //



FEATURES / CARACTERÍSTICAS: 120A, Avalanche Diode, 6x60A, B+ M8X11.8mm, External Diameter 85mm
REPLACES / REEMPLAZA:
Mobiletron: RD-29; **Regitar:** RD-29; **Era:** 215141; **Cargo:** 231762; **Transpo:** DER2010; **AS-Poland:** ARC1003
APPLICATION / APLICACIÓN:
OPEL: Astra G box 1.6 1999>2000, Astra G convertible 1.6/1.8 2001>2005, Astra G coupe 1.8 16V 2000>2005, Astra G estate 1.4 16V 1998>2004, Astra G estate 1.6/1.8 2000>2004, Astra G hatchback 1.4/1.6/1.8/2.0 1998>2005, Astra G saloon 1.4/1.6/1.8 1998>2005, Corsa C 1.4/1.8 2000>2009, Zafira A 1.6/1.8/2.0 1999>2005
ALTERNATOR / ALTERNATOR:
DELCO: 10480225
CHEVROLET: 93175796, 93175943
OPEL: 6204073, 6204098, 6204138, 9117851, 9512784

DELCO

GA1755



FEATURES / CARACTERÍSTICAS: 140A, Avalanche Diode 3x50A, B+: M8x37 / M8x27, Ø126mm
REPLACES / REEMPLAZA:
Delco: 112M03
APPLICATION / APLICACIÓN:
GM: S10 Flex >2013; S10 Diesel >2013
ALTERNATOR / ALTERNATOR:
DELCO: 13579677
VOLTAGE REGULATOR:
 GA712

DELCO

GA1756



FEATURES / CARACTERÍSTICAS: 3X50A Avalanche, M8x35 e M8x27 B+ Parafusos, Ø112mm
REPLACES / REEMPLAZA:
Delco: A12J04
APPLICATION / APLICACIÓN:
GM: Onix, Cobalt, Spin, Prisma >2013
ALTERNATOR / ALTERNATOR:
DELCO: 94751298, 94751297
VOLTAGE REGULATOR:
 GA941

DELCO

GA1757



FEATURES / CARACTERÍSTICAS: 6X50A Avalanche
REPLACES / REEMPLAZA:
Delco: 112A06
APPLICATION / APLICACIÓN:
GM: S10 Flex >2012, S10 Diesel >2013, Sonic >2012, Cruze >2012, Tracker >2013, Trail Blazer >2014
ALTERNATOR / ALTERNATOR:
GM: 13579666, 13579677, 13579661, 13500577
VOLTAGE REGULATOR:
 GA712

DELCO

GA1758

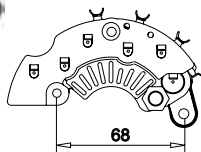

FEATURES / CARACTERÍSTICAS: 85A, Diodes 6x35A Avalanche (Zener), 35A Bosch type Press-fit, B+ Post M8, With Capacitor
REPLACES / REEMPLAZA:
Delco: 10475758; **Regitar:** RD-97B; **Cargo:** 231200; **WAI/Transpo:** DR4204; **Magneti Marelli:** PR520529
APPLICATION / APLICACIÓN:
GM: Corsa with AC., Ómega, Vectra 2.2.
ALTERNATOR / ALTERNATOR:
DELCO: Séries CS 130 D, 10463407, 10463443, 10463630, 10463654, 10463966, 10464075, 10464407, 10464409, 10464414
VOLTAGE REGULATOR:
 GA702 / GA704 / GA707 / GA711

DELCO

GA1759



FEATURES / CARACTERÍSTICAS: 85A, Diodes Avalanche (Zener) 6x35A
REPLACES / REEMPLAZA:
Delco: 10492300; **Regitar:** RD-25A; **Cargo:** 232070; **WAI/Transpo:** DR1200
APPLICATION / APLICACIÓN:
SATURN: 1998-2000 Saturn SC1, SL Sedan, SW Wagon 1.9L SOHC, DOHC
ALTERNATOR / ALTERNATOR:
DELCO: 10464477, 21022992, 21023969, 21024485, 21024486, 21024726, 21024727, 21025094, 21025339, 219214, 321-1846

DELCO
GA1941

FEATURES / CARACTERÍSTICAS: 140A, Avalanche Diodes 6x50A, B+ Bolt M6, with triodiode, with Phase terminal

REPLACES / REEMPLAZA:

Delco: 8460, 8465, 8466

APPLICATION / APLICACIÓN:

Crusader Marine, Hyster, Indmar Marine, Mercury Marine, Pleasurecraft Marine

ALTERNATOR / ALTERNATOR:

Delco: 19020604, 19020608, 19020609, 19020614, 19020615; **Mercury Marine:** 862030T

DELCO
GA1948

FEATURES / CARACTERÍSTICAS: 100A, 3x35A Avalanche diodes

REPLACES / REEMPLAZA:

...

APPLICATION / APLICACIÓN:

MERCEDEZ BENZ: Trucks LS1938, LS1938S, 1944S, LS2638, Trucks and Bus - Plataforma BR450, Trucks Accelo 915C, 712C, 914C/LO, 915E, LO915, 1318, 1618M, Trucks L1620, L1622, 1728, 2423, 2428, 1215C, L1218, 1318, L1418, 1618M, 1718M; Trucks Atego 1315, 1418, 1518, 1718, 1725, 2425; Bus 914LO, 915LO, OF1417, OF1418, OF1722 OH1418, 0500M, 0500U, 0500R; Micro-bus 814LO, Trucks Axor 2826, 2831, 1933, 2533.

VOLKSWAGEN: Constellation 13.180, 15.180, 17.250, 19.320, 24.250, 25.370, 31.320, 31.370; 8T, 9T, 13T, 15T, 16T, 17T, 18T, 23T, 24T, 26T, 31T, Volkbus 9.150 4.10, 18.310 OT

ALTERNATOR / ALTERNATOR:

...

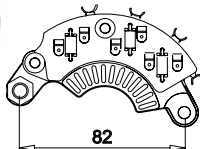
DELCO
GA1714

FEATURES / CARACTERÍSTICAS: 120A, Diodes 6x50A Avalanche (Zener), With triodiode, 50A Lucas type Press-fit, B+ Post M8

REPLACES / REEMPLAZA:

Delco: 10475034, 589714; **Regitar:** RD-04B; **Cargo:** 136595; **WAI/Transpo:** DER2000; **Magneti Marelli:** PR520519

APPLICATION / APLICACIÓN:

GM: Astra, Omega, Corsa Wind, Vectra (after 95)

ALTERNATOR / ALTERNATOR:

DELCO Séries CS 130 D: 10475039, 10479914, 10479923, 10479947, 10479955, 1217101, QX 24C3A, QX26K2, QX5L2, QX7K2

VOLTAGE REGULATOR:

GA432 / GA701

DELCO
GA1794

FEATURES / CARACTERÍSTICAS: 6x35A, Press-fit avalanche diodes

REPLACES / REEMPLAZA:

Delco: 10512368

APPLICATION / APLICACIÓN:

VW: Bus Queops Evolution with engine Cummins ISC 8,3L Diesel 9

ALTERNATOR / ALTERNATOR:

DELCO: 9600J4

DELCO
GA1795

FEATURES / CARACTERÍSTICAS: 130A, 6 X50A Avalanche Diodes

REPLACES / REEMPLAZA:

Transpo: DR2910

APPLICATION / APLICACIÓN:

CHEVROLET: Aveo L4 1.6L 1598cc 98cid 2004>2008, Aveo5 L4 1.6L 1598cc 98cid 2006>2008;

PONTIAC: Wave L4 1.6L 1598cc 98cid 2005>2008;

SUZUKI: Swift+ L4 1.6L 1598cc 98cid 2004>2008

ALTERNATOR / ALTERNATOR:

GM: 96540542, 96838439, 96954113

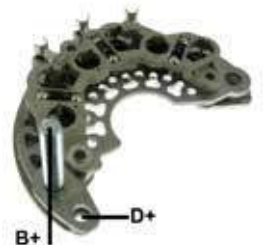
DELCO
GA1796

FEATURES / CARACTERÍSTICAS: 130A, 6 X50A Avalanche Diodes

REPLACES / REEMPLAZA:

Transpo: DR2911

APPLICATION / APLICACIÓN:

CHEVROLET: Optra L4 2.0L 1998cc 122cid 2004>2005, Optra L4 2.0L 2000cc 2006>2007, Optra L4 2.0L 2000cc 122cid 2006;

SUZUKI: Forenza L4 2.0L 2000cc 2004>2008, Reno L4 2.0L 1998cc 2005>2007, Reno L4 2.0L 1998cc 122cid 2008

ALTERNATOR / ALTERNATOR:

DELCO: 96408588;

SUZUKI: 31400-85Z00, 31400-85Z01, 31400-85Z02

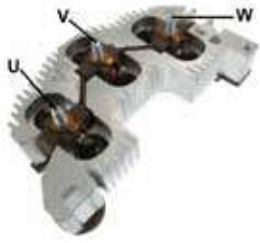
DELCO
GA1797

FEATURES / CARACTERÍSTICAS: 28V, 6x35A Press-fit avalanche diodes 70A

REPLACES / REEMPLAZA:

Delco: 1988976, 10512366

APPLICATION / APLICACIÓN:

CATERPILLAR: 16H Cat 3406 1996>1999, 966F Cat 3306 1997>1999, 980G Cat 3406 1996>2003, 824C Cat 3406 1997>1999;

JOHN DEERE: 608L, 608S 6081H Diesel, 753G 6081H Diesel, 753GL, 853G 6081H Diesel, 953G 6081H Diesel, 1058, 850, 950, EC130, EC130LC, EC160, EC160LC, EC215, EC215LC, LW170, LW230

ALTERNATOR / ALTERNATOR:

DELCO: 19010111, 19010193, 19010185, 19010182, 19010195, 19010200, 19010205, 19020307, 19020382, 19020311, 19020346, 8600277, 19011153, 19011210, 19011168, 19011175, 19011191, 19011197, 19011152, 19011173, 19011218, 19011205, 19011207

DELCO
GA1798

FEATURES / CARACTERÍSTICAS: 120A, 6x50A

REPLACES / REEMPLAZA:

Delco: 10511353; 10501634; 10469265

APPLICATION / APLICACIÓN:

Caterpillar: 35, 45 and 55 Challenger; **John Deere:** CHT2500B and CHW2500B Scania engine; **GM:** Trucks 12.170; 14.190; 15.190

ALTERNATOR / ALTERNATOR:

DELCO: 1117965; 19010112; 19010196; 19010105

VOLTAGE REGULATOR:

GA205 / GA209

DELCO
GA1799

FEATURES / CARACTERÍSTICAS: 6X60A Diodes

REPLACES / REEMPLAZA:

Delco: 10501636, 12367; **WAI/Transpo:** DR5183

APPLICATION / APLICACIÓN:

INTERNATIONAL: Trucks

ALTERNATOR / ALTERNATOR:

DELCO: 19011104

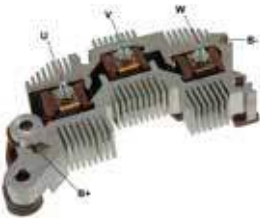
DELCO
GA1800

FEATURES / CARACTERÍSTICAS: 140A, Diodes 6x50A Avalanche (Zener)

REPLACES / REEMPLAZA:

Delco: 10475800, DR5178; **Regitar:** RD-07; **Cargo:** 232068; **WAI/Transpo:** DR5178

APPLICATION / APLICACIÓN:

GM: Ómega, Vectra.

ALTERNATOR / ALTERNATOR:

DELCO Séries CS &S: 10463169, 10463190, 10463196, 10463217, 10463295, 10463298, 10463300, 10463338, 10463343

DELCO
GA1801

FEATURES / CARACTERÍSTICAS: 120A, Diodes 6x50A Avalanche (Zener), 3x50A Button

REPLACES / REEMPLAZA:

Delco: 10467052, D3992, DR5176; **Regitar:** RD-06A; **Cargo:** 131881; **WAI/Transpo:** DR5176; **Magneti Marelli:** PR520536

APPLICATION / APLICACIÓN:

GM: Monza, Kadett;

IMPORTS: Chevy, Corvette, Buick Regal, Cadillac, Chevy Blazer.

ALTERNATOR / ALTERNATOR:

DELCO Séries CS &SI: 10459036, 10480121, 1101325, 1105656, 1105683, 1117242

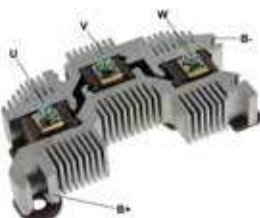
DELCO
GA1802

FEATURES / CARACTERÍSTICAS: 120A, Diodes 6x50A Avalanche (Zener)

REPLACES / REEMPLAZA:

Delco: 10470609, D3992, DR5177; **Regitar:** RD-06; **Cargo:** 231062; **WAI/Transpo:** DR5177

APPLICATION / APLICACIÓN:

GM: Monza, Kadett, Truck B6 Series, Kodiak.

ALTERNATOR / ALTERNATOR:

DELCO Séries CS &SI: 10456319, 10456336, 10459028, 10459038, 10459040, 10459047, 10459050, 10459052, 10459053, 10459054

VOLTAGE REGULATOR:

GA408

DELCO
GA1803

FEATURES / CARACTERÍSTICAS: 140A, Diodos 6x50A Avalanche (Zener)

REPLACES / REEMPLAZA:

Delco: 10472095, DR5179; **Regitar:** RD-08; **Cargo:** 232069; **WAI/Transpo:** DR5179

APPLICATION / APLICACIÓN:

GM: Ómega, Vectra, Cadillac Deville, Eldorado, Seville.

ALTERNATOR / ALTERNATOR:

DELCO Series CS & SI: 10457160, 10463191, 10463216, 10463294, 10463296, 10463377, 10464079, 10464088, 10464403, 104799821

DELCO
GA1804

FEATURES / CARACTERÍSTICAS: 85A, Diodos 6x35A

REPLACES / REEMPLAZA:

Delco: 3472813, 3493721, 3493714, 3472057, 347205758, 3472059, 3472060, 3472061, 3472062, 3472065, 3472066, 3472067, 3472068, 3472069, 3472070, 6065301; **Regitar:** RD-18; **Cargo:** 131458; **WAI/Transpo:** DER1003

APPLICATION / APLICACIÓN:

OPEL; VAUXHALL; **GM:** Corsa Wind (after 94), Astra, Vectra, Ómega 2,2 (without AC 93>95), Ómega 2.0.

ALTERNATOR / ALTERNATOR:

DELCO: 3472057, 3472058, 3472059, 3472060, 3472061, 3472062, 3472065, 3472066, 3472067, 3472068, 3472813, 1204012, 120405, 1204018, 1204020, 1204021, 1204040, 1204042, 1204043, 12041109, 1204112, 1204121, 1204203, 1204217, 1204045, 1204068, 1204014, 3493714, 3493721

DELCO
GA1805

FEATURES / CARACTERÍSTICAS: 120A, Diodos 6x50A

REPLACES / REEMPLAZA:

Delco: 3493008, 3493716, 3493717, 3472106, 3472121, 3472134, 3473234, 3473244; **Opel:** 1205454; **Regitar:** RD-20; **Cargo:** 132931; **WAI/Transpo:** DER1004

APPLICATION / APLICACIÓN:

OPEL; VAUXHALL; **GM:** Ómega 3.4

ALTERNATOR / ALTERNATOR:

DELCO: 3472106, 3472121, 3472130, 3472134, 3472137, 3472144, 3493621, 3493634, 3493641, 3493644, 3493706, 3493716, 3493717, 3493741

DELCO
GA1806

FEATURES / CARACTERÍSTICAS: 95A, Diodos 6x50A

REPLACES / REEMPLAZA:

Delco: 1987061, D3986, 1984454, D3924; **Regitar:** RD-13HV; **Cargo:** 131874; **WAI/Transpo:** DR5054

APPLICATION / APLICACIÓN:

GM: Vehicles;

JEEP;

ALTERNATOR / ALTERNATOR:

DELCO: 310497082, 1105446, 1105541, 1105617, 1101134, 1105447, 1105542, 1105629, 1101240, 1105448, 1105543, 1105630, 1101241, 1105449, 1105544, 1105648, 1101245, 1105480, 1105545, 1105654, 1101280, 1105492, 1105547, 1105444, 1101299, 1105493, 1105562, 1105445, 1101301, 1105495, 1105572, 321267, 1101302, 1105496, 1105581, 321266, 1101304, 1105505, 1105582, 1105425, 1101308, 1105506, 1105592, 1105428, 1101324, 1105507, 1105604, 321269, 1101328, 1105441, 1105606, 321268, 1101484, 1105442, 1105402, 1105443; **PIC:** 240308,240309; **LESTER:** 7294, 729412, 7830

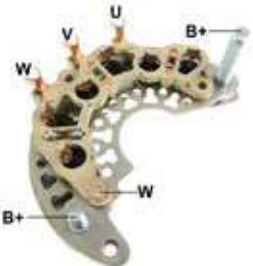
DELPHI
GA1402

FEATURES / CARACTERÍSTICAS: 115A, 6X50A Avalanche Diode, B+: M8x33mm

REPLACES / REEMPLAZA:

...

APPLICATION / APLICACIÓN:

SSANGYONG: Actyon, Actyon Sports, Kyron, Rexton 2.0, 2.7 XDI 4WD

ALTERNATOR / ALTERNATOR:

Delphi: A 664 154 0102;

Lucas Electrical: LRA03262; **Delco Remy:** DRA0712

VOLTAGE REGULATOR:

GA707

DENSO
GA1141

FEATURES / CARACTERÍSTICAS: 130A, 12x35A, Avalanche Diode, B+: M8x18mm

REPLACES / REEMPLAZA:

...

APPLICATION / APLICACIÓN:

CHEVROLET: Cruze 1.4 Turbo

ALTERNATOR / ALTERNATOR:

GM: 13587309; **DENSO:** 104211-3720

VOLTAGE REGULATOR:

GA159

DENSO

GA1142

FEATURES / CARACTERÍSTICAS: 120A, 12x35A, Avalanche Diode, B+: M8x19mm

REPLACES / REEMPLAZA:

...

APPLICATION / APLICACIÓN:

Jeep: Renegade

ALTERNATOR / ALTERNATOR:

Denso: 104211-3210

VOLTAGE REGULATOR:

GA158

DENSO

GA1143

FEATURES / CARACTERÍSTICAS: 100A, 3x35A Avalanche diodes

REPLACES / REEMPLAZA:

...

APPLICATION / APLICACIÓN:

Ford: KA 2015-2016

ALTERNATOR / ALTERNATOR:

Ford: E3B5-10300-AB, E3B5-10300-AC;

Denso: BC104210-7001, BC104210-7002

DENSO

GA1144

FEATURES / CARACTERÍSTICAS: 120A, 7x50A Bosch press-fit diode

REPLACES / REEMPLAZA:

...

APPLICATION / APLICACIÓN:

TOYOTA: Corolla Gli 1.8 16V / Xei 2.0 16V 2014>

ALTERNATOR / ALTERNATOR:

DENSO: 104210-7020; **TOYOTA:** 27060-0T320

DENSO

GA1145

FEATURES / CARACTERÍSTICAS: 130A, 12x35A Avalanche diodes

REPLACES / REEMPLAZA:

...

APPLICATION / APLICACIÓN:

HONDA: CR-V 2006>, New Civic 2012>

ALTERNATOR / ALTERNATOR:

Denso: 104210-1540, 104210-5370; **Honda:** 31100-R1P-H01

DENSO

GA1146

FEATURES / CARACTERÍSTICAS: 170A, 12x35A Avalanche Diode, B+: M8x12mm, Diameter: 133mm

REPLACES / REEMPLAZA:

...

APPLICATION / APLICACIÓN:

BMW: 228i L4 2.0L, 228i xDrive L4, 320i L4 2.0L, 320i xDrive L4, 328i L4 2.0L, 328i GT xDrive L4 2.0L, 428i L4 2.0L, 428i Gran Coupe L4 2.0L, 428i xDrive L4 2.0L, 428i xDrive Gran Coupe L4 2.0L, 528i L4 2.0L, 528i xDrive L4 2.0L, Z4 L4 2.0L

ALTERNATOR / ALTERNATOR:

BMW: 7605 473-05;

Denso: 104210-6390, 104210-6391, 104210-6392, 104210-6393, 104210-6394, 104210-6395;

Bosch: 0 986 UR6 229

VOLTAGE REGULATOR:

GA146

DENSO

GA1147

FEATURES / CARACTERÍSTICAS: 120A, 12x35A Avalanche Diode, B+: M8x12mm

REPLACES / REEMPLAZA:

...

APPLICATION / APLICACIÓN:

LAND ROVER: Discovery 4x4 3.0 TD 2009>; **RANGE ROVER:** Sport LS 3.0 D 4x4 2013>

ALTERNATOR / ALTERNATOR:

Denso: 104210-2420, DAN1105;

Land Rover: AH22-10300-AB, LR013847; **Delco:** DRA1437

VOLTAGE REGULATOR:

GA153

DENSO
GA1148

FEATURES / CARACTERÍSTICAS: 180A, 12x50A, Avalanche diode, B+: M8X12mm, Diameter: 133mm
REPLACES / REEMPLAZA:

APPLICATION / APLICACIÓN:

BMW: Series 5 / 6 / 7, 320i - 2013>, M5, X5

ALTERNATOR / ALTERNATOR:

Denso: 104210-6441

VOLTAGE REGULATOR:

GA146 / GA155

DENSO
GA1149

FEATURES / CARACTERÍSTICAS: 160A, 12x35mm Avalanche Diode, B+: M8x20mm, Diameter: 117mm
REPLACES / REEMPLAZA:

...

APPLICATION / APLICACIÓN:

CHRYSLER CAR: 200 V6 3.6L 2014, 200 V6 3.6L VIN G 2011>2013;

CHRYSLER VAN: Town & Country V6 3.6L 2011>2016;

DODGE CAR: Avenger V6 3.6L 2011>2014;

DODGE TRUCK: Journey V6 3.6L 2011>2016;

DODGE VAN: Grand Caravan V6 3.6L 2014>2016, Grand Caravan V6 3.6L VIN G 2011>2013;

LANCIA EUROPE VAN: Voyager MPV 3.6 V6 VVT 2011>2014;

RAM VAN: C/V V6 3.6L 2012>2015;

VOLKSWAGEN VAN: Routan V6 3.6L 2011>2014;

BUICK CAR: Regal L4 2.0L 2014>2015;

CHEVROLET CAR: Impala L4 2.5L 2014, Malibu L4 2.0L 2014>2015;

FIAT: 500

ALTERNATOR / ALTERNATOR:

Denso: TN421000-0770, P04801624AD, TN104210-1902, TN104210-1750, P56029582AB

GM: 13592810

VOLTAGE REGULATOR:

GA134 / GA154 / GA159

DENSO
GA1150

FEATURES / CARACTERÍSTICAS: 160A, 12x35A, B+: M8x20mm, Avalanche Diode, Diameter: 132mm

REPLACES / REEMPLAZA:

Mobiletron: RN-71

APPLICATION / APLICACIÓN:

CHRYSLER: 300 V6 3.6L 3604cc 220cid 2011>2016;

DODGE: Challenger V6 3.6L 3604cc 220cid 2015>2016, Charger V6 3.6L 3604cc 220cid 2011>2016, Durango V6 3.6L 3604cc 220cid 2011>2016;

JEEP: Grand Cherokee V6 3.6L 3604cc 220cid 2011>2015

ALTERNATOR / ALTERNATOR:

Denso: 4210007040; **Dodge:** P04801778AF

VOLTAGE REGULATOR:

GA134

DENSO
GA1151

FEATURES / CARACTERÍSTICAS: 150A, 12x35A Avalanche Diode, B+: M8x15mm

REPLACES / REEMPLAZA:

Transpo: INR437; **Regitar:** RN-39; **Mobiletron:** RN-39

APPLICATION / APLICACIÓN:

FORD: Focus C-MAX 1.8 2004>2007, Focus MK2 hatch 2.0/2.0 LPG/2.0 CNG 2004>2012, Focus MK2 Saloon 2.0 2005>2011, Focus MK2 Estate 2.0 2004>2012/2.0 LPG 2008>2011, Focus MK2 Convertible 2.0 2006>2011

ALTERNATOR / ALTERNATOR:

DENSO: 104210-5780

FORD: 3M5T-10300-XD

VOLTAGE REGULATOR:

GA159

DENSO
GA1152

FEATURES / CARACTERÍSTICAS: 130A, 12x50A, B+: M8x19.1mm, External diameter: 117mm

REPLACES / REEMPLAZA:

Denso: 021580-5891, 021580-5901; **Transpo:** INR421; **Cargo:** 235842; **Mobiletron:** RN29; **Regitar:** RN-29;

AS-Poland: ARC6021

APPLICATION / APLICACIÓN:

CHEVROLET: Cobalt L4 2.0 2005>2007; **LEXUS:** LS430 V8 4.3 2001>2003; **ACURA:** TL V6 3.2 2004, MDX V6 3.5 2003>2004; **HONDA:** Accord V6 3.0 2007; **LAND ROVER:** LR3 V6 4.0 2005>2008

ALTERNATOR / ALTERNATOR:

ACURA: 31100-RDJ-A01, CSC10; **CHEVROLET:** 22727494, 22731358, 88861823; **HONDA:** 31100-RCB-Y01, CSC50; **LAND**

ROVER: LR008862, YLE500240, YLE500240E, YLE500410; **LEXUS:** 27060-50280, 27060-50280-84

DENSO
GA1161

FEATURES / CARACTERÍSTICAS: 70A, 8x35A Diode, B+: M6X20mm

REPLACES / REEMPLAZA:

Denso: 021580-3660, 021580-3830, 021580-4030, 021580-4080, 021580-4480;

Honda: 31127-PT2-003;

Toyota: 27357-42010, 27357-50040, 27357-62040, 27357-74050, 27357-74160

APPLICATION / APLICACIÓN:

ACURA: Vigor L5 2.5 1992>1994

HONDA: Civic 1.6 19191>95

LEXUS: ES250 V6 2.5 1990>1991, ES300 V6 3.0 1992

TOYOTA: Camry L4 2.2 1992>1993, Camry V6 2.5 1989>1991, Camry V6 3.0 1992, Echo L4 1.5 2004>2005, Yaris 1.3 16V 1999>2002, Yaris 1.5 16V 2001>2010, Yaris Verso 1.3 16V 2001>2010, Solara V6 3.0 2002>2003, Paseo L4 1.5 1992, Celica L4 1.6 1990>1993, Corolla L4 1.6 1991>1992, RAV4 L4 2.0/2.4 2001>2005, Tundra V6 3.4 2003>2004, Tundra V6 4.0 2005, Prado 4.0 2004>2007, Tundra V8 4.7 2003>2006, Previa L4 2.4 1991;

SCION: xA/xB L4 1.5 2004>2006;

SUZUKI: Aerio L4 2.0 2002>2003, Aerio L4 2.3 2004;

YANMAR: 6LP-DT/DTE/DTZE/DTZE1/DTZY/ST/STE/STZE Diesel 1997>2008

ALTERNATOR / ALTERNATOR:

Denso: 100211-7860, 100211-7861, 100211-8020, 100211-8030, 100211-8070, 100211-8300, 100211-8390, 100211-8391, 100211-8392, 100211-8550, 100211-8560, 100211-8570, 100211-8600, 100211-8601, 100211-8610, 100211-8611, 100211-8640, 100211-8660, 100211-8920, 101211-2690, 101211-5700, 101211-5840, 101211-5870, 101211-9110, 101211-9130, 101211-9940, 102211-1750, 102211-1950, 102211-1951, 102211-2120, 102211-2250, 102211-2340, 102211-2690, 102211-9070, 102211-9100, 102211-9470, 104210-8000, 104210-8010, 104210-8040, 9662219-195, 9664219-800, 9760211-855, DAN1080, DAN942, DAN951, DAN959;

Acura: 31100-PV1-A01, 31100-PV1-A01RM, 31100-PV1-A02, CJP56;

Bosch: 0 986 045 831;

Honda: 31100-P14-A01, 31100-P14-A02, 31100-P14-A02RM, 31100-P30-023, 31100-P30-0230W, 31100-P30-G02, 31100-P30-G03, 31100-P30-G04, CJN40, CJP62, CJP93, CJS85, CJS88, CJU11, CJU13; **Lexus:** 27060-62040, 27060-62070;

Prestolite: 20130227;

Scion: 27060-21030, 27060-21030-84, 27060-21031, 27060-21031-84, 27060-21140, 27060-21140-84;

Suzuki: 31400-77E30;

Toyota: 27060-03010, 27060-0A090, 27060-11220, 27060-15060, 27060-16230, 27060-16230-84, 27060-16240, 27060-21030, 27060-21030-84, 27060-21031, 27060-21031-84, 27060-21140, 27060-22180, 27060-28110, 27060-2811084, 27060-31010, 27060-50300, 27060-5030084, 27060-62040, 27060-62070, 27060-62240, 27060-62240-84, 27060-72180, 27060-76010, 27060-76030;

Yanmar: 119773-77200

VOLTAGE REGULATOR:

GA166

DENSO
GA1162

FEATURES / CARACTERÍSTICAS:

REPLACES / REEMPLAZA:

Denso: 021580-4110, 021580-4610, 021580-5040, 021580-5410, 021580-6700; **Toyota:** 27357-50080, 27357-74170; **Regitar:** RN-11;

Mobiletron: RN-11; **Cargo:** 137874; **WAI/Transpo:** INR733P; **AS Poland:** ARC6062

APPLICATION / APLICACIÓN:

John Deere: 7200/7400 Diesel, 7210/7410/7510 6.78 96>01, 6081AFM01 8.1/12.5, 6125AFM01 8.1, 6125AFM01 12.5, 6081AFM75 8.1/6125AFM75 12.5/6125SFM75 12.5 04>07;

Mazda: Millenia V6 2.5 97>02, Xedos 9 2.5 V6 94>98

ALTERNATOR / ALTERNATOR:

Denso: 100211-6110, 100211-6350, 100211-6370, 100211-6390, 100211-6410, 100211-6440, 101211-7000, 101211-7070, 101211-7071, 101211-7130, 101211-7170, 101211-7180, 101211-7240, 101211-7300, 101211-7301, 101211-7570, 101211-7760, 101211-7761, 102211-0400, 102211-0830, 121000-4360, 121000-4481, 121000-4540, 9761211-718;

Acura: 31100-PR7-J01, 31100-PR7-J010M, 31100-PR7-J01RM, CLG18;

Chrysler: 04848662AB, 4642031, 4848662AB, 5104772AA, 5170746AA, 56027221AD, 56027221AD1, 56041693AC;

John Deere: RE34890, RE60745, RE65414, SE501842;

Komatsu: 600-861-1951;

Lexus: 27060-50011, 27060-50040, 27060-50070, 27060-50080, 27060-50140, 27060-50140-84, 27060-50210, 27060-50230;

Lucas: LRA03134;

Mazda: KL47-18-300, KLK1-18-300;

Toyota: 27060-0A010, 27060-66040, 27060-74180

DENSO
GA1174 // NEW //

FEATURES / CARACTERÍSTICAS: 135A, Type Diode Avalanche, B+: M8x1,25x12mm

REPLACES / REEMPLAZA:

...

APPLICATION / APLICACIÓN:

HONDA: Accord 1.5 2018, Civic 1.5 2018, CR-V 1.5 2017>2018

ALTERNATOR / ALTERNATOR:

DENSO: 104211-4340;

HONDA: 31100-5PA-A01, 31100-5PA-A01-RM, CSP71

DENSO
GA1183 // NEW //

FEATURES / CARACTERÍSTICAS: 170A, 12x50A, Type Diode Avalanche, B +: M8x1.25x13mm
REPLACES / REEMPLAZA:

...

APPLICATION / APLICACIÓN:

BMW: 335i Sedan(F30) 2012>2015, 335i GT xDrive F34 2014>2016, 335i xDrive Sedan(F30) 2013>2015, 435i Convertible(F33), Coupe(F32) 2014>2016, 435i Gran Coupe F36 2015>2016, 435i xDrive Convertible(F33), Coupe(F32) 2014>2016, 435i xDrive Gran Coupe F36 2015>2016, M235i Convertible(F23), Coupe(F22) 2014>2016, M235i xDrive Convertible(F23), Coupe(F22) 2015>2016

ALTERNATOR / ALTERNATOR:

...

DENSO
GA1256

FEATURES / CARACTERÍSTICAS: 130A, 8x35A Avalanche Diode, B+: M8X36mm
REPLACES / REEMPLAZA:

Denso: 021580-4250, 021580-4590, 021580-5570; **TRANSPO:** INR736; **REGITAR:** RN-10; **CARGO:** 233246; **MOBILETRON:** RN-10

APPLICATION / APLICACIÓN:

Hyundai: Azera 3.3/3.8 V6 2007>2011, Sonata 3.3 2006>2009, Santa Fé 3.3 V6 2007>2009, Veracruz 3.8 V6 2007>2012;

Kia: Borrego 3.8 V6 2010>2011, Sorento 3.3 V6 2007>2009

ALTERNATOR / ALTERNATOR:

DENSO: 02131-9153;

HYUNDAI: 37300-3C120

VOLTAGE REGULATOR:

GA766

DENSO
GA1257

FEATURES / CARACTERÍSTICAS: 70A, 8x50A, B+: M6x23.2mm, External diameter: 103mm
REPLACES / REEMPLAZA:

Cargo: 231236, 230671; **AS-Poland:** ARC6028; **Transpo:** INR5028; **Mobiletron:** RN-38; **Regitar:** RN-38

APPLICATION / APLICACIÓN:

ISUZU: 4BG1 1990>2007, 4BG1T 1990>2007, 4BG1TC 1990>2007, 6BG1 1988>2007, 6BG1T 1988>2007, 6BG1TC 1988>2007

JOHN DEERE: 5410 4 1998>2000, 5420 4 2001>2004, 5510 4 1998>2000, 5520 4 2001>2004, 5615F&V 0000

SUZUKI: Esteem L4 1.8 1999>2002, Sidekick L4 1.8 1997>1998

TOYOTA: Tercel L4 1.5 1998>1999

ALTERNATOR / ALTERNATOR:

ISUZU: 8-97168-246-1, 8971671570, 8971671571, 8971682460, 8971873040

JOHN DEERE: RE71763, RE72918, RE729181

SUZUKI: 31400-60G13, 31400-77E22, 31400-77E22, 31400-77E23, 31400-77E23-REM, 31400-77E24, 31400M79G00

TOYOTA: 27060-11170, 27060-78154, 27060-78154-71

DENSO
GA1259

FEATURES / CARACTERÍSTICAS: 120A, 8x50A, B+: M6x20.5mm, External Diameter: 114mm
REPLACES / REEMPLAZA:

Elccor: ARC-ND053; **Cargo:** 137671; **As-Poland:** ARC6016; **Transpo:** INR735; **Mobiletron:** RN-08; **Regitar:** RN-08

APPLICATION / APLICACIÓN:

LAND ROVER: Freelander V6 2.5 2002>2005, Freelander 2500 V6 2000>2007

LEXUS: RX300 V6 3.0 1999, LX470 V8 4.7 1998>2002

TOYOTA: Avalon V6 3.0 1998>1999, Land Cruiser V8 4.7 1999>2002, Camry V6 3.0 2002>2003

ALTERNATOR / ALTERNATOR:

LAND ROVER: YLE102480

LEXUS: 2706020110, 270602011084, 2706020140, 270602014084, 2706050260, 270605026084

TOYOTA: 27060-0A030, 27060-0A040, 27060-0A040-84, 27060-0A050, 27060-0A05084, 27060-0A070, 27060-0A070-84, 27060-17230, 27060-20090, 27060-20090-84, 27060-28100, 27060-28100-84, 27060-50260, 27060-50260-84

DENSO
GA1261

FEATURES / CARACTERÍSTICAS: 60A, 8x35A, B+: M6x22.5mm, External diameter: 114mm
REPLACES / REEMPLAZA:

Cargo: 132657; **AS-Poland:** ARC6041; **Mobiletron:** RN-41; **Regitar:** RN-41

APPLICATION / APLICACIÓN:

DAIHATSU: Fourtrak 2800 1992>2001, Rocky hard top 2.8 1987>1998, Rocky soft top 2.8 1987>1996

ALTERNATOR / ALTERNATOR:

DAIHATSU: 27030-87605, 27030-87605-000

TOYOTA: 27020-54012, 27020-54020, 27020-54021, 27020-54060, 27020-54061, 27020-54351, 27020-54354, 27020-64060, 27030-54010, 27030-54011, 27030-54012, 27030-54013, 27030-54020, 27030-54021, 27030-54022, 27030-54061, 27030-54241, 27030-54242, 27030-54243, 27030-54244, 27030-54260, 27030-54261, 27030-64030, 27030-64050, 27040-64010, 27040-64011



DENSO

GA1262



FEATURES / CARACTERÍSTICAS: 45A, 8x50A, B+: M6x19mm, External Diameter: 83mm

REPLACES / REEMPLAZA:

Cargo: 134306; **As-Poland:** ARC6004; **Transpo:** INR723; **Mobiletron:** RN-40; **Regitar:** RN-40

APPLICATION / APLICACIÓN:

BOBCAT: 320C Kubota D722B 1996>2000, 322 Kubota D722EB 2000>2006, 325 Kubota D1703B 1997>2011, 328 Kubota D1703E2B 1998>2007, 453C Kubota D750B 1994>1998, 553C Kubota D950B 1994>1997

CASE: CX27B Yanmar 3TNV82 2005>2012

NEW HOLLAND: E27B Yanmar 3TNV82A 2008>2012

JOHN DEERE: 3320 3 Cyl. 1.64 2005>2009, 3520 3 Cyl. 1.5 2005, 4310 3 Cyl. 1.50 2002>2004

DAIHATSU: Cuore 850 1985>1990, CUORE Eng.ED 10 0.8 1986>1988, HIJET Box (S85) Eng.CB41 1993>1998, SIRION (M1) Eng. EJ-DE 1.0 1998>2000

KOMATSU: FD20-11 Komatsu Diesel 1988>2007, FD20WC-11 Komatsu Diesel 1988>2007, FD30V-11 4D95L Komatsu Diesel 1990>2007

THERMO-KING: UMD 1991

TOYOTA: 3FGC-30 4Y Toyota Gas 1981>1999, 5FD-10 V1502 Engine 1986>1989, FG-10 4P / 4Y Engines 1986>2002

ALTERNATOR / ALTERNATOR:

BOBCAT: 6669618; **CASE:** VV12942377200; **DAIHATSU:** 27060-87201, 27060-87201-000, 27060-87211, 27060-87212, 27060-87212-000, 27060-87501-000; **JOHN DEERE:** AM877740, AM879908, LVA12357, RE42778, RE72915, RE729151; **KOMATSU:** 600-821-2350, 600-861-1350; **NEW HOLLAND:** SBA18504-6220, VV12942377200

THERMO-KING: 41-0749, 5D36221G01; **TOYOTA:** 27060-78001, 27060-78001-71

DENSO

GA1263

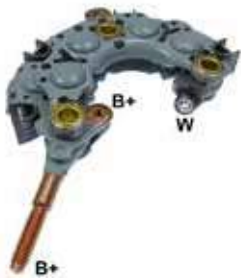

FEATURES / CARACTERÍSTICAS: 110A, 8x50A, B+: M6x20.8mm, External Diameter: 103mm

REPLACES / REEMPLAZA:

Cargo: 133672; **As-Poland:** ARC6002; **Transpo:** INR402; **Mobiletron:** RN-03; **Regitar:** RN-03

APPLICATION / APLICACIÓN:

HONDA: Acura Car CL L4 2.3 1998>1999, Odyssey L4 2.2 1995>1997

TOYOTA: Cressida L6 3.0 1989>1992, Supra L6 3.0 Turbo 1989>1992, Corolla L4 1.6/1.8 1993>1996

ISUZU: Oasis L4 2.2 1996>1997

CHEVROLET: Prizm L4 1.8 1998>2002

SUZUKI: Grand Vítara V6 2.7 2001

CATERPILLAR: 302.5C Mini Excavator 2004>2012, 303CR Mini Excavator 2001>2012

LEXUS: ES300 V6 3.0 1996

ALTERNATOR / ALTERNATOR:

CATERPILLAR: 0R4328, 0R9274, 1052813, 1052814, 1449963; **CHEVROLET:** 94853222, 94854195, 94857218; **HONDA:** 06311P2T003, 06311P2T003RM, 06311P3FJ51RM, 06311P5M003RM, 06311PAA505RM, 06311PAA506RM; **ISUZU:** 2903725850, 5862025850, 5862052600, 5862061630, 8972103730; **LEXUS:** 2706020010, 270602001084, 2706020070, 2706020120, 270602012084, 2706050250; **SUZUKI:** 3140052D00, 3140077E11, 3140077E12, 3140085D00; **TOYOTA:** 2704054300, 2704054310, 2704054391, 2704054410, 2704054440, 2704054500

DENSO

GA1264



FEATURES / CARACTERÍSTICAS: 100A, 8x50A, B+: M8x29mm, External Diameter: 114mm

REPLACES / REEMPLAZA:

Cargo: 136741; **As-Poland:** ARC6018; **Transpo:** INR739; **Mobiletron:** RN-04; **Regitar:** RN-04

APPLICATION / APLICACIÓN:

ACURA: CL V6 3.2 2001>2002, TL V6 3.2 2000>2002

HONDA: Accord 3.0 Non-Turbo 2001

HYUNDAI: Azera V6 3.8 2006>2007

JAGUAR: X-Type V6 2.5 2002>2005, X-Type V6 3.0 2002>2008, X-Type 2000 V6 2001>2005, X-Type 2500 V6 2001>2006, X-Type 3000 V6 2001>2006

TOYOTA: MR2 L4 2.0/2.2 1992>1993

VOLVO: 740 L4 2.3 1989>1990, 940 L4 2.3 1991

ALTERNATOR / ALTERNATOR:

ACURA: 06311-P8E-A21RM, 06311-PGE-506RM, 31100-P8E-A21, 31100-P8E-A21RM, 31100-P8E-A22, 31100-P8E-A22RM; **HONDA:** 06311-P8E-A21RM, 06311-PGE-506RM, 31100-P8E-A21, 31100-P8E-A21RM, 31100-P8E-A22, 31100-P8E-A22RM; **HYUNDAI:** 37300-3C150; **JAGUAR:** C2S-3710; **TOYOTA:** 27060-74330, 27060-74440, 27060-74500

VOLVO: 3544118, 3544118-7, 3544119, 3544119-0, 5003807-4, 5003808, 5003808-2

DENSO
GA1267 // NEW

FEATURES / CARACTERÍSTICAS: 60A, 8x50A, B+: M6 x 1.0 x 26.3mm

REPLACES / REEMPLAZA:

Denso: 021580-4820, 021580-5260; **Transpo:** INR734

APPLICATION / APLICACIÓN:

CHRYSLER: Daytona L4 2.2L 135cid 1989, Daytona L4 2.5L 2507cc 153cid 1989, Dynasty L4 2.5L 2507cc 153cid 1989, LeBaron L4 2.2L 135cid 1988-1989, LeBaron L4 2.5L 2507cc 153cid 1988-1989, Town & Country L4 2.2L 135cid 1988, Town & Country L4 2.5L 2507cc 153cid 1988;

DODGE: Aries L4 2.2L 135cid 1989, Aries L4 2.5L 2507cc 153cid 1988-1989, Daytona L4 2.2L 135cid 1989, Daytona L4 2.5L 2507cc 153cid 1989, Dynasty L4 2.5L 2507cc 153cid 1989, Lancer L4 2.2L 135cid 1989, Lancer L4 2.5L 2507cc 153cid 1989, Omni L4 2.2L 135cid 1988-1989, Shadow L4 2.2L 135cid 1988-1989, Shadow L4 2.5L 2507cc 153cid 1989, Spirit L4 2.5L 2507cc 153cid 1989, Caravan L4 2.5L 2507cc 153cid 1989, Grand Caravan V6 3.0L 2972cc 181cid VIN 3 1989;

PLYMOUTH: Acclaim L4 2.5L 2507cc 153cid 1989, Expo L4 2.2L 135cid 1988-1989, Horizon L4 2.2L 135cid 1989, Reliant L4 2.2L 135cid 1989, Reliant L4 2.5L 2507cc 153cid 1988-1989, Sundance L4 2.2L 135cid 1988-1989, Sundance L4 2.5L 2507cc 153cid 1989, Grand Voyager V6 3.0L 2972cc 181cid VIN 3 1989, Voyager L4 2.5L 2507cc 153cid 1989

ALTERNATOR / ALTERNATOR:

CHRYSLER: 04609230AA, 04727325AA, 04727329AA1, 05104763AA, 4609230, 4609230AA, 4671320, 4686099, 4727221, 4727329, 4727329A, 4727329AA, 5104763AA, 5104775AA, 5233599, 5233608, 5233660, 5234033, 5234199, 5234206, 5234208, 5234260, 5234374, 5234651, 53008651, 56005686, 56005686AB, 56027221, 56027221AB, 56027913, 56027913AB, 56027913AC, 56028920AA, 56028920AA1, 56041394AA, R5234208, RL104762AA, RL104763AA;

DENSO: 101211-4050, 101211-7960, 102211-3290, 102211-4050, 121000-4000, 121000-4010, 121000-4030, 121000-4040, 121000-4041, 121000-4050, 121000-4060, 121000-4070, 121000-4080, 121000-4090, 121000-4120, 121000-4122, 121000-4130, 121000-4150, 121000-4151, 121000-4160, 121000-4161, 121000-4170, 121000-4171, 121000-4210, 121000-4211, 121000-4260, 121000-4261, 121000-4270, 121000-4280, 121000-4290, 121000-4291, 121000-4300, 121000-4330, 121000-4331, 121000-4332, 121000-4333, 121000-4350, 121000-4351

DENSO
GA1268 // NEW

FEATURES / CARACTERÍSTICAS: 70A, 6x50A, B+: M6 x 1.0 x 26.0mm

REPLACES / REEMPLAZA:

Denso: 021580-4990; **Transpo:** INR502

APPLICATION / APLICACIÓN:

TOYOTA: 4Runner L4 2.7L 2694cc 1997>1999, T100 L4 2.7L 2694cc 1997>1998, Tacoma L4 2.4L 2438cc 1997>1999, Tacoma L4 2.7L 2694cc 1997>1999

ALTERNATOR / ALTERNATOR:

DENSO: 101211-0520, 101211-0521, 101211-0522, 101211-0840, 101211-4220, 102211-5020, 102211-5040, 102211-5041, 102211-5042, 102211-5050, 102211-5051, 102211-5052, 102211-5130, 102211-5131, 102211-5190, 102211-5240, 102211-5380, 102211-5650, 9761219-422; **MAGNETI MARELLI:** 063377442010; **MITSUBISHI:** A005TA6191ZC, A005TA6191ZE, A005TA6891, A005TA6891A

DENSO
GA1309

FEATURES / CARACTERÍSTICAS: 90A, 6x35A Avalanche Diode

REPLACES / REEMPLAZA:

...

APPLICATION / APLICACIÓN:

TOYOTA: Corolla 1.8 VVTI 2008>2011

ALTERNATOR / ALTERNATOR:

Denso: 27060-0D190/ 0D140, 27060-22230

VOLTAGE REGULATOR:

GA131

DENSO
GA1316

FEATURES / CARACTERÍSTICAS: 28V

REPLACES / REEMPLAZA:

Denso: 021580-6150, 021580-5350

Transpo: INR9535

APPLICATION / APLICACIÓN:

CATERPILLAR: Medium and heavy trucks

ALTERNATOR / ALTERNATOR:

DELCO: 8600127;

DENSO: 101211-8040, 101211-8050, 101211-8060, 101211-8070, 101211-8080, 101211-8090, 101211-8100, 101211-8110, 101211-8120, 101211-8130, 101211-8140, 101211-8260, 101211-8360, 101211-8380, 101211-8390, 101211-8431, 23577132, 23577133, 2887993, 1572492, 1978820, 9W3043

VOLTAGE REGULATOR:

GA448

DENSO
GA1317

FEATURES / CARACTERÍSTICAS: 6x50A Bosch press-fit diode

REPLACES / REEMPLAZA:

Denso: 0215806610; **Toyota:** 2735730070

APPLICATION / APLICACIÓN:

TOYOTA: Corolla 2008>, Camry 2008>, RAV4 2005>

ALTERNATOR / ALTERNATOR:

Denso: 1042010-5481, 104210-2802;

Toyota: 27060-37081

DENSO
GA1322

FEATURES / CARACTERÍSTICAS: 110A, 6x50A Avalanche Diode, B+: M8X34mm, Bolt B-: M5x15mm
REPLACES / REEMPLAZA:

...

APPLICATION / APLICACIÓN:

FIAT: Mobi 1.0 2014> All with A/C, Strada Work 1.4, Strada Working plus 1.4, Strada hard working 1.4, Strada work 1.4 CE/CD flex todas 2014>

ALTERNATOR / ALTERNATOR:

Denso: 101210-1601

Fiat: 51846954

VOLTAGE REGULATOR:
GA171

DENSO
GA1484 // NEW //

FEATURES / CARACTERÍSTICAS: 110A, 6x50A Avalanche Diode, B+: M8X34mm, Bolt B-: M5x15mm
REPLACES / REEMPLAZA:

Denso: 021580-5920; **Transpo:** INR425; **AS Poland:** ARC6034; **Mobiletron:** RN-44

APPLICATION / APLICACIÓN:

FORD: Thunderbird V8 3.9L 2003>2005;

LINCOLN: LS V8 3.9L 2003>2006;

CADILLAC: DeVille V8 4.6 2001>2005, Seville V8 4.6 2001>2004;

PONTIAC: Bonneville V8 4.6 2004>2005

ALTERNATOR / ALTERNATOR:

DENSO: 104210-3060, 104210-3070, 104210-3191, 104210-3201, 104210-3202, 104210-3260, 104210-3261, 104210-3280, 104210-3310, 104210-3320, 104210-4150, 104210-4360, 104210-4430, 104210-4540, 104210-4910, 104210-4990;

FORD: 3W4T-10300-AF, 3W4T-10300-AG, 3W4T-10300-AH, 3W4Z-10346-AA, 3W4Z-10346-AARM, 4W4T-10300-AA, 4W4Z-10346-AA, 6W4T-10300-AA, 6W4Z-10346-AA, 3W4T-AG, 3W4T-AH, 4W4T-AA, 6W4T-AA

DENSO
GA1486 // NEW //

FEATURES / CARACTERÍSTICAS: 136A, 12x35A Avalanche Diode, B+: M8x1.25x21.6mm

REPLACES / REEMPLAZA:

Denso: 0215805911, 0215805931; **Mobiletron:** RN-30; **Transpo:** INR420; **AS Poland:** ARC6045; **Cargo:** 333440

APPLICATION / APLICACIÓN:

CHRYSLER: 300M V6 3.5L 3497cc 215cid 2002>2004, Concorde V6 3.5L 3497cc 215cid 2002>2004, Intrepid V6 3.5L 3497cc 215cid 2002>2004;

DODGE: Intrepid V6 3.5L 3497cc 215cid 2002>2004

ALTERNATOR / ALTERNATOR:

CHRYSLER: 04606622AA, 04608826AA, 04727324AB, 04801866AB, 05037198AA, 4606622AA, 4608826AA, 4727324AB, 4801866AB, 4801866AC, 5037198AA, 56029701AA, 56029915AA, RL606622AA;

DENSO: 421000-0030, 421000-0051, 421000-0111, 421000-0113, 421000-0120, 421000-0121, 421000-0122, 421000-0180, 421000-0190, 421000-0191, 421000-0800, TN421000-0800

FORD
GA1201

FEATURES / CARACTERÍSTICAS: 95A, Diodes 8x35A, B+ Post: M6x22A, M6x22A, Ø:133 mm, with capacitor

REPLACES / REEMPLAZA:

Ford: F5AZ-10346-BA, F1TZ-10346-B, F5AZ-10304-BA; **Regitar:** RF-043; **Cargo:** 136209; **WAI/Transpo:** FR2013

APPLICATION / APLICACIÓN:

FORD: Passenger cars, Light Trucks, Aerostar 3.0L (95-97), 4.0L (92-97), Bronco 5.0L, 5.8L (93-96), E Series Van 4.2L (97-03), 5.0L, 5.8L (93-96), Escort 2.0L (98-02), Explorer 4.0L (91-00), F Series Pickup 4.2L (97-01), 5.0L, 5.8L (93-97), Ranger (92-05), 2.5L (98-02);

MAZDA: Pickup 2.3L (92-97), 2.5L (98-02), 3.0L (96-05), 4.0L w/ MT (92-01), Navajo 4.0L;

MERCURY: Tracer 2.0L (98-99)

ALTERNATOR / ALTERNATOR:

FORD: F0CZ-10346-A, F0CZ-10346-C, F0DZ-10346-A, 1160931FD, E9DF-10300-CA, F07F-10300-A, F07F-10300-AA, F07U-10300-AA, F0CF-10300-AA, F0CU-10300-AA, F0CZ-10346-A, F0CZ-10346-C, F0DZ-10346-A, F0DZ-10346-D, F0FV-10300-AA, F0VY-10346-A, F0VY-10346-B, F13U-10300-AC, F13Z-10346-A

VOLTAGE REGULATOR:

GA810 / GA890

FORD
GA1202

FEATURES / CARACTERÍSTICAS: 130A, Diodes 8x50A, B+ Post: M6x22, Ø:147 mm, with capacitor

REPLACES / REEMPLAZA:

Ford: F5AZ-10304-AA, F0DU-10A366-DAIP; **Regitar:** RF-053; **Cargo:** 136210; **WAI/Transpo:** FR2023

APPLICATION / APLICACIÓN:

FORD: Passenger cars, Light Trucks

ALTERNATOR / ALTERNATOR:

FORD: 94BB10300AE, F3AU10300BA, F5AU10300AA, 96BB10300AB, F3AU10300CA, F5PU10346CA, 97BB10300AC, F3DU10300BB, F5PU10346PA, F0DF10300BA, F4DU10300AA, F5PZ10346PA, F0DU10300BC, F4DU10300BA, F5PZ10346PARM, F0DZ10346B, F4DU10300CA, F5RU10300BA, F0DZ10346C, F4DU10300DA, F5UU10300AA, F0DZ10346E, F4PU10300AA, F5UU10300BA, F1DU10300AD, F4PU10346BA, F65U10300BB, F1DZ10346A, F4PU10346DA, F6AU10300AA

VOLTAGE REGULATOR:

GA812 / GA892

FORD
GA1203

FEATURES / CARACTERÍSTICAS: 130A, Diodes 8x50A, Ø: 133 mm, with capacitor

REPLACES / REEMPLAZA:

Ford: F6LU-10300CA, F5Z-10300FA, F6OU-10300AA, F6ZU-10300BB, F6DU-10300BB; **Regitar:** RF-063HV; **WAI/Transpo:** FR300-1

APPLICATION / APLICACIÓN:

FORD: Lincoln, Mercury

ALTERNATOR / ALTERNATOR:

FORD: A006T41491, F6LU10300CA, F77U10300AB, F50U10300FC, F6LU10300CB, F77U10300AC, F5DU10300DB, F6LU10300CC, F77Z10346AB, F5OU10300FA, F6LU10300CD, F77Z10346ABRM, F5OU10300GS, F6LU10346A, F78U10300AA, F6OU10300AA, F6LY10346A, F78Z10346AA, F6OU10300AB, F6OU10300AA, F78Z10346AARM, F60Y10346AA, F6ZU10300BB, F80U10300CA, F68U10300AD, F6ZU10300BC, F80U10300CB, F68U10300AF, F6ZU10300BE, F80Z10346CA, F68U10300AS

VOLTAGE REGULATOR:

GA813 / GA814

FORD
GA1204

FEATURES / CARACTERÍSTICAS: 105A, 8x50A Diodes 50A, Ø: 136 mm, with capacitor

REPLACES / REEMPLAZA:

Ford: F8WU10A366AAIP; **Cargo:** 230842; **Regitar:** RF-103; **WAI/Transpo:** FR600

APPLICATION / APLICACIÓN:

FORD: Windstar, Mustang

ALTERNATOR / ALTERNATOR:

FORD: 1S4110300BB, F81U10300DB, F81Z10346CA, 98AB10300FC, F81U10300DC, F81Z10346DA, 98AZ10346FA, F81U10300DD, F81U10300CC, F81Z10346EA, F81U10300BA, F81U10300EB, F81Z10346GA, F81U10300BC, F81U10300GA, XF2U10300AB, F81Z10346BA, XF2Z10346AARM, F81U10300CD, XR3Z10346AARM, XR3U10300AA, XR3Z10346AA, ZR3U10300AB, XR3U10300AB;

LESTER: 7788, 7796, 7797, 7798, 7799, 8252, 8261, 8262; **MOTORCRAFT:** GL409, GL410, GL411, GL412, GL422, GL424, GL425, GL455; **PIC:** 250283, 250401, 250402, 250403, 250404, 250405, 250416A, 250420

FORD
GA1205

FEATURES / CARACTERÍSTICAS: 105A, 8x50A Diodes 50A, Ø:136 mm, with Capacitor

REPLACES / REEMPLAZA:

Ford: F8RU10A366CAIP; **Cargo:** 233208; **Regitar:** RF-11; **WAI/Transpo:** FR601

APPLICATION / APLICACIÓN:

FORD: Contour, Mercury Cougar, Mystique

ALTERNATOR / ALTERNATOR:

FORD: 98AZ10346EA, F8AU10300AC, XS8Z10346BBRM, 98BB10300CC, F8RZ10346CC, XS9110300BB, A8ZU10300AC, XS8Z10346BB, XS9110300BC; **LESTER:** 8250; **MOTORCRAFT:** GL419, GL431; **PIC:** 250406

VOLTAGE REGULATOR:

GA846

FORD
GA1206

FEATURES / CARACTERÍSTICAS: 135A, 8x50A Diodes 50A, Ø:149 mm, with capacitor

REPLACES / REEMPLAZA:

Ford: F8AU10A366AAIP; **Cargo:** 230870; **Regitar:** RF-123; **WAI/Transpo:** FR6023

APPLICATION / APLICACIÓN:

FORD: Crown Victoria, Mercury, Lincoln Continental

ALTERNATOR / ALTERNATOR:

FORD: 3W1U10300BB, F8AZ10346AB, XF2U10300BD, 3W1Z10346BARM, F8AZ10346ABRM, XF2Z10346BA, F8AU10300AB, F8ZU10300AC, XF2Z10346BARM, XF2U10300BC; **LESTER:** 7795, 8253, 8315; **MOTORCRAFT:** GL407, GL426, GL534; **PIC:** 250293, 250400, 250408

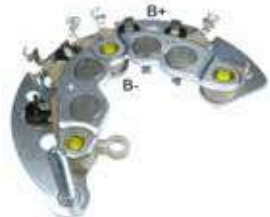
FORD
GA1207

FEATURES / CARACTERÍSTICAS: 130A, 8x50A Avalanche Diode, B+: M6x25.9mm, External Diameter: 112mm

REPLACES / REEMPLAZA:

Elccor: ARC-FO138; **Cargo:** 236658; **AS-Poland:** ARC9028; **Transpo:** FR6103

APPLICATION / APLICACIÓN:

FORD: Tourneo Connect 1.8 2002>2013, Transit Connect 1.8 2002>2013

ALTERNATOR / ALTERNATOR:

FORD: 1229421, 1429688, 1429689, 1464784, 1464785, 1465173, 1477971, 1477972, 1478187, 2T1U10300AB, 2T1U10300AC, 2T1U10300AD, 2T1U10300AE, 2T1U10300AF, 2T1U10300AG, 2T1U10300AH, 2T1U10300AK, 2T1U10300AL, 2T1U10300BB, 2T1U10300BC, 2T1U10300BD, 2T1U10300CA, 2T1U10300CB, 2T1U10300CC, 2T1U10300CD, 2T1U10300CE, 2T1U10300CF, 4362258, 4371000, 4371001, 4374447, 4374448, 4394204, 4531025, 4531026, YC1U10300EA

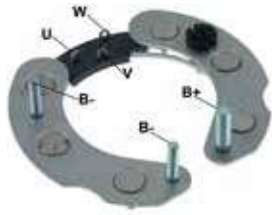
FORD
GA1210

FEATURES / CARACTERÍSTICAS: 85A, Diodes 6x35A

REPLACES / REEMPLAZA:
Ford: D6AZ10304A, D9VY-10304-A, GY-1327; **Delco:** A3900; **Cargo:** 131421; **Motorcraft:** GY1306A; **Regitar:** RF-08H;

WAI/Transpo: FR1040

APPLICATION / APLICACIÓN:
FORD: Mercury, Light Trucks

ALTERNATOR / ALTERNATOR:
FORD: D64Z10304A, GY1306A; **LESTER:** 7070, 7078; **MOTORCRAFT:** GL153, GL167A, GL209A, GL210, GL211, GL52, GL63, GL86, GL88; **PIC:** 250100, 250103, 250104, 250106, 250107, 250110

FORD
GA1211

FEATURES / CARACTERÍSTICAS: 120A, Diodes 6x50A

REPLACES / REEMPLAZA:
Ford: D2OZ10304A, F0TZ-10304-A, GY-1026-A; **Regitar:** RF-09H; **WAI/Transpo:** FR1270

APPLICATION / APLICACIÓN:
FORD: Passenger cars, Light Trucks

ALTERNATOR / ALTERNATOR:
FORD: D9AF10300CA, E3TF10300AB, E4LF10300CA, E6DF10300CA, E9TF10300AA, F0TU10300AA; **LESTER:** 7072, 70729; **MOTORCRAFT:** GL215, 250118

FORD
GA1212

FEATURES / CARACTERÍSTICAS: 85A, Diodes 6x35A

REPLACES / REEMPLAZA:
Ford: D6AZ10304A, D9VY-10304-A, GY-1327; **Delco:** A3900; **Cargo:** 131421; **Regitar:** RF-08H; **WAI/Transpo:** FR1040

APPLICATION / APLICACIÓN:
FORD: Mercury, Light Trucks

ALTERNATOR / ALTERNATOR:
FORD: D64Z10304A, GY1306A; **LESTER:** 7070, 7078; **MOTORCRAFT:** GL153, GL167A, GL209A, GL210, GL211, GL52, GL63, GL86, GL88; **PIC:** 250100, 250103, 250104, 250106, 250107, 250110

FORD
GA1213

FEATURES / CARACTERÍSTICAS: 120A, Diodes 6x50A

REPLACES / REEMPLAZA:
Ford: D4VY10304A, E2HZ10304B, F0HZ-10304-A, GY-1302-B, GY-1345-A; **Cargo:** 131430; **WAI/Transpo:** FR1280

APPLICATION / APLICACIÓN:
FORD: Passenger cars, Light Trucks

ALTERNATOR / ALTERNATOR:
FORD: D3VF-10300-AA, D3VF-10300-AB, D3VF10346-A, D3VF-10346-BA, D3VY-10346-A, D4TF-10300-DA, D4TZ-10346-A, D5OF-10300-BA, D5UF-10300-AA, D5ZF-10300-BA, D6UF-10300-AA, D7OF-10300-BA, D7UF-10300-BA, D7VF-10346-AA, D7VZ-10346-A, D7ZF-10300-BA, D7ZF-10300-CA, D8VF-10300-BA, D8VF-10346-BA, D9BF-10300-AA, D9VY-10346-D, E1BF-10300-CA, E1NF-10300-AA, E1VF-10300-AA, E1VF-10346-AA, E1VZ-10346-A, E7PF-10346-RA, E7PZ-10346-A, E7TF-10300-GA, E8DF-10300-CA, E8DZ-10300-B, E8PF-10346-BA, E8PZ-10346-B, E9DF-10300-EA, E9PF-10346-DA, E9PZ-10346-E, EZHT-10346-EB, FODU-10300-DA, FOPU-10346-RA, FOPZ-10346-C, FOUU-10300-BA, GL-108, GL-108A, GL-203, GL-203A, GL-203B, GL-256, GL-256A, GL-286

GM
GA1888

FEATURES / CARACTERÍSTICAS: 130A, 12X 35A Avalanche diodes

REPLACES / REEMPLAZA:

...

APPLICATION / APLICACIÓN:
Chevrolet: Cobalt L4 2008-2010, Malibu L4 Exc. Hybrid 2008, Malibu L4 2009-2010;

Pontiac: G5 L4 2008-2010;

Saturn: Aura L4 2008-2009, Sky L4 2008, Vue L4 2008-2010

ALTERNATOR / ALTERNATOR:

 2650532; **GM:** 15828450

VOLTAGE REGULATOR:

GA994

HITACHI
GA1748 // NEW //

FEATURES / CARACTERÍSTICAS: 110A, 8x35A, B+: M8x1.25x42.0mm

REPLACES / REEMPLAZA:
Transpo: IHR768; **AS Poland:** ARC2057; **Mobiletron:** RH-104

APPLICATION / APLICACIÓN:
ISUZU: Medium/Heavy Truck NPR L4 4.8L 290cid 2003>2006

ALTERNATOR / ALTERNATOR:
HITACHI: LR1110-501, LR1110-501B, LR1110-501BAM; **ISUZU:** 2902768400, 8972482970, 8972482971

HITACHI
GA1750 // NEW //

FEATURES / CARACTERÍSTICAS: 90A, 8x35A, B+: M6x8.5mm, External Diameter: 114mm

REPLACES / REEMPLAZA:

Cargo: 235226

APPLICATION / APLICACIÓN:

NISSAN: Almera Tino 16V 2000>2010, Almera Tino 2.0 2000>2003, Primera 2.0 16V 1999>2001, Primera hatchback 2.0 16V 1999>2002, Primera Traveller 2.0 16V 1999>2001

ALTERNATOR / ALTERNATOR:

NISSAN/ INFINITI: 23100-AN000, 23100-BU500, 23100-VC100, 23100-VC101, 23100VC10C

HITACHI
GA1751

FEATURES / CARACTERÍSTICAS: 90A, 8x35A, B+: M6x8mm, External Diameter: 114mm

REPLACES / REEMPLAZA:

Cargo: 234315; As-Poland: ARC2042; **Transpo:** IHR737; **Mobiletron:** RH-76; **Regitar:** RH-76

APPLICATION / APLICACIÓN:

NISSAN TRUCK: Pathfinder V6 3.3 1997>2000

ALTERNATOR / ALTERNATOR:

NISSAN: 23100-0W001, 23100-0W001R, 23100-0W002, 23100-0W003

HITACHI
GA1760

FEATURES / CARACTERÍSTICAS: 95A, Diodes 8x35A

REPLACES / REEMPLAZA:

Hitachi: L170G23203, L170G23202, L170G2320; **Regitar:** RH-25; **Cargo:** 135318; **WAI/Transpo:** IHR754

APPLICATION / APLICACIÓN:

CHEVROLET: Astra, Corsa, Vectra, Combo;

NISSAN: 100NX 1.6; Primera 1.6 Stationcar, Sunny 1.4i, 1.6i Stationcar

ALTERNATOR / ALTERNATOR:

HITACHI: LR170-738C

HITACHI
GA1752

FEATURES / CARACTERÍSTICAS: 60A, 8x35A, B+: M8x22mm, External diameter: 114mm

REPLACES / REEMPLAZA:

Cargo: 231442; **AS-Poland:** ARC2032; **Mobiletron:** RH-65; **Regitar:** RH-65

APPLICATION / APLICACIÓN:

JOHN DEERE: 244H Yanmar Diesel 0000, 80 0000

NISSAN: Pickup III 2.5 1998>2002, D22 Pickup 2500 1996>2001

ALTERNATOR / ALTERNATOR:

JOHN DEERE: 244H Yanmar Diesel 0000, 80 0000

NISSAN: Pickup III 2.5 1998>2002, D22 Pickup 2500 1996>2001

HITACHI
GA1754

FEATURES / CARACTERÍSTICAS: 70A, 6x35A Diode, B+: M8X45mm

REPLACES / REEMPLAZA:

Isuzu: 8-97122-644-0; **Transpo:** IHR749; **Regitar:** RH-48; **Cargo:** 230094; **Mobiletron:** RH-48

APPLICATION / APLICACIÓN:

OPEL: Astra Mk3 1.7 96>98, Corsa B 1.5/1.7 96>00, Corsa B Box 99>00, Vectra B 1.7 95>96, Astra Van 1.7 96>98, Corsa/Combo 1.7 96>01;

VAUXHALL: Vectra B/Vectra B Hatchback 95>96

ALTERNATOR / ALTERNATOR:

HITACHI: LR170-505, LR170-505B

VOLTAGE REGULATOR:

GA251

HITACHI
GA1761

FEATURES / CARACTERÍSTICAS: 95A, Diodes 8x35A, with diode trio

REPLACES / REEMPLAZA:

Hitachi: L165G1320, L170G1320, L190G13201; **Regitar:** RH-26; **Cargo:** 136976; **WAI/Transpo:** IHR755

APPLICATION / APLICACIÓN:

NISSAN: 100NX 1.6, Primera 1.6 Stationcar, Sunny 1.4i, 1.6i Stationcar;

MAZDA: 121 1.1, 1.3i, 1.4i

ALTERNATOR / ALTERNATOR:

HITACHI: LR160725, LR160725B, LR160726, LR160738, LR170738B; **LESTER:** 13334, 13564, 13642, 14960; **NISSAN:** 2310050Y09;

PIC: 204341A, 204354A, 204365, 204367

HITACHI
GA1762

FEATURES / CARACTERÍSTICAS: 85A, Diodes 6x35A, with diode trio, Ø:103 mm

REPLACES / REEMPLAZA:

Hitachi: L170G1320; **Regitar:** RH-26; **Cargo:** 136976; **WAI/Transpo:** IHR755

APPLICATION / APLICACIÓN:

NISSAN: 100NX 1.6, Primera 1.6 Stationcar, Sunny 1.4i, 1.6i Stationcar;

MAZDA: 121 1.1, 1.3i, 1.4i;

HONDA;

ISUZU

ALTERNATOR / ALTERNATOR:

HITACHI: LR150-711

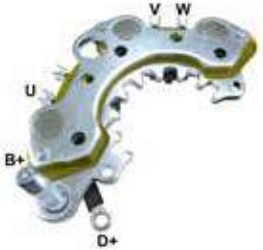
HITACHI
GA1763

FEATURES / CARACTERÍSTICAS: 90A, 6x35A, B+: M6x8mm, with Diode Trio

REPLACES / REEMPLAZA:

...

APPLICATION / APLICACIÓN:

ASIA MOTORS: Towner, Effa, Hafei, Chana

ALTERNATOR / ALTERNATOR:

HITACHI: 1105 02312 498

HITACHI
GA1764

FEATURES / CARACTERÍSTICAS: 95A, Diodes 8x35A, Ø 103mm

REPLACES / REEMPLAZA:

Hitachi: L170-33202; **Subaru:** 23830-AA-040; **Cargo:** 135038; **Regitar:** RH-21; **WAI/Transpo:** IHR750

APPLICATION / APLICACIÓN:

Subaru: Legacy 1.6, 1.8, 2.0, 16V, 2.2

ALTERNATOR / ALTERNATOR:

HITACHI: LR170732B, LR170732C; **LESTER:** 13275; **PIC:** 204347, 23700AA090

HITACHI
GA1765

FEATURES / CARACTERÍSTICAS: 95A, Diodes 6x35A, Ø 103mm, with diode trio

REPLACES / REEMPLAZA:

Hitachi: L170-43202; **Subaru:** 23830-12G01; **Cargo:** 136650; **Regitar:** RH-22; **WAI/Transpo:** IHR751

APPLICATION / APLICACIÓN:

NISSAN: Pick-up, Pathfinder, Terrano 13.0 V6

ALTERNATOR / ALTERNATOR:

HITACHI: LR170734, LR170734B, LR170739, LR170739B, LR180729; **LESTER:** 13285, 13533; **NISSAN:** 2310012G02, 2310088G00;

PIC: 204344A, 204346, 204352, 204352A

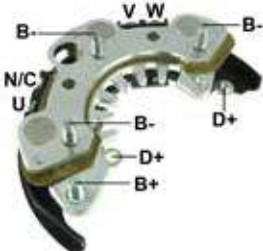
HITACHI
GA1766

FEATURES / CARACTERÍSTICAS: 85A 6x35A press-fit diodes, M5x8mm Battery Post, Outside diameter: 103mm With Trio

REPLACES / REEMPLAZA:

Hitachi: L18013202; **NISSAN:** 2323064LJ00

APPLICATION / APLICACIÓN:

NISSAN: Pick up, Pathfinder;

SUBARU: Legacy

ALTERNATOR / ALTERNATOR:

Hitachi: LR160-723, LR160-723B, LR160724, LR180-725; **Nissan:** 23100-64J00, 23100-80G08, 23100-80G09; **AC Delco:** 334-1944

HITACHI
GA1768

FEATURES / CARACTERÍSTICAS: 120A, Diodes 6x50A, Ø 103mm

REPLACES / REEMPLAZA:

Hitachi: L180G-7320; **Regitar:** RH-29; **Cargo:** 135039; **WAI/Transpo:** IHR758

APPLICATION / APLICACIÓN:

NISSAN: Altima, Axxess

ALTERNATOR / ALTERNATOR:

NISSAN: LR180725b, LR180725C, LR180736B

HITACHI
GA1770

FEATURES / CARACTERÍSTICAS: 95A, DIODES 8x35A, without diode trio, B+ POST M5x8mm, terminal W
REPLACES / REEMPLAZA:
Hitachi: L170-23203, L170G-23203; **Nissan:** 23230-50Y06;
APPLICATION / APLICACIÓN:
NISSAN: 1991 Nissan
ALTERNATOR / ALTERNATOR:
HITACHI: LR170-738B, LR170-738; **NISSAN:** 23100-50Y06, 23100-50Y09;

HITACHI
GA1771

FEATURES / CARACTERÍSTICAS: 85A, DIODES 6x35A, with diode trio, B+ POST M5x8mm, Terminal D+
REPLACES / REEMPLAZA:
Hitachi: L160-73203, L180-13202; **Nissan:** 23230-64J00, 23230-80G08;
APPLICATION / APLICACIÓN:
NISSAN: INFINITI 90>93
ALTERNATOR / ALTERNATOR:
HITACHI: 2310064J00

HITACHI
GA1772

FEATURES / CARACTERÍSTICAS: 95A, DIODES 8x35A, without diode trio, B+ POST M8x45mm, Terminal W
REPLACES / REEMPLAZA:
Hitachi: GD109578B, L170G-13201, L190G-43203; **Nissan:** 23230-0M000, 23230-0W000
APPLICATION / APLICACIÓN:
NISSAN: 1997-95 Nissan
ALTERNATOR / ALTERNATOR:
Hitachi: GD109578B, L170G-13201, L190G-43203; **Nissan:** 23230-0M000, 23230-0W000; **Cargo:** 138732

HITACHI
GA1773

FEATURES / CARACTERÍSTICAS: 85A, DIODES 6x35A Avalanche, without diode trio, Terminal W
REPLACES / REEMPLAZA:
Hitachi: GD214675G; **Nissan:** 23100-1E800, 23230-0M800;
APPLICATION / APLICACIÓN:
NISSAN: 1999 - 95, Nissan lift Truck
ALTERNATOR / ALTERNATOR:
HITACHI: LR180-744, LR180-741H; **NISSAN:** 23100-1E800

HITACHI
GA1774

FEATURES / CARACTERÍSTICAS: 95A, DIODES 8x35A Avalanche, without diode trio, Terminal W
REPLACES / REEMPLAZA:
WAI/Transpo: 1HR739; **Regitar:** RH-69
APPLICATION / APLICACIÓN:
NISSAN: 98>01
ALTERNATOR / ALTERNATOR:
HITACHI: LR1100-722, LR170-709B; **NISSAN:** 23100-9E000, 23100-5M000;

HITACHI
GA1775

FEATURES / CARACTERÍSTICAS: 95A, DIODES 8x35A Avalanche, without diode trio, Terminal W
REPLACES / REEMPLAZA:
Hitachi: L185G-1320, L190G-33204; **Subaru:** 23830-AA080, 23830-AA100, 23830-AA140;
APPLICATION / APLICACIÓN:
SUBARU: 1995
ALTERNATOR / ALTERNATOR:
HITACHI: LR185-702, LR185-701C, LR185-701;

HITACHI
GA1776

FEATURES / CARACTERÍSTICAS: 95A, DIODES 8x35A Avalanche, without diode trio, Terminal W

REPLACES / REEMPLAZA:

Hitachi: GD213418K, L1110G-4320, L1125G-2320, L1125G-7320; **Isuzu:** 84252700; **Nissan:** 23230-31U01, 23230-31U08, 23230-31U09, 23230-40U00;

APPLICATION / APLICACIÓN:

NISSAN; INFINITI: 99-95

ALTERNATOR / ALTERNATOR:

HITACHI: LR1125-702B, LR1110-705; **NISSAN:** 23100-31U02, 23100-31U01;

HITACHI
GA1777

FEATURES / CARACTERÍSTICAS: 85A, DIODES 6x35A, without diode trio, B+ Post M8x45mm, Terminals W

REPLACES / REEMPLAZA:

WAI/Transpo: 1HR745; **Regitar:** RH-30; **Cargo:** 138732

APPLICATION / APLICACIÓN:

NISSAN: 1999-97

ALTERNATOR / ALTERNATOR:

HITACHI: LR170-745;

HITACHI
GA1778

FEATURES / CARACTERÍSTICAS: 70A, 6x35A, B+: M5x12.2mm, External diameter: 118mm

REPLACES / REEMPLAZA:

Elccor: ARC-HI056; **Cargo:** 131598; **AS-Poland:** ARC2001; **Transpo:** IHR603; **Mobiletron:** RH-01; **Regitar:** RH-01

APPLICATION / APLICACIÓN:

NISSAN: 200SX 2.0 1984>1986, Stanza 2.0 1982>1983, Prairie

SUBARU: GL H4 1.6L 1595 1986>1987, GL H4 1.8 1982>1984, Standard H4 1.6 1985>1987

ALTERNATOR / ALTERNATOR:

ISUZU: 8970959640

NISSAN: 23100-01D00, 23100-01N13, 23100-04M10, 23100-06S10, 23100-17C00, 23100-17C00R

SUBARU: 42990-7320, 42990-7330, 42990-7340, 42990-7400, 42990-7500, 42990-7700, 72990-7500

HITACHI
GA1780

FEATURES / CARACTERÍSTICAS: 120A, 6x50A Hitachi Press-fit diodes, 100mm OD, M6 x 1.0 x 44mm Batt. Term.

REPLACES / REEMPLAZA:

Hitachi: L170-9320; **Nissan:** 23230-51S00; **Regitar:** RH-39C; **Cargo:** 132098; **WAI/Transpo:** IHR719

APPLICATION / APLICACIÓN:

NISSAN: 16V 86-88, Sentra, Sunny.

ALTERNATOR / ALTERNATOR:

HITACHI: 70A IR/IF Alternators

HITACHI
GA1781

FEATURES / CARACTERÍSTICAS: 120A, 6x50A Hitachi Press-fit diodes, 118mm OD / with diode trio

REPLACES / REEMPLAZA:

Hitachi: L160-23202; **Regitar:** RH-15; **Cargo:** 135037; **WAI/Transpo:** IHR721

APPLICATION / APLICACIÓN:

NISSAN: Diesel (1986 - 87);

ISUZU: Truck, NPR, Hino

ALTERNATOR / ALTERNATOR:

HITACHI: 60-70A IR/EF Alternators, LR170-404, LR170-406B, LR170-402, LR160-422B

HITACHI
GA1782

FEATURES / CARACTERÍSTICAS: 85A, 6x35A Hitachi Press-fit diodes, 100mm OD / with diode trio

REPLACES / REEMPLAZA:

Hitachi: L140-53201; **Isuzu:** 8942469571, 8942469570, 5812180330

APPLICATION / APLICACIÓN:

ISUZU: Pickup L4 2.2L Diesel 1981

CHEVROLET: Luv L4 2.2L Diesel 1981>1982

ALTERNATOR / ALTERNATOR:

Hitachi: LR140-112, LR140-131, LR140-131B, LR140-138

Isuzu: 8942214514, 8942469570, 8942469571

GM: 94246957

HITACHI
GA1783

FEATURES / CARACTERÍSTICAS: 85A, 6x35A Hitachi Press-fit diodes, 100mm OD, M5x0.8x26.88mm Batt. Term. / with diode trio
REPLACES / REEMPLAZA:
Hitachi: L135-13208
APPLICATION / APLICACIÓN:
NISSAN; DATSUN
ALTERNATOR / ALTERNATOR:
HITACHI: 20-35A IR/EF Alternators

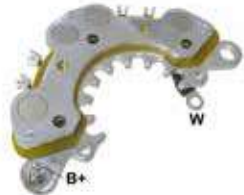
HITACHI
GA1784

FEATURES / CARACTERÍSTICAS: 95A, 6x35A
REPLACES / REEMPLAZA:
Nissan: Infiniti 23230-3S501
APPLICATION / APLICACIÓN:
NISSAN: D-21 2000
ALTERNATOR / ALTERNATOR:
HITACHI: 70A IR/IF Alternators

HITACHI
GA1785



FEATURES / CARACTERÍSTICAS: 55A, 6 X 35A Avalanche diodes
REPLACES / REEMPLAZA:
IHR604; Regitar: RH-02, RH-02C; **Cargo:** 131599; **WAI/Transpo:** IHR604, IHR604HD
APPLICATION / APLICACIÓN:
Chevrolet: LUV, Caprice, Malibu
Isuzu: Pickup
Nissan: 720
ALTERNATOR / ALTERNATOR:
Hitachi: LR140-130B

HITACHI
GA1786

FEATURES / CARACTERÍSTICAS: 60A, 6 X 35A
REPLACES / REEMPLAZA:
Hitachi: L14013202, L14053202; **Regitar:** RH-04, RH-04C, RH-50; **Cargo:** 131603; **WAI/Transpo:** IHR723, IHR723HD, IHR1002
APPLICATION / APLICACIÓN:
Nissan: Diesel Europe
ALTERNATOR / ALTERNATOR:
Hitachi: LR140-130P, LR140402

HITACHI
GA1787

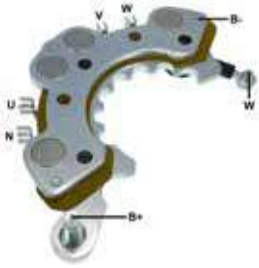
FEATURES / CARACTERÍSTICAS: 60A, 6x35A
REPLACES / REEMPLAZA:
Hitachi: L150-13206, L160-6320; **Regitar:** RH-03, RH-03C, RH-10C; **Cargo:** 131600; **WAI/Transpo:** IHR710, IHR710HD, IHR722
APPLICATION / APLICACIÓN:
Nissan: F10, Pathfinder; Subaru: DL, GL, RX.
ALTERNATOR / ALTERNATOR:
Hitachi: GD105700-D, GD207976-A, LR150-125, LR150-125B, LR150-163, LR150-165, LR150-177, LR150-94B, LR150-98, LR150-98B, LR150-99, LR150-99B, LR155-23, LR155-25, LR160-121, LR160-124, LR160-137, LR160-138, LR160-166, LR160-36, LR160-78, LR160-78B, LR160-78C, LR165-03, LR235-65P, LR235-65S, LR235-69; **Hyster:** 1360815, 3068340, 3122810; **Isuzu:** 5812003470; **Nissan:** 23100-04M00, 23100-10W00, 23100-10W01, 23100-37M00, 23100-95013, 23100-95013X, 23100-M5960, 23100-M5961, 23100-M6600, 23100-M6601, 23100-N8500, 23100-W5802, 23100-W5803, 23100-W5805, 23100-W5806, 23100-W5807, 23100-Z5560; **Subaru:** 23700-AA000, 23700-AA020, 23700-AA160, 42990-7600, 42990-7800; **Valeo:** 436505, 436506, 436518, 436551

HITACHI
GA1788

FEATURES / CARACTERÍSTICAS: 80A, 8x35A

REPLACES / REEMPLAZA:
WAI/Transpo: IHR783

APPLICATION / APLICACIÓN:
Chevrolet: W3500, W4500, W5500 (Tiltmaster); GMC: W3500, W4500, W5500 (Forward); Isuzu: NPR L4, NQR L4

ALTERNATOR / ALTERNATOR:
GM: 97116697, 97189650;

Hitachi: LR180-509, LR180-509C, LR180-509R;

Isuzu: 2-90276-810-0, 8971166973, 8971896500

HITACHI
GA1789

FEATURES / CARACTERÍSTICAS: 35A, 6x35A

REPLACES / REEMPLAZA:
GM: 94021546, 94024356; **Hitachi:** L125-6320, L125-8320, L140-24356, L140-6320, L140-7320, L140-9320, L160-13201; **Iseki:** 658-1218-021-0; **Isuzu:** 5-81218-0010, 5-81218-0210, 5-81218-0220, 9-82231-6190; **Lucas Industries:** 36511042, 36511050, UB.J102X, UB.J107X; **Nissan Infiniti:** 23230-H0300, 23230-U0100, 23232-B8000, 23232-E6200, 23232-E6601, 23232-H6200, 23232-N3300, 23232-U0102; **Subaru:** 3144100808, 395342501, 89534-6111, 895346101; **Yanmar:** X-L1258320, X-L125832000; **Regitar:** RH-49;

Cargo: 130618; **WAI/Transpo:** IHR1000, IHR1000HD

APPLICATION / APLICACIÓN:
Chevrolet: 1972>1980; **Ford:** 1973>1983; **New Holland:** 1973>1983; **Nissan:** 1969>2005; **Nissan - Europe:** 1977>1982;

Subaru: 1972-1974; **Yanmar:** 1975>1990.

ALTERNATOR / ALTERNATOR:
DELCO: 94207358; **FORD:** SBA18504-6071; **GM:** 94021045, 94023539, 94024347, 94024348, 94206081; **HITACHI:** GB108614-A, GD102423-A, LT110-04, LT115-52, LT120-05, LT120-07, LT123-16, LT125-06, LT125-06B, LT130-37K, LT130-72, LT130-72B, LT130-75, LT130-81, LT130-83, LT130-89, LT133-04, LT133-05, LT135-13, LT135-138, LT135-13B, LT135-13C, LT135-14, LT135-16, LT135-17, LT135-19, LT135-19B, LT135-19C, LT135-19E, LT135-20, LT135-22, LT135-24, LT135-24B, LT135-26, LT135-27, LT135-30, LT135-35, LT135-35B, LT135-35C, LT135-36, LT135-36B, LT135-36C, LT135-68, LT135-69, LT135-69B, LT135-69BR, LT135-73, LT135-73B, LT135-73BR, LT138-02, LT140-135, LT140-80, LT140-87B, LT140-90, LT140-95, LT150-03, LT150-05, LT150-05B, LT150-10, LT150-10B, LT150-12, LT150-13B, LT150-16, LT150-17, LT150-21, LT150-22, LT150-22B, LT150-23, LT150-23B, LT150-24, LT150-24B, LT150-25B, LT150-26B, LT150-46, LT150-47, LT150-47B, LT150-57E, LT160-10, LT160-13, LT160-16, LT160-17, LT160-19, LT160-19B, LT160-20, LT160-20B, LT160-23, LT160-23B, LT160-23C, LT160-23E, LT160-24, LT160-24B, LT160-24C, LT160-24E, LT160-28, LT160-28B, LT160-28E, LT160-34, LT160-34B, LT160-35, LT160-45; **HYSTER:** 3004578; **ISHIKAWAJIMA:** 18504-6070, 18504-6071; **ISUZU:** 5812000530, 5812000840, 5812000860, 5812001140, 8941271840, 8942060810, 8942073580, 9-82200-763-0, 9822007640; **mitsubishi:** AG2050N1, AG2050N11, AG2050N16, AG2050N24, AG2050N4, AG2050N6; **NEW HOLLAND:** SBA18504-6071; **NISSAN/INFINITI:** 23099-V0604, 23100-61700, 23100-80210, 23100-80215, 23100-90060, 23100-A4601, 23100-A4602, 23100-A5500, 23100-A5501, 23100-B8001, 23100-B8002, 23100-C6000, 23100-H0300, 23100-H6200, 23100-H6201, 23100-H6202, 23100-H6203, 23100-H7200, 23100-L1802, 23100-M0400, 23100-M0401, 23100-M0402, 23100-M0403, 23100-M6900, 23100-N3300, 23100-N3301, 23100-N3302, 23100-N3303, 23100-P0100, 23100-P0101, 23100-P0102, 23100-P0103, 23100-P0110, 23100-P0111, 23100-P0112, 23100-P0113, 23100-P4500, 23100-P4501, 23100-P4502, 23100-U0100, 23100-U0101, 23100-U0102, 23100-U0103, 23100-U0104, 23100-U0105, 23100-U0110, 23100-U0500, 23100-U0501, 23100-U0502, 23100-U0503, 23100-U0504, 23100-U0505, 23100-U0701, 23100-U0702, 23100-U0703, 23100-U0704, 23100-U5800, 23100-U5801, 23100-U5802, 23100-U5803, 23100-U6000, 23100-U6001, 23100-U6002, 23100-U6003, 23100-U6100, 23100-U6101, 23100-U6103, 23100-U6500, 23100-U6501, 23100-U6502, 23100-U6503, 23100-U6504, 23100-U6505, 23100-U0502; **SUBARU:** 23990-0100, 32990-0100, 32990-5300, 82990-6100, 82990-6110, 82990-7600; **VALEO:** 436502, 437149; **YALE:** 2200073-94; **YANMAR:** 124560-77200, 124756-77210

HITACHI
GA1790

FEATURES / CARACTERÍSTICAS: 110A, 8x35A Avalanche Diodes

REPLACES / REEMPLAZA:
WAI/Transpo: IHR769; **Regitar:** RH-68; **Cargo:** 235729; **Mobiletron:** RH-73

APPLICATION / APLICACIÓN:
Honda: Civic 1700, MKVII;

Opel: Vectra, Astra G, Combo C, Corsa C, D, Meriva A, Astra Van G, Corsa/Combo I; Vauxhall: Astra G, Corsa C, Astravan G

ALTERNATOR / ALTERNATOR:
GM: 93175799, 97189113;

Hitachi: LR1100-502, LR1100-502E, LR1100-502F, LR1100-502G, LR1100-502H, LR1100-502J, LR1100-502K, LR1100-502MD, LR1100-504B, LR1100-504E;

Isuzu: 8-97189-113-0, 8-97189-113-3, 8-97189-113-4, 8-97189-113-5, 8-97189-113-6, 8-97189-113-7, 8-97369-507-0, 89711891133, 89711891134, 89711891135, 89711891136, 89711891137;

Opel: 12-04-158, 6204183, 93175944, 9512785, 97-189-113, 97326180;

Valeo Tech: 584373;

Vauxhall: R1530037

HITACHI
GA1791

FEATURES / CARACTERÍSTICAS: 80A, 8x35A Diode

REPLACES / REEMPLAZA:
Hitachi: L150-53203, L165-6320, L165-7320, L170-6320, L180-33201; **Isuzu:** 8-94462-853-0; **Nissan/ Infiniti:** 23230-30R00, 23230-30R60, 23230-58S00, 23230-77A00, 23230-D4400; **Subaru:** 23830-AA020; **Transpo:** IHR720; **AS-Poland:** ARC2048;

Mobiletron: RH-40C; **Regitar:** RH-40C

APPLICATION / APLICACIÓN:
ISUZU TRUCK: Amigo 2.3/2.6, Pickup 2.3/2.6, Rodeo 2.6, Trooper 2.3/2.6;

NISSAN: 240SX 2.4, Axxess 2.4, Stanza 2.0/2.4, Pulsar NX 1.6/1.8, Sentra 1.6, Sunny 1.6

ALTERNATOR / ALTERNADOR:
HITACHI: LR150-704, LR150-704H, LR160-715, LR160-718, LR160-718H, LR165-704B, LR165-707, LR165-707B, LR165-708, LR165-715B, LR165-716, LR165-716B, LR165-717, LR170-714, LR170-715, LR170-715B, LR170-716, LR170-716B, LR170-727, LR170-727R, LR180-715, LR180-719; **ISUZU:** 23700AA150, 2912769200, 2912769300, 2912769320, 8943367300, 8943367310, 8944367300, 8944492650, 8944492660; **NISSAN/ INFINITI:** 23100-30R00, 23100-30R00R, 23100-30R60, 23100-30R60R, 23100-53A00, 23100-58S00, 23100-70A00, 23100-70A00-R, 23100-70A00R, 23100-70A00R, 23100-77A00, 23100-77A00R, 23100-D4400, 23100-D4400R, 23100-D4405, 23100-D4405R; **SUBARU:** 23700-AA150; **VALEO:** 436545, TA000B43001Z

HITACHI
GA1792 // NEW //

FEATURES / CARACTERÍSTICAS: 100A, Avalanche Diode, B+: M5x0.8x19.4mm

REPLACES / REEMPLAZA:
Hitachi: L1100G-5320; **Elccor:** ARC-HI128; **Cargo:** 231081; **AS-Poland:** ARC2028; **Mobiletron:** RH-63; **Regitar:** RH-63

APPLICATION / APLICACIÓN:
Opel: Astra Mk3 1.7 1996>1998, Vectra B 1.7 1995>1996;

Vauxhall: Vectra B 1.7 1995>1996, Vectra B Hatchback 1.7 1995>1996

ALTERNATOR / ALTERNADOR:
HITACHI: LR1100-501B

HITACHI
GA1793 // NEW //

FEATURES / CARACTERÍSTICAS: 70A, 6x35A Diode, B+: M6X37.5mm, External Diameter 118mm

REPLACES / REEMPLAZA:
Cargo: 138617; **AS-Poland:** ARC2027; **Mobiletron:** RH-60; **Regitar:** RH-60

APPLICATION / APLICACIÓN:
NISSAN: Pick-Up II 2.5 1987>1998, Terrano II 2.7 1989>1996, Urvan Box 2.3/2.5 1988>1997

ALTERNATOR / ALTERNADOR:
HITACHI: LR170-502C, LR190-505E, LR190-511, LR190-511B

NISSAN: 23100-86N00, 23100-86N01

INDIEL
GA1939

FEATURES / CARACTERÍSTICAS: 65A, Diodos 6x35A, 115mm

REPLACES / REEMPLAZA:
Indiel: 35213939, K03939

APPLICATION / APLICACIÓN:
GM: D20, Silverado; **Ford:** Escort, Verona, with motor AP 1.6, 1.8, 2.0 **VW:** GOL, PARATI, SAVEIRO, POINTER with motor AP 1.6, 1.8, 2.0, Gol Diesel 1.6; **MBB:** MB 180D

ALTERNADOR:
INDIEL: 35213795, 35213940, 35214040, 35214325, 35214405

VOLTAGE REGULATOR:

GA720

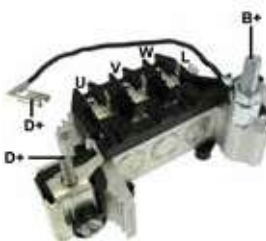
ISKRA
GA1328

FEATURES / CARACTERÍSTICAS: 55A, 6 X 35A Avalanche Diodes

REPLACES / REEMPLAZA:
LETRIKA: 16.907.902, 6230931M91;

ISKRA: 16.907.902, 6230931M91

APPLICATION / APLICACIÓN:
MASSEY FERGUSON: MF200, MF250, MF255, MF262, MF275, MF283, MF290, MF291, MF400, MF415, MF4200, MF425, MF4265, MF4275, MF4283, MF4290, MF4291, MF4292, MF435, MF440, MF445, MF450, MF455, MF460, MF465, MF5300, MF5320, MF5200, MX720, MX750

ALTERNATOR / ALTERNADOR:
ISKRA: 11203130, 11203131, 11203634, 11203635, 11203636, 11203783, 11203784, 11203785, 11203786, 11203787, 11203841, 11204055, 11204082, 11204101, 11204111, 11204112, 11204113, 11204114, 11204124, 11204458, 11204609, 11204610, 11204615, 11204616, 11204617, 11204618, 11204619, 11204695

VOLTAGE REGULATOR:

GA407

ISKRA

GA1329

FEATURES / CARACTERÍSTICAS: 120A , 8x50A Avalanche Diodes
REPLACES / REEMPLAZA:
ISKRA: 16907048
APPLICATION / APLICACIÓN:
Valtra: BM, BH;
Massey Ferguson: MF6360;
New Holland: TC57, 5090
ALTERNATOR / ALTERNATOR:
Iskra: 11203540 / 11204311

ISKRA

GA1330

FEATURES / CARACTERÍSTICAS: 95A, 8x35A Avalanche Diodes, B+ Bolt M8, D+ Bolt M5, with diode trio and capacitor
REPLACES / REEMPLAZA:
ISKRA: 16903314; **Cargo:** 231050
APPLICATION / APLICACIÓN:
Lada: Niva 1.7 1995>1997
ALTERNATOR / ALTERNATOR:
ISKRA: 11201498, AAK5102, AAK5105

ISKRA

GA1331

FEATURES / CARACTERÍSTICAS: 135A, 8x50A Avalanche Diode (Zener), with diode trio
REPLACES / REEMPLAZA:
Iskra: 16903507; **Cargo:** 231472
APPLICATION / APLICACIÓN:
 Tractors
ALTERNATOR / ALTERNATOR:
ISKRA: 11201666, AAK5115, 11201597, AAK5114, 11201758, 11201675, AAK5132, 11201667, AAK5118;

JAC

GA1673 // NEW //

FEATURES / CARACTERÍSTICAS: 110A, 6x50A Avalanche Diode (Zener), B + : M8x1.25x12mm
REPLACES / REEMPLAZA:
 ...
APPLICATION / APLICACIÓN:
JAC: T6
ALTERNATOR / ALTERNATOR:
JAC: 1015301GD173
VOLTAGE REGULATOR:
 GA673

JHECO

GA1388

FEATURES / CARACTERÍSTICAS: 85A, Diodes Avalanche 6x35A , M8x55 B+ Paraf., 80mm Distance between holes, with capacitor
REPLACES / REEMPLAZA:
Jheco: J11D19
APPLICATION / APLICACIÓN:
JAC: J3 Turin, J3 Hatch, J2 2010>
ALTERNATOR / ALTERNATOR:
JHECO: JFZ1929L, 1025100GG010, L21580
VOLTAGE REGULATOR:
 GA806

LEECE NEVILLE

GA1600

FEATURES / CARACTERÍSTICAS: 150A, Diodes 3x50A, Plate Positive
REPLACES / REEMPLAZA:
Mobiletron: RC-03H, **Regitar:** RC-03H, **WAI/Transpo:** LR71180
APPLICATION / APLICACIÓN:
 Truck Fire Department.
ALTERNATOR / ALTERNATOR:
LESTER: 7613

LEECE NEVILLE
GA1601

FEATURES / CARACTERÍSTICAS: 150A, Diodes 3x50A, Plate Negative
REPLACES / REEMPLAZA:
Mobiletron: RC-04H; **Regitar:** RC-04H; **WAI Transpo:** LR71181
APPLICATION / APLICACIÓN:
 Truck Fire Department.
ALTERNATOR / ALTERNATOR:
LESTER: 7613; **PIC:** 270423

LUCAS
GA1137

FEATURES / CARACTERÍSTICAS: 85A, Diodes: 6x35A Dish, with diode trio Ø ext: 115 mm, B+ Post: M6x40 mm, D+ Post: M4x27 mm, W Post: M5x52 mm
REPLACES / REEMPLAZA:
Lucas: 80150, 80367, 84469, 84469H, 84886, 84886E, UBB137; **Regitar:** RL-09H; **Cargo:** 132721; **WAI/Transpo:** ILR568
APPLICATION / APLICACIÓN:
FORD: Tractor, Fiesta with alternator Lucas;
LAND ROVER
ALTERNATOR / ALTERNATOR:
LUCAS: 24129, 24161, 24616A, 24206, 24207, 24217, 24220, 24221, 24221A, 24221D, 24240, 54022058A, 54022058B, 54022060A, 54022097A, 54022097B, 54022162, 54022191, 54022192, 54022193, 54022197, 54022229, 54022235, 54022242, 5402244, 54022255, 54022262, 54022282, 54022306, 54022309, 54022379, 54022483, 54022552, 54022616, 54022635, 54022648, 54022663, 54022666

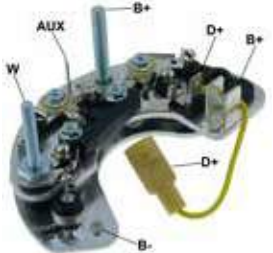
LUCAS
GA1138

FEATURES / CARACTERÍSTICAS: 85A, Diodes 6x35A, with diode trio, B+ Post: M6x40 mm, W Post: M5x52 mm
REPLACES / REEMPLAZA:
Lucas: 80556, 84201, 84422, 84455, 84499, 84499F, UBB133, UBB135, UBB141; **Regitar:** RL-01H; **Cargo:** 131304; **WAI/Transpo:** ILR566
APPLICATION / APLICACIÓN:
LAND ROVER: Range Rover 3.5, Defender 2.5 Diesel, Land Rover 2.5;
FORD: Escort, Fiesta, Granada 1.8, 2.0, Orion, Scorpio, Sierra, Transit.;
MASSEY FERGUSSON: Tractors;
NEW HOLLAND: Tractors;
PERKINS: Engines
ALTERNATOR / ALTERNATOR:
LUCAS: 24129, 24145, 24145A, 24145D, 24156, 24157, 24157AVE, 24158, 24161, 24161A, 24169, 24198, 24198A, 24198B, 24198E, 24199, 24199A, 24199B, 24200, 24200A, 24208, 24240, 24245, 24246, 24246B, 24256, 24256A, 24256B, 24256C, 24256D, 24273, 24273A, 24274, 24274D, 24276, 24277, 24294, 24294B, 24327, 24327A, 51022337D, 54022053, 54022054, 54022058A, 54022058B, 54022059, 54022060A, 54022096, 54022097A, 54022097B, 54022108, 54022109, 54022162, 54022167, 54022178, 54022182, 54022186, 54022188, 54022191, 54022192, 54022193, 54022193, 54022195, 54022196, 54022196B, 54022206, 54022211, 54022212, 54022214, 54022217, 54022218, 54022219, 54022220, 54022225, 54022225A, 54022226, 54022227, 54022228, 54022229, 54022234D
VOLTAGE REGULATOR:
 GA148

LUCAS
GA1139

FEATURES / CARACTERÍSTICAS: 85A, Diodes 6x35A, with diode trio, B+ Post: M6x52 mm, D+ Post: M5x30 mm, W Post: M5x47 mm
REPLACES / REEMPLAZA:
Lucas: 84976, 28500, 28506; **Regitar:** RL-10H; **Cargo:** 136324; **WAI/Transpo:** ILR576
APPLICATION / APLICACIÓN:
NISSAN: Primera 1.6 Sedan, Hatch/B
ALTERNATOR / ALTERNATOR:
LUCAS: 24286

LUCAS
GA1214

FEATURES / CARACTERÍSTICAS: 70A, 6x35A, B+: M6x42mm, External Diameter: 112mm
REPLACES / REEMPLAZA:
Lucas: 84456, UBB140; **Transpo:** ILR570; **Cargo:** 132718; **Mobiletron:** RL06H; **Regitar:** RL-06; **As-Poland:** ARC4005
APPLICATION / APLICACIÓN:
FORD: Transit Box 2.5 1996, Transit Bus 2.5 1991>1992, Transit Tourneo 2.5 1994>1997, Transit 2500 1986>1992
ALTERNATOR / ALTERNATOR:
 Ford: 864F-10300-FD, 864F-10300-FE, 864F-10K359-FC, 864F-10K359-FD, 864F-10K359-FE, 864FX-10K359-FE, 894F-10300-AA, 894FX-10300-AA, 914F-10300-AA, 914F-10300-AB, R894FX-10300-AA

LUCAS
GA1140

FEATURES / CARACTERÍSTICAS: 43A, 6x25A

REPLACES / REEMPLAZA:

Cargo: 130643; **As-Poland:** ARC4010; **Transpo:** ILR166; **Mobiletron:** RL-08; **Regitar:** RL-08

APPLICATION / APLICACIÓN:

MASSEY FERGUSON: MF-1200 1971>1972, MF-44B Wheel Loader 1971>1977

BARBER GREENE FINISHER: SA35 Perkins Engines 1976>1984, SA41 Perkins Engines 1976>1997, SB110 Perkins Engines 1972>1984, SB111 Perkins Engines 1973>1984, SB30 Perkins Engines 1976-1997

ALTERNATOR / ALTERNATOR:

MASSEY FERGUSON: 1096-462-M91, 3743-639-M91; **PERKINS ENGINE:** 2871622, 2871A101, 2871A121, 2871A129

VOLTAGE REGULATOR:

GA159

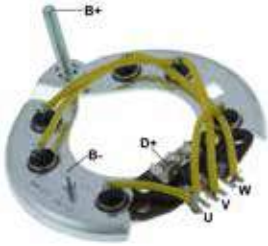
LUCAS
GA1271

FEATURES / CARACTERÍSTICAS: 85A, Diodes 6x35A, with diode trio

REPLACES / REEMPLAZA:

Lucas: 352.13.672, 352.13.437

APPLICATION / APLICACIÓN:

FORD: Ford Pick-up F 1000, Truck F350;

PERKINS: Motor Prima;

RENAULT: Clio 1.6, Trafic TA12, TA52, T312 and T352.

ALTERNATOR / ALTERNATOR:

LUCAS: 35213845, 35213680, 35213670, 35214170, 7702099331, 7702099330, 91TR-10300A, 9120080231

VOLTAGE REGULATOR:

GA610 / GA690

LUCAS
GA1272

FEATURES / CARACTERÍSTICAS: 85A, Diodes 6x 35A , with diode trio

REPLACES / REEMPLAZA:

Lucas: 352.13.894

APPLICATION / APLICACIÓN:

FORD: F 1000, F 4000, Truck F350.

ALTERNATOR / ALTERNATOR:

LUCAS: 35213855, TNM 903015RA

LUCAS
GA1273

FEATURES / CARACTERÍSTICAS: 85A, Diodes 6x 35A, with diode trio

REPLACES / REEMPLAZA:

Lucas: 352.13.682

APPLICATION / APLICACIÓN:

FORD: Escort 1.8 with AC, Versailles with and without AC;

VW: Gol, Santana 2.0 with and without AC.

ALTERNATOR / ALTERNATOR:

LUCAS: 35213790, 35213865, 35213970, 35214130, 026903015RD, 026903015RB, 0279090156

VOLTAGE REGULATOR:

GA540 / GA990

LUCAS
GA1274

FEATURES / CARACTERÍSTICAS: 85A, Diodes 6x 35A, with diode trio

REPLACES / REEMPLAZA:

Lucas: 352.13.274

APPLICATION / APLICACIÓN:

FORD: Escort Guarujá, Hobby L/ GL with CHT and 1000;

VW: Gol, Voyage, Saveiro with CHT/AE 1.6, Gol 1000.

ALTERNATOR / ALTERNATOR:

LUCAS: 35213725, 35213730

VOLTAGE REGULATOR:

GA705 / GA990

LUCAS
GA1120

FEATURES / CARACTERÍSTICAS: 50A, 3x35A Diodes, Negative Plate, compatible with GA1274

REPLACES / REEMPLAZA:

Lucas: 352.13.120

APPLICATION / APLICACIÓN:

FORD: Escort Guarujá, Hobby L/ GL with CHT and 1000;

VW: Gol, Voyage, Saveiro with CHT/AE 1.6, Gol 1000

ALTERNATOR / ALTERNATOR:

...

LUCAS
GA1404

FEATURES / CARACTERÍSTICAS: 105A, 3x35A Diodes 35A 35A, Positive Plate, Compatible with GA1274

REPLACES / REEMPLAZA:

Lucas: 352.13.404

APPLICATION / APLICACIÓN:

FORD: Escort Guaruja, Hobby L/ GL with CHT and 1000;

VW: Gol, Voyage, Saveiro with CHT/AE 1.6, Gol 1001

ALTERNATOR / ALTERNATOR:

...

LUCAS
GA1408 // NEW //

FEATURES / CARACTERÍSTICAS: 65A, 6x35A, B+ M6X28mm, External Diameter 112mm

REPLACES / REEMPLAZA:

Nissan: 23230-Q9000; **Mobiletron:** RL-22H; **Regitar:** RL-22H; **AS-Poland:** ARC4011; **Era:** 215501; **Cargo:** 138808; **Transpo:** ILR569

APPLICATION / APLICACIÓN:

NISSAN: Bluebird 1600 T12/T72 1986>1990, Bluebird 1800 T12/T72 1986>1990, Bluebird 2000 T12/T72 1986>1990

ALTERNATOR / ALTERNATOR:

LUCAS: 24223, 24223A, 24235, 24235A/D, 54022238; **NISSAN:** 23100-Q9000

MAGNETI MARELLI
GA1130 // NEW //

FEATURES / CARACTERÍSTICAS: 100A, Avalanche Diodes 6x50A, B+: M8X41.0mm, External diameter: 110mm

REPLACES / REEMPLAZA:

Magneti Marelli: 63625002, 85552103, 85552104, 85552105, 85552106, 85552107, 85552108, 85552109, 85552110; **Mobiletron:** RI-35; **AS-Poland:** ARC4037; **Transpo:** IXR640; **Cargo:** 231025; **Era:** 215961

APPLICATION / APLICACIÓN:

FIAT: 500 1200/1400 2008>2012, Bravo 1400 16V / 16V TURBO 2007>2012, Doblo Box Body/Estate 2010, Grande punto 1.2 2005, Grande punto 1.4 2005, Idea 1400 16V 2004>2010, Panda 1.2 2010, Punto 1.2 16V 1999>2006, Stilo 1400 16V 2004>2007; **ALFA ROMEO:** Mito 1.4 2008>2011; **CATERPILLAR:** D80 C4.4, 4.41L Cat. Dsl. 2008>2013, AP255E C2.2 Caterpillar Dsl. 2015, CB14 C1.1, 1.3L Caterpillar Dsl. 2008>2014, CB24B C1.5, 1.5L Caterpillar Dsl. 2014>2016, CC24B C1.5, 1.5L Caterpillar 2015, D50 C4.4, 4.41L Cat. Dsl. 2006>2007

JCB: 530 Perkins 3711HO Dsl. 1998>2007; **OPEL:** Corsa D 1.2 2009>2011, Corsa D 1.4 2006; **CASE AGRICULTURAL**

TRACTOR: JX100U Iveco 4-239 Diesel 2002>2012, JX1060C Iveco 3-179 2003>2008, JX80U Iveco 4-239 Diesel 2002>2012, JX95 Iveco 4-239 Diesel 2002>2014; **NEW HOLLAND:** TL100 4 Cyl. 3.91L 3908cc 238cid 1998>2004, TL70 4 Cyl. 3.61L 3613cc 220cid 1998>2004, TL80 4 Cyl. 3.91L 3908cc 238cid 1998>2004, TL90 4 Cyl. 3.91L 3908cc 238cid 1998>2004, TN60DA/TN60SA/TN70DA/TN70SA 2.9L (57HP) 2004>2008

ALTERNATOR / ALTERNATOR:

FIAT: 46407647, 46420960, 46530060, 46530261, 46544329, 46554402, 46554404, 46554405, 46736968, 46740238, 46765838, 46782212, 46782213, 46800158, 46813059, 46843091, 46843093, 51700670, 51700675, 51700675, 51709131, 51709133, 51714791, 51714794, 51727333, 51784846, 51854903, 51854912, 51859038, 51859042, 51859044, 51859053, 51880173, 55185076, 60816557, 71722862, 71784031, 71794526, 91600758; **ALFA ROMEO:** 51880173, 52003532, 71784509; **CATERPILLAR:** 225-3141, 225-3143; **OPEL:** 13-222-929, 13153237, 13222934, 13222935, 13222936, 13256932, 13256933, 13283344BW, YZ13153237; **CASE:** 47134024, 47134024R, 500364130; **NEW HOLLAND:** 500364130

MAGNETI MARELLI
GA1300

FEATURES / CARACTERÍSTICAS: 95A, Diodes 8x35A Avalanche (Zener), B+ Post M8, Ø: 111mm

REPLACES / REEMPLAZA:

Magneti Marelli: 636.23.701, 636.24.901, PR520435; **Regitar:** RI-19H; **Cargo:** 138800; **WAI/Transpo:** IXR634

APPLICATION / APLICACIÓN:

FIAT: Brava, Palio, Punto;

LAND ROVER

ALTERNATOR / ALTERNATOR:

MAGNETI MARELLI: 63321287, A 115 IM, A 127IM, 63321240

MAGNETI MARELLI
GA1301

FEATURES / CARACTERÍSTICAS: 85A, Diodes 6x35A Avalanche (Zener), B+ Post M8, Ø: 111mm

REPLACES / REEMPLAZA:

Magneti Marelli: 63623301, RDD35, 6362350, 636 233 01, 636 235 01, PR520436; **Regitar:** RI-14; **Cargo:** 136423; **WAI/Transpo:** IXR633

APPLICATION / APLICACIÓN:

FIAT: Pálio, Tempra, Punto, Marea, Bravo, Brava, Scudo, Lancia

ALTERNATOR / ALTERNATOR:

MAGNETI MARELLI: 0633 2020 3010, 0633 2020 04010, 0633 2020 19010, 0633 2020 27010, 0633 2020 38010, 0633 2120 0010, 0633 2120 04010, 0633 2120 05010, 0633 2120 33010, 0633 2120 34010, 0633 2120 35010, 0633 2120 52010

VOLTAGE REGULATOR:

GA121 / GA122 / GA122R

MAGNETI MARELLI
GA1302

FEATURES / CARACTERÍSTICAS: 85A, Diodes 6x35A Avalanche (Zener), B+ Post M8, Ø: 111mm

REPLACES / REEMPLAZA:

GM: 93369033; **Magneti Marelli:** PR520561

APPLICATION / APLICACIÓN:

Corsa, Celta, Prisma, Classic 95>09

ALTERNATOR / ALTERNATOR:

MAGNETI MARELLI: 93.390.879; **GM:** 93260364, 93339575, 93390879

VOLTAGE REGULATOR:

GA121 / GA129 / GA151

MAGNETI MARELLI
GA1303

FEATURES / CARACTERÍSTICAS: 85A, Diodes 6x35A Avalanche (Zener), B+ Post: M6, Ø 111mm

REPLACES / REEMPLAZA:

Magneti Marelli: 85582601010, PR520568

APPLICATION / APLICACIÓN:

FORD: Focus 1.8, 2.0 00>05, EcoSport, Fiesta

ALTERNATOR / ALTERNATOR:

MAGNETI MARELLI: 85582601010, 63341678

VOLTAGE REGULATOR:

GA123

MAGNETI MARELLI
GA1306

FEATURES / CARACTERÍSTICAS: 120A, Diodes 6x50A Avalanche (Zener), Post B+ M8, Ø 120mm

REPLACES / REEMPLAZA:

Magneti Marelli: 63624201, RDD42, RDD42A, RDD760724; **Lucas:** UBB814; **Regitar:** RI-23H; **Cargo:** 138377; **WAI/Transpo:** IXR642; **AS Poland:** ARC4016

APPLICATION / APLICACIÓN:

ALFA ROMEO: 145, 146, 155, GTV Spider;

FIAT: Bravo, Barchetta, Marea, Palio, Punto 90, Ducato 1.9TD;

LANCIA: Nueva, Delta, Dedra K 2.4TD.

ALTERNATOR / ALTERNATOR:

MAGNETI MARELLI: 63320333, 63320304, 63320332, 63320286, 63320277, 63320280, 63320348, 63320339, 63320338, 63320256, 63320341, 63320298, 63320303, 63320340, 63320296, 63320279, 63320283, 63320292;

MAGNETI MARELLI
GA1307

FEATURES / CARACTERÍSTICAS: 85A, Diodes 6x35A, Post B+: M6, Ø 105mm, with diode trio

REPLACES / REEMPLAZA:

Magneti Marelli: 54209382, 63320303, 54209741, 00084574, 84574; **Regitar:** RI-16H; **Cargo:** 136740; **WAI/Transpo:** IXR542

APPLICATION / APLICACIÓN:

FIAT: Punto, Palio, Tempra, Tipo;

LAND ROVER: 820 2.0 Diesel

ALTERNATOR / ALTERNATOR:

MAGNETI MARELLI: 63320283, 63320292, 63320333, 63320304, 63320332, 63320286, 63320277, 63320280, 63320348, 63320339, 63320338, 63320256, 63320341, 63320298, 63320303, 63320340, 63320296, 63320279; 54022238, 54022437, 54022453, 54022458, 54022459, 54022469, 54022470, 54022510, 54022527, 54022536, 54022547, 54022591, 54022592, 54022606, 54022631, 54022633, 54022646, 54022647, 54022651, 54022656, 63320235, 63320303, 63320312, 63320313, 63320314, 63321227, 63321229, 63321231, 63321232, 63321237, 63321241, 63321245, 63321246, 63321253, 63321285, 63321299, 63321313, 63321324, 63321343, 63321358, 63321397, 63321405, 63321406, 63321412, 63321422, 63324235, 63324271, 63324320, 63324322, 63324332, 63324380, 63324390

MAGNETI MARELLI
GA1406 // NEW //

FEATURES / CARACTERÍSTICAS: 90A, Diodes 6x35A Avalanche, B+: M6x29.8mm, External Diameter 107mm

REPLACES / REEMPLAZA:

Cargo: 231026; **AS-Poland:** ARC4019

APPLICATION / APLICACIÓN:

CITROËN: Berlingo 1.6 2008, C1 1.4 2005>2014, C5 1.8/2.0 16V 2001>2004, C8 2.0/2.2 2002, Xsara Picasso 1.6/1.8 2000>2005;

PEUGEOT: 206 1100/1400/1600/1900/2000 1998>2005, Partner 1400/1900 2001>2010;

FIAT: Scudo box 1.9 2004>2006, Ulysse 2.0 2002>2011;

FORD: Focus 1400/1600 zetec 1998>2005, Focus C-Max 1600 2003>2007, Focus II 1400/1600 2004>2010

ALTERNATOR / ALTERNADOR:

CITROËN/ PEUGEOT: 57057F, 9638275780, 9633782580, 9634561280, 9637075380, 9638827580, 9641398480, 9654343080, 9665067980;

FORD: 1136390, 1151214, 1215766, 1215771, 1301496, 1301511, 1301530, 1305962, 1322573, 1361258, 1361259, 1426014, 1450641, 1511220, 1708472, 1748637, 1M5T-10300-BA, 1M5T-10300-BC, 2M5T-10300-AD, 3N11-10300-AA, 3N11-10300-AB, 3N11-10300-AC, 3N11-10300-AD, 3N11-10300-AE, 3N11-10300-AF, 3N11-10300-AG, 98AB-10300-DA, 98AB-10300-DB, 98AB-10300-DC, 98AB-10300-DD, 98AB-10300-DE, 98AB-10300-DF, 98AB-10300-DG, 98AB-10300-DH, 98AB-10300-DJ, 98AB-10300-DJ, 98AB-10300-GC, 98AB-10300-GD, 98AB-10300-GE, 98AB-10300-GF, 98AB-10300-GG, 98AB-10300-GH, 98AB-10300-GJ, 98AB-10300-GK, 98AB-10300-GL, 98AB-10300-JA, 98AB-10300-JB, 98AB-10300-JC, 98AB-10300-JD, 98AB-10300-JF, 98AB10300GM, M5T-10300-BD, R1M5T-10300-BD, R98AB-10300-DE1, R98AB-10300-JC1, RE3N11-10300-AF

MAGNETI MARELLI
GA1407 // NEW //

FEATURES / CARACTERÍSTICAS: 70A, Diodes 6x50A, B+: M8x19.3mm, External diameter 111mm, with trio diode

REPLACES / REEMPLAZA:

Cargo: 235365

APPLICATION / APLICACIÓN:

...

MAGNETI MARELLI
GA1474 // NEW //

FEATURES / CARACTERÍSTICAS: 90A, 6x50A, Avalanche Diode, M6X13.0mm, External Diameter 110mm

REPLACES / REEMPLAZA:

Mobiletron: RI-32H; **Transpo:** IXR631; **Cargo:** 233792; **AS-Poland:** ARC4020; **Era:** 215964

APPLICATION / APLICACIÓN:

CITROËN: Berlingo 1.6 2008, C1 1.4 2005>2014, C5 1.8/2.0 16V 2001>2004, C8 2.0/2.2 2002, Xsara Picasso 1.6/1.8 2000>2005

PEUGEOT: 206 1100/1400/1600/1900/2000 1998>2005, Partner 1400/1900 2001>2010

FIAT: Scudo box 1.9 2004>2006, Ulysse 2.0 2002>2011

FORD: Focus 1400/1600 zetec 1998>2005, Focus C-Max 1600 2003>2007, Focus II 1400/1600 2004>2010

ALTERNATOR / ALTERNADOR:

CITROËN/ PEUGEOT: 57057F, 9638275780, 9633782580, 9634561280, 9637075380, 9638827580, 9641398480, 9654343080, 9665067980

FORD: 1136390, 1151214, 1215766, 1215771, 1301496, 1301511, 1301530, 1305962, 1322573, 1361258, 1361259, 1426014, 1450641, 1511220, 1708472, 1748637, 1M5T-10300-BA, 1M5T-10300-BC, 2M5T-10300-AD, 3N11-10300-AA, 3N11-10300-AB, 3N11-10300-AC, 3N11-10300-AD, 3N11-10300-AE, 3N11-10300-AF, 3N11-10300-AG, 98AB-10300-DA, 98AB-10300-DB, 98AB-10300-DC, 98AB-10300-DD, 98AB-10300-DE, 98AB-10300-DF, 98AB-10300-DG, 98AB-10300-DH, 98AB-10300-DJ, 98AB-10300-DJ, 98AB-10300-GC, 98AB-10300-GD, 98AB-10300-GE, 98AB-10300-GF, 98AB-10300-GG, 98AB-10300-GH, 98AB-10300-GJ, 98AB-10300-GK, 98AB-10300-GL, 98AB-10300-JA, 98AB-10300-JB, 98AB-10300-JC, 98AB-10300-JD, 98AB-10300-JF, 98AB10300GM, M5T-10300-BD, R1M5T-10300-BD, R98AB-10300-DE1, R98AB-10300-JC1, RE3N11-10300-AF

MAGNETI MARELLI
GA1475 // NEW //

FEATURES / CARACTERÍSTICAS: 210A, Avalanche Diode, 6x70A, B+ M8X41.5mm, External diameter 102mm

REPLACES / REEMPLAZA:

Mobiletron: RI-23HD

APPLICATION / APLICACIÓN:

ALFA ROMEO: 145 1600 1996>2001, 145 1800 1997>2001, 145 1.6 16V 1997>2000, 145 1.8 i.e. 16V 1998>2001, 146 1600/1800 1997>2001, 146 1.6 16V 1997>2000, 146 1.8 i.e. 16V 1998

FIAT: Brava 1800/1900 1995>2002, Brava 1.8/1.9 1995>2001, Bravo 1800/1900 1995>2002, Marea 1800/1900 1995>2002, Marea Weekend 1.8/1.9 1996>2002, Punto 1.9 1999>2012

ALTERNATOR / ALTERNADOR:

MAGNETI MARELLI: 63320333, 63320304, 63320332, 63320286, 63320277, 63320280, 63320348, 63320339, 63320338, 63320256, 63320341, 63320298, 63320303, 63320340, 63320296, 63320279, 63320283, 63320292

FIAT: 46420963, 46432733

MAGNETI MARELLI
GA1476 // NEW //

FEATURES / CARACTERÍSTICAS: 100A, 6x50A, Avalanche Diode, B+: M8X30.5mm, External diameter 122mm

REPLACES / REEMPLAZA:

Mobiletron: RI-17H; **Transpo:** IXR725; **Cargo:** 138790; **Era:** 215804; **Magneti Marelli:** 063623601010, 63623601

APPLICATION / APLICACIÓN:

LAND ROVER: Defender 90 V8 4.0L 1997, Discovery V8 4.0L 1996>1998, Discovery I 3900 V8 1994>1998, Range Rover 3900 V8 1989>1995, Range Rover II 4000 V8 1994>2002, Range Rover II 4600 V8 1994>2000

ALTERNATOR / ALTERNADOR:

LAND ROVER: AMR3021, AMR3107, AMR4247

MAGNETI MARELLI: 063341353010, 54022543, 63321353, 63341353

PRESTOLITE: 20110283

MAGNETI MARELLI
GA1901 // NEW //

FEATURES / CARACTERÍSTICAS: 100A, 6x35A, Avalanche Diode, B +: M6X1.0X26mm. Outside diameter 122mm

REPLACES / REEMPLAZA:

Magneti Marelli: 063624202010, 63624202, RDD42B; **Transpo:** IXR719, IXR7597

APPLICATION / APLICACIÓN:

Caterpillar Ag. & Ind. Loader - Backhoe: 420D Cat. 3054 2003>2006, 420D Cat. 3054C 2003>2006, 432D Caterpillar 3054CT, 4.4L Dsl. 2004>2006, 432E Cat. C4.4.4.41L, Dsl. 2006>2008, 432E Caterpillar 3054CT; 4.4L Dsl. 2006>2008, 432F Cat. C4.4.4.41L, Dsl. 2012>2013; **Caterpillar Ag. & Ind. Track Tractor:** D3K Cat. C4.4.4.41L, Dsl. 2007>2014, D3K LGP Cat. C4.4.4.41L, Dsl. 2008>2012, D3K XL Cat. C4.4.4.41L, Dsl. 2008>2013, D4H LGP Cat. C4.4.4.41L, Dsl. 2002>2007, D4H XL Cat. C4.4.4.41L, Dsl. 1993>1996, D4K LGP Cat. C4.4.4.41L, Dsl. 2008>2013, D4K XL Cat. C4.4.4.41L, Dsl. 2007>2014, D5K LGP Cat. C4.4.4.41L, Dsl. 2008>2013, D5K XL Cat. C4.4.4.41L, Dsl. 2007>2015

ALTERNATOR / ALTERNADOR:

...

MAGNETI MARELLI
GA1500

FEATURES / CARACTERÍSTICAS: 85A, Diodes 6x35A, with diode trio, B+ Post M6, Thickness 17,5mm

REPLACES / REEMPLAZA:

Magneti Marelli: 636 215 01, 636 215 03, 748 774 71, 748 786 91, PRD4A, RDD15; **Lucas:** 21222124, UBB 812; **VL-Ducellier:** 593 054; **Regitar:** RI-02; **Cargo:** 131505; **WAI/Transpo:** IXR692

APPLICATION / APLICACIÓN:

FIAT; SEAT; ALFA ROMEO; AUTOBIANCHI; IVECO; LAMBORGHINI; LANCIA; SIMIT; UNIC MOTORE

ALTERNATOR / ALTERNADOR:

MAGNETI MARELLI: 633 117 75, 633 200 01, 633 200 02, 633 200 03, 633 200 04, 633 200 05, 633 200 06, 633 200 07, 633 200 08, 633 200 10, 633 200 12, 633 200 21, 633 200 22, 633 200 23, 633 200 24, 633 200 25, 633 200 28, 633 200 30, 633 200 31, 633 200 34, 633 200 47, 633 200 52, 633 200 53, 633 200 56, 633 200 57, 633 200 73, 633 200 91, 633 200 94, 633 200 97, 633 201 02, 633 201 12, 633 201, 18 633 210 00, 18 633 210 01, 18 633 210 02, 18 633 210 03, 18 633 210 04, 18 633 210 05, 18 633 210 06, 18 633 210 07, 18 633 210 08, 18 633 210 09, 18 633 210 10, 18 633 210 11, 18 633 210 13, 18 633 210 15, 18 633 210 16, 18 633 210 28, 18 633 210 29, 18 633 210 35, 18 633 210 36, 18 633 210 37, 18 633 210 39, 18 633 210 41, 18 633 210 42, 18 633 210 44, 18 633 210 45, 18 633 210 46, 18 633 210 47, 18 633 210 48, 18 633 210 49, 18 633 210 50, 18 633 210 52, 18 633 210 55, 18 633 210 58, 18 633 210 59, 18 633 210 60, 18 633 210 61, 18 633 210 63, 18 633 210 67, 18 633 210 71, 18 633 210 78, 18 633 210 79, 18 633 210 80, 18 633 210 95, 18 633 210 97, 633 211 02, 633 211 03, 633 211 07, 633 211 09, 633 211 10, 633 211 12, 633 211 13, 633 211 37, 633 211 38, 633 211 59, 633 211 65, 633 211 71, 633 211 72, 633 211 75, 633 211 76, 633 211 89, 633 211 97, 633 214 28; **FIAT:** 5999868, 599986, 7533853, 7541822, 7541823, 7546342, 7546343, 7546660, 7546686, 7552675, 7554830; **PIC:** 202111, 202128

VOLTAGE REGULATOR:

GA117

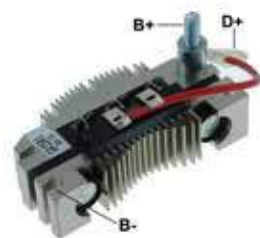
MAGNETI MARELLI
GA1501

FEATURES / CARACTERÍSTICAS: 85A, Diodes 6x35A, with diode trio, B+ Post M6, Thickness 19,5mm

REPLACES / REEMPLAZA:

Magneti Marelli: 633 200 13, 633 200 18, 633 210 21, 633 210 56, 633 210 64, 633 210 22, 633 200 26, RDD 16, 633 200 16, 633 210 19, 633 210 23, 636 216 01, 633 200 15, 633 200 17, 633 210 20, 633 210 25, PR520486; **Regitar:** RI-02; **Cargo:** 131505;

WAI/Transpo: IXR693

APPLICATION / APLICACIÓN:

FIAT: Tempra, Tipo 1.6/ 2.0

ALTERNATOR / ALTERNADOR:

MAGNETI MARELLI: 5402243B, 54022443B, 54022510, 54022536, 54022591, 54022646, 54022647, 54022651, 54022653, 54022, 63324233, 63324286, 63324322, 63324374, 63324380, 63324390, 64022656, 64280325, 64280328, 63320013, 63320015, 63320016, 63320017, 63320018, 63320020, 63320026, 63320032, 63320035, 63320040, 63320044, 63320045, 63320048, 63320049, 63320055, 63320058, 63320082, 63320083, 63320105, 63320110, 63320111

VOLTAGE REGULATOR:

GA119

MAGNETI MARELLI
GA1503

FEATURES / CARACTERÍSTICAS: 85A, Diodes 6x35A, with diode trio, B+ Post M8, Thickness 17,5mm
REPLACES / REEMPLAZA:
Magneti Marelli: 636 229 01, RDD29; **Cargo:** 139218
APPLICATION / APLICACIÓN:
FIAT
ALTERNATOR / ALTERNATOR:
MAGNETI MARELLI: 63320060

MAGNETI MARELLI
GA1504

FEATURES / CARACTERÍSTICAS: 120A, Diodes 6x50A, with diode trio, B+ Post M6, Thickness 19,5mm
REPLACES / REEMPLAZA:
Magneti Marelli: 63622001, PR520488; **Cargo:** 136675; **Regitar:** RI-11H
APPLICATION / APLICACIÓN:
FIAT: Tempra 1.8ie SW, SLX, SX, Tipo 1.6ie, 1.8ie 16V, 1.8 ie DGT;
RENAULT: Express GTL, R11 1.4 Turbo, R5 1.1 TL, GTL, R9 1.1, 1.2 TC, 1.4;
SEAT: Ibiza 1.2, 1.5, Malaga 1.5, Ronda 1.2, 1.5
ALTERNATOR / ALTERNATOR:
MAGNETI MARELLI: 63321084, 63321083, 63320046, 63320042, 63321096
VOLTAGE REGULATOR:
 GA119

MAGNETI MARELLI
GA1505

FEATURES / CARACTERÍSTICAS: 85A, Diodes 6x35A, B+ Post M6, Thickness 19,5mm
REPLACES / REEMPLAZA:
Magneti Marelli: 63622201, RDD22, 063622201010,; PR520489
APPLICATION / APLICACIÓN:
FIAT: Tempra 1.8ie, Tipo 1.6ie, 1.8ie 16V, Marengo 1.9d;
LANCIA: Delta 1.9d, Prisma 1.9d, td
ALTERNATOR / ALTERNATOR:
MAGNETI MARELLI: 63320041, 63321083

MAGNETI MARELLI
GA1507

FEATURES / CARACTERÍSTICAS: 80A, 6x35A Diode, B+: M6X11mm, Distance between holes: 70mm
REPLACES / REEMPLAZA:
Mako: 85553102, MK00531
APPLICATION / APLICACIÓN:
FIAT; FORD
ALTERNATOR / ALTERNATOR:
 ...

MAGNETON
GA1996 // NEW //

FEATURES / CARACTERÍSTICAS: 90A, Diode 8x50A, B+: M6X18.3mm, External diameter 115mm, with trio diodes
REPLACES / REEMPLAZA:
Magneton: 0135940, 0135941, 0140880, 0140881, 443930135940; **Mobiletron:** RK-03; **Cargo:** 231721; **AS-Poland:** ARC4033, ARC9036; **Code:** ARC-MT143I
APPLICATION / APLICACIÓN:
SKODA: Felicia 1.3 1994>2001, Felicia 1.3 Fun 1997>2001, Felicia 1.3 LX 1994>1998, Felicia 1.3 Lxi 1994>1998
ALTERNATOR / ALTERNATOR:
MAGNETON: 441040032266, 443113516590, 443113516591, 9516590, 9516591
SKODA: 047903015M

MAGNETON
GA1997

FEATURES / CARACTERÍSTICAS: 70A, 6x35A, Avalanche Diode B+: M6x18.7mm, External Diameter: 114mm

REPLACES / REEMPLAZA:

Magneton: 0135240, 013524, 0140830, 0140831; **Elccor:** ARC-MT003; **Cargo:** 134977; As-Poland: ARC9019

APPLICATION / APLICACIÓN:

ZASTAVA: 101, Yugo 45

SKODA: Favorit, Felicia

ALTERNATOR / ALTERNATOR:

MAGNETON: 443113515241, 443113516241, 443113516620, 443113516623, 443113516650, 443113516653, 443113516660, 443113516661, 443113516662, 443113516710, 443113516711, 443113516714, 443113516750, 443113516751, 443113516752, 443113516760, 443113516761, 443113516762, 443113516764, 443113516765, 443113516870, 443113516872, 443113516875

MAHLE
GA1485 // NEW //

FEATURES / CARACTERÍSTICAS: 95A, 8x35A, Avalanche Diode B+: M5x0.8x26.5mm/ M8x1.25x22.2mm

REPLACES / REEMPLAZA:

Mahle: MGX918, 16915733, 72739472; **Letrika:** 16.915.733

APPLICATION / APLICACIÓN:

JCB: Fork-lifts

ALTERNATOR / ALTERNATOR:

MAHLE: 11.204.467, AAK5820, AAK5840, AAK5881;

LETRIKA: 11.204.215, 11.204.893

MANDO
GA1358

FEATURES / CARACTERÍSTICAS: 95A, Diodes 8x35A, Distance between holes: 90mm, with capacitor

REPLACES / REEMPLAZA:

Mando: TA600C04602, RTF49900; **Regitar:** RM-117; **Cargo:** 138205; **WAI/Transpo:** IYR9058

APPLICATION / APLICACIÓN:

HYUNDAI: Accent w/1.5L w/DOHC 1997-98, Hyundai Elantra w/1.8L 1996-98, Hyundai Elantra w/2.0L 1999-00, Hyundai Tiburon w/1.8L 1997-98, Hyundai Tiburon w/2.0L 1997-00

ALTERNATOR / ALTERNATOR:

MANDO: AB190058, 3730022200; **LESTER:** 13702; **PIC:** 203304; **HYUNDAI:** 3730022200.

MANDO
GA1218

FEATURES / CARACTERÍSTICAS: 85A Diodes, B+ Post M6, with diode trio

REPLACES / REEMPLAZA:

Mando: AR175AA; **Hyundai:** 37300-32510; **WAI/Transpo:** IYR751

APPLICATION / APLICACIÓN:

KIA;

HYUNDAI

ALTERNATOR / ALTERNATOR:

HYUNDAI: 37300-32510, 37300-32511

MANDO
GA1219

FEATURES / CARACTERÍSTICAS: 8X35A

REPLACES / REEMPLAZA:

Bobcat: 6677488

APPLICATION / APLICACIÓN:

BOBCAT: 5600, A220, A300 V3300DI, S130 V2203DI, S175 V2203EB, S185 V2203TEB, S220 V3300DI, S250 V3300DI, S300V3300T, T190 V2003TEB, T200 BF4M1011F, T300 V3300, X331 V2203EB

HYUNDAI: Accent 1.5/ 1.6 2000>2002, Elantra 2.0 2001>2002

ALTERNATOR / ALTERNATOR:

MANDO: AB180128; **HYUNDAI:** 37300-23600

VOLTAGE REGULATOR:

GA419

MANDO
GA1248 // NEW //

FEATURES / CARACTERÍSTICAS: 105A, 8X35A, B+: M5X7.2mm, Distance between holes: 100mm

REPLACES / REEMPLAZA:

Mitsubishi: A860T40270; **Transpo:** IMR10068

APPLICATION / APLICACIÓN:

MAZDA CAR: RX-7 R2 1.3L 1308cc 1993>1995

ALTERNATOR / ALTERNATOR:

MITSUBISHI: A3T08591;

MAZDA: N3A1-18-300A, N3A1-18-300R

MASTER SPORT
GA1999

FEATURES / CARACTERÍSTICAS: 6x50A, Avalanche Diode, External diameter: 112mm
REPLACES / REEMPLAZA:
MASTER SPORT: 139680/F
APPLICATION / APLICACIÓN:
 ...
ALTERNATOR / ALTERNATOR:
 ...

MITSUBISHI
GA1323

FEATURES / CARACTERÍSTICAS: 150A, 12x35A Avalanche Diode, B+: M8X46mm
REPLACES / REEMPLAZA:
Mitsubishi: A5184-D1345-4120Y
APPLICATION / APLICACIÓN:
FORD: Fusion L4 2.0L 2013>2016, Fusion L4 2.5L 2013>2016, Mondeo V Saloon 2012
ALTERNATOR / ALTERNATOR:
Mitsubishi: A002TX2681ZC, A2TX2681ZC;
Ford: DS7T-10300-HA
VOLTAGE REGULATOR:
 GA719

MITSUBISHI
GA1327

FEATURES / CARACTERÍSTICAS: 150A | 12x35A, Avalanche Diode B+: M6x10mm, Diameter: 122mm
REPLACES / REEMPLAZA:
 ...
APPLICATION / APLICACIÓN:
NISSAN: Murano II 94>07, NP300 Navara 04, NP300 Navara Pritsche/Fahrgestell 08, Pathfinder III 05
ALTERNATOR / ALTERNATOR:
Mitsubishi: A2TX1781;
Nissan: 23100-1AT1A
VOLTAGE REGULATOR:
 GA769

MITSUBISHI
GA1332

FEATURES / CARACTERÍSTICAS: 12A, 12x35A, B+: M8x46mm, Avalanche Diode, Diameter: 128mm
REPLACES / REEMPLAZA:
 ...
APPLICATION / APLICACIÓN:
RENAULT: Master III 2.3 CDTI 2010>2016, Master III 2.3 dCi 2010>2016, Master III 2.3 dCi 2012>2016;
NISSAN: NV400 2.3 dCi 2011>2016
ALTERNATOR / ALTERNATOR:
Mitsubishi: A003TX0481
VOLTAGE REGULATOR:
 GA762

MITSUBISHI
GA1333

FEATURES / CARACTERÍSTICAS: 130A, 12x35A, B+: M8x41mm, Avalanche Diode, Diameter: 128mm
REPLACES / REEMPLAZA:
 ...
APPLICATION / APLICACIÓN:
NISSAN: Sentra 2.0 2010>
ALTERNATOR / ALTERNATOR:
Mitsubishi: A2TX4381ZC; **Nissan:** 23100 3RZ1A
VOLTAGE REGULATOR:
 GA769

MITSUBISHI
GA1334

FEATURES / CARACTERÍSTICAS: 130A, 12x35A, Avalanche Diode
REPLACES / REEMPLAZA:
 ...
APPLICATION / APLICACIÓN:
Subaru: Tribeca, Legacy, Outback
ALTERNATOR / ALTERNATOR:
Mitsubishi: A3T J3591; **Subaru:** 23700 AA620
VOLTAGE REGULATOR:
 GA886

MITSUBISHI
GA1338

FEATURES / CARACTERÍSTICAS: 90A, 12x35A Block avalanche diodes 24-32V, Diameter: 115 mm
REPLACES / REEMPLAZA:

...

APPLICATION / APLICACIÓN:

HONDA: Fit 2014>, City 2014>

ALTERNATOR / ALTERNATOR:

Honda: AHGA91; **Mitsubishi:** A5TJ0391ZT

VOLTAGE REGULATOR:

GA869

MITSUBISHI
GA1344

FEATURES / CARACTERÍSTICAS: 140A, 12X35A Diode Avalanche

REPLACES / REEMPLAZA:

Mitsubishi: 31127-R1A-A01

APPLICATION / APLICACIÓN:

Honda: Civic 2012>, Fit 1.5 16V 2012>

ALTERNATOR / ALTERNATOR:

Mitsubishi: A5TJ0191ZC, **Honda:** AHGA81

VOLTAGE REGULATOR:

GA144

MITSUBISHI
GA1345

FEATURES / CARACTERÍSTICAS: 110A, 12X35A Avalanche

REPLACES / REEMPLAZA:

Mitsubishi: 98084-D0005-4Y27Y

APPLICATION / APLICACIÓN:

NISSAN: Sentra

ALTERNATOR / ALTERNATOR:

Mitsubishi: A2TJ0281ZC;

Nissan: 23100EM01B

VOLTAGE REGULATOR:

GA877

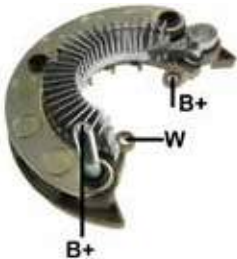
MITSUBISHI
GA1357

FEATURES / CARACTERÍSTICAS: 95A, 12x35A Block standard diodes

REPLACES / REEMPLAZA:

MOBILETRON: RM175

APPLICATION / APLICACIÓN:

HONDA: New Fit 1.3/1.5 2008>, City 1.3/1.5 2009>

ALTERNATOR / ALTERNATOR:

MITSUBISHI: A5TJ0091ZD, AHGA77;

HONDA: 31100RB0004, 31100RB00041, 31100RB0A0243

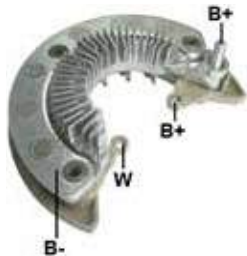
MITSUBISHI
GA1359

FEATURES / CARACTERÍSTICAS: 150A, 12x50A Avalanche Diodes

REPLACES / REEMPLAZA:

Mitsubishi: 94675, C1323, 7920H

APPLICATION / APLICACIÓN:

FORD: Fusion 2003-08 Ford w Police Option 2006-08 Mercury Milan 2.3L.

ALTERNATOR / ALTERNATOR:

Mitsubishi: A003TG0891

VOLTAGE REGULATOR:

GA871

MITSUBISHI
GA1288 // NEW //

FEATURES / CARACTERÍSTICAS: 90A, Diodes 6x35A, Distance between holes: 71mm

REPLACES / REEMPLAZA:

Cargo: 132087; **Transpo:** IMR7111; **Mobiletron:** RM-60; **Regitar:** RM-60

APPLICATION / APLICACIÓN:

MITSUBISHI: FD-10 / FD-14 / FD-15 Mitsubishi S4E 1981>1983, FD-20 Mitsubishi S4E / S4S 1983>1992, FD-23 S4E Mitsubishi Diesel 1983>1992, FD-25 Mitsubishi S4E / S4S 1983>1999, FD-28 S4E Mitsubishi Diesel 1981>1992, FD-35AT Mitsubishi S4E / S4S 1981>1983

NISSAN LIFT TRUCK: AEH H20 Engine 1975>1976, CEH H20 Engine 1975>1976, Various Models Z20 Engine 1979>2003, 620 L4 2.0 1978>1979, 720 L4 2.0 1980

ALTERNATOR / ALTERNATOR:

CLARK: 4307228, 43100326; **MITSUBISHI:** MD022515, MD025215, MD060901, MD062007, 34468-16100, 34468-18200, 34468-26100, 34468-28100, 34468-28200; **NISSAN / INFINITI:** 23100-B9810; **TOWMOTOR:** 973485

MITSUBISHI
GA1289 // NEW //

FEATURES / CARACTERÍSTICAS: 50A, diodes 6x35A, B+: M5X44.5mm, distance between holes: 80mm

REPLACES / REEMPLAZA:

Cargo: 132130; **AS-Poland:** ARC5016; **Transpo:** IMR8041; **Mobiletron:** RM-65; **Regitar:** RM-65

APPLICATION / APLICACIÓN:

DODGE: Ram 50 2.3 1983>1985

MITSUBISHI: Mighty Max L4 2.3 Diesel 1983>1985, L200 2.5 1986>1996, Pajero I 2.3 1984>1986

ALTERNATOR / ALTERNATOR:

MITSUBISHI: MD013740, MD013742, MD061818, MD067411, MD072582, MD086015, MD086016, MD304139, MDO50190, MDO60793

VOLTAGE REGULATOR:

GA425

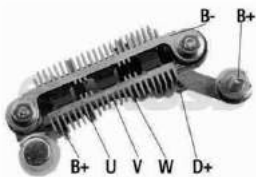
MITSUBISHI
GA1341

FEATURES / CARACTERÍSTICAS: 85A, Diodes 6x35A, Distance between holes: 75mm, Post B+ M6, with Capacitor, with triodiode

REPLACES / REEMPLAZA:

Mitsubishi: A860T22370, A860T22970, A860T25470, A860T32470; **Regitar:** RM-20; **Cargo:** 132468; **WAI/Transpo:** IMR7564

APPLICATION / APLICACIÓN:

KIA: Sportage;

MITSUBISHI: Pajero, Galant, Mirage;

CHRYSLER

ALTERNATOR / ALTERNATOR:

MITSUBISHI: A2T01583, A2T01384, A2T01483, A2T01683, A2T01783, A2T02084; **MITSUBISHI MOTORS:** MD103564, MD106319,

MD106320, MD106332, MD103372, MD103373;

MITSUBISHI
GA1348

FEATURES / CARACTERÍSTICAS: 50A, 6 x 35A

REPLACES / REEMPLAZA:

Mitsubishi: A860T 10770; **Mazda:** E356-24510, E563-24510; **Regitar:** RM-67; **Cargo:** 131542; **WAI/Transpo:** IMR8045

APPLICATION / APLICACIÓN:

MAZDA: GLC L4 1.5 1983>1985, 323 1982>1986

ALTERNATOR / ALTERNATOR:

Mazda: E563-18300, E563-18300A

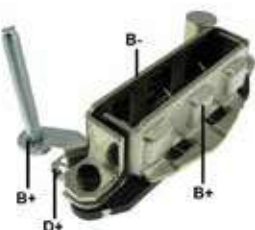
MITSUBISHI
GA1349

FEATURES / CARACTERÍSTICAS: 60A, 6 X 35A

REPLACES / REEMPLAZA:

Mitsubishi: A860T08770; **Mazda:** S215-24-510; **Regitar:** RM-73; **Cargo:** 132463; **WAI/Transpo:** IMR8545

APPLICATION / APLICACIÓN:

MAZDA: 626 L4 2.0 Diesel 1984>1985;

MITSUBISHI: FD with motors S6E, S4E, S4S Diesel 1985>2007;

MITSUBISHI FUSO: Canter FB, FE L4 3.3 1984>1989

ALTERNATOR / ALTERNATOR:

Hyundai: 37300-41010;

Mazda: RF03-18300C, SL02-18300

MITSUBISHI
GA1365

FEATURES / CARACTERÍSTICAS: 85A, Diodes 6x35A, Distance between holes: 75mm, with diode trio and capacitor

REPLACES / REEMPLAZA:

Mitsubishi: A002T24570, A2T24570, A860T13170, A860T16970; **Regitar:** RM-07; **Cargo:** 132466; **WAI/Transpo:** IMR7542

APPLICATION / APLICACIÓN:

MITSUBISHI (1985-94)

ALTERNATOR / ALTERNATOR:

MITSUBISHI: A2T02271, A2T02471, A2T02671, A2T02977, A2T03171, A2T03471, A2T03477, A2T03972, A2T04191, A2T04277, A2T09691, A2T28291, A2T41791, A2T41991, A2T42777, A2T43791, A2T43891, A2T43892, A2T48691, A2T48791, A2T49891.

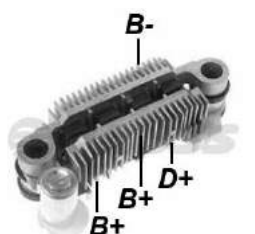
MITSUBISHI
GA1376

FEATURES / CARACTERÍSTICAS: 95A, Diodes 8x35A, Distance between holes: 75mm, with capacitor

REPLACES / REEMPLAZA:

Mitsubishi: A860T38570; **Honda:** 04311P01014; **Regitar:** RM-27; **Cargo:** 232606; **WAI/Transpo:** IMR7584

APPLICATION / APLICACIÓN:

HONDA: Civic 92-95

ALTERNATOR / ALTERNATOR:

HONDA: 31100-P00-014; **MITSUBISHI:** A5T04292;

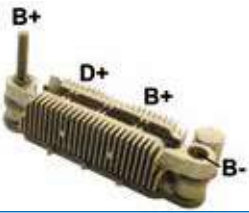
MITSUBISHI
GA1381

FEATURES / CARACTERÍSTICAS: 85A, Diodes 6x35A, Distance between holes: 85mm, With Capacitor, with diode trio

REPLACES / REEMPLAZA:

Mitsubishi: A860T29370; **Cargo:** 135229; **WAI/Transpo:** IMR8578

APPLICATION / APLICACIÓN:

MITSUBISHI

ALTERNATOR / ALTERNATOR:

MITSUBISHI: A4T58289, A4T58799, A4T59086, A4T75589, A4T58686, A4T58986, A4T59199, A6T55186, A4T58689, A4T58989, A4T59786, A6T55189, A4T58699, A4T58999, A4T66486, ME060076, A4T58786, A4T75586, ME090198

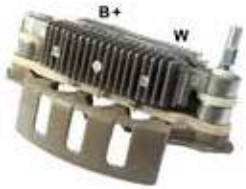
MITSUBISHI
GA1238 // NEW //

FEATURES / CARACTERÍSTICAS: 90A, 8x35A, B+: M5x0.8x4.8mm

REPLACES / REEMPLAZA:

Honda: 31150-RNA-A01; **Transpo:** IM558

APPLICATION / APLICACIÓN:

Honda: Civic L4 1.8L 1799cc R18A1 2006-2011, Honda - China Car: Civic 1.8L, Non-Turbo, Gas (R18A1) 2006, Civic 1.8L, Non-Turbo, Gas (R18A1) 2008, Honda - Europe Car: Civic 1800, VTEC 2005-2010, FR-V 1800, VTEC 2005-2010

ALTERNATOR / ALTERNATOR:

HONDA: A2TC1391ZC, 31100-RNA-A01, 31100-RNA-A012-M2, 31100-RNA-A01RM, 31100-RNE-A01, 31100-RNE-A010M2, AHGA67, AHGA75; **MITSUBISHI:** A002TC1391, A002TC1391ZC, A002TC1391ZE, A002TC1591, A002TC1591ZC, A002TC1591ZCKD

VOLTAGE REGULATOR:

GA788

MITSUBISHI
GA1245 // NEW //

FEATURES / CARACTERÍSTICAS: 120A, 6x50A, Avalanche Diode B+: M8x1.25x26.6mm

REPLACES / REEMPLAZA:

Mitsubishi: 1800A086, A860X86870; **Transpo:** IMR10045

APPLICATION / APLICACIÓN:

MITSUBISHI: Lancer MK8 Saloon 1.8 Petrol 2008>, Lancer MK8 Saloon 1.8 Flexfuel Petrol/Ethanol 2009>, Lancer MK8 Saloon 1.8 Bifuel Petrol/Gas 2010>, Lancer MK8 Estate 1.8 Mivec Petrol 2009>, Lancer MK8 Estate 1.8 (CX3A) Petrol 2008>, Lancer MK8 Estate 1.8 Bifuel Petrol/Gas 2010>, Outlander 2.0 Petrol 2006>2012, Outlander 2.4 Petrol 2006>2012, Shogun/Pajero Mk3 3.8 V6 Petrol 2007>, Shogun/Pajero Mk3 3.2 DI-D Diesel 2007>

ALTERNATOR / ALTERNATOR:

MITSUBISHI: A003TG0191, A003TG1581, A003TG1991, A003TG3181, A003TG3181MI, A003TG3791, A003TG4091, A003TG4679

VOLTAGE REGULATOR:

GA859

MITSUBISHI
GA1265 // NEW //

FEATURES / CARACTERÍSTICAS: 90A, 6x35A, B+ M5X18.5mm. PS: Distance between holes 100mm

REPLACES / REEMPLAZA:

Mitsubishi: A860T26470; **Mobiletron:** RM-80; **Regitar:** RM-80; **Era:** 216061; **Cargo:** 132714

APPLICATION / APLICACIÓN:

Mazda: 626 1978>2002

ALTERNATOR / ALTERNATOR:

MITSUBISHI: A3T01877, A3T01877A

MITSUBISHI
GA1266 // NEW //

FEATURES / CARACTERÍSTICAS: 70A, 6x35A, B +: M5x0.8x6.0mm. PS: Distance between holes 75mm

REPLACES / REEMPLAZA:

Transpo: IMR7590; **Lester:** 13330, 13649

APPLICATION / APLICACIÓN:

HONDA: Civic L4 1.6L 96>98, Civic L4 1.6L 96>98, Civic del Sol L4 1.6L 96>97, Civic del Sol L4 1.6L 96>97, Civic 1500 96>01

ALTERNATOR / ALTERNATOR:

...

MITSUBISHI
GA1270

FEATURES / CARACTERÍSTICAS: 85A, Diodes 6x35A, Distance between holes: 85 mm, B+ Post: M5x18 mm, with diodetrio and capacitor

REPLACES / REEMPLAZA:

Mitsubishi: A860T38270, B36618W60A; **Regitar:** RM-38; **Cargo:** 136977; **WAI/Transpo:** IMR8548

APPLICATION / APLICACIÓN:

FORD: Escort;

MAZDA: RX7, MX3 1.6i, 323 1.3 16V, 1.6, 1.8i, 1.8 GT, 1.8 Turbo;

KIA: Sephia 1.5, 1.6, II 1.5

ALTERNATOR / ALTERNATOR:

FORD: F1CA10346B, F1C210346B; **MITSUBISHI:** A002T34477, A2T34477, B36618300G, A2T17574, A2T35177

MITSUBISHI
GA1278 // NEW //

FEATURES / CARACTERÍSTICAS: 55A, Diode 8x35A, B+: M6X21.4mm, Distance between holes 75mm

REPLACES / REEMPLAZA:

Mitsubishi: A860T30370, A860X62470; **Suzuki:** 31621-60A20; **Transpo:** IMR7558; **Mobiletron:** RM-147; **Cargo:** 135215;

AS-Poland: ARC5009

APPLICATION / APLICACIÓN:

ASUNA TRUCK: Sunrunner L4 1.6L 1992>1993

CHEVROLET TRUCK: Tracker L4 1.6L 1989>1991

GEO TRUCK: Tracker L4 1.6L 1989>1995

GMC TRUCK: Tracker L4 1.6L 1989>1991

PONTIAC TRUCK: Sunrunner L4 1.6L 1994

SUZUKI TRUCK: Sidekick L4 1.6L 1989>1994

SUZUKI CAR: Swift L4 1.3L 1993>1994, Swift L4 1.3L DOHC 1989>1992, Vitara 1600 1988>1993, X-90 1600 16V 1995>1998

GEO CAR: Metro L4 1.3L 1992>1994

ALTERNATOR / ALTERNATOR:

MITSUBISHI: A001T03191, A001T03191ZC, A001T03195, A001T03195ZC, A005TA0791, A005TA0791ZC, A007T00191

CHEVROLET: 30016320, 96058486, 96069102

SUZUKI: 31400-33BD0, 31400-50G10, 31400-60A20, 31400-63B01, 31400-63BD1

MITSUBISHI
GA1279

FEATURES / CARACTERÍSTICAS: 65A, 6x35A, B+: M5x7mm, Diameter between holes: 85mm

REPLACES / REEMPLAZA:

MITSUBISHI: 1106-089RS; **AS-POLAND:** ARC5071

APPLICATION / APLICACIÓN:

...

ALTERNATOR / ALTERNATOR:

...

MITSUBISHI
GA1280

FEATURES / CARACTERÍSTICAS: 90A, 8x35A, B+: M8x27.5mm, Distance between holes: 100mm

REPLACES / REEMPLAZA:

Cargo: 238948; **Transpo:** IMR10054

APPLICATION / APLICACIÓN:

Iveco: Stralis 380 /410 2002>2013

Case: 335 Case 6-787 2004>2009, 335B Case 6-787 2007>2008, 340 Case 6-787 2004>2012, 340B Case 6-787 2007>2008, 327B Case 6-629 2006>2007, 330B Case 6-629 2006>2008

ALTERNATOR / ALTERNATOR:

MITSUBISHI: A004TA8492, A004TA0592

IVECO: 504028095, 504065776, 504109413, 504286394, 504349338, 504349338

CASE: 504028095

VOLTAGE REGULATOR:

GA787

MITSUBISHI
GA1281

FEATURES / CARACTERÍSTICAS: 75A, 6x35A, B+: M8x27.5mm, Distance between holes: 100mm

REPLACES / REEMPLAZA:

Cargo: 139427; **Mobiletron:** RM-87; **Regitar:** RM-87

APPLICATION / APLICACIÓN:

Hyundai: Satellite 4D56 2.5 Turbo 1997>2002, Porter D4BH 2.5 Turbo 1994>2004, H-1 4D56 2.5 Turbo 1997>2012, H-1 D4BH 2.5 Turbo 2001>2012, Starex 4D56 2.5 Turbo 1997>2012

Mazda: 929 V6 3.0 1992>1995

Nissan: Quest V6 3.0 1996>1998

ALTERNATOR / ALTERNATOR:

HYUNDAI: 37300-42354, 37300-42355, 37300-42356, 37300-42357, 37300-42358

MAZDA: JE48-18-300C

NISSAN: 23100-1B000

MITSUBISHI: MD313384, MD313395, MD315304, MD318460, MD327533, MD330332, MD354804

MITSUBISHI
GA1282 // NEW //

FEATURES / CARACTERÍSTICAS: 95A, Diodes 8x35A, B+: M8x1.25x29.2mm

REPLACES / REEMPLAZA:

Cargo: 139222; **Transpo:** IMR10066; **Mobiletron:** RM-82; **Regitar:** RM-82

APPLICATION / APLICACIÓN:

HYUNDAI: Satellite 4D56 2.5L Turbo Dsl. 1997>2002

ALTERNATOR / ALTERNATOR:

HYUNDAI: 37300-42354, 37300-42355, 37300-42356, 37300-42357, 37300-42358; **MAZDA:** JE48-18-300C; **MITSUBISHI:** MD313384, MD313395, MD315304, MD318460, MD327533, MD330332, MD354804; **NISSAN:** 23100-1B000

MITSUBISHI
GA1284

FEATURES / CARACTERÍSTICAS: 90A, Diodes 8x35A, B+: M5x7 mm, Diameter between holes: 100 mm

REPLACES / REEMPLAZA:

Mazda: N3H1-18-W60; **Mobiletron:** RM182; **Regitar:** RM-182; **Cargo:** 239995; **AS-Poland:** ARC5104; **Transpo:** IMR10047

APPLICATION / APLICACIÓN:

Mazda Car: 3 L4 2.0/2.3 2004>2006

Mazda Van: 5 L4 2.3 2006>2007

Mazda China Car: Mazda 3 2.0 Non-Turbo Gas 2006>2007, Mazda 3 2.0 Non-Turbo Gas 2010

Mazda Europe Car: 3/5 2000 2003>2010, 5 1800 2003>2010

ALTERNATOR / ALTERNATOR:

MAZDA: LF50-18-300, LF50-18-300A, LF50-18-300R0A, LF50-18-400

MITSUBISHI
GA1285

FEATURES / CARACTERÍSTICAS: 65A, 6x35A, B+: M5x7.6mm, Distance between holes: 85mm

REPLACES / REEMPLAZA:

Cargo: 233748; **AS-Poland:** ARC5108; **Transpo:** IYR9094; **Mobiletron:** RM-94; **Regitar:** RM-94

APPLICATION / APLICACIÓN:

KIA: Sephia 1.8 1998>2001, Spectra 1.8 2000>2004

ALTERNATOR / ALTERNATOR:

KIA: OK2A2-18-300, OK30D-18-300, OK2A2-18-300, OK30D-18-300, RK30D-18-300U

MITSUBISHI
GA1286

FEATURES / CARACTERÍSTICAS: 90A, 8x35A, B+: M6x22mm, Diameter between holes: 100mm

REPLACES / REEMPLAZA:

Mitsubishi: A860T31770, A860X31799, A860X34799; **Elccor:** ARC-MI097; **Cargo:** 233515; **AS-Poland:** ARC5058; **Transpo:** IMR10072; **Mobiletron:** RM-44; **Regitar:** RM-44

APPLICATION / APLICACIÓN:

NISSAN CAR: 300ZX V6 3.0 Turbo 1990>1993

ALTERNATOR / ALTERNATOR:

NISSAN: 23100-31P10, 23100-31P10R

MITSUBISHI
GA1287

FEATURES / CARACTERÍSTICAS: 70A, 6x35A, B+: M6x12.5mm, Distance between holes: 90mm

REPLACES / REEMPLAZA:

Cargo: 231426; **AS-Poland:** ARC5169; **Transpo:** IYR9094; **Mobiletron:** RM-118; **Regitar:** RM-118

APPLICATION / APLICACIÓN:

CITROËN: Berlingo 1.9 1996>2003, Evasion 1.9 1995>2000, Jumpy Box 1.9 1996>2000, Xantia 1900/2100 1997>2000, Xsara 1.9 1997>1999, ZX 1900 1994>1998

PEUGEOT: 306 1900 1993>1999, 406 1900/2100 1996>1999, 806 1900 1995>1999

ALTERNATOR / ALTERNATOR:

MITSUBISHI: A002TA1994D

CITROËN / PEUGEOT: 9624141580

MITSUBISHI
GA1290

FEATURES / CARACTERÍSTICAS: 65A, 8x35A, B+: M5x6.3mm, Distance between holes: 75mm

REPLACES / REEMPLAZA:

Mitsubishi: A860T32570; **Cargo:** 134027; **AS-Poland:** ARC5010; **Transpo:** IMR7562; **Mobiletron:** RM-23; **Regitar:** RM-23

APPLICATION / APLICACIÓN:

MAZDA: 323 1.6/1.8 1990>1991, Protege 1.8 1990>1991, 323 1300 1991>1994, 323 1600 1989>1994, MX5 1600 1990>1998

FORD: Escort 1.8 1991

ALTERNATOR / ALTERNATOR:

MITSUBISHI: A002T34377, A005T00877, A005T02777

MAZDA: B36618300, B36618300C, B36618300E, B36618300R00, BP0218300

FORD: F0CZ10346B, F0CZ10346B

VOLTAGE REGULATOR:

GA758

MITSUBISHI
GA1291

FEATURES / CARACTERÍSTICAS: 90A, 6x35A, B+: M5x7mm, Distance between holes: 100mm

REPLACES / REEMPLAZA:

Elccor: ARC-MI067; **Cargo:** 236816; **As-Poland:** ARC5094

APPLICATION / APLICACIÓN:

NISSAN: Patrol 2800 1988>1995, Patrol II Station Wagon 1989>1992

ALTERNATOR / ALTERNATOR:

MITSUBISHI: A3T03099, A860T29770

NISSAN: 23100-22J10

MITSUBISHI
GA1292

FEATURES / CARACTERÍSTICAS: 95A, 8x35A, B+: M8x28.2mm, Distance between holes: 100mm

REPLACES / REEMPLAZA:

Cargo: 231079; **AS-Poland:** ARC5042; **Transpo:** IMR10057; **Mobiletron:** RM-99HV; **Regitar:** RM-99HV

APPLICATION / APLICACIÓN:

FORD: Transit Box 2.5 1999>2000, Transit Tourneo 2.5 1997>2000, Transit LCV 2.5 1997>2000

ALTERNATOR / ALTERNATOR:

MITSUBISHI: A003TN1791

FORD: 98VB-10K359-BA, 98VB-10K359-BB, 98VB-10K359-BC, R98VB10K359BC

MITSUBISHI
GA1319

FEATURES / CARACTERÍSTICAS: 65A, 6x35A, B+: M5x7.0mm, Distance between holes: 85mm

REPLACES / REEMPLAZA:

Cargo: 235265

APPLICATION / APLICACIÓN:

CITROËN: Xsara 1900 1999>2000, Xsara Picasso 1800 16V 2000>2001, Berlingo 1900 1999>2005

PEUGEOT: 206 1100/1400/1600/1900 1998>2000, 306 1900 1999>2002, 406 2200 2000>2002, Expert 1900 1999>2006, Partner 2000 2001>2010

ALTERNATOR / ALTERNATOR:

MITSUBISHI: A002TB4791, A002TB4791A, A002TB4791B

MITSUBISHI
GA1324

FEATURES / CARACTERÍSTICAS: 110A, 8X35A, with trio and capacitor, dist. Between holes: 100 mm

REPLACES / REEMPLAZA:

Mitsubishi: A860T33970, A860T39970; **Ford:** F3XA-10304-AA, F3XY-10304-A, GYE1418; **Mazda:** SLA3-18-W60;

WAI/Transpo: IMR10060; **Regitar:** RM-48; **Cargo:** 135900; **Mobiletron:** RM-48

APPLICATION / APLICACIÓN:

MERCURY: Villager 3.0 V6 93>95;

NISSAN: Quest 3.0 V6 93>95

ALTERNATOR / ALTERNATOR:

MITSUBISHI: A004T01192, A004T01192ZC, A004T02591, A004T02591ZC, A004T29591, A004T29591ZC;

FORD: F3XA-10300-AB, F3XA-10300-AC, F3XY-10300-A, F3XY-10346-A;

FORD ENGINEERING: F3XA-AB, F3XA-AC, F3XY-A;

NISSAN/INFINITI: 23100-0B000

MITSUBISHI
GA1325

FEATURES / CARACTERÍSTICAS: 85A | 8x35A, B+: M8x28mm, Distance between centers: 85mm

REPLACES / REEMPLAZA:

Mitsubishi: A860T58070, A860X58070, MD619284; **Cargo:** 230643; **As-Poland:** ARC5061; **Transpo:** IMR85668; **Mobiletron:** RM-128; **Regitar:** RM-128

APPLICATION / APLICACIÓN:

Mitsubishi: Colt V 1.6 1995>2003, Galant VI 2.0 1996>2004, Galant VI Station Wagon 2.0 1996>2003, Lancer VI 1.6 16V 1995>2003, Pajero Pinin 1.8 1999>2007, Space Star 1.8 GDI 1998>2004;

MAZDA: 323 2000 1999>2003, 626 2000 1998>2003, Premacy 2000 1998>2003

NISSAN: Kubistar 1500 Dci 2003>2010

RENAULT: Clio II 1500 2001>2007, Kangoo 1500 2002>2010, Laguna 1500 2007>2012, Megane 1400/1500/1600 16V 2002>2010, Megane Classic 1400/1600 16V 2002>2010, Megane Scenic 1400/1500/1600 2002>2010

ALTERNATOR / ALTERNATOR:

MITSUBISHI: MD343562, A2TB0892, MD317862, MD322925, MD357737, MD363639, MD368519, MD375853; **MAZDA:** RF1S-18-300; **NISSAN:** 23100-00QA1, 23100-00QA9; **RENAULT:** 7711134728, 8200053938, 8200100907, 8200120286

MITSUBISHI
GA1326

FEATURES / CARACTERÍSTICAS: 65A, 6x35A, B+: M8x28mm, Avalanche Diode, Distance between center: 85mm

REPLACES / REEMPLAZA:

...

APPLICATION / APLICACIÓN:

MITSUBISHI: Shogun/ Pajero Mk2/ Mk2 Soft Top 2.5 TD 4WD 90>99, L200 2.5 96>07, L300 Van 2.5 86>06

ALTERNATOR / ALTERNATOR:

Mitsubishi: MD366050, A2T82899AT

VOLTAGE REGULATOR:

GA767

MITSUBISHI
GA1335

FEATURES / CARACTERÍSTICAS: 80A, 6x35A Avalanche Diode, B+: M5x6mm, Distance between holes: 75mm

REPLACES / REEMPLAZA:

...

APPLICATION / APLICACIÓN:

CITROËN: Nemo Multispace 1.4 2009>2012, Xsara 1.4, 1.6 2000>2005, Xsara Picasso 1.6 16V 2006>2010, Xsara Picasso 1.6 8V 2000>2006, Xsara Picasso 1.8 16V 2000>2010Ç

FIAT: Ulysse 2000 2002>2010Ç

PEUGEOT: 206 1.1, 1.4, 1.6, 1.9, 2.0 1998>2010, 607 2.0 16V 2001>2005

ALTERNATOR / ALTERNATOR:

Mitsubishi: A005TA6391C; **Citroën:** 9638275980; **Renault:** 7700433069; **MMB:** A001TA2291

VOLTAGE REGULATOR:

GA426

MITSUBISHI
GA1339

FEATURES / CARACTERÍSTICAS: 8x35A Avalanche Diodes, Distance Between Holes: 75mm

REPLACES / REEMPLAZA:

...

APPLICATION / APLICACIÓN:

RENAULT: Clio 1.0 2000>

ALTERNATOR / ALTERNATOR:

Mitsubishi: A001TA2291; **Renault:** 7700433069

VOLTAGE REGULATOR:

GA777

MITSUBISHI
GA1340

FEATURES / CARACTERÍSTICAS: 85A, Diodes 6x35A, Distance between holes: 85 mm, B+ Post: M8x25 mm, with diode trio

REPLACES / REEMPLAZA:

Regitar: RM-110HV; **Cargo:** 138873; **WAI/Transpo:** IMR8566

APPLICATION / APLICACIÓN:

VOLVO: VM 210, VM 240, VM 260 /98>

ALTERNATOR / ALTERNATOR:

MITSUBISHI: A002TA8891; **VOLVO:** 20498749

VOLTAGE REGULATOR:

GA874

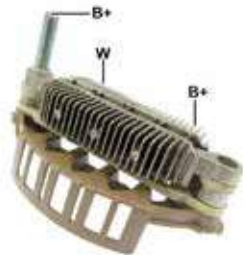
MITSUBISHI
GA1342

FEATURES / CARACTERÍSTICAS: 100 A, 8x35A Avalanche, 100mm Distance between holes, Bolt B+ M8 X 30
REPLACES / REEMPLAZA:

...

APPLICATION / APLICACIÓN:

SCANIA: 440R, G 480, P 480, R 480, Serie 5, Serie 6 with engine DC13.07 12742ccm / P270

ALTERNATOR / ALTERNATOR:

Mitsubishi: A004TR5691, A4TR5691, A004TR5491;

Scania: 1 777 299, 1 884 268

MITSUBISHI
GA1343

FEATURES / CARACTERÍSTICAS: 70A, Diodes 6x35A
REPLACES / REEMPLAZA:

...

APPLICATION / APLICACIÓN:

HONDA: Fit 1.5 2006>2008

ALTERNATOR / ALTERNATOR:

Mitsubishi: A5TA4591, A5TB0291ZT/B1391/B149;

Honda: AHGA58

VOLTAGE REGULATOR:

GA868

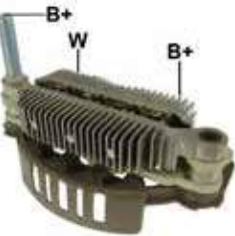
MITSUBISHI
GA1346

FEATURES / CARACTERÍSTICAS: 6x50A Block avalanche diodes
REPLACES / REEMPLAZA:

...

APPLICATION / APLICACIÓN:

MITSUBISHI: ASX, Lancer, Outlander 2010>

ALTERNATOR / ALTERNATOR:

Mitsubishi: A3TG3181, A2TG2191

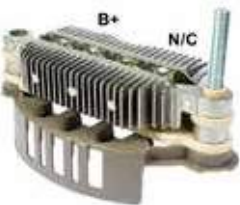
MITSUBISHI
GA1354 // NEW //

FEATURES / CARACTERÍSTICAS: 130A, 8x35A, B +: M6x1.0x27.5mm, Distance between holes 100mm
REPLACES / REEMPLAZA:

Transpo: IMR10090; **Mobiletron:** RM-131HV; **Lester:** 13595, 13764, 13892, 13892, 13955

APPLICATION / APLICACIÓN:

CHRYSLER: Sebring V6 2.5L 2497cc 152cid 1999;

DODGE: Avenger V6 2.5L 2497cc 152cid 1999

ALTERNATOR / ALTERNATOR:

...

MITSUBISHI
GA1356

FEATURES / CARACTERÍSTICAS: 105A, 6x35A Block Diodes
REPLACES / REEMPLAZA:

Mitsubishi: A860T37670, A860T39170

APPLICATION / APLICACIÓN:

Kia: Sephia L4 1.6L 1597cc 1994-1995; Europe Car; Mentor 1500 1996-2001; Shuma 1500 1999-2001; Shuma 1800 1999-2004; **Mazda:** Europe Car; 323 1600 1989-1994; MX3 1600 1991-1994; Xedos 6 1600 1993-1997

ALTERNATOR / ALTERNATOR:

KIA: OK201-18-300B

MITSUBISHI
GA1362

FEATURES / CARACTERÍSTICAS: 75A, Diodes 6x35A, 65mm, with diode trio
REPLACES / REEMPLAZA:

Mitsubishi: A860T11970, A860T13370, MD607828, MD611070; **Regitar:** RM-01HV; **Cargo:** 132039; **WAI/Transpo:** IMR6542

APPLICATION / APLICACIÓN:

MAZDA: RX7 1.1L 1984-1985, B2200 1986-1987;

KIA: Pride 1100, 1300 1991-1994;

MITSUBISHI: Dodge Truck, Plymouth

ALTERNATOR / ALTERNATOR:

MAZDA: F651-18-300, FE85-18-300, FE85-18-300A; **MITSUBISHI:** A5T30977, A5T31177

MITSUBISHI
GA1364

FEATURES / CARACTERÍSTICAS: 85A, DIODES 6x35A, with diode trio and capacitor, B+ post M6x25mm".

REPLACES / REEMPLAZA:

Ford: E8GY-10304-B, E92Z-10304-A, GYE1377; **Hyundai:** 37367-24510; **Mando:** A600C003F; **Magneti Marelli:** 940038260; **Mazda:** B675-18-W60, F8B1-18-W60; **Mitsubishi:** A860T27070, A860T27170, A860T28370; **Mitsubishi motors:** MD611778; **Regitar:** RM-10; **Cargo:** 132469; **WAI/Transpo:** IMR7556

APPLICATION / APLICACIÓN:

Dodge, Eagle, Ford, Hyundai, Mazda, Mitsubishi, Plymouth (1994-87)

ALTERNATOR / ALTERNATOR:

MANDO: 3730024500, 3730024510, AB175015, AB175019.

MITSUBISHI
GA1368

FEATURES / CARACTERÍSTICAS: 115A, 8x35A Block Diodes

REPLACES / REEMPLAZA:

Mitsubishi: A860T38670; **WAI/Transpo:** IMR10064; **Regitar:** RM-46; **Cargo:** 133882

APPLICATION / APLICACIÓN:

Ford: Probe V6 2.5L 2450cc 152cid 1993-1997; Europe Car; Probe 2500, V6, 24V 1994-1998; **Mazda:** 626 V6 2.5L 2497cc 1993-2000; **MX-3 V6 1.8L 1845cc 1992-1995; MX-6 V6 2.5L 2497cc 1993-1997; Europe Car; 323 2000, V6 1994-1998; 626 2500, V6 1992-1997; MX3 1800, V6 1991-1999; MX6 2500, V6 1991-1997; Xedos 6 2000, V6 1992-2001**

ALTERNATOR / ALTERNATOR:

MAZDA: K801-18300B

MITSUBISHI
GA1370

FEATURES / CARACTERÍSTICAS: 85A Diodes 6x35A, Distance between holes: 85mm, with diode trio and capacitor

REPLACES / REEMPLAZA:

Mitsubishi: A860T31370; **Mazda:** JE15-18-W60; **Mando:** A600C3201; **Regitar:** RM-31; **Cargo:** 135041; **WAI/Transpo:** IMR8544

APPLICATION / APLICACIÓN:

MAZDA: MPV 2.5L, 2.6L, 3.0L

ALTERNATOR / ALTERNATOR:

LESTER: 13253, 13272, 13282; **MAZDA:** JE1518300A; **MITSUBISHI:** A002T13977, A2T13977, A2T19677, A2T20191, A2T32899, A3T00792, JE1518300A, MD50190

MITSUBISHI
GA1371

FEATURES / CARACTERÍSTICAS: 85A, Diodes 6x35A, Distance between holes: 85mm, with diode trio and capacitor, B+ Post: M6x25 mm.

REPLACES / REEMPLAZA:

Ford: E8PZ10304A; **Regitar:** RM-30; **Cargo:** 233511; **WAI/Transpo:** IMR8542

APPLICATION / APLICACIÓN:

FORD: Thunderbird.

ALTERNATOR / ALTERNATOR:

FORD: E8SF10300AA, E8SF10346A, E8SZ10346A; **LESTER:** 13189. **MITSUBISHI:** A3T01496, A3T01496MA; **MOTORCRAFT:** GLE254; **PIC:** 203325

MITSUBISHI
GA1372

FEATURES / CARACTERÍSTICAS: 85A, Diodes 6x35A, Distance between holes: 85mm, with diode trio and capacitor

REPLACES / REEMPLAZA:

Mitsubishi: A 860 T 34070; **Regitar:** RM-31; **Cargo:** 135041; **WAI/Transpo:** IMR8546

APPLICATION / APLICACIÓN:

FORD: Probe 2.2 turbo Intercooler;

MAZDA: MX6, RX7, 929 2.2i, 626 2.0i, 16V, 2.2i, 2.2i Stationcar

ALTERNATOR / ALTERNATOR:

MITSUBISHI: A002T19991, A2T13977, A2T19877, A2T19991, A3T00792, F28518300C; **FORD:** F02E10346D, F28518300B, F29018300A, F29018300B, F8B118300G; **PIC:** 203354, 203373; **MOTORCRAFT:** GLE302; **LESTER:** 13297

MITSUBISHI
GA1373

FEATURES / CARACTERÍSTICAS: 85A, Diodes 6x35A, Distance between holes: 85mm, with diode trio and capacitor

REPLACES / REEMPLAZA:

Mitsubishi: A 860 T 28670; **Ford:** E8PZ10301B, E8PZ-10304-B, GYE1380; **Regitar:** RM-29; **Cargo:** 134297; **WAI/Transpo:** IMR8540

APPLICATION / APLICACIÓN:

FORD: Tempo, Taurus, Mercury Topaz, Sable.

ALTERNATOR / ALTERNATOR:

MITSUBISHI: A3T01596, A3T01596MA, A3T01598, A3T01598MA; **FORD:** E83F10300AA, E83F10300AB, 83F10300BA, E83Z10346A, E8DF10300AB, E8DZ10346A, F73J10346AA; **PIC:** 203319, 203326; **MOTORCRAFT:** GLE250, GLE251, GLE439; **LESTER:** 13188, 13190

MITSUBISHI
GA1375

FEATURES / CARACTERÍSTICAS: 95A, Diodes 8x35A, Distance between holes: 85mm, with diode trio and capacitor

REPLACES / REEMPLAZA:

Ford: E9PZ10304A; **Regitar:** RM-32; **Cargo:** 233746; **WAI/Transpo:** IMR8570

APPLICATION / APLICACIÓN:

FORD: Probe, Taurus, Tempo, Mercury Topaz

ALTERNATOR / ALTERNATOR:

FORD: E9DF-1300-BB, E9DZ910346-A, FO2U-1300-AA, FO2U-10300-AC, FO2Z-10346-A, F33U-10300-BA, F33Z-10346-A, F3DU-10300-DA, F3DZ-10346-C, GLE-261, GLE-274, GLE-339, GLE-341; **MITSUBISHI:** A3T00491, A3T00896, A3T00896ZC, A3T12691, A3T12792, A3T12792ZC

MITSUBISHI
GA1377

FEATURES / CARACTERÍSTICAS: 95A, Diodes 8x35A, Distance between holes: 85mm, with diode trio and capacitor

REPLACES / REEMPLAZA:

Cargo: 230593; **WAI/Transpo:** IMR85104

APPLICATION / APLICACIÓN:

FORD: Europe

ALTERNATOR / ALTERNATOR:

MITSUBISHI: A2T32692; **FORD:** 92AB10300JA

MITSUBISHI
GA1378

FEATURES / CARACTERÍSTICAS: 85A, Diodes 6x35A, Distance between holes: 85mm, with diode trio and capacitor

REPLACES / REEMPLAZA:

Regitar: RM-90; **Cargo:** 137860; **WAI/Transpo:** IMR85106

APPLICATION / APLICACIÓN:

FORD: Europe

ALTERNATOR / ALTERNATOR:

MITSUBISHI: A2T14591, A2T28792; **FORD:** 91AB10300A, 92AB10300FA

MITSUBISHI
GA1379

FEATURES / CARACTERÍSTICAS: 85A, Diodes 8x35A, Distance between holes: 85mm, with diode trio and capacitor

REPLACES / REEMPLAZA:

Mitsubishi: A860T23270, MD 611 586; **Regitar:** RM-34; **Cargo:** 135042; **WAI/Transpo:** IMR8574

APPLICATION / APLICACIÓN:

DODGE: Stealth;

HYUNDAI: Sonata;

MITSUBISHI: 3000GT

ALTERNATOR / ALTERNATOR:

LESTER: 13352; **MANDO:** AB190012; **MITSUBISHI:** A003T00692, A3T00692, A3T04292, MD112323, MD112323; **PIC:** 203384, 203384A

MITSUBISHI
GA1380

FEATURES / CARACTERÍSTICAS: 95A, Diodes 8x35A, Distance between holes: 85mm, With Capacitor , with diode trio

REPLACES / REEMPLAZA:

Mitsubishi: A860X29999, A860T29999; **Regitar:** RM-35; **Cargo:** 135260; **WAI/Transpo:** IMR8576

APPLICATION / APLICACIÓN:

NISSAN: Stanza, 200SX 1.8 DOHC Turbo

ALTERNATOR / ALTERNATOR:

MITSUBISHI: A2T13894, A2T14694; **LESTER:** 13286; **PIC:** 203292, 203310, 203322D, 203364; **NISSAN:** 2310035F10

MITSUBISHI
GA1382

FEATURES / CARACTERÍSTICAS: 85A, Diodes 6x35A, Distance between holes: 85mm, B+ PostM8x25, with diode trio and capacitor

REPLACES / REEMPLAZA:

Cargo: 137861; **Regitar:** RM-37; **WAI/Transpo:** IMR8580

APPLICATION / APLICACIÓN:

MITSUBISHI;

MAZDA: 626, MX6

ALTERNATOR / ALTERNATOR:

MITSUBISHI: A2T20091, A2T20091ZC; **PIC:** 203341, 203341A, 203356, 203442; **LESTER:** 13299; **FORD:** F2F818300B

MITSUBISHI
GA1383

FEATURES / CARACTERÍSTICAS: 95A, Diodes 8x35A 8x35A . Distance between holes: 75mm. B+ Post M6x20
REPLACES / REEMPLAZA:
Regitar: RB-45; **Cargo:** 231118; **WAI/Transpo:** IBR331
APPLICATION / APLICACIÓN:
HONDA: Civic 1.7 2001-2004
ALTERNATOR / ALTERNATOR:
MITSUBISHI: A5TA7091; **HONDA:** 31100PLMA01
VOLTAGE REGULATOR:
 GA837

MITSUBISHI
GA1384

FEATURES / CARACTERÍSTICAS: 85A, Diodes 8x35A, Distance between holes: 85mm, B+ Post M8x25, With Capacitor, With triodiode
REPLACES / REEMPLAZA:
Cargo: 137861; **Regitar:** RM-37; **WAI/Transpo:** IMR8580
APPLICATION / APLICACIÓN:
MITSUBISHI;
MAZDA: 626, MX6
ALTERNATOR / ALTERNATOR:
MITSUBISHI: A2T20091; **PIC:** 203341, 203341A, 203356, 203442; **LESTER:** 13299; **FORD:** F2F818300B

MITSUBISHI
GA1385

FEATURES / CARACTERÍSTICAS: 85A Diodes 6x35A, Distance between holes: 85mm, with diode trio and capacitor
REPLACES / REEMPLAZA:
Mitsubishi: MD618568; A 860 T 38770; **Cargo:** 136979; **Regitar:** RM-36; **WAI/Transpo:** IMR8590
APPLICATION / APLICACIÓN:
CHRYSLER; MITSUBISHI
ALTERNATOR / ALTERNATOR:
LESTER: 13430, 13439, 13450. **MITSUBISHI:** A002T34892, A002T34991, A002T34992, A002T35091, A002T36391, A002T36392, A002T38491, A002T38891, A002T38892, A002T39891, A002T40092, A002T83291, A002TA3491, A2T20091, A2T34892, A2T34992, A2T35091, A2T35092, A2T36391, A2T36392, A2T38491, A2T38891, A2T38892, A2T40092, MD175810, MD175811, MD177244, MD184278, MD184279, MD184280, MD184281, MD189658, MD189659, MD191402, MD193323, MD19543, MD309837, MD317401; **PIC:** 203297, 203297A, 203298, 203299

MITSUBISHI
GA1386

FEATURES / CARACTERÍSTICAS: 95A, 8x35A Diodos, B+ Parafuso M8, Distance between holes: 100mm
REPLACES / REEMPLAZA:
Mitsubishi: A860X64570; **Regitar:** ; **Cargo:** 230884; **WAI/Transpo:** IMR10046
APPLICATION / APLICACIÓN:
GM: Ómega Australiano 3.8 V6;
KIA: Sephia
ALTERNATOR / ALTERNATOR:
MITSUBISHI: A003TB0191, A003TG4091; **GM:** 92173959
VOLTAGE REGULATOR:
 GA776

MITSUBISHI
GA1387

FEATURES / CARACTERÍSTICAS: 85A, Diodes 6x30A, with diode trio and capacitor, Hole B+: M8, OD 85mm
REPLACES / REEMPLAZA:
Mitsubishi: A860T39070, A860T42670, A860T42770, A860X44170, MD618734, MD618752, MD618811, A2T82378, A860X42770 ;
Regitar: RM-59, RM-50HV; **Cargo:** 137849; **WAI/Transpo:** IMR8588
APPLICATION / APLICACIÓN:
MITSUBISHI: L200 (2001-93), Galant 1996-1998
ALTERNATOR / ALTERNATOR:
MITSUBISHI: A2TA0991, A2T33891, A2T38392, A2T37976, A2T38391, A2T80591, A2T82791, A2T82792, A2T82792ZC, A2T82899, A3T11891, MD194482, MD304129, MD306649, MD310997, MD313939, MD314235, MD314236, MD314374, MD315430, A2T38391, A2T37976, MD310997, MD327535, A2TA0891ZC, A2TA0891
VOLTAGE REGULATOR:
 GA797

MITSUBISHI
GA1389

FEATURES / CARACTERÍSTICAS: 90A, Diodes Avalanche 6x35A, without diode trio, 85mm, M8x55mm B+ Holes
REPLACES / REEMPLAZA:
 -
APPLICATION / APLICACIÓN:
NISSAN: Sentra 1.6, Tida 1.6, Livina 1.6/1.8, Nissan Frontier 2008>2012, Nissan Pathfinder 2.5 DCI
ALTERNATOR / ALTERNATOR:
MITSUBISHI: A2TG0881ZC, A2TG11081ZT, A3TG2681AE, A003TG2681, A003TG2681AE, A3TG2681AE; **NISSAN:** 23100EL010, 23100EB310, 23100EB31A, 23100EB1071A, 23100EB71A
VOLTAGE REGULATOR:
 GA427

MITSUBISHI
GA1390

FEATURES / CARACTERÍSTICAS: 95A, Diodes 8x35A, Distance between holes: 100mm, with diode trio and capacitor

REPLACES / REEMPLAZA:

Mitsubishi: A860T35270, E9PZ10304B; **Regitar:** RM-41; **Cargo:** 135252; **WAI/Transpo:** IMR10040

APPLICATION / APLICACIÓN:

FORD: Thunderbird, Mercury Cougar;

HYUNDAI: Alliance

ALTERNATOR / ALTERNATOR:

MITSUBISHI: A3T45694, A4T00790, A4T00796, A4T03591, MD149750; **PIC:** 203324, 203360A; **LESTER:** 13212;

FORD: E9SF10300DA, F3SU10300AA, F3SZ10346A; **MOTORCRAFT:** GLE265, GLE338

MITSUBISHI
GA1391

FEATURES / CARACTERÍSTICAS: 95A, Diodes 8x35A, Distance between holes: 100mm, with diode trio and capacitor

REPLACES / REEMPLAZA:

Mitsubishi: A 860 T 23070, A 860 T 28070, MD602227, MD611564, MD611768; **Cargo:** 132793; **Regitar:** RM-40; **WAI/Transpo:** IMR10042

APPLICATION / APLICACIÓN:

MITSUBISHI: Van & Wagon;

DODGE: Dodge Eagle;

CHRYSLER

ALTERNATOR / ALTERNATOR:

MITSUBISHI: A003T02193, A3T03393, MD126110, A003T03392, A3T03471, MD133171, A003T03393, A3T03492, MD135171, A003T03493, A3T03493, MD136838, A003T06591, A3T04493, MD136839, A003T08293, A3T08293, MD141855, A003T41876, A3T41876, MD158495, A003T45694, A3T41892, MD162518, A3T02192, A3T45693, MD168989, A3T02193, A4T41876, MD611564, A3T03391, A4T41892, MD611678, A3T03392, A4T45694, MD111233

VOLTAGE REGULATOR:

GA802

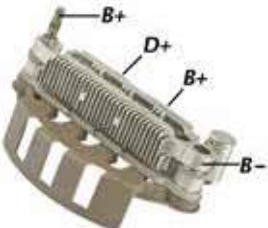
MITSUBISHI
GA1392

FEATURES / CARACTERÍSTICAS: 95A, Diodes 8x35A, Distance between holes: 100mm, with diode trio and capacitor

REPLACES / REEMPLAZA:

Mitsubishi: A 860 T 30170, 23700AA061, 23830AA030, A860T29870; **Cargo:** 135229; **Regitar:** RM-42; **WAI/Transpo:** IMR10044

APPLICATION / APLICACIÓN:

SUBARU: XT 2.7, Canter f60d, FE444

ALTERNATOR / ALTERNATOR:

MITSUBISHI: A3T03891; **PIC:** 203387, 203387A; **SUBARU:** 23700AA061

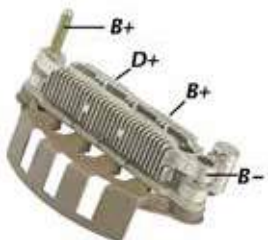
MITSUBISHI
GA1393

FEATURES / CARACTERÍSTICAS: 85A, Diodes 6x35A, Distance between holes: 100mm, with diode trio and capacitor

REPLACES / REEMPLAZA:

Mitsubishi: A 860 T 26070, MD611742; **Regitar:** RM-43; **Cargo:** 137486; **WAI/Transpo:** IMR10050

APPLICATION / APLICACIÓN:

MITSUBISHI: 3000GT, Diamont;

CITROËN

ALTERNATOR / ALTERNATOR:

MITSUBISHI: A004T01793, A4T01893, MD160539, A004T01893, A4T02991, MD160540, A004T02991, A4T03091, MD197468, A004T03091, A4T03191, MD197469, A4T01793; **LESTER:** 13435; **PIC:** 203440A

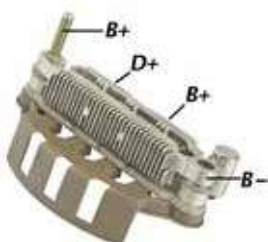
MITSUBISHI
GA1394

FEATURES / CARACTERÍSTICAS: 95A, Diodes 8x35A, Distance between holes: 100mm, with diode trio and capacitor

REPLACES / REEMPLAZA:

Mitsubishi: A 860 T 26070, MD611742; **Regitar:** RM-43; **Cargo:** 137486; **WAI/Transpo:** IMR10050; **Mobiletron:** RM-43,

AS-Poland: ARC5041

APPLICATION / APLICACIÓN:

MITSUBISHI: 3000GT;

DODGE: Stealth;

HYUNDAI: Sonata

ALTERNATOR / ALTERNATOR:

MITSUBISHI: A004T01493, MD150657, A004T03191, MD197470, A3T05882, ME017595, A4T01493; **PIC:** 203383, 203383A, 203440, 203383B; **HYUNDAI:** 3730035571, 3730035573; **MANDO:** AB111057; **LESTER:** 13351, 13703

VOLTAGE REGULATOR:

GA806

MITSUBISHI
GA1395

FEATURES / CARACTERÍSTICAS: 85A, Diodes 6x30A, with diode trio and capacitor, OD: 75mm

REPLACES / REEMPLAZA:

Mitsubishi: A860T13270, A860T17570, A860T17970, A860T24270; **Regitar:** RM-08; **Cargo:** 132040; **WAI/Transpo:** IMR7544

APPLICATION / APLICACIÓN:

MAZDA: III Hatch back 1.1 /1.3 /1.5 /1.6 1985-1987, 626 B1800 /B2000, Pickup RX7

ALTERNATOR / ALTERNATOR:

MITSUBISHI: A2T17872, A2T41677, A2T44991

MITSUBISHI
GA1396

FEATURES / CARACTERÍSTICAS: 120A, 8X35A Avalanche Diodes

REPLACES / REEMPLAZA:

Transpo: IMR10052; **Regitar:** RM-155HV

APPLICATION / APLICACIÓN:

CITROËN - EUROPA: C4 1400 16V 2004-2010, C4 1600 16V 2004-2010, C4 2000 16V 2004-2010, C5 1800 16V 2001-2010, C5 2000 16V 2001-2004, C8 2000 16V 2002-2010, C8 2200 16V 2002-2010, Xsara Picasso 1800 16V 2000-2010;

CITROËN - EUROPA VAN: Berlingo - LCV 1400 2008-2012, Berlingo - LCV 1600 16V 2008-2012;

CITROËN LCV - EUROPA VAN: Berlingo 1600 16V 2008-2012;

PEUGEOT - EUROPA: 207 1400 16V KFU 2006-2010, 207 1600 16V NUF 2006-2010, 307 2000 16V 2001-2010, 407 2200 16V 2004-2010, 607 2200 16V 2000-2005, 807 2000 16V 2002-2005, 807 2200 16V 2002-2010;

PEUGEOT - EUROPA VAN: Partner Tepee 1600 16V 2008-2012

ALTERNATOR / ALTERNATOR:

MITSUBISHI: 9640088080, A003TB2691, 9640088080, A003TB2691, A860T13270, A860T17570, A860T17970, A860T24270

VOLTAGE REGULATOR:

GA426

MITSUBISHI
GA1398

FEATURES / CARACTERÍSTICAS: 95A, Diodes 6x35A, Distance between holes: 100mm, with diode trio and capacitor

REPLACES / REEMPLAZA:

...

APPLICATION / APLICACIÓN:

MITSUBISHI: Pajero 2.8D 94-98, Canter;

NISSAN: King Van

ALTERNATOR / ALTERNATOR:

MITSUBISHI: A2TA3098, A3TA3098, A3TA6098, A3TO9199, A3TO9698, A3TO9699, A3TO9799

VOLTAGE REGULATOR:

GA857

MITSUBISHI
GA1399

FEATURES / CARACTERÍSTICAS: 95A, 8x35A Diodes, B+ Bolt M8, with diode trio and capacitor, Dist between holes: 100mm

REPLACES / REEMPLAZA:

Mitsubishi: A860X47070, ME701716; **Cargo:** 139111; **Regitar:** RM-116

APPLICATION / APLICACIÓN:

MITSUBISHI: Montero, Pajero 3.2L; **RENAULT:** Sandero, Logan, Clio II, Scénic I, Mégane I, Cabriolet I All 1.4/1.6 16V

ALTERNATOR / ALTERNATOR:

MITSUBISHI: A003T08699, A001TA3792, A003T09699, A003TB1299, A3T08699, A3T09699, A3TB1299, ME200696, ME200698, ME202971; **RENAULT:** 8200660052

VOLTAGE REGULATOR:

GA857

MITSUBISHI
GA1360

FEATURES / CARACTERÍSTICAS: 85A, Diodes 6x35A, Distance between holes: 65mm, with diode trio and capacitor

REPLACES / REEMPLAZA:

Mitsubishi: A 860 T 16770, MD611254; **Regitar:** RM-04HV; **Cargo:** 132791; **WAI/Transpo:** IMR6548

APPLICATION / APLICACIÓN:

HYUNDAI: Mirage, Plymouth Champ;

MITSUBISHI: Colt 1.2, 1.5;

Lancer .2, 1.5, Lancer 1800 4WD, Space Wagon1.8;

Tredia 1500, 1600;

NISSAN: Micra 1.2 87-92

ALTERNATOR / ALTERNATOR:

MITSUBISHI: A1T01991, A1T40791, A1T40891

MITSUBISHI
GA1361

FEATURES / CARACTERÍSTICAS: 85A, Diodes 6x35A, Distance between holes: 65mm, with diode trio and capacitor
REPLACES / REEMPLAZA:

Mitsubishi: A 860 T 22770; **Cargo:** 132789; **Subaru:** 23830-KA070; **Regitar:** RM-03; **WAI/Transpo:** IMR6540

APPLICATION / APLICACIÓN:

SUBARU: Justy;

SUZUKI: Alto 1.0, Swift 1.0, 1.03 GTi 16V, Samurai 1.3, Vitara 1.6i;

KIA: Pride 1.3;

MAZDA: 121

ALTERNATOR / ALTERNATOR:

MITSUBISHI: A1T02592; **SUBARU:** 23700KA190, 23700KA240, 23700KA360

MITSUBISHI
GA1363

FEATURES / CARACTERÍSTICAS: 85A, Diodes 6x35A, Distance between holes: 65mm, with diode trio and capacitor
REPLACES / REEMPLAZA:

Mitsubishi: A 860 T 20570; **Cargo:** 133263; **Lucas:** 21513131m; **Nissan:** 2312453A10; **Regitar:** RM-05; **WAI/Transpo:** IMR6570

APPLICATION / APLICACIÓN:

NISSAN: Sunny 1.0, 1.3 8V, 1.5 8V, 1.6 8V

ALTERNATOR / ALTERNATOR:

MITSUBISHI: A5T41592, A5T41592B; **NISSAN:** 2310053A10, 2310053A11

MITSUBISHI
GA1409 // NEW //

FEATURES / CARACTERÍSTICAS: 50A, Diodes 6x35A, B+:M8x1.25x30mm

REPLACES / REEMPLAZA:

Mitsubishi: A860T46570, A860X46570; **Transpo:** IMR7588

APPLICATION / APLICACIÓN:

HYUNDAI: Amica 1000 2000>2003, Amica 1100 2006>2010, Atos 1000 1998>2005;

MITSUBISHI: Minica 1994

ALTERNATOR / ALTERNATOR:

MITSUBISHI: A001T06391, A001T06672, A001TA0091, A001TA0291, A001TA0491, A001TA0791, A001TA0891; **HYUNDAI:**

37300-02503, 3730002503AT; **MANDO:** AB160108; **MAGNETI MARELLI:** 063532613010

MITSUBISHI
GA1410 // NEW //

FEATURES / CARACTERÍSTICAS: 80A, Diodes 8x35A, B+: M5x0.8x19.2mm

REPLACES / REEMPLAZA:

Honda: 31127-RNA-A01; **Transpo:** IMR8579; **Cargo:** 330593

APPLICATION / APLICACIÓN:

HONDA: Civic VIII Hatchback 1.8 2005>, FR-V 1.8 2004>, Civic MK7 1.6 2005>, Civic MK7 1.8 2005>2012

ALTERNATOR / ALTERNATOR:

MITSUBISHI: A002TC1391, A002TC1391ZC, A002TC1391ZE, A002TC1591, A002TC1591ZC, A002TC1591ZCKD;

HONDA: 31100-RNA-A01, 31100-RNA-A012-M2, 31100-RNA-A01RM, AHGA67

MITSUBISHI
GA1479 // NEW //

FEATURES / CARACTERÍSTICAS: 50A, Avalanche Diodes 8x35A, B+: M8x1.25x30.0mm

REPLACES / REEMPLAZA:

Mitsubishi: A860X85470; **Transpo:** IMR6571

APPLICATION / APLICACIÓN:

CATERPILLAR: Truck C3000 Mits. K21 Eng. 2004>2009

ALTERNATOR / ALTERNATOR:

MITSUBISHI: A007TA3371, A007TA3377

MITSUBISHI
GA1855

FEATURES / CARACTERÍSTICAS: 110A, 8x35A, B+: M5x5.6mm, Distance between holes: 100mm, with trio diode

REPLACES / REEMPLAZA:

Cargo: 235565; **Transpo:** IMR10094

APPLICATION / APLICACIÓN:

HYUNDAI: Terracan 2900 2003>2010;

KIA: Sedona 2900 2001>2006

ALTERNATOR / ALTERNATOR:

HYUNDAI: 37300-4X000, 37300-4X001, 37300-4X002, 37300-4X500, 37300-4X501, 37300-4X502, 37300-4X503

MITSUBISHI
GA1879

FEATURES / CARACTERÍSTICAS: 85A, Diodes 8x35A, with diode trio and capacitor
REPLACES / REEMPLAZA:

...

APPLICATION / APLICACIÓN:

HYUNDAI: HR 92>

ALTERNATOR / ALTERNATOR:
 TA000A64201, 37300-42711

VOLTAGE REGULATOR:
 GA979

NIPPON DENSO
GA1160

FEATURES / CARACTERÍSTICAS: 70A, Diodes Dish 8x35A, Ø 100 mm, B+ Post M6x43mm.
REPLACES / REEMPLAZA:

Nippon Denso: 021580-2160, 0211580-2230; **Toyota:** 27357-63020; **Regitar:** RN-13; **Cargo:** 132082; **WAI/Transpo:** INR720

APPLICATION / APLICACIÓN:

HONDA: Accura;

ISUZU;

TOYOTA;

ALTERNATOR / ALTERNATOR:

ISUZU: 8944086740, 8941313572; **HONDA:** 31100PD2024, 31100PH7004, 31100PK1004, 31100PK2004; **NIPPON DENSO:** 100211-1000, 100211-1001, 100211-1010, 100211-1030, 100211-1040, 100211-1041, 100211-1050, 100211-1060, 100211-1061, 100211-080, 100211-1081, 100211-1090, 100211-1091, 100211-1110, 100211-1111, 100211-1180, 100211-1360, 100211-1361, 100211-2000, 100211-2010, 100211-2011, 100211-2020, 100211-2021, 100211-2030, 100211-2031, 100211-2050, 100211-2060, 100211-2061, 100211-2070, 100211-2071, 100211-2100, 100211-2102, 100211-2130, 100211-2140, 100211-2150, 100211-2151, 100211-2160, 100211-2170, 100211-2500, 100211-2550, 100211-2551, 100211-3030, 100211-3040, 100211-3041, 100211-3060, 100211-3090, 100211-3091, 100211-3110, 100211-3111, 100211-3150, 100211-3151, 100211-3160, 100211-3170, 100211-3180, 100211-3181, 100211-3182, 100211-3220, 100211-3221, 100211-3260, 100211-3300, 100211-3310, 100211-3320, 100211-3321, 100211-3352, 100211-3390, 100211-3391, 100211-3400, 100211-3401, 100211-3430, 100211-3510, 100211-3550, 100211-3551, 100211-5350, 100211-7000, 100211-7040, 100211-7050, 100211-7060, 100211-7061, 100211-7070, 100211-7100, 100211-7180, 100211-7260, 100211-7320, 100211-7330, 100211-7430, 100211-7450, 100211-7460, 100211-7470, 100211-7500, 100211-7570, 100211-7571, 100211-7800, 100211-7810, 100211-7820, 100211-7821, 100211-7970, 100211-8910, 100211-8911, 100211-9710, 100211-9730, 100211-9731, 100211-9132, 100211-9732, 100211-9770, 100211-9780, 100211-9790, 100211-9840, 100211-0060, 100211-0070, 100211-0071, 101211-0120, 101211-0130, 101211-0190, 101211-0200, 101211-0201, 101211-0250, 101211-0340, 101211-0350, 101211-0530, 101211-0531, 101211-0550, 101211-0551, 101211-0590, 101211-0720, 101211-0722, 101211-0723, 101211-0730, 101211-0740, 101211-0830, 101211-4120, 101211-4121, 101211-4122, 101211-4130, 101211-4131, 101211-4132

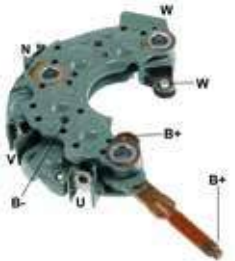
NIPPON DENSO
GA1250

FEATURES / CARACTERÍSTICAS: 70A, Diodes Dish 8x35, A Ø 90 mm, B+ Post M6x43mm.

REPLACES / REEMPLAZA:

Nippon Denso: 021580-2250; **Regitar:** RN-16; **Cargo:** 132541; **WAI/Transpo:** INR725; **Magneti Marelli:** PR520424

APPLICATION / APLICACIÓN:

HONDA: Civic, Accura CRX;

TOYOTA: Tercel

ALTERNATOR / ALTERNATOR:

HONDA: 31100PE003; **ISUZU:** 8944136210; **DENSO:** 1002111270; **TOYOTA:** 270601504; **LESTER:** 14757, 14851, 14935

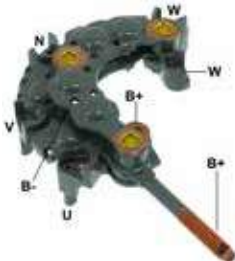
NIPPON DENSO
GA1251

FEATURES / CARACTERÍSTICAS: 95A, Diodes 8x35A

REPLACES / REEMPLAZA:

Nippon Denso: 021580-3130; **Cargo:** 132540; **Lucas:** 21510074; **Regitar:** RN-15; **WAI/Transpo:** INR724

APPLICATION / APLICACIÓN:

ISUZU: Aska 2.0 Turbo;

SUZUKI: Alto 1.0, Vitara 1.6i, Swift 1.0, 1.3, 1.6, Samurai 1.3, SJ413;

TOYOTA: Corolla 1.3i, Starlet 1.3

ALTERNATOR / ALTERNATOR:

NIPPON DENSO: 100211-1430, 100211-1550, 100211-1551, 100211-1560, 100211-1570, 100211-1571, 100211-4070, 100211-4071, 100211-4130, 100211-1431, 100211-4150, 100211-4170, 100211-4171, 100211-4260, 100211-4290, 100211-4350, 100211-4351, 100211-6270, 100211-6600, 100211-6710, 100211-6720, 100211-6860, 100211-6870, 100211-6960, 100211-6990, 100211-9230, 100211-9430, 100211-9431, 100211-2020, 101211-2021, 101211-2022, 101211-2130, 101211-2240, 101211-2310, 101211-2360, 101211-3020, 101211-3021

NIPPON DENSO
GA1252

FEATURES / CARACTERÍSTICAS: 95A, Diodes 8x50A

REPLACES / REEMPLAZA:

Nippon Denso: 021580-4120, 021580-4490; **Cargo:** 135416; **WAI/Transpo:** INR727P

APPLICATION / APLICACIÓN:

CHRYSLER: Laser, LeBaron, New Yorker, Dodge 600, Aries Caravan;

PLYMOUTH: Acclaim, Reliant, Voyager, Turismo

ALTERNATOR / ALTERNATOR:

NIPPON DENSO: 101211-4590, 121000-2430, 121000-2490, 121000-2680

NIPPON DENSO
GA1253

FEATURES / CARACTERÍSTICAS: 95A, Diodes 8x35A

REPLACES / REEMPLAZA:

NIPPON DENSO: 0215802511, 0215802512, 0215802521, 0215802522, 2735770081; **Cargo:** 135250; **Regitar:** RN-12;

WAI/Transpo: INR401

APPLICATION / APLICACIÓN:

ISUZU: Gemini 1.5, 1.6 Gti 16V;

TOYOTA: Carina 2.0, Celica 2.0 GTi 16V

ALTERNATOR / ALTERNATOR:

NIPPON DENSO: 100211-1070, 100211-1100, 100211-3120, 100211-7230, 100211-7640, 100211-7780, 100211-7910, 100211-7950, 100211-7951, 100211-7952, 100211-7990, 100211-9890, 101211-0100, 101211-0160, 101211-0420, 100211-0510, 121000-2500, 121000-2660

NIPPON DENSO
GA1254

FEATURES / CARACTERÍSTICAS: 95A, Diodes 8x50A

REPLACES / REEMPLAZA:

NIPPON DENSO: 0215803640, 0215804120, 0215804490, 0215804660, 0215804840, 2735774120, 2735774290; **Cargo:** 135417;

WAI/Transpo: INR403P

APPLICATION / APLICACIÓN:

TOYOTA: Celica, Carina;

VOLVO: 740, 940, 960

ALTERNATOR / ALTERNATOR:

NIPPON DENSO: 100211-8370, 100211-8371, 100211-8590, 121000-3000, 121000-3100, 121000-3300, 121000-3310, 121000-3330, 121000-3340, 121000-3360, 121000-3370, 121000-3380, 121000-3390, 121000-3400, 121000-3430, 121000-3440, 121000-3450, 121000-3452

NIPPON DENSO
GA1153 // NEW //

FEATURES / CARACTERÍSTICAS: 100A, 12x50A, B+: M6X32.2mm, External Diameter: 117MM

REPLACES / REEMPLAZA:

Transpo: INR428, INR428AL

APPLICATION / APLICACIÓN:

ACURA: ILX L4 2.4 2013>2015, RDX L4 2.3 2007>2012;

HONDA: Civic L4 2.4 2012>2015, CR-V L4 2.4 2012>2014, CR-V 2.4 Non-Turbo Gas 2012>2013

ALTERNATOR / ALTERNATOR:

DENSO: 104210-1530, 104210-4730, 104210-4731, 104210-4732, 104210-5160

NIPPON DENSO
GA1200 // NEW //

FEATURES / CARACTERÍSTICAS: 180A, Avalanche Diode, 12x50A, B+ M8X15.2mm, External diameter: 134mm

REPLACES / REEMPLAZA:

Mobiletron: RN-67; **Regitar:** RN-67; **AS-Poland:** ARC6066; **Era:** 216316; **Transpo:** INR440

APPLICATION / APLICACIÓN:

BMW: 535i L6 3.0 2010>2012, 535i GT L6 3.0L 2010>2012, 535i GT xDrive L6 3.0L 2011>2012, 535i xDrive L6 3.0L 2011>2012, 535Li 3.0L Turbo 2011>2012, 640i L6 3.0L 2012, X3 L6 3.0L 2012, X5 L6 3.0L 2012, X6 L6 3.0L 2012;

CHRYSLER: Grand Voyager V 2.8 2012;

DODGE: Nitro ENR 2.8 2007>2010;

FORD: F-150 V8 5.0L 2011>2014;

JEEP: Grand Cherokee V6 3.0L 2014>2018, Grand Cherokee I 3.0L CRD 2011>2015;

LEXUS: LS460 V8 4.6L 2007>2012;

TOYOTA: Land Cruiser V8 5.7L 2008>2011, Land Cruiser V8 5.7L 2013>2016, Sequoia V8 4.6L 2010>2012, Sequoia V8 5.7L 2008>2018

ALTERNATOR / ALTERNATOR:

DENSO: 104210-6070, 104210-6071, 104210-6072, 104210-6080, 104210-6130, 104210-6131, 104210-6140, 104210-6180, 104210-6181, 104210-6182, 104210-6220, 104210-6270, 104210-6340, 104210-6402, 104210-6490, 104210-6590, 104210-6591, 104210-6592, 104210-6670, 421000-7001, TN104210-6670; **CHRYSLER:** 04801338AB, 04801835AB, 04801835AC, 1270259, 4801313AB, 4801313AC, 4801835AB, 4801835AC, P04801835AB, P04801835AC; **JEEP EAGLE:** 1270259; **LEXUS:** 27060-38040, 27060-38041, 27060-38050, 27060-38070

NIPPON DENSO
GA1255

FEATURES / CARACTERÍSTICAS: 90A, 8x35A Bosch Press-fit standard diodes

REPLACES / REEMPLAZA:

...

APPLICATION / APLICACIÓN:

TOYOTA: Camry 2.2L 70A, Celica 2.2L 70A, MR2, Paseo W/O Heatshield;

LIFAN: Modelos 320/620 2010>

ALTERNATOR / ALTERNATOR:

DENSO: 1002115020, 1002116390, 1002116440, 1002115110, 1002116460, 100211644;

LIFAN: 481-3701100A, 1FZ198

VOLTAGE REGULATOR:

GA820

NIPPON DENSO
GA1258 // NEW //

FEATURES / CARACTERÍSTICAS: 120A, 8x50A, B+: M6X21.7mm, External Diameter: 114mm

REPLACES / REEMPLAZA:

Denso: 021580-5740; **Toyota:** 27357-70450; **Cargo:** 236947; **AS-Poland:** ARC6065; **Transpo:** INR574

APPLICATION / APLICACIÓN:

TOYOTA: Rav4 2.0 2001>2003, Rav 4 Mk2 2000>2003, Avensis T22 2000 2000>2003, Avensis Verso 2000 2001>2006

ALTERNATOR / ALTERNATOR:

DENSO: 101211-7400, 102211-0750, 102211-0840, 9661219-740;

TOYOTA: 27060-20200, 27060-20200-84, 27060-28070, 27060-28080, 27060-28080-84, 27060-28090-84

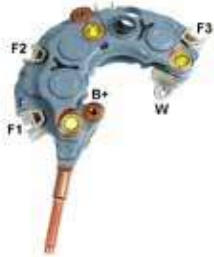
NIPPON DENSO
GA1260 // NEW //

FEATURES / CARACTERÍSTICAS: 80A, 6x35 Avalanche Diode, B+: M6X16.0mm

REPLACES / REEMPLAZA:

Cargo: 239026; **Transpo:** INR406P; **Mobiletron:** RN-36; **Regitar:** RN-36

APPLICATION / APLICACIÓN:

PONTIAC: Vibe L4 1.8L 2003>2006; **SCION:** tC L4 2.5L 2011>2012; **SUZUKI:** Aerio L4 2.3L 2005>2007; **TOYOTA:** Corolla L4 1.8L 2003>2008, Matrix L4 1.8L 2003>2008

ALTERNATOR / ALTERNATOR:

CHEVROLET: 88969480, 88969482; **SCION:** 27060-36011; **SUZUKI:** 31400-59J00; **TOYOTA:** 27060-0D110, 27060-0D110-84, 27060-0H010, 27060-0H01084, 27060-21150, 27060-21151, 27060-22020, 27060-22030, 27060-22040, 27060-22040-84, 27060-22080, 27060-22090, 27060-28170, 27060-28170-84, 27060-30050, 27060-75310, 27060-75310-84, 27060-75410, 27060-75411, 27060-75411-84, 27060-75412, 27060-75490, 270602203084, 270603001084, 270603005084

NIPPON DENSO
GA1304

FEATURES / CARACTERÍSTICAS: 120A Diodes 7x50A Avalanche (Zener), B+ Post M8

REPLACES / REEMPLAZA:

Denso: RTF40172; **Regitar:** RN-37; **WAI/Transpo:** INR431

APPLICATION / APLICACIÓN:

FORD: New Focus TDCi / 2.0

ALTERNATOR / ALTERNATOR:

NIPPON DENSO: 104210-3513, 104210-5800

VOLTAGE REGULATOR:

GA130

NIPPON DENSO
GA1305

FEATURES / CARACTERÍSTICAS: 120A Diodes 12x35A Avalanche (Zener), B+ Post M8

REPLACES / REEMPLAZA:

Denso: RTF39240, 021580-6830; **Regitar:** RN-54; **WAI/Transpo:** INR436

APPLICATION / APLICACIÓN:

HONDA: Acura

ALTERNATOR / ALTERNATOR:

NIPPON DENSO: 104210-2160, 104210-2870, 104210-4220, 104210-4370, 104210-5390, 104210-5410, 104210-5640, 104210-5990

NIPPON DENSO
GA1308

FEATURES / CARACTERÍSTICAS: 120A, Avalanche Diode 6-50A, Diameter OD: 113mm B+ M6x33mm

REPLACES / REEMPLAZA:

Cargo: 333441; **AS Poland:** ARC6064, **Mobiletron:** RN-45H, **Regitar:** RN-45H, **WAI Transpo:** INR438

APPLICATION / APLICACIÓN:

TOYOTA: Hilux Pit Bull

HONDA: Acura 2001>2004

ALTERNATOR / ALTERNATOR:

DENSO: 104210309; **HONDA:** 31100PGKA01, 31100PGKA03, TG1042109010

VOLTAGE REGULATOR:

GA141

NIPPON DENSO
GA1314

FEATURES / CARACTERÍSTICAS: 140A, 12X50A Avalanche, M8x30 B+ Bolt, Ø117mm
REPLACES / REEMPLAZA:
Cargo: 237607
APPLICATION / APLICACIÓN:
FORD: Focus II 1.6 /2.0 TDCi engine
ALTERNATOR / ALTERNATOR:
DENSO: 1042102710, 1042102730, 1042102780, 1042103520, 1042103521, 1042103522, 1042103523

NIPPON DENSO
GA1315

FEATURES / CARACTERÍSTICAS: 120A, Diodos 6-50A Avalanche(20-24V) Diameter OD: 117mm B+ M6mm.
REPLACES / REEMPLAZA:
Denso: 0215806490; **Regitar:** RN-48; **Cargo:** 237648; **WAI/Transpo:** INR429
APPLICATION / APLICACIÓN:
HONDA: Accord 2.4 2004-2005, Acura TSX 2.4 2004-2005, Element 2003-2006
ALTERNATOR / ALTERNATOR:
DENSO: 104210329, 1042103291; **HONDA:** 31100RAAA01, A03 A04 A05

POONG SUNG
GA1126

FEATURES / CARACTERÍSTICAS: 85A, Diodos 6x35A, with diode trio
REPLACES / REEMPLAZA:
Magneti Marelli: PR520565
APPLICATION / APLICACIÓN:
KIA: Besta 95>, Sportage
ALTERNATOR / ALTERNATOR:
POONG SUNG: OK 74 018 300 H.
VOLTAGE REGULATOR:
 GA125 / GA116

POONG SUNG
GA1127

FEATURES / CARACTERÍSTICAS: 60A, 6X50A Diodos
REPLACES / REEMPLAZA:
Hitachi: LR150-94B, LR150-98, LR150-98B, LR150-99, LR150-99B, LR150-101B, LR150-125, LR150-125B, LR150-140, LR150-165, LR150-177, LR150-186C, LR150-194, LR155-23, LR160-121, LR160-124, LR160-137, LR160-138, LR225-68B, LR225-80, LR235-58, LR235-62, LR235-69, LR235-70, LR240-21; **Lester:** 12278, 14255, 14300, 14301, 14303, 14587, 14647, 14652, 14659, 14742, 14744, 14745; **WAI:** 1-1096-01HI, 1-1109-01HI, 1-1114-01HI, 1-1124-01HI, 1-1567-01HI, 1-1593-01HI, 1-1593-02HI
APPLICATION / APLICACIÓN:
NISSAN; SUBARU (1978-1994)
ALTERNATOR / ALTERNATOR:
 ...

POONG SUNG
GA1133 // NEW //

FEATURES / CARACTERÍSTICAS: 120A, Avalanche Diodos 8x35A, M8x42.5mm, with triodiode and capacitor
REPLACES / REEMPLAZA:
Poongsung: 1109-026RS; **Transpo:** IHR788
APPLICATION / APLICACIÓN:
HYUNDAI: Elantra 2000 2002>2004, Santa Fé 2000 2001>2010, Trajet 2000 2001>2007, Tucson 2000 2004>2010;
KIA: Carens 2000 2002>2006, Sportage 2000 2004>2010
ALTERNATOR / ALTERNATOR:
HYUNDAI / KIA: 37300-27010, 37300-27012, 37300-27020, 37300-27021, 37300-27030, 37300-27031; **MAGNETI MARELLI:** 063532622010, 063532622010; **POONGSUNG:** 02131-9110, 02131-9111, 02131-9112, 02131-9261, 02131-9262, 02131-9310
VOLTAGE REGULATOR:
 GA589

POONG SUNG
GA1134

FEATURES / CARACTERÍSTICAS: 90A, Diodos 6x35A, with triodiode. Diameter 111mm, Right position positive
REPLACES / REEMPLAZA:
 -
APPLICATION / APLICACIÓN:
KIA: Sportage, Tucson 95>
ALTERNATOR / ALTERNATOR:
 -

POONG SUNG
GA1135

FEATURES / CARACTERÍSTICAS: 100A, Diodes 6x50A, with triodiode, Diameter 118mm

REPLACES / REEMPLAZA:

-

APPLICATION / APLICACIÓN:

KIA: Besta, Bongo

ALTERNATOR / ALTERNATOR:

-

VOLTAGE REGULATOR:

GA126

POONG SUNG
GA1136 // NEW //

FEATURES / CARACTERÍSTICAS: 120A, Diodes 8x50A, B+: M8X39.6mm, External diameter: 117mm

REPLACES / REEMPLAZA:

Cargo: 235599; **AS-Poland:** ARC9048; **Transpo:** IHR789; **Mobiletron:** RK-04; **Regitar:** RK-04; **Era:** 216332

APPLICATION / APLICACIÓN:

HYUNDAI: Elantra Mk3 hatch/saloon 2.0 CRDi 2001>2006, Highway Van 2.0 CRDi 2001>2004, Santa Fé 2.0 CRDi 4x4 2001>2006, Santa Fé 2.2 CRDi 4x4 2006>2012, Trajet 2.0 CRDi 2001>2008, Tucson 2.0 CRDi 2004>2010;

KIA: Carens Mk2 2.0 CRDi 2002->, Sportage 2.0 CRDi 2004->

ALTERNATOR / ALTERNATOR:

HYUNDAI / KIA: 37300-27010, 37300-27011, 37300-27012, 37300-27013, 37300-27030, 37300-27031;

POONG SUNG: 02131-9110, 02131-9111, 02131-9112, 02131-9113, 02131-9310, 02131-9311

PRESTOLITE
GA1596

FEATURES / CARACTERÍSTICAS: 90A, 8X35A Avalanche Diodes, with triodiode

REPLACES / REEMPLAZA:

Prestolite: K01208, K01422, 35215197.

APPLICATION / APLICACIÓN:

VW: Gol, Parati, Saveiro, Santana, Voyage 1998> (Autolatina)

ALTERNATOR / ALTERNATOR:

PRESTOLITE: 4335D, 4380D, 4410D, 4540C, 4555B, 4565B, 4575B, 4830D, 35214185A, 35214525B, 35214530C.

VOLTAGE REGULATOR:

GA596

PRESTOLITE
GA1597

FEATURES / CARACTERÍSTICAS: 90A, 8X35A Avalanche Diodes, without triodiode

REPLACES / REEMPLAZA:

Prestolite: K01382; **Lucas:** 35214586

APPLICATION / APLICACIÓN:

RENAULT: Clio, R19

ALTERNATOR / ALTERNATOR:

PRESTOLITE: 35214420, 35214420A.

VOLTAGE REGULATOR:

GA897

PRESTOLITE
GA1604

FEATURES / CARACTERÍSTICAS: 8x35A press-fit avalanche diodes

REPLACES / REEMPLAZA:

-

APPLICATION / APLICACIÓN:

VALDAY: Russian Truck

ALTERNATOR / ALTERNATOR:

Agrale: 6025.001.175.00.0;

Prestolite: AVE 2119 E;

Cummins: 5263830 - 5263797

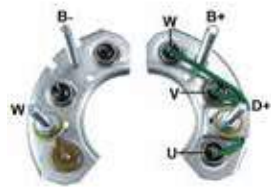
THERMOKING
GA1593

FEATURES / CARACTERÍSTICAS: 23A, 6x35A, B+: 1/4"X35mm P.S: Bolt D+ 3/16"X28mm, Bolt D- 3/16"X32mm, Bolt W- 3/16"X36mm
REPLACES / REEMPLAZA:

Motorola: 1-103, 1-113, 1-148, 1-150, 1-175, 1-18, 1-193, 1-47, 1-48, 1-49, 1-163, 1-164, 1-100, 1-130, 1-73, 1-94

APPLICATION / APLICACIÓN:

THERMO KING TRAILER UNIT: HK, HK-II, HK-III TK 2.49 Diesel 0000, SB-III Isuzu 2.0/2.2 Diesel 0000, Sentry Isuzu 2.2L Dsl 0000, Super II MAX Isuzu 2.2L Dsl 0000, TD-II Yanmar 388 Diesel 0000;

THERMO KING TRUCK UNIT: KD-II Yanmar 366 Diesel 0000, KD-II MAX Yanmar 366 Diesel 0000, KD-II SR Yanmar 374 Diesel 0000, MD-200 Yanmar 374 Diesel 0000, MD-200-MT Yanmar 374 Diesel 0000, MD-300 Yanmar 374 Diesel 0000, MD-II Yanmar 366 Diesel 0000, MD-II MAX Yanmar 374 Diesel 0000, MD-II MAX SR Yanmar 374 Diesel 0000, MD-II SR Yanmar 374 Diesel 0000, MD-II TCI Yanmar 366 Diesel 0000, RD-II Yanmar 388 Diesel 0000, RD-II MAX Yanmar 388 Diesel 0000, RD-II MAX SR Yanmar 388 Diesel 0000, TS-200 Yanmar 374 Diesel 0000, TS-300 Yanmar 374 Diesel 0000, TS-500 Yanmar 395 Diesel 0000, TS-600 Yanmar 395 Diesel 0000 XDS 0000

ALTERNATOR / ALTERNATOR:

Thermoking: 5D44463G01, 412194;

Motorola: 8MR2215D

VOLTAGE REGULATOR:

GA605

THERMOKING
GA1594

FEATURES / CARACTERÍSTICAS: 37A, 6x35A Avalanche Diode, B+: M6X23mm, Bolt: B- M5X15mm
REPLACES / REEMPLAZA:

APPLICATION / APLICACIÓN:

THERMO KING MISC. EQUIPMENT: Super II 30 / MAX Thermo King 2.2L 1991>2003

THERMO KING TRAILER UNIT: SB-190 Isuzu 2.2L 1999, SB-200 Yanmar 486 Diesel 1999, SB-200 30 Yanmar TK486 1999>2007, SB-300 Yanmar 486 Diesel 1999, SB-II Isuzu 2.0L Diesel 1991, SB-II MAX Isuzu 2.2L Dsl 1991, SB-III 30 Thermo King 2.2L Dsl. 1991>2003, Super II Isuzu 2.2L Dsl 1991, Super II TC Yanmar 486 Diesel 1999

ALTERNATOR / ALTERNATOR:

Thermo King: 1E32215901, 1E32215G01, 1E51760G01, 41-6780, 41-7912, 41-5458, 44-9571, 44-8950; **Prestolite:** 66021606

VOLTAGE REGULATOR:

GA607

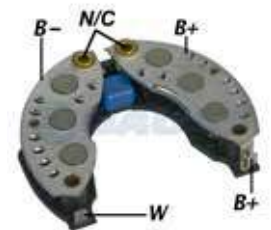
VALEO
GA1450

FEATURES / CARACTERÍSTICAS: 85A, Diodes 6x35A, with capacitor

REPLACES / REEMPLAZA:

Valeo Paris Rhone: 100157; **Valeo:** NC133, NC216; **Regitar:** RP-03; **Cargo:** 131164; **WAI/Transpo:** IPR157

APPLICATION / APLICACIÓN:

RENAULT: Alliance, 1.8i Fuego, Espace 2.1 td, R21 td, GTD, R25 Turbo d, DX R20 td, GTD, R19 1.8i ;

PEUGEOT;

EAGLE;

ALTERNATOR / ALTERNATOR:

PARIS RHONE: A13N18432737, A13N19432736, A13N106432716, A13N113432734, A13N114432726, A13N116180576, A13N120433042, A13N173433121, A13R258101988, A14N1100108, A14N2100151, A14N 9100483, A14N10101473, A14N22101111, A14N35432781, A14N36432782 A14N42102963, A14N51432785, A14N55104084, A14N56106843, A14N59102592, A14N60105118, A14N63432789, A14N65104643, A14N77432802, A14N82105763, A14N84105764, A14N4150433132, 71651802, 71651902, 71635102, 71635602, 71635902, 71636102, 71652402, 71652602, 71650002, 71650402, 71650802, 71770102, 71770202

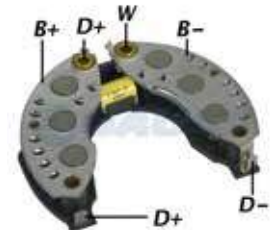
VALEO
GA1451

FEATURES / CARACTERÍSTICAS: 85A, Diodes 6x35A, with diode trio and capacitor

REPLACES / REEMPLAZA:

Valeo Paris Rhone: 103556, 103551, 181155; **Valeo:** A523726A, NC 135, NC 730, 593188, 593195, 593199; **Cargo:** 131701;

Lucas: 21225389, UBB 235, UBB255; **Magneti Marelli:** 940 038 305; **Regitar:** RP-02; **WAI/Transpo:** IPR551

APPLICATION / APLICACIÓN:

VOLVO: Penta;

PEUGEOT;

RENAULT: Espace 2.1 td , R21 td, GTD, R25 turbo d, DX R20 td, GTD, R19 1.8i

ALTERNATOR / ALTERNATOR:

VALEO: A12N2M, A13N1M100605, A13N2M100606, 208121, 208124, 208399, 204401, 208402, 100605, 100606, 100879, 101218, 101822, 101823, 102341, 102794, 103141, 2102341, 2102794, 2181693, 2181695, 2181757, 2181760, 2181762, 2541133, 2541191, 2541199, 2541208, 2541218, 2541768, 2541773, 436352, 592769, 592775, A13N28M102794, A13N33M103233, A13N34104551, A13N35M103141, A13N35M103141, A13N36M100879, A13N5101823, A14N118M181991, A14N119M180620, A14N122N2518061, A14N137M592775, A13N165, A13N186M, A13N190, A13N281, A13N282, A14N114T, A14N115M, A14N116M, A14N137, A14N177M, A14N206M, A14N43M, A14N44M

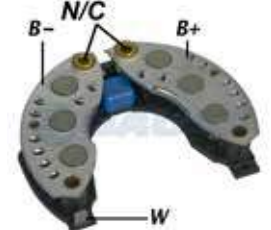
VALEO
GA1452

FEATURES / CARACTERÍSTICAS: 120A, Diodes 6x50A, with capacitor

REPLACES / REEMPLAZA:

Valeo: 100175, 101217, 101759, 103539, 103570, 103576, 104292, 105135, 105629, NC139, NC936; **Cargo:** 133689;

Lucas: 21225388; **Magneti Marelli:** 940 038 309; **Regitar:** RP-03; **WAI/Transpo:** IPR539

APPLICATION / APLICACIÓN:

AMC; RENAULT: R18 R20, Trafic, Fuego, RM, R9 GTX, Espace 2.0;

PEUGEOT: 204, 304, 504, 604, J7

ALTERNATOR / ALTERNATOR:

VALEO: 100108, 2105311, 432716, A13N62, 100151, 2105369, 432724, A13N82, 100483, 2105448, 432726, A13N84, 100735, 2105626, 432736, A13N87, 101111, 2105654, 432738, A13N91, 101373, 2105678, 432757, A13N92, 101473, 2105763, 432781, A13NN82, 101728, 2105764, 432782, A13R258, 101988, 2106073, 432785, A14N1, 102592, 2180576, 432789, A14N10, 102963, 2180579, 432793, A14N101, 104084, 2180594, 432802, A14N102, 104643, 2180674, 432812, A14N103, 105118, 2180788, 433449, A14N113, 105243, 2180789, 433450

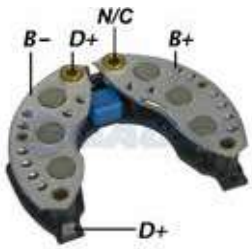
VALEO
GA1453

FEATURES / CARACTERÍSTICAS: 120A, Diodes 6x50A, with diode trio, capacitor and resistor

REPLACES / REEMPLAZA:
Valeo: 105554, 2181241, NC245; **Lucas:** 21225378, UBB 242; **Peugeot:** 5744.61; **Regitar:** RP-04HR; **Cargo:** 131569;

WAI/Transpo: IPR554

APPLICATION / APLICACIÓN:
PEUGEOT: Peugeot 505, 204, 304, 305, 104, J5 1.8, 2.0, J9, 604;

CITROËN: AX 1.0, 1.3, 1.4, BX14, C15 1.1, 1.4, C25 0.8, 2.0;

TALBOT: Tagora DT d

ALTERNATOR / ALTERNATOR:
VALEO: A13N130, 2180675, 100749, A14N82, 432806, 2100749, A14N88, 436314, 2105707, 436320, 2106074; **LESTER:** 14455

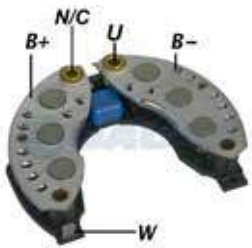
VALEO
GA1454

FEATURES / CARACTERÍSTICAS: 120A Diodes 6x50A, without diode trio, with capacitor

REPLACES / REEMPLAZA:
Valeo Paris Rhone: 104615, 105522, 105523, 106016; **Valeo:** NC143; **Cargo:** 131573; **Lucas:** 21225390, UBB 238;

Magneti Marelli: 940 038 308; **Regitar:** RP-08; **WAI/Transpo:** IPR615

APPLICATION / APLICACIÓN:
JEEP: Diesel with engine Renault;

VOLVO: 460 1.9TD;

RENAULT: Master 2.0, Trafic, R19, 1.9 td, TDE R20, R21 Baccara, RX, GTX, TI, TXE Aut, R25 Clio 1.9D, Espace 2.0, GTS, TSE, TXE, 2.1 td, Fuego td

ALTERNATOR / ALTERNATOR:
VALEO: 104247, A13N107, A13N81, 104248, A13N108, A13N90, 104252, A13N112, A14N117, 180577, A13N117, A14N132, 180580, A13N119, A14N152, 183011, A13N164, A14N158, 432717, A13N185, A14N163, 432718, A14N54, A14N164, 432783, A14N53, A14N4;

LESTER: 14308, 14891, 14978; **PIC:** 208126, 208127, 208128, 208129

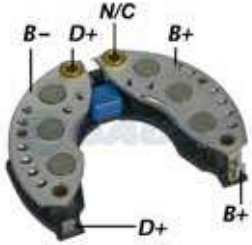
VALEO
GA1455

FEATURES / CARACTERÍSTICAS: 120A, Diodes 6x50A, with diode trio and capacitor, without resistor

REPLACES / REEMPLAZA:
Valeo Paris Rhone: 101713; **Cargo:** 133687; **Lucas:** 21225394, UBB 234; **Magneti Marelli:** 940 038 304; **Regitar:** RP-05H;

WAI/Transpo: IPR713

APPLICATION / APLICACIÓN:
PORSCHE: 911 Carrera, Turbo, 928 4.5, 4.7

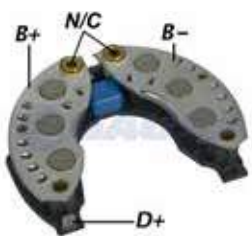
ALTERNATOR / ALTERNATOR:
VALEO: 2101368, 432776, A14N38, 2102746, 432797, A14N38, 2104355, A14N11, A14N71; **LESTER:** 208400

VALEO
GA1456

FEATURES / CARACTERÍSTICAS: 120A, Diodes 6x50A, with diode trio and capacitor

REPLACES / REEMPLAZA:
Valeo Paris Rhone: 592747, 592749, NC976; **Cargo:** 34098; **Magneti Marelli:** 940 038 330; **Regitar:** RP-09; **WAI/Transpo:** IPR747

APPLICATION / APLICACIÓN:
PEUGEOT: 205 1.6, 1.8, 1.9 GTI, 305, 309 1.6, 1.8, 1.9 GTI 16V, 405 1.6, 1.9 GR, GLX, SRI;

CITROËN: BX16, BX19d, Visa 1.7d, Visa 1.7d, Visa GTI, C15 1.8d;

TALBOT: Horizon d

ALTERNATOR / ALTERNATOR:
VALEO: 433457, A13N182, A13N218, A13N151, A13N183, A13N219, A13N177, A13N183, A13N219, A13N181, A13N218, A13N261, A13N181, A13N182

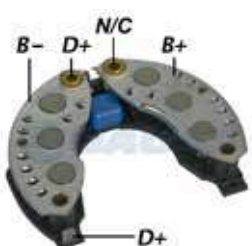
VALEO
GA1457

FEATURES / CARACTERÍSTICAS: 120A, Diodes 6x50A, with diode trio, capacitor and resistor

REPLACES / REEMPLAZA:
Valeo Paris Rhone: 101773, 101776, 103546; **Cargo:** 131569; **Lucas:** 21225391; **Valeo:** NC 134, NC 217; **Regitar:** RP-04R;

WAI/Transpo: IPR773

APPLICATION / APLICACIÓN:
PEUGEOT: 204, 304, 305, 104, 504, 604;

RENAULT: R14, TL;

CITROËN: Visa GT, C15 1.0, 1.1, 1.4

ALTERNATOR / ALTERNATOR:
VALEO: 100402, 433380, 71653202, A13R259, 101989, 71635702, 71655002, A13R266, 102240, 71636202, 71655102, A13R268, 102242, 71636302, 71770002, 432803, 102243, 71636402, 9860309912, 432815, 104378, 71636802, A13N32, 433374, 105114, 71636902, A13N38, A13N94, 432739, 71651502, A13N40, A13R248, 432743, 71652002, A13N41, 71652703, 432744, 71652102, A13N42, 71653102, 432745, 71652302, A13N56M, 432758, 432746, 71652702, A13N83, 432768; **LESTER:** 14954

VALEO
GA1458

FEATURES / CARACTERÍSTICAS: 120A, Diodes 6x50A, with diode trio, capacitor and resistor

REPLACES / REEMPLAZA:

Valeo Paris Rhone: 105813, 105814, 592742, NC142; **Cargo:** 133741; **Lucas:** 21225379, UBB 244; **Peugeot:** 5744.65;

Regitar: RP-09; **WAI/Transpo:** IPR813

APPLICATION / APLICACIÓN:

PEUGEOT: 205 1.6 GTi, 1.8, 1.9 GTi, 305d, GT, GX, 309 1.6, 1.8, 1.9, 405 1.6, 1.9d;

TALBOT: Horizon;

CITROËN: BX16, BX19, Visa17, C15 1.8d

ALTERNATOR / ALTERNATOR:

VALEO: 2101846, 432769, 433487, A13N243, 2105761, 432778, A13N167, A13N80, 2541142, A13N214, A13N95; **LESTER:** 14584

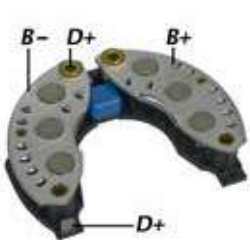
VALEO
GA1459

FEATURES / CARACTERÍSTICAS: 120A, Diodes 6x50A, with diode trio, without capacitor

REPLACES / REEMPLAZA:

Valeo Paris Rhone: 350011, NC388; **Lucas:** 21224163; **Cargo:** 131569; **WAI/Transpo:** IPR103

APPLICATION / APLICACIÓN:

RENAULT

ALTERNATOR / ALTERNATOR:

VALEO: 71635202, 71645002, 71651602, 71635502, 71650202, 71652202, 71635802, 71651202, 71655502, 71636002, 71651302;

PIC: 208606, 208609

VALEO
GA1460

FEATURES / CARACTERÍSTICAS: 120A, Diodes 6x50A, with capacitor

REPLACES / REEMPLAZA:

Valeo Paris Rhone: 101743, 102527, 103543, 105380, A103543A, A180593A, NC 145; **Cargo:** 131228; **Lucas:** 21225386, UBB 232;

Magneti Marelli: 940 038 301; **Volvo:** 33431263; **Regitar:** RP-01; **WAI/Transpo:** IPR135

APPLICATION / APLICACIÓN:

RENAULT: Clio, 1.1, R19 1.2, R5 1.0, 1.1, 1.2, 1.4 GT Turbo, R9, R11, R18 GTX, Master 2.0, Tfraic, Fuego TL, Clio 1.8, 1.9;

VOLVO: 640 Série

ALTERNATOR / ALTERNATOR:

VALEO: 100791, 2181467, 432771, A13N188, 101358, 2181468, 432777, A13N199, 101731, 2181648, 432795, A13N204, 101748, 2181726, 432796, A13N206, 101999, 2181727, 432799, A13N209, 102746, 2181730, 432805, A13N210, 103586, 2518059, 432814, A13N226, 104667, 2518086, 433441, A13N27, 104840, 2541116, 433443, A13N271, 105789, 2541117, 433452, A13N29, 106085, 2541118, 433459, A13N30, 180505, 2541120, 433460, A13N49, 181730, 2541121, 433461, A13N50, 2100790, 2541122, 433464, A13N52, 2100791, 2541123

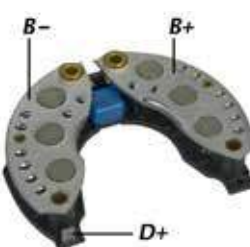
VALEO
GA1461

FEATURES / CARACTERÍSTICAS: 120A, Diodes 6x50A, with diode trio and capacitor

REPLACES / REEMPLAZA:

Valeo Paris Rhone: 100931, 104941, 104971; **Valeo:** 592596, NC138; **Cargo:** 131164; **Lucas:** 21225400, UBB 240;

Magneti Marelli: 940 038 302; **Regitar:** RP-04; **WAI/Transpo:** IPR203

APPLICATION / APLICACIÓN:

CITROËN: C32, 35 2.0, 2.2, 2.5, C15 1.1, 1.3, CX 2000, 2200, 2400 GTI, CX25;

PEUGEOT: 309 1.1, 1.3, 1.4, 1.6;

RENAULT: R19, R17, R11 GTX, R9 GTX;

VOLVO: 440, 460 1.7 Turbo, 1.6, 1.8, 2.0, 480S 2.0

ALTERNATOR / ALTERNATOR:

VALEO: 180707, 71655002, A13N46, A14N78, 2100702, 71655102, A13N47, A14N80, 432719, 71655202, A13N9, A14N88, 432737, A13N109, A13R267, A14N90, 432747, A13N129, A14N07, A14N93, 432748, A13N242, A14N16, A14N97, 432811, A13N25, A14N23, A14R47, 71636202, A13N39, A14N23, **PIC:** 208116, 208117, 208118, 208123, 208130, 208131, 208600, 208600A, 208601, 208607; **LESTER:** 13090, 14039, 14224, 14263, 14281, 14291, 14320, 14609, 14942, 14955

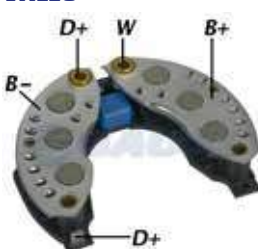
VALEO
GA1462

FEATURES / CARACTERÍSTICAS: 120A, Diodes 6x50A, with diode trio and capacitor

REPLACES / REEMPLAZA:

Valeo Paris Rhone: 101227, 104269; **Valeo:** NC137; **Cargo:** 131568; **Lucas:** 21225416, UBB 236;

Magneti Marelli: 940 038 306; **Regitar:** RP-06H; **WAI/Transpo:** IPR227

APPLICATION / APLICACIÓN:

SCANIA;

PEGASO

ALTERNATOR / ALTERNATOR:

VALEO: 100422, 2102334, 592774, A13N45T, 102334, 2105111, 99755, A14N133, 105111, 2105112, A13N11, A14N135, 105112, 2541145, A13N245, A14N39, 2099755, 2541147, A13N44T, A14R33, 2100442; **PIC:** 208135; **LESTER:** 12120

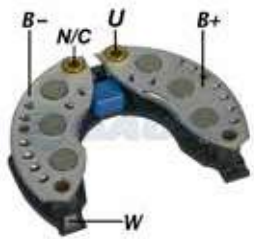
VALEO
GA1463

FEATURES / CARACTERÍSTICAS: 120A , Diodes 6x50A, with capacitor

REPLACES / REEMPLAZA:
Valeo Paris Rhone: 105252, 105690; **Valeo:** NC141, A523707A, A523724A; **Cargo:** 132985; **Lucas:** 21225387, UBB 237; **Magneti Marelli:** 940 038 307; **Regitar:** RP-07; **WAI/Transpo:** IPR252

APPLICATION / APLICACIÓN:
RENAULT: Space 2.1td, R19 1.8i, R20td, GTD, R21 Baccara, TXE, EX, GTX, TI, GTD, R25

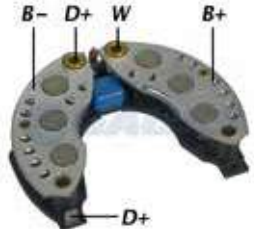
ALTERNATOR / ALTERNATOR:
VALEO: 432764, A13N88, A13N171, 432788, A14N62, A13N171

VALEO
GA1464

FEATURES / CARACTERÍSTICAS: 120A, Diodes 6x50A, with diode trio, capacitor and resistor

REPLACES / REEMPLAZA:
Valeo Paris Rhone: 101342; **Valeo:** NC161, A523728A; **Cargo:** 131570; **Lucas:** 21225377, UBB 243; **Magneti Marelli:** 940 038 311; **WAI/Transpo:** IPR342-1

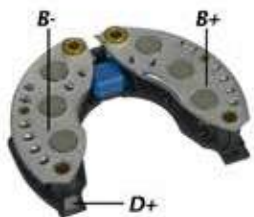
APPLICATION / APLICACIÓN:
RENAULT;
PEUGEOT
ALTERNATOR / ALTERNATOR:
VALEO: 100363, 2100363, 2541414, A13N61T, 100894, 2100894, A13N221, A14N18, 100896, 2100896, A13N229T, A14N28T, 101375, 2101375, A13N22T, A14N32T, 101879, 2101879, A13N4T, A14N3T, 102056, 2102056, A13N5T, A14N91, 102058, 2102058, A14N92

VALEO
GA1465 // NEW //

FEATURES / CARACTERÍSTICAS: 120A Diodes 6x50A, With triodiode, With Capacitor

REPLACES / REEMPLAZA:
Valeo Paris Rhone: 100931, 104941, 104971; **Valeo:** NC138, 592596; **Lucas:** 21225400, UBB 240; **Magneti Marelli:** 940 038 302; **Regitar:** RP-04, **Cargo:**131164, **Transpo:** IPR203

APPLICATION / APLICACIÓN:
CITROËN: C32 2.0, 2.2, 2.5, C35 2.0, 2.2, 2.5, C15 1.1, 1.3; **VOLVO:** 440i, 460, 480; **PEUGEOT:** 309 1.1, 1.3, 1.4, 1.6; **RENAULT:** R19, R21, R9, R11

ALTERNATOR / ALTERNATOR:
VALEO: 180707, 2100702, 432719, 432737, 432747, 432748, 432811, 71636202, 71655002, 71655102, 71655202, A13N109, A13N129, A13N242, A13N25, A13N39, A13N46, A13N47, A13N9, A13R267, A14N07, A14N16, A14N23, A14N23, A14N78, A14N80, A14N88, A14N90, A14N93, A14N97, A14R47; **LESTER:** 13090, 14039, 14224, 14263, 14281, 14291, 14320, 14609, 14942, 14955; **PIC:** 208116, 208117, 208118, 208123, 208130, 208131, 208600, 208600A, 208601, 208607

VALEO
GA1499 // NEW //

FEATURES / CARACTERÍSTICAS: 90A, 8x50A Avalanche, B+: M8X15.5mm, External diameter 108mm

REPLACES / REEMPLAZA:
Valeo: 593512; **Mobiletron:** RP-42; **Transpo:** IPR512; **AS-Poland:** ARC3044; **Era:** 216027; **Cargo:** 235558

APPLICATION / APLICACIÓN:
MERCEDES-BENZ: A160 1.7 CDI 2001>2015, A170 1.7 CDI 2001>2004, Vaneo 1.7 CDI 2002>2005

ALTERNATOR / ALTERNATOR:
VALEO: SG15L012, SG15L026

MB: A6681540102, A6681540202, A6681540302

VALEO
GA1611 // NEW //

FEATURES / CARACTERÍSTICAS: 220A, 6x50A Avalanche Diode, B+: M8x1,25x12.6mm

REPLACES / REEMPLAZA:

...

APPLICATION / APLICACIÓN:
BMW: 320d 1995ccm N47D20C, 2.0 2011-2016, 320d N47D20C 1995cc, 2.0L 2011-2016,5 (F10) Eng. 518 d 100kw 2013-2014, 5 (F10) Eng. 520 d 120kw 2009-2016, 5 (F10) Eng. 520 d xDrive 120kw 2013-2016, 5 (F10) Eng.N47 D20 C 518 d 105kw N47 D20 C 2013-2014, 5 (F10) Eng.N47 D20 C 520 d 135kw N47 D20 C 2010-2016, 5 (F10) Eng.N47 D20 C 520 d xDrive 135kw N47 D20 C 2013-2014, 5 (F10) Eng. N47 D20 D 525 d 155kw N47 D20 D 2011-2016, 5 (F10) Eng.N47 D20 D 525 d 160kw N47 D20 D 2011-2016, 5 (F10) Eng.N47 D20 D 525 d xDrive 155kw N47 D20 D 2011-2016, 5 (F10) Eng.N47 D20 D 525 d xDrive 160kw N47 D20 D 2011-2016, 5 Gran Turismo (F07) Eng. 520 d 120kw 2011, 5 Gran Turismo (F07) Eng.N47 D20 C 520 d 135kw N47 D20 C 2011, 5 Touring (F11) Eng. 518 d 100kw 2012, 5 Touring (F11) Eng. 520 d 120kw 2009, 5 Touring (F11) Eng. 520 d xDrive 120kw 2013, 5 Touring (F11) Eng. 525 d 155kw 2011, 5 Touring (F11) Eng. 525 d xDrive 155kw 2011, 5 Touring (F11) Eng.N47 D20 C 518 d 105kw N47 D20 C 2012-2014, 5 Touring (F11) Eng.N47 D20 C 520 d 135kw N47 D20 C 2009-2016, 5 Touring (F11) Eng.N47 D20 C 520 d xDrive 135kw N47 D20 C 2013-2014, 5 Touring (F11) Eng.N47 D20 D 525 d 160kw N47 D20 D 2011, 5 Touring (F11) Eng.N47 D20 D 525 d xDrive 160kw N47 D20 D 2011, 520d 1995ccm N47D20C, 2.0 2010-2016, 520d N47D20C 1995cc, 2.0L 2010-2016, 520d Gran Turismo N47D20C 1995cc, 2.0L 2010-2016, 525d 1995ccm N47D20, 2.0 2011-2016, 525d N47D20 1995cc, 2.0L 2011-2016, X3 (F25) Eng.N47 D20 C sDrive 18 d 100kw 2011-2016, X3 (F25) Eng.N47 D20 C sDrive 18 d 100kw N47 D20 C 2011, X3 (F25) Eng.N47 D20 C sDrive 18 d 105kw 2011-2016, X3 (F25) Eng.N47 D20 C sDrive 18 d 105kw N47 D20 C 2011, X3 (F25) Eng.N47 D20 C xDrive 20 d 120kw 2010-2016, X3 (F25) Eng.N47 D20 C xDrive 20 d 120kw N47 D20 C 2010, X3 (F25) Eng.N47 D20 C xDrive 20 d 135kw 2010-2016, X3 (F25) Eng.N47 D20 C xDrive 20 d 135kw N47 D20 C 2010, X3 sDrive 1995ccm N47D20C, 2.0 2011-2016, X3 xDrive 1995ccm N47D20C, 2.0 2010-2016

ALTERNATOR / ALTERNATOR:
VALEO: FG23S032, FG23S043, FG23S011, FG23S054, FG23S010;

BMW: 12-31-4-595-890, 12-31-4-595-891, 12-31-7-575-344, 12-31-7-575-347, 12-31-7-603-779, 12-31-7-603-782

VALEO
GA1612 // NEW //

FEATURES / CARACTERÍSTICAS: 120A, 6x35A Avalanche Diode, B+: M8x1,25x18.0 mm
REPLACES / REEMPLAZA:

...

APPLICATION / APLICACIÓN:

FORD: Ecosport 1.5 EcoBlue TDCi (XVJD) Diesel 2015>, Ecosport 1.5 TDCi Ecoblue (ZTJA / ZTJB / ZTJC) Diesel 2017>

ALTERNATOR / ALTERNATOR:

VALEO: FGN12S102. **FORD:** GN15-10300-AA

VALEO
GA1680 // NEW //

FEATURES / CARACTERÍSTICAS: 150A, 6x60A Avalanche Diode, B+: M8X14.5mm
REPLACES / REEMPLAZA:

...

APPLICATION / APLICACIÓN:

CITROËN: Berlingo 1.6 Vti 2009>2010, C4 Grand Picasso I 1.6 16V 2008, C4 Grand Picasso I 1.6 THP 2010, C4 II 1.6 Vti 2009, C5 III 1.6 THP 150 2010, DS3 Convertible 1.6 THP 150 2013>2015, DS4 Eng.5FS (EP6C) 1.6 VTi 120 2011>2015, DS5 1.6 THP 165 2012>2015

ALTERNATOR / ALTERNATOR:

VALEO: FG15T044, FG15T072, 2620249, TG12C170, 98 073 448 80

PEUGEOT: 9666998080, 9666997980

VALEO
GA1691 // NEW //

FEATURES / CARACTERÍSTICAS: 150A, 6x60A Avalanche Diode, B+: M8x1.25x10.8mm
REPLACES / REEMPLAZA:

...

APPLICATION / APLICACIÓN:

RENAULT: Fluence 2.0 16V 2010> Petrol, Laguna 2.0 16V 2007>2012 Petrol, Laguna 2.0 16V Hi-Flex 2007>2015 Petrol/Ethanol, Latitude 2.0 16V 2011> Petrol/Ethanol, Megane III Hatchback 2.0 2009> Petrol, Megane III Grandtour 2.0 2009> Petrol, Megane III Coupe 2.0 2009> Petrol, Megane CC 2.0 2010> Petrol, Scénic III 2.0 16V 2009> Petrol

ALTERNATOR / ALTERNATOR:

VALEO: TG15C153, TG150025, 2606190A, TG15C142;

RENAULT: 2310 005 43R, 8200 854 119

VALEO
GA1814

FEATURES / CARACTERÍSTICAS: 120A, 6x50A Avalanche Diode, B+: M8x16mm
REPLACES / REEMPLAZA:

...

APPLICATION / APLICACIÓN:

HYUNDAI: Creta 1.6 2017, Elantra Stufenheck 1.6 2011>2017, i30 1.6 GDI 2011>2017, i30 CW 1.6 2012>2017, Veloster 1.6 MPI 2011>2017;

KIA: Forte5 1.6 L4 2017, Soul 1.6 L4 2017

ALTERNATOR / ALTERNATOR:

HYUNDAI/ KIA: 37300-2B910; **VALEO:** 2625573, 2622971

VOLTAGE REGULATOR:

GA912

VALEO
GA1824

FEATURES / CARACTERÍSTICAS: 90A, 6x35A Avalanche Diode, Diameter: 108mm
REPLACES / REEMPLAZA:

Valeo: S9082PC

APPLICATION / APLICACIÓN:

GM: Corsa, Corsa Sedan 1.0/ 1.4/1.8/ 1.8 OHC, Meriva 1.8 OHC 2005>

ALTERNATOR / ALTERNATOR:

VALEO: SG9B081 /SG9B082

GM: 93312974 / 93312975 / 2220238A / 2220239A

VALEO
GA1827

FEATURES / CARACTERÍSTICAS:
REPLACES / REEMPLAZA:

...

APPLICATION / APLICACIÓN:

VW: Fox Blue Motion 2015>, Gol 2017>, Up 2014>, Voyage 2017> (All 1.0 3 cylinder)

ALTERNATOR / ALTERNATOR:

VALEO: TG9S132, TG12C213; **VW:** 04C 903 023 P;

RENAULT: 2622557

VOLTAGE REGULATOR:

GA980

VALEO
GA1829

FEATURES / CARACTERÍSTICAS: 150A, 6x50A Avalanche Diode, B+: M8X19mm

REPLACES / REEMPLAZA:

...

APPLICATION / APLICACIÓN:
MERCEDES BENZ: E200 1800 2002>2010

ALTERNATOR / ALTERNATOR:
VALEO: TG15C075;

MERCEDES BENZ: A 271 154 15 02

VOLTAGE REGULATOR:

GA919

VALEO
GA1844

FEATURES / CARACTERÍSTICAS: 120A, 8x50A, Avalanche Diode B+: M8x25.7mm

REPLACES / REEMPLAZA:
Cargo: 138303; **AS-Poland:** ARC3018; **Transpo:** IPR850; **Mobiletron:** RP-23; **Regitar:** RP-23

APPLICATION / APLICACIÓN:
BMW: Z3 L6 2.8L 2793cc 1997-2000

RENAULT: Clio II 1900 1998>2001, Espace III 2000 16v 1999>2002, Kangoo 1900 1999>2005, Megane 1900 1997>2000, Trafic 1900 1997>2000

VOLVO: C70 L5 2.3/2.4 1998>1999, S70 L5 2.3/2.4 1998, V70 L5 2.3/2.4 1998

OPEL: Movano 1900 2000>2002

ALTERNATOR / ALTERNATOR:
BMW: 12311432976, 12311432978, 12311432979, 12311432981, 12311432982, 12311432984

CHEVROLET: 4402600, 9112174

OPEL: 44-02-600

RENAULT: 7700105333, 7700300407, 7700300408, 7700427880, 7700430579, 7700431941

VOLVO: 8111107, 8111107-0, 8111920, 8251639, 9148301, 9148665

VALEO
GA1845

FEATURES / CARACTERÍSTICAS: 155A, Avalanche Diode 8x50A, B+: M8x32mm

REPLACES / REEMPLAZA:
Valeo: 593667; **Cargo:** 236305; **AS-Poland:** ARC3046; **Transpo:** IPR687; **Mobiletron:** RP-41; **Regitar:** RP-41

APPLICATION / APLICACIÓN:
RENAULT EUROPE CAR: Espace IV 1.9 2002>2006, Espace IV 2.0 Turbo 2002>2010, Espace IV 2.2 2002>2010, Grand Scenic II 1.9 2004>2010, Megane II 1.9 2002>2010, Scenic II 1.9 2004>2010

ALTERNATOR / ALTERNATOR:

Renault: 7711134926, 8200138269, 8200225806, 8200290220, 8200495268, 8200495269, 8200667616, 8200667617

VALEO
GA1846 // NEW //

FEATURES / CARACTERÍSTICAS: 150A, Avalanche Diode 12x50A, B+: M8x13.2mm, External diameter 102mm

REPLACES / REEMPLAZA:
Valeo: 2809019, 2809020, 593287, 593499; **Cargo:** 232199; **AS-Poland:** ARC3024; **Transpo:** MER1920

APPLICATION / APLICACIÓN:
CITROËN: Berlingo 2.0 Hdi 4x4 2002>2005, Berlingo box 2.0 Hdi 1999>2002, C5 2.2 Hdi 2001>2002, C5 break 2.0 Hdi 2001>2002, Evasion 2.0 Hdi 2000>2002, Jumper box 2.0/2.2 2001>2004, Xsara 2.0 Hdi 1999>2002, Xsara break 2.0 Hdi 1999>2002, Xsara coupe 2.0 Hdi 1999>2002

PEUGEOT: 406 1900 1996>1999, 406 2100 1996>1998, 605 2100 1995>1998

FIAT: Ducato box 2.0 2002>2004, Scudo box 2.0/2.0 16V 1999>2004, Ulysse 2.0 16V 1999>2002

ALTERNATOR / ALTERNATOR:
CITROËN/ PEUGEOT: 9624177680, 9639362380, 9641302580, 9645907680, 9645907780, 9624137480, 9624137680, 9635342080, 5705GC, 5702 A0 (P), 5702 A0 (P), 5702 A1 (C), 5702 A1 (C), 5702A0, 5702A0, 5702A1, 5702A1, 57054F, 57054S, 57055H, 57055J, 5705AA, 5705Y3, 5705Y4

FIAT: 9636254180, 9640878780

VALEO
GA1847 // NEW //
FEATURES / CARACTERÍSTICAS: 70A, 6x50A, External diameter 100mm

REPLACES / REEMPLAZA:
Cargo: 131698; **AS-Poland:** ARC3123; **Transpo:** MER106; **Mobiletron:** RT-07H; **Regitar:** RT-07H

APPLICATION / APLICACIÓN:
BMW: 320 w/ 2.0 1977>1982, 520 w/ 2.0 1977>1981

FIAT: Regata 138B 1.3/1.5 1983>1985, Regata 138C2 1.5 1985>1987, Regata 138C3 1.5 1985>1989, Ritmo 138B3 1.5 1985>1987, Uno 138C2 1.5 1985>1987

LANCIA: Delta 138C 1.5 1985>1987, Prisma 138C 1.5 1985>1986

CITROËN: C25 Box 2.5 1987>1994, CX 2000 1974>1980, CX 2200 1975>1980, CX 2500 1983>1990, CX I Break 2500 D 1982>1985, CX II 25 D Turbo 1985>1986

SAAB: 900 L4 2.0 1985 1979>1980

ALTERNATOR / ALTERNATOR:
BMW: 12311277232, 12311277502, 12311361373, 12311361824

FIAT: 46231688, 46231689, 77401410, 77525410, 9563261580

CITROËN: 5705 75, 5705 88, 5705 Y6 (C), 95607228 (C), 95607228 (C), 9563261580, 95635746

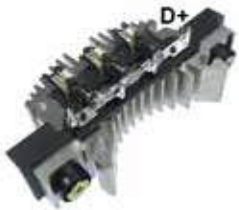
SAAB: 8512311, 8523254, 8557043

VALEO
GA1848
FEATURES / CARACTERÍSTICAS: 150A, 6x60A, Diodo Avalanche B+: M8x16.5mm

REPLACES / REEMPLAZA:
Valeo: 2606622, 593526, 593803; **Elccor:** ARC-PR055; **Cargo:** 235654; **As-Poland:** ARC3030; **Transpo:** MER548

APPLICATION / APLICACIÓN:
MERCEDES-BENZ: A160/ A180/ A200 2000 2004>2010, B180/ B200 2000 2005>2010

BMW: 318 2.0 2006>2015, 320 2.0 2006>2015, 325 3.0 2010, 325 3.0 2006>2009, 330 3.0 2005>2008, 335 3.0 2006>2015

CITROËN: Berlingo 2.0 4x4 2002>2005, C1 1.4 2005>2014, C3 1.4 2005>2006, C4 coupe 2.0 2006>2007, C5 II 2.2 2004, C8 2.2 2002, Xsara 1.4 2003>2005

PEUGEOT: 206 1600 2004>2010, 207 1400/ 1600 2006>2010, 307 1600/ 2000 2003>2010, 308 1600 2007>2012, 406 2000/ 2200 2001>2004, 407 1600/ 2000/ 2200 2004>2010, 607 2000/ 2200 2004>2010, 807 2000/ 2200 2002>2010

FIAT: Ulysse 2.0 2002>2011

ALTERNATOR / ALTERNATOR:
BMW: 12317799180, 12317799181

FIAT: 71748885, 9646065480, 9646066880, 9646321780

MERCEDES-BENZ: 6401540202, 6401540302, 6401540402, 6401540502, 6401540102, A6401540202, A6401540302, A6401540402, A6401540502, A6401540102

PEUGEOT/CITROËN: 5702 C5, 5702 C5 (P), 5702 C6, 5702 C6 (C), 5702 E2, 5702 E3 (C)

VALEO: TG15C020, TG15C022, TG15C023, TG15C028, TG15C034, TG15C053, TG15C054, TG15C056, TG15C057, TG15C057A, TG15C057B, TG15C057C, TG15C093, TG15C118, TG15C119, TG15C121, TG15C127, TG15C134, TG15C156

VALEO
GA1849 // NEW //
FEATURES / CARACTERÍSTICAS: 80A, 6x50A, B+: M8X15mm

REPLACES / REEMPLAZA:
Cargo: 235517; **AS-Poland:** ARC3124; **Mobiletron:** RP-39H; **Regitar:** RP-39H

APPLICATION / APLICACIÓN:
CITROËN: C2 1.1/1.4/1.6 2003->, C3 1.1/1.4/1.6 2002->, C3 Pluriel 1.4/1.6, Berlingo 1.4 2002>2005

PEUGEOT: 207 hatch 1.4/1.6 16V 2006->, 307 hatch 1.4/1.6 2000>2007, 1007 1.4/1.6 2005->

ALTERNATOR / ALTERNATOR:
VALEO: 2542485A, 603030256

CITROËN/ PEUGEOT: 5705 4H, 5705 5A, 5705 5T, 5705 6Y, 5705 6Z, 5705 GN, 9642879480

VALEO
GA1851 // NEW //
FEATURES / CARACTERÍSTICAS: 150A, Avalanche Diode, 6x60A, B+ M8X11.5mm

REPLACES / REEMPLAZA:
AS-Poland: ARC3049; **Cargo:** 239788; **Transpo:** MER531; **Era:** 216202

APPLICATION / APLICACIÓN:
NISSAN: Primastar Box 780 dCi 2006

RENAULT: Espace IV 2000 2006>2010, Trafic 2000 2006>2010

OPEL: Vivaro 2000 2006>2010

ALTERNATOR / ALTERNATOR:
VALEO: TG15C091, TG15C059, TG15C125

RENAULT: 8200725683, 8200404461, 8200525891

VALEO
GA1878

FEATURES / CARACTERÍSTICAS: 70A, 6x35A Avalanche Diode, Bolt B+: M8X15mm
REPLACES / REEMPLAZA:
 ...
APPLICATION / APLICACIÓN:
VW: Gol, Saveiro, Voyage G5, Fox, Up >2013
ALTERNATOR / ALTERNATOR:
 Valeo: TG7S019; **VW:** 04C 903 023 F

VALEO
GA1881

FEATURES / CARACTERÍSTICAS: 140A, 6x50A Avalanche Diodes
REPLACES / REEMPLAZA:
Valeo: 2607513 A3
APPLICATION / APLICACIÓN:
AUDI: A3 Limousine;
SEAT: Leon, Leon SC, Leon ST
ALTERNATOR / ALTERNATOR:
 TG14C071, 2622499A

VALEO
GA1882

FEATURES / CARACTERÍSTICAS: 120A, Diodes 6x50A, with capacitor
REPLACES / REEMPLAZA:
Valeo: 592882; **Cargo:** 136883
APPLICATION / APLICACIÓN:
VOLVO: FH12 05/98 >, NH12 05/98 >, Serie Globetroter 05/98 >.
ALTERNATOR / ALTERNATOR:
VALEO: 439231, A14N183M
VOLTAGE REGULATOR:
 GA969

VALEO
GA1892

FEATURES / CARACTERÍSTICAS: 75A, 6x35A, Avalanche diode, B+: M8X16mm, with triodiode
REPLACES / REEMPLAZA:
 -
APPLICATION / APLICACIÓN:
KIA: Picanto ex4 1.0 2012>2015
ALTERNATOR / ALTERNATOR:
Valeo: 2619399; Kia/ Hyundai: 37300-04030, 37300-04010
VOLTAGE REGULATOR:
 GA907

VALEO
GA1269 // NEW //

FEATURES / CARACTERÍSTICAS: 110A, Diode 6x50A, Avalanche, B+: M8(10mm)*M6(17mm)*27mm(Screw). External diameter 108mm
REPLACES / REEMPLAZA:
Valeo: 593175; **Mobiletron:** RP-22; **AS-Poland:** ARC3016; **Era:** 215933
APPLICATION / APLICACIÓN:
RENAULT: Clio I 1200 8V 1996>1999, Clio II 1200 8V 1998>1999, Megane 1400/1600 1996>1999, Laguna 1900 1998>1999, Espace III 2000 1997>2000;
VOLVO: S40 I 1.9 TD 1995>1999, V40 Estate 1.9 TD 1995>1999
ALTERNATOR / ALTERNATOR:
VALEO: 2541750, 2541825, 2541875, 2541882, 2541883, 2541905, 2541908, 2541937, 2541938, 2541942, 2541945, 2541976, 2541977, 2541978, 2541979, 2541983, 2541984, 2541985, 2541989, 2541999, 2542223, 2542231, 2542315, 2542316, 2542363, 2542366, 2542367, 2542368, 2542603, 2941983, A11V154, A11V176, A11V177, A11V179

VALEO
GA1276 // NEW //

FEATURES / CARACTERÍSTICAS: 90A, 6x50A Avalanche Diode, B+: M8X18.0mm. External diameter 108mm
REPLACES / REEMPLAZA:
Valeo: 593320; **Mobiletron:** RP-27; **AS-Poland:** ARC3015; **Era:** 215834
APPLICATION / APLICACIÓN:
MERCEDES-BENZ: A170 1700 1998>2001, A210 2100 Evolution 2002>2004, Vaneo 1700/1900 2002>2005
ALTERNATOR / ALTERNATOR:
VALEO: 2541922, 2541968, 2542286, 2542291, 2542347, 2542394, 2542396, 2542397, 2542398, 2542399, 2542400, 2542428, 2542429, 2542525, A13V1178, A13V1202, A13V1237, A13V1257

VALEO
GA1807

FEATURES / CARACTERÍSTICAS: 85A, Diodos 6x35A Avalanche (Zener)

REPLACES / REEMPLAZA:

Valeo: 593204; **Cargo:** 230031; **WAI/Transpo:** IPR841; **Magneti Marelli:** PR520570

APPLICATION / APLICACIÓN:

RENAULT: Clio 1.0 99>, Clio 1.0 16V 01>, Clio 1.6 without AC without DH 07/02>, Mégane 1.6 16V without AC, Scenic 1.6 without AC 02>, Kangoo 1.0 02>, Kangoo 1.6 without AC without DH 07/02>;

PEUGEOT: 206 1.0 without AC 10/02>

ALTERNATOR / ALTERNATOR:

VALEO: 439429, 439430

VOLTAGE REGULATOR:

GA984

VALEO - PARIS RHONE
GA1840

FEATURES / CARACTERÍSTICAS: 95A, Diodos 8x35A 8x35A, Avalanche (Zener)

REPLACES / REEMPLAZA:

Valeo: 2 545 941, 545 940, 592 846, 592 847, A546860A, NF007; **Cargo:** 135518; **Lucas:** UBB252; **Magneti Marelli:** 940 038 316, PR520543; **Regitar:** RP-17; **WAI/Transpo:** IPR846

APPLICATION / APLICACIÓN:

CITROËN;

FIAT;

PEUGEOT

ALTERNATOR / ALTERNATOR:

VALEO: A11VI104, A11VI105, A11VI161, A11VI185, A11VI193, A13VI104, A13VI105, A13VI106, A13VI164, A13VI117, A13VI184, A13VI185, A13VI186, A13VI209, A13VI212, A13VI213, A13VI216, A13VI218, A13VI222, A13VI264, A13VI265, A13VI266, A13VI267, A13VI268, A13VI145, A13VI152, A13VI157

VOLTAGE REGULATOR:

GA501

VALEO - PARIS RHONE
GA1841

FEATURES / CARACTERÍSTICAS: 85A, Diodos Avalanche (Zener) 6x35A, with diode trio

REPLACES / REEMPLAZA:

Valeo Paris Rhone: 2546062, 2546076, 590933, 592844, 592845, 592917, 593163; **Cargo:** 135427, **Lucas:** 592915, UBB250, UBB251, UBB253; **Magneti Marelli:** 940 038 315, 940 038 326; **Peugeot:** 5744.C2; **Regitar:** RP-14; **WAI/Transpo:** IPR844

APPLICATION / APLICACIÓN:

AUDI: A4 1.6, 1.8 20V Turbo, A6 1.8T;

CITROËN: Saxo 1.0i, 1.1i, 1.4i, Xsara 1.4, Berlingo 1.1, Evasion 1.8, 2.0, ZX 1.1, 1.4, 1.6, 1.8, 2.0;

PEUGEOT: 106, 306, 405;

FIAT: Ulysse 1.8;

SEAT: Cordoba 1.9D, TD

ALTERNATOR / ALTERNATOR:

VALEO: 2514656, 2541273, 2541348, 2541416, 2541417, 2541420, 2541473, 2541475, 2541617, 2541620, 2541644, 2541655, 2541656, 2541658, 2541665, 2541676, 2541678, 2541680, 2541683, 2541696, 2541697, 2541699, 2541703, 2541724, 2541726, 2541741, 2541767, 2541793, 2541794, 2541801, 2541802, 2541812, 2541814, 2541815, 2541816, 2541821, 4236387, 436380, 436381, 436386, 436388, 436389, A13VI134, A13VI135, A13VI137, A13VI138, A13VI155, A13VI156, A13VI170, A13VI175, A13VI176, A13VI180, A13VI198, A13VI24, A13VI67, A13VI69, A13VI70, A13VI74, A13VI75, A13VI77, A13VI78, A13VI79; **LESTER:** 13458; **PIC:** 208590

VOLTAGE REGULATOR:

GA501

VALEO - PARIS RHONE
GA1842

FEATURES / CARACTERÍSTICAS: 120A, Diodos 6x50A, with diode trio

REPLACES / REEMPLAZA:

Valeo Paris Rhone: 135 293, 2 521 487, 2 523 972, 592 845, 592 915, A546062A, NF016, NF017; **Regitar:** RP-15; **Cargo:** 231736-135494; **WAI/Transpo:** MER592

APPLICATION / APLICACIÓN:

CITROËN: Saxo 1.0i, 1.1i, 1.4i, 1.5D, Xsara 1.4, 1.5D, Berlingo 1.1, AX 1.5D, ZX 1.1, 1.4, 1.5D;

PEUGEOT: 106 0.9, 1.1, 1.3, 1.4 XT, XSI, 1.6, 1.6 Xsi, 1.6 Rallye, 306 1.1, 1.4, 1.6, 405 1.4, Partner 1.1, 1.4;

AUDI: A4 1.6, 1.8 20V, 1.9 Di, TDI, A6 1.8T, 2.3 5 cyl quattro;

VW: Passat 1.6, 1.8 20V turbo, 1.9 TDI

ALTERNATOR / ALTERNATOR:

VALEO: 2541298, 2541299, 2541410, 2541415, 2541447, 2541457, 2541458, 2541459, 2541461, 436257, 436258, 436260, 436338, 436339, 436345, 436363, 436364, 436379, A11VI10, A11VI11, A11VI21, A11VI22, 11VI23, A11VI24, A11VI25, A11VI35, A11VI36, A11VI62, A11VI66, A13N217, A13VI108, A13VI109, A13VI114, A13VI121, A13VI123, A13VI124, A13VI125, A13VI132, A13VI140, A13VI140, A13VI141, A13VI144, A13VI146, A13VI149, A13VI151, A13VI160, A13VI161, A13VI168, A13VI171, A13VI180, A13VI181, A13VI183, A13VI184, A13VI196

VOLTAGE REGULATOR:

GA501

VALEO - PARIS RHONE
GA1843

FEATURES / CARACTERÍSTICAS: 85A, Diodes Avalanche (Zener) 6x35A, with diode trio

REPLACES / REEMPLAZA:

Valeo Paris Rhone: 2546048, 546041, 592848, 592915, 592916, NF009; **Cargo:** 135278; **Lucas:** UBB254; **Magneti Marelli:** 940 038 318; **Regitar:** RP-37; **WAI/Transpo:** IPR848

APPLICATION / APLICACIÓN:

CITROËN: Saxo 1.4, ZX 1.8, 1.9d;

PEUGEOT: 405 1.6, 1.8i;

SEAT: Arosa 1.0, 1.4, Cordoba 1.0, 1.6, 1.8, 1.9, Ibiza 1.0, 1.4, 1.6, 1.8, 2.0, Inca 1.4i, 1.6i, Toledo 1.6, 1.8, 1.9;

VW: Golf 1.4i, 1.6, 1.8i, 2.0, Passat 1.6, 1.8, 1.9td, 2.0 92-97, Polo 1.0, 1.3, 1.4, Polo Classic 1.6 95-99

ALTERNATOR / ALTERNATOR:

VALEO: 2541355, 2541356, 2541360, 2541361, 2541362, 2541455, 2541731, 2541738, 2541739, 2541740, 2541758, 2541759, 2541784, 2541785, 436259, 436261, 436336, 436340, 436346, 436362, A11VI15, A11VI16, A11VI17, A11VI18, A11VI47, A11VI48, A13VI101, A13VI102, A13VI31, A13VI48, A13VI85, A13VI86, A13VI87, A13VI88, A13VI94

VOLTAGE REGULATOR:

GA501

VALEO
GA1808

FEATURES / CARACTERÍSTICAS: 85A, Diodes 6x35A Avalanche (Zener)

REPLACES / REEMPLAZA:

Valeo: 593508

APPLICATION / APLICACIÓN:

FIAT: Dobló 1.8 SOHC, OHC I 01/01>, Palio 1.8 SOHC, OHC I 02>, Stilo 1.8 02>, Strada 1.8 02>, Ducato 2.8 SOHC 03;

GM: Meriva 1.8 10/02>, Corsa sedan 1.0, 1.0 16V, 1.6, 1.6 16V 04>, Corsa 1.0 e 8 e 16V, 94>, Novo Corsa 1.0, 1.8, Sedan 02>, Celta 1.0 OHC, VHC 00>, Celta 1.4 VHC 00>, Corsa Wagon 1.0, 1.0 16V, 1.6, 1.6 16V 04>, Corsa 1.4, 1.6, 1.6 16V 94>, Corsa pick up 1.6, 1.6 16V 94>

ALTERNATOR / ALTERNATOR:

VALEO: 439512, 439513, 439514

VOLTAGE REGULATOR:

GA905 / GA984

VALEO
GA1809

FEATURES / CARACTERÍSTICAS: 120A, Diodes 6x50A Avalanche (Zener)

REPLACES / REEMPLAZA:

Valeo: 593408; **Regitar:** RP-62; **Cargo:** 235521; **WAI/Transpo:** MER528

APPLICATION / APLICACIÓN:

RENAULT: Kangoo 1.6 with AC 12/00>, Mégane 1.6 16V with AC 00>, Mégane 2.0 with AC 12/02>, Scenic 1.6 with AC 00>, Scenic 2.0 with AC 12/02>, Clio 1.6 with AC 12/00>

ALTERNATOR / ALTERNATOR:

VALEO: 439431, 430396

VOLTAGE REGULATOR:

GA911 / GA984

VALEO
GA1810

FEATURES / CARACTERÍSTICAS: 120A, Diodes 6x50A Avalanche (Zener)

REPLACES / REEMPLAZA:

Valeo: 493810

APPLICATION / APLICACIÓN:

FORD: EcoSport 1.0 Superc, 1.6 03>, Novo Fiesta, Sedan 1.0 supercharger

ALTERNATOR / ALTERNATOR:

VALEO: 439465

VOLTAGE REGULATOR:

GA984

VALEO
GA1811

FEATURES / CARACTERÍSTICAS: 120A, Diodes 6x35A Avalanche (Zener)

REPLACES / REEMPLAZA:

Valeo: 593509; **Regitar:** RP-59; **WAI/Transpo:** MER520

APPLICATION / APLICACIÓN:

PEUGEOT: 206 1.6 16V 01>, Partner 01>, 206 1.4 03>

ALTERNATOR / ALTERNATOR:

VALEO: 439515

VOLTAGE REGULATOR:

GA939

VALEO
GA1812

FEATURES / CARACTERÍSTICAS: 90A, Diodos avalanche 3x35A, M8x30 B+ Parafusos

REPLACES / REEMPLAZA:

Hyundai: 373602B100

APPLICATION / APLICACIÓN:

HYUNDAI: HB20 1.6 16V >2012, HB20 1.0 Turbo 2016>, i30 1.6 >2009

KIA: Soul 1.6 2009, Cerato 1.6 16V >2009

ALTERNATOR / ALTERNATOR:

VALEO: 26555447; **HYUNDAI:** 37300-2B101

VOLTAGE REGULATOR:

GA950

VALEO
GA1813

FEATURES / CARACTERÍSTICAS: 120A, Diodos 6x50A Avalanche (Zener), Parafuso B+ M8

REPLACES / REEMPLAZA:

-

APPLICATION / APLICACIÓN:

KIA: Soul 2.0L;

HYUNDAI: I-30 2009>, Elantra 2.0 2007-2012

ALTERNATOR / ALTERNATOR:

VALEO: 2655635, 37300-23650

VOLTAGE REGULATOR:

GA913

VALEO
GA1815

FEATURES / CARACTERÍSTICAS: 120A, Diodos 6x35A Avalanche (Zener)

REPLACES / REEMPLAZA:

Valeo: 493815

APPLICATION / APLICACIÓN:

FORD: EcoSport 2.0 04>, Escort, SW 1.6 Zetec Rocam 00>, Fiesta, Sedan 1.0, 1.6 with AC 99>, Novo Fiesta, Sedan 1.0, 1.6 with AC 01>, Ka 1.0, 1.6 Zetec Rocam with AC 10/02>, Courier Zetec Rocam 1.6, 1.0 07/99>

ALTERNATOR / ALTERNATOR:

VALEO: 439466

VOLTAGE REGULATOR:

GA984

VALEO
GA1819

FEATURES / CARACTERÍSTICAS: 100A, Diodos 8x35A Avalanche (Zener), with diode trio

REPLACES / REEMPLAZA:

Valeo: 493819; **Cargo:** 235886; **WAI/Transpo:** MER540

APPLICATION / APLICACIÓN:

GM: Corsa 1.0 e 1.6 all with AC 94>, Blazer/ S10 Gas 2.0 97>, Astra 1.8, 2.0 16V, 2.0 99>, Omega/ suprema 3.0/4.1 09/92>, Vectra 2.0/2.8/ 16 V 93>, Meriva 1.4 2008

ALTERNATOR / ALTERNATOR:

VALEO: 439427, 93312974, SG9B082

VOLTAGE REGULATOR:

GA911

VALEO
GA1820

FEATURES / CARACTERÍSTICAS: 120A, Diodos 6x35A Avalanche (Zener)

REPLACES / REEMPLAZA:

...

APPLICATION / APLICACIÓN:

PEUGEOT: 207, 307

ALTERNATOR / ALTERNATOR:

2610426, SG9B127

VOLTAGE REGULATOR:

GA905 / GA930

VALEO
GA1823

FEATURES / CARACTERÍSTICAS: 100A, Diodos 8x35A Avalanche (Zener), with diode trio

REPLACES / REEMPLAZA:

Valeo: 493823; **Magneti Marelli:** PR520566

APPLICATION / APLICACIÓN:

NISSAN: Nissan Frontier 2.8 TD MWM 10/02>, Nissan X Terra 2.8 TD MWM 10/02>;

GM: Blazer/ S10 Diesel 2.8 00>;

TROLLER: Troller T4/T4M/ vehiculos especiales 10/02>, Meriva 1.4 2008

ALTERNATOR / ALTERNATOR:

VALEO: 439428, 93312974, SG9B082

VOLTAGE REGULATOR:

GA911 / GA920

VALEO

GA1825

FEATURES / CARACTERÍSTICAS: 100A, Diodos 8x35A Avalanche (Zener)

REPLACES / REEMPLAZA:

Valeo: 493825

APPLICATION / APLICACIÓN:

FIAT: Doblo 1.8 OHC I 03>, Palio 1.8 OHC I 02>, Stilo 1.8 03>;

GM: New Corsa, Sedan 1.0 02>

ALTERNATOR / ALTERNATOR:

VALEO: 439517, 439519

VOLTAGE REGULATOR:

GA905

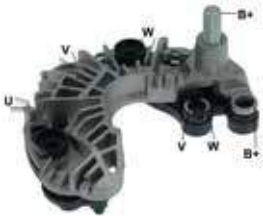
VALEO

GA1826

FEATURES / CARACTERÍSTICAS: 105A, 3x35A avalanche diodes, M8x30 B+ bolt

REPLACES / REEMPLAZA:

-

APPLICATION / APLICACIÓN:

Hyundai: Tucson, Sportage, Cerato

ALTERNATOR / ALTERNATOR:

Valeo: 2655023, 2455023, 2655474, TG9S018

VOLTAGE REGULATOR:

GA921

VALEO

GA1830

FEATURES / CARACTERÍSTICAS: 120A, Diodos 6x50A Avalanche (Zener)

REPLACES / REEMPLAZA:

Valeo: 493830; **WAI/Transpo:** MER538

APPLICATION / APLICACIÓN:

GM: New Corsa, Sedan 1.8 02>, Meriva 1.8 02>

ALTERNATOR / ALTERNATOR:

VALEO: 439 520, 439522, SG9B083

VOLTAGE REGULATOR:

GA905

VALEO

GA1831

FEATURES / CARACTERÍSTICAS: 120A, Diodos Avalanche 3x50A, M8x30 B+ Parafusos

REPLACES / REEMPLAZA:

Valeo: 2626949

APPLICATION / APLICACIÓN:

FORD: Focus 2.0, New Fiesta, Eco Sport Titanium; **PEUGEOT:** 208 1.2 2017

ALTERNATOR / ALTERNATOR:

VALEO: 2605459-A, TG12C106, TG12C108; **FORD:** AE8T-10300-BA, CN1510300CC; **PEUGEOT:** 9670899580

VOLTAGE REGULATOR:

GA906

VALEO

GA1832

FEATURES / CARACTERÍSTICAS: 120A, Diodos 6x50A Avalanche (Zener)

REPLACES / REEMPLAZA:

Valeo: 493832; **Cargo:** 235555; **WAI/Transpo:** MER529

APPLICATION / APLICACIÓN:

PEUGEOT: 206 1.6 16V 01>;

CITROËN: Xzara Picasso 2.0L with AC

ALTERNATOR / ALTERNATOR:

VALEO: 439445, 439521

VOLTAGE REGULATOR:

GA939 / GA980

VALEO

GA1853

FEATURES / CARACTERÍSTICAS: 90A, 6x50A, B+: M8x13mm

REPLACES / REEMPLAZA:

Cargo: 236997; **AS-Poland:** ARC3056; **Transpo:** MER533

APPLICATION / APLICACIÓN:

FIAT: 500 1.3 2007>2015, Grande Punto 1.3 2005>2015, Idea 1.3 2004>2015, Linea 1.3 2007>2015, Punto Evo 1.3 2009>2012, Strada 1.3 2006>2015

LANCIA: Musa 1.3 2004>2015, Ypsilon 1.3 2003>2015

OPEL: Agila A 1.3 2003>2008, Astra H 1.3 2005>2010, Combo C 1.3 2003>2015, Meriva A 1.3 2003>2010, Tigra B 1.3 2005>2015

ALTERNATOR / ALTERNATOR:

FIAT: 55185076

CHEVROLET: 13117279, 13283344BW, 704042419

OPEL: 13283344BW

VALEO
GA1854

FEATURES / CARACTERÍSTICAS: 90A, 6x35A, Avalanche Diode B+: M8x15.2mm

REPLACES / REEMPLAZA:

Valeo: 235653, 593530

APPLICATION / APLICACIÓN:

CITROËN: Berlingo 1.4 2002>2005, C1 1.4 2005>2014, C5 1.8/2.0 16V 2001>2004, C8 2.0/2.2 2002, Nemo box/estate 1.4 2009, Xsara break/coupe 1.6 16V 2000>2004, Xsara picasso 1.8 16V 2000>2006

FIAT: Scudo box 1.9 2004>2006, Ulysse 2.0 2002>2011

ALTERNATOR / ALTERNATOR:

VALEO: SG10B022

CITROËN: 9642880180, 9655858280, 9665580680, 5705 5V, 5705 7E, 5705 7F

FIAT: 9642880480, 9649611280

VALEO
GA1883

FEATURES / CARACTERÍSTICAS: 85A, Diodes 6x35A Avalanche (Zener)

REPLACES / REEMPLAZA:

Valeo: 593483; **WAI/Transpo:** MER536

APPLICATION / APLICACIÓN:

VW: Gol 1.0 e 1.6 with AC without DH 03>, Polo 1.0/ 1.6 with AC without DH 03>, Fox 1.0/ 1.6 with AC without DH 03>, Golf 1.6 with AC without DH 99>

ALTERNATOR / ALTERNATOR:

VALEO: 439439

VALEO
GA1884

FEATURES / CARACTERÍSTICAS: 120A, Diodes 6x50A Avalanche (Zener)

REPLACES / REEMPLAZA:

Valeo: 593482

APPLICATION / APLICACIÓN:

VW: Polo, Polo Sedan 1.0L 16V, 1.6L with AR, Fox 1.0L 16V with AR with DH

ALTERNATOR / ALTERNATOR:

VALEO: 439445

VOLTAGE REGULATOR:

GA980

VALEO
GA1885

FEATURES / CARACTERÍSTICAS: 120A, Diodes Avalanche 3x50A, M8x30 B+ Parafusos

REPLACES / REEMPLAZA:

-

APPLICATION / APLICACIÓN:

RENAULT: Megane, Scenic 2.0 16V >2007, Grand Scenic 1.6 >2004, Kangoo 1.6 >2008

ALTERNATOR / ALTERNATOR:

VALEO: TG11C060, 2543551F, TG11C065, TG11C069, TG11C039, TG9B053, TG11S142; **VW:** 04C 903 024A

VOLTAGE REGULATOR:

GA985

VALEO
GA1886

FEATURES / CARACTERÍSTICAS: 105A, 3x35A Avalanche Diodes, B+ M6x15

REPLACES / REEMPLAZA:

...

APPLICATION / APLICACIÓN:

Toyota: Etios

ALTERNATOR / ALTERNATOR:

Valeo: FG7T010;

Toyota: 27060-0Y110

VALEO

GA1887

FEATURES / CARACTERÍSTICAS: 70A, 3x35A Avalanche Diodes

REPLACES / REEMPLAZA:

...

APPLICATION / APLICACIÓN:

KIA: Picanto 1.0 2008>

ALTERNATOR / ALTERNATOR:
2655517

VOLTAGE REGULATOR:

GA293

VALEO

GA1998

FEATURES / CARACTERÍSTICAS: 90A,6X 35A Avalanche Diodes

REPLACES / REEMPLAZA:

GM: 94 700 046, 94 700 045

APPLICATION / APLICACIÓN:

Chevrolet: Corsa, Agile, Montana, Meriva without A/C 1.4/1.8

ALTERNATOR / ALTERNATOR:

Valeo: 2605231, SG9B114, 2605232, SG9B115

VOLTAGE REGULATOR:

GA998

VISTEON

GA1890

FEATURES / CARACTERÍSTICAS: 95A, Diodes 8x35A Avalanche (Zener), B+ Post M6

REPLACES / REEMPLAZA:

Regitar: RF-19H; **WAI/Transpo:** FR6100

APPLICATION / APLICACIÓN:

FORD: Fiesta, Ka, EcoSport

ALTERNATOR / ALTERNATOR:

20 150 01005, 1S7T-10300-BA, 1S7Z-10346-BC

VOLTAGE REGULATOR:

GA350 / GA360

VISTEON

GA1891

FEATURES / CARACTERÍSTICAS: 140A, Avalanche Diodes 8x50A, B+ Bolt M6, Ø 114mm

REPLACES / REEMPLAZA:

Regitar: RF-18HV

APPLICATION / APLICACIÓN:

FORD: Focus I, Mondeo, EcoSport

ALTERNATOR / ALTERNATOR:

Ford: 1S7T10300BA, 1S7T10300BB, 1S7T10300BC, 1S7T10300BD, 1S7Z10346BC, 1S7TBA, 1S7TBB, 1S7TBC, 1S7TBD, 2S6T10300AA, 2S6T10300AC, 2S6T10300FA, 2S6T10300FB, 2S6T10300FC, 2T1U10300BB, 2T1U10300BC, 2T1U10300BD, 3S5T10300AA, 3S6T10300AA, 3S6T10300AB, 5S6Y10300AA, 5S6Y10300AB, 5S6Y10300AC, 5S6Y10300AD; Visteon: 2015001001, 2015001002, 2015001003, 2015001005, 1120211, 1140696, 1151212, 1464779

VOLTAGE REGULATOR:

GA350



ELECTRICAL SPARE PART | PIEZA ELÉCTRICA

REGULATOR / RECTIFIER | REGULADOR / RECTIFICADOR

HITACHI
GA3000

FEATURES / CARACTERÍSTICAS: 14V, 'A' Circuit, 80A, 8X35A, B+: M6x10mm

REPLACES / REEMPLAZA:

...

APPLICATION / APLICACIÓN:

INFINITI: QX4 3.3 1997>;

NISSAN: Pathfinder MK2 3.3 V6 1998>2000

ALTERNATOR / ALTERNADOR

Hitachi: LR190737, LR190737B, LR190737E;

Nissan / Infiniti: 23100-0W001, 23100-0W001R, 23100-0W002, 23100-0W003, 23100-0W004

HITACHI
GA3001

FEATURES / CARACTERÍSTICAS: 14V, 'A' Circuit, 90A, Diodes: 6, B+: M5x44mm

REPLACES / REEMPLAZA:

...

APPLICATION / APLICACIÓN:

ISUZU: Midi Bus/Midi Van 2.0 TD/2.2 D/2.2 D 4WD 1988>1992, Midi Box 2.2 D/2.2 D 4WD 1988>1992

ALTERNATOR / ALTERNADOR

Isuzu: 8944119072

HITACHI
GA3002

FEATURES / CARACTERÍSTICAS: 14V, 'A' Circuit, 55A, Diodes: 6, B+: M5x31mm

REPLACES / REEMPLAZA:

...

APPLICATION / APLICACIÓN:

CHEVROLET TRUCK: LUV L4 2.2 Diesel 1981>1982;

ISUZU TRUCK: Pickup L4 2.2 Diesel 1981

ALTERNATOR / ALTERNADOR

Hitachi: LR140-112, LR140-131, LR140-131B, LR140-138;

Isuzu: 8942214514, 8942469570, 8942469571

HITACHI
GA3003

FEATURES / CARACTERÍSTICAS: 14V, 'A' Circuit, 80A, 8X35A, B+: M8x30mm

REPLACES / REEMPLAZA:

Mobiletron: RV-H078; **AS Poland:** ARR2020

APPLICATION / APLICACIÓN:

ISUZU: Rodeo Pickup 2.5/3.0 DiTD 4x4 2002>2015, D-Max 2.5 TD 2002>2015, D-Max 3.0 TD 2002>2015, Pickup 2.5 TD 2002>2015

ALTERNATOR / ALTERNADOR

Hitachi: LR180513, LR180513B;

Isuzu: 897327218, 8973272181

HITACHI
GA3004 // NEW //

FEATURES / CARACTERÍSTICAS: 14V, 'A' Circuit, 70A, 6X35A, B+ M8X38.5mm

REPLACES / REEMPLAZA:

TRANSPO: IHR749+IH776

MOBILETRON: VR-H2000-53 + RH-48

APPLICATION / APLICACIÓN:

OPEL: Astra Mk3 1.7 1996>1998, Corsa B 1.5/1.7 1996>2000, Corsa B Box 1999>2000, Vectra B 1.7 1995>1996, Astra Van 1.7 1996>1998, Corsa/Combo 1.7 1996>2001;

VAUXHALL: Vectra B/Vectra B 1.7 Hatchback 1995>1996

ALTERNATOR / ALTERNADOR

HITACHI: LR170-505, LR170-505B; **ISUZU:** 8-9715-0200-0, 8971502001; **MAGNETI MARELLI:** 943356591010; **OPEL:** 6204042, 6204046; **VALEO:** 439509

HITACHI
GA3005 // NEW //

FEATURES / CARACTERÍSTICAS: 28V, 'A' Circuit, 50A, 8X35A, B+: M6X37mm / M5X17.5mm, SET POINT: 28,5mm

REPLACES / REEMPLAZA:

MOBILETRON: VR-H2000-86B + RH-74

APPLICATION / APLICACIÓN:

...

ALTERNATOR / ALTERNADOR

HITACHI: LR250-502C, LR250-507, LR250-507C; **ISUZU:** 8-97075-883-2, 8-97148-496-0, 8-97148-496-1

HITACHI
GA3006 // NEW //

FEATURES / CARACTERÍSTICAS: 14V, 'A' Circuit, 100A, Diode 8X50A, B+: M8X39.5mm

REPLACES / REEMPLAZA:

MOBILETRON: RV-H002; **TRANSPO:** 48-8108; **ERA:** 215943; **CARGO:** 333602; **AS-POLAND:** ARR2001

APPLICATION / APLICACIÓN:

HONDA: Civic 1700 2002>2005

OPEL: Astra G 1700 16V 2000>2005, ASTRA G Box (F70) Eng.Y 17 DT 1.7 DTI 16V 2000>2005, Corsa C 1700 16V 2000>2003, Corsa D 1700 16V 2006>2010, Meriva A 1700 16V 2003>2005

VAUXHALL: Astra 1.7 CDTI 2003>2005, Corsa C Z17D7DTL 1.7 DTI 2000>2015, Astravan G Y17DT 1.7 DTI 2000>2015

ALTERNATOR / ALTERNADOR

HITACHI: LR1100502, LR1100502B, LR1100-502E, LR1100502F, LR1100502G, LR1100502J, LR1100502K, LR1100502L, LR1100504C, LR1100504E;

ISUZU: 897181891130, 8971891133, 8971891134, 8971891135, 8971891136, 8971891137, 8971891138, 8972873923, 971891113;

VAUXHALL: 1204158, 6240140, 9312785, 93175799, 93175944, 971891113

HITACHI
GA3007 // NEW //

FEATURES / CARACTERÍSTICAS: 14V, 'A' Circuit, 100A, Diode 6X50A, B+: M8X39.5mm

REPLACES / REEMPLAZA:

MOBILETRON: RV-H008; **TRANSPO:** 48-8103; **ERA:** 215944; **AS-POLAND:** ARR2044

APPLICATION / APLICACIÓN:

HONDA: Civic 1700 2002>2005;

OPEL: Astra G 1700 16V 2000>2005, ASTRA G Box (F70) Eng.Y 17 DT 1.7 DTI 16V 2000>2005, Corsa C 1700 16V 2000>2003, Corsa D 1700 16V 2006>2010, Meriva A 1700 16V 2003>2005;

VAUXHALL: Astra 1.7 CDTI 2003>2005, Corsa C Z17D7DTL 1.7 DTI 2000>2015, Astravan G Y17DT 1.7 DTI 2000>2015;

ALTERNATOR / ALTERNADOR

HITACHI: LR1100-502MD

HITACHI
GA3008 // NEW //

FEATURES / CARACTERÍSTICAS: 14V, 'A' Circuit, 70A, 6X50A, B+ M8X38.5mm

REPLACES / REEMPLAZA:

MOBILETRON: RVH001 (VR-H2000-53 + RH-72); **TRANSPO:** 48-8116; **CARGO:** 138190

APPLICATION / APLICACIÓN:

OPEL: Astra Mk3 1.7 1996>1998, Corsa B 1.5/1.7 1996>2000, Corsa B Box 1999>2000, Vectra B 1.7 1995>1996, Astra Van 1.7 1996>1998, Corsa/Combo 1.7 1996>2001

VAUXHALL: Vectra B/Vectra B 1.7 Hatchback 1995>1996

ALTERNATOR / ALTERNADOR

HITACHI: LR170-505, LR170-505B; **ISUZU:** 8-9715-0200-0, 8971502001; **MAGNETI MARELLI:** 943356591010; **OPEL:** 6204042, 6204046; **VALEO:** 439509



ELECTRICAL SPARE PART | PIEZA ELÉCTRICA

DIODE | DIODO

DIODE GA1008-POS / GA1008-NEG

FEATURES / CARACTERÍSTICAS:
 70A - Diameter: 12,8 mm. Avalanche Type
 Package: 10 units
APPLICATION / APLICACIÓN:
 ...

DIODE GA1009-POS / GA1009-NEG

FEATURES / CARACTERÍSTICAS:
 70A - Diameter: 12,8 mm. Avalanche Type
 Package: 10 units
APPLICATION / APLICACIÓN:
 ...

DIODE GA1100-POS / GA1101-NEG

FEATURES / CARACTERÍSTICAS:
 35A - Diameter: 12,8 mm. Press-fit type Wapsa Heavy Duty
 Package: 10 units
APPLICATION / APLICACIÓN:
 Alternators WAPSA / BOSCH.

DIODE GA1103-POS

FEATURES / CARACTERÍSTICAS:
 35A - Diameter: 12,8 mm Press-fit type Wapsa Heavy Duty
 Package: 10 units
APPLICATION / APLICACIÓN:
 Alternators WAPSA / BOSCH.

DIODE GA1104-POS / GA1105-NEG

FEATURES / CARACTERÍSTICAS:
 35A Diameter: 12,8 mm. Press-fit type Wapsa Heavy Duty
 type flag female terminal
 Package: 10 units
APPLICATION / APLICACIÓN:
 Alternators WAPSA / BOSCH.

DIODE GA1106-POS / GA1107-NEG

FEATURES / CARACTERÍSTICAS:
 35A Diameter: 12,8 mm. Press-fit type Wapsa Heavy Duty
 Package: 10 units
APPLICATION / APLICACIÓN:
 Alternators BOSCH.

DIODE GA1108-POS

FEATURES / CARACTERÍSTICAS:
 35A Diameter: 12,8 mm. Press-fit type Bosch Heavy Duty
 Package: 10 units
APPLICATION / APLICACIÓN:
 Alternators BOSCH.

DIODE GA1109-POS / GA1110-NEG

FEATURES / CARACTERÍSTICAS:
 35A DIODE type Tin Can Diameter: 8,75mm.
 Package: 10 units
APPLICATION / APLICACIÓN:
 Many imported vehicles.

DIODE GA1112-POS / GA1113-NEG

FEATURES / CARACTERÍSTICAS:
 50A Diameter: 12,8 mm. Press-fit type Bosch Extra Heavy Duty
 Package: 10 units
APPLICATION / APLICACIÓN:
 Alternators BOSCH.

DIODE GA1114P-POS / GA1114N-NEG

FEATURES / CARACTERÍSTICAS:
 35A DIODE type Mitsubishi
 Package: 10 units
APPLICATION / APLICACIÓN:
 Alternators MANDO, MITSUBISHI, MIDO.

DIODE GA1115P-POS / GA1115N-NEG

FEATURES / CARACTERÍSTICAS:
 50A Diameter: 11,5mm. Extra Heavy Duty
 Package: 10 units
REPLACES / REEMPLAZA
 Cargo: 136253, 136254
APPLICATION / APLICACIÓN:
 Alternators HITACHI.

DIODE GA1102

FEATURES / CARACTERÍSTICAS:
 3A Excitation Diode
 Package: 10 units
APPLICATION / APLICACIÓN:

DIODE GA1121P-POS / GA1121N-NEG

FEATURES / CARACTERÍSTICAS:
 24V-32V 35A Avalanche (Zener). Diameter: 12,8 mm. Pressfit
 Bosch
 Package: 10 units
APPLICATION / APLICACIÓN:

DIODE GA1122P-POS / GA1122N-NEG

FEATURES / CARACTERÍSTICAS:
 38V-42V 35A Avalanche (Zener). Diameter: 12,8 mm. Pressfit
 Bosch
 Package: 10 units
APPLICATION / APLICACIÓN:

DIODE GA1123P-POS / GA1123N-NEG

FEATURES / CARACTERÍSTICAS:
 24V-32V 50A Avalanche (Zener). Diameter: 12,8 mm. Pressfit
 Bosch
 Package: 10 units
APPLICATION / APLICACIÓN:

DIODE GA1124P-POS / GA1124N-NEG

FEATURES / CARACTERÍSTICAS:
 39V-47V 50A Avalanche (Zener). Diameter: 12,8 mm. Pressfit
 Bosch
 Package: 10 units
APPLICATION / APLICACIÓN:

DIODE GA1125P-POS / GA1125N-NEG

FEATURES / CARACTERÍSTICAS:
 24V-32V 50A Avalanche (Zener). Diameter: 10 mm. Pressfit
 Lucas
 Package: 10 units
APPLICATION / APLICACIÓN:

DIODE GA1352-35A / GA1502-50A

FEATURES / CARACTERÍSTICAS:
DIODES type Button
 Package: 10 units
APPLICATION / APLICACIÓN:

DIODE TRIO GA1002

FEATURES / CARACTERÍSTICAS:
DIODES excit. 3A
 Package: 1 unit
APPLICATION / APLICACIÓN:
 Replaces: Bosch: 1 121 099 005 Alternators Diversos

DIODE TRIO GA1005

FEATURES / CARACTERÍSTICAS:
DIODES excit. 3A Compatible w/ GA1006
 Package: 1 unit
APPLICATION / APLICACIÓN:
 Replaces: Bosch: 9 121 450 594, Wapsa: 436-01 Alternators:
 Wapsa.

DIODE TRIO GA1116

FEATURES / CARACTERÍSTICAS:
 Package: 10 units
APPLICATION / APLICACIÓN:
 Alternators type Magneti Marelli

DIODE TRIO GA1117

FEATURES / CARACTERÍSTICAS:
 Package: 10 units
APPLICATION / APLICACIÓN:
 Alternators type Magneti Marelli
 P.S: without connector. GA1116 with connector

DIODE TRIO GA1220

FEATURES / CARACTERÍSTICAS:
 Package: 10 units.
APPLICATION / APLICACIÓN:
 Replaces: **Delco**: 1.984.032, 3.472.312, 7.982.635, GM:
 52.278.220. Alternators: 11S de 28A à 55A, Chevete, Opala,
 Utilitários.

DIODE TRIO GA1221

FEATURES / CARACTERÍSTICAS:
 Package: 10 units
APPLICATION / APLICACIÓN:
 Replaces: **Delco**: 1.971.528, 1.984.459, **GM**: 52.278.221 Alterna-
 tors: **Delco** 10S, 12S, 15S e 17S (42A a 65A).

DIODE TRIO GA1222

FEATURES / CARACTERÍSTICAS:
 Package: 10 units
APPLICATION / APLICACIÓN:
 Replaces: **Delco** 1876797, 10456389 For: **Delco** 30SI Series IR/
 EF Alternators

DIODE TRIO GA1223

FEATURES / CARACTERÍSTICAS:
 Package: 10 unit
APPLICATION / APLICACIÓN:
 Replaces: **Delco** 1977064, D3918, D3921 For: **Delco** 27SI type
 100, 200 Series IR/EF

DIODE GA1224

FEATURES / CARACTERÍSTICAS:
 Package: 10 unit
APPLICATION / APLICACIÓN:
 Replaces: **Delco**: 10517358 For: Alternators **Delco** Series 21SI
 Alternator: **Delco**: 1117965; 19010112; 19010196; 19010105

DIODE GA1225

FEATURES / CARACTERÍSTICAS:
 3x3A
APPLICATION / APLICACIÓN
AGRALE: Volare V8;
FOTON: Trucks with Cummins engine

DIODE



FEATURES / CARACTERÍSTICAS:

3x10A. With Autostart

REPLACES / REEMPLAZA

Delco: 10517356, 10487805; **Transpo:** DT22

APPLICATION / APLICACIÓN

Freightliner Heavy Duty: FL 50 Caterpillar 3126, FL 50

Cummins 1998>2004; **International Medium/Heavy**

Truck: 8100-8600 Heavy

ALTERNATOR / ALTERNADOR

Delco: 19020302, 19020310

GA1226

DIODE TRIO



FEATURES / CARACTERÍSTICAS:

DIODES excit. 2A Compatible w/ GA1274

Package: 1 unit

APPLICATION / APLICACIÓN:

Replaces: **Lucas** 352.13.293 Alternators: **Lucas**

GA1293



ELECTRICAL SPARE PART | PIEZA ELÉCTRICA

MISCELLANEOUS | DIVERSOS

GD0007 // NEW //



FEATURES / CARACTERÍSTICAS:
14V

REPLACES / REEMPLAZA:

Denso: 021620-3020; **Cargo:** 235607; **Mobiletron:** BH-ND06;
AS-Poland: ABH6004

APPLICATION / APLICACIÓN:

TOYOTA: Hi-Ace IV 2.5 D-4D 2001>2006, Land Cruiser 3.0 D-4D 2000>2007, Hi-Lux - LCV 2.5 D-4D 2001>2006

ALTERNATOR / ALTERNADOR:

Denso: 270600I020, 104210309, 1042109000, 1042103090, 1042103091, 1042103092, 1042109010, 1042109011, 270600L021, 1042109341, 270600I022, 1042104790, 270600C020, 1042102061, 2706031072, BC1042107002

GD0008 // NEW //



FEATURES / CARACTERÍSTICAS:
14V

REPLACES / REEMPLAZA:

Transpo: 39-8200-1; **Cargo:** 132084; **AS-Poland:** ABH6001

APPLICATION / APLICACIÓN:

ACURA: Integra L4 1.6L 1986>1987;

HONDA: CRX 1600 16V 1987>1991, Integra 1600 16V 1986>1990;

BOBCAT: 320 Kubota D750 Dsl 1993>1999, 322 Kubota D722EB Dsl 2000>2006, 322D Kubota D722B Dsl 2000, 325 Kubota D1703B Dsl 1997>2011, 10 Kubota D722-E2B Dsl 2008>2013

ALTERNATOR / ALTERNADOR:

Acura: 31100-PG7-013, 31100-PG7-013RM, 31100-PH7-004, 31100-PH7-024, 31100-PH7-024RM, 31100-PP8-004, 31100-PP8-014, 31100-PP8-014RM, 8-97109-780-1, 8-97167-157-0, 8-97187-304-0, CHA16, CJK46

Bobcat: 6669618

GD0010 // NEW //



FEATURES / CARACTERÍSTICAS:
24V

REPLACES / REEMPLAZA:

...

APPLICATION / APLICACIÓN:

TOYOTA: Corolla 2002

ALTERNATOR / ALTERNADOR:

CHERY: JFZ21A23, JFZ21A26 **DENSO:** 1012115080, 2706015110, 1022119090, 1012115500, 1012101000, 270600D280, 1012119980

GD0011 // NEW //



FEATURES / CARACTERÍSTICAS:

...

REPLACES / REEMPLAZA:

...

APPLICATION / APLICACIÓN:

Hyundai: Azera 3.3 2007>2011, Vera Cruz 3.8 V6 4WD 2007->, Santa FE 2.7 V6 GLS 4x4 2006>2009, Sonata 3.3 2004>2012

KIA: Sorento 3.3 V6 4WD 2007->, Mohave 3.8 EX 4WD 2009->

ALTERNATOR / ALTERNADOR:

DENSO: 02131-9153 HYUNDAI / KIA: 37300-3C120



ELECTRICAL SPARE PART | PIEZA ELÉCTRICA

BEARING | RODAMIENTO

GR382

2RS/C3 (DDU)

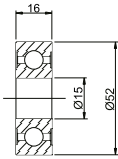

FEATURES / CARACTERÍSTICAS: Ball Bearing
APPLICATION / APLICACIÓN: Toyota
REPLACES / REEMPLAZA: KOYO 382

GR2790

2RS/C3 (DDU)

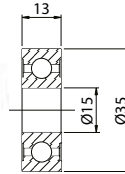

FEATURES / CARACTERÍSTICAS: Ball Bearing
APPLICATION / APLICACIÓN: Alternator
 Honda: 31111-PD1-004; John Deere: AR88019;
 Nippondenso: 949100-3980; Toyota: 90099-10140

GR3190

 2RS/C3 (DDU) // **NEW** //

FEATURES / CARACTERÍSTICAS: Ball Bearing
APPLICATION / APLICACIÓN: Alternadores:
 Honda: 31114-PD1-004 / Nippondenso: 949100-2800, 949100-3290 / Toyota: 9099-10159
REPLACES / REEMPLAZA:
 DENSO: 949100-3190, 949100-3290
 CARGO: 140443

GR3330

2RS/C3 (DDU)



FEATURES / CARACTERÍSTICAS: Ball Bearing
APPLICATION / APLICACIÓN: Alternator
 Nippondenso: 949100-4370; Toyota: 90099-10160, 90099-10192

GR3360

2RS/C3 (DDU)

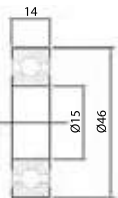

FEATURES / CARACTERÍSTICAS: Ball Bearing
APPLICATION / APLICACIÓN: Alternator
 Honda: 31114-PD1-034; Nippondenso: 949100-3380, 949100-4620; Toyota: 90099-04966, 90099-10159, 90099-10161, 90099-10199

GR3480

2RS/C3 (DDU)

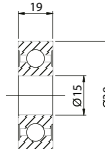

FEATURES / CARACTERÍSTICAS: Ball Bearing
APPLICATION / APLICACIÓN:
 NIPPONDENSO: Alternator on Chevrolet, Daihatsu, Geo, Isuzu, Kubota, Suzuki, Toyota
REPLACES / REEMPLAZA:
PFI: 949100-3480; **CARGO:** 140461;
Koyo: DDG15382RDH1CM;
Nippondenso: 949100-3480, 949100-3481;
Toyota: 90099-10170

GR3660

2RS/C3 (DDU)

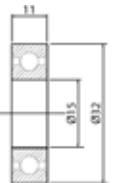

FEATURES / CARACTERÍSTICAS: Ball Bearing
APPLICATION / APLICACIÓN: Alternator
 Nippondenso: 94910-3670

GR3820

 2RS/C3 (DDU) // **NEW** //

FEATURES / CARACTERÍSTICAS: Ball Bearing
APPLICATION / APLICACIÓN:
 Toyota alternator: 90099-10178

GR607

2RS/C3 (DDU)

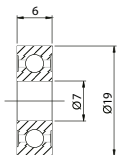

FEATURES / CARACTERÍSTICAS: Ball Bearing
APPLICATION / APLICACIÓN:
 Black & Decker; Bosch; Dewalt; Makita: Power tools;
REPLACES / REEMPLAZA:
PFI: 607- 2RS C3;
NSK: 607DDMC3E;
Bosch: 2600905032

GR608

2RS/C3 (DDU)

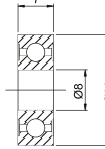

FEATURES / CARACTERÍSTICAS: Ball Bearing
APPLICATION / APLICACIÓN: Industrial - Automotive Windows FORD; GM; VW

GR609

2RS/C3 (DDU)

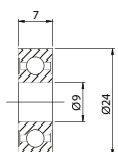

FEATURES / CARACTERÍSTICAS: Ball Bearing
APPLICATION / APLICACIÓN:
 Black & Decker; Bosch; Dewalt; Makita: Power tools;
REPLACES / REEMPLAZA:
PFI: 609 - 2RS C3; **NSK:** 609DDMC3E

GR627

2RS/C3 (DDU)

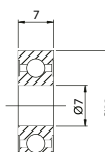

FEATURES / CARACTERÍSTICAS: Ball Bearing
APPLICATION / APLICACIÓN:
 Black & Decker; Bosch; Dewalt; Makita; Skill: Power tools;
REPLACES / REEMPLAZA:
NTN: 627LU; **PFI:** 627-2RS C3

GR628

2RS/C3 (DDU)

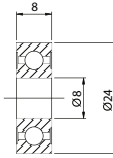
FEATURES / CARACTERÍSTICAS: Ball Bearing

APPLICATION / APLICACIÓN:

Black & Decker; Bosch; Dewalt; Makita; Skill: Power tools;

mitsuba: SM402, SM512 PMGR and PMOSGR starters - Acura, Honda (CE);

REPLACES / REEMPLAZA:
Koyo: 628Z; **PFI:** 628-2RS C3

GR629

2RS/C3 (DDU)

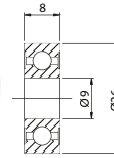
FEATURES / CARACTERÍSTICAS: Ball Bearing

APPLICATION / APLICACIÓN:

Mitsubishi: OSGR + PLGR starters; Acura; Case; Dodge; Ford; Infiniti; Mazda; Mitsubishi; Nissan; Toro (armature); Prestolite: GJG Series Marine Generators (CE)

REPLACES / REEMPLAZA:
PFI: 629 - 2RS C3; **NSK:** 629-A-4DDMC3; **Bosch:** 2600905062; **Motorcraft:** MCE-432; **Prestolite:** 25-23, GJH-45

GR6000

2RS/C3 (DDU)

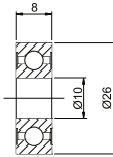
FEATURES / CARACTERÍSTICAS: Ball Bearing

APPLICATION / APLICACIÓN: For alternator Delco Remy. For various industrial applications

GR6001

2RS/C3 (DDU)

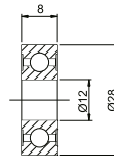
FEATURES / CARACTERÍSTICAS: Ball Bearing

APPLICATION / APLICACIÓN: For alternator Kia: Asia, Besta and Topic, embreagem CG125 (Honda). For various industrial applications.

GR6002

2RS/C3 (DDU)

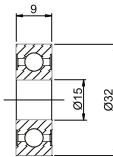
FEATURES / CARACTERÍSTICAS: Ball Bearing

APPLICATION / APLICACIÓN: For starter Delco Remy. For various industrial applications.

GR6003

2RS/C3 (DDU)

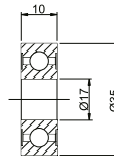
FEATURES / CARACTERÍSTICAS: Ball Bearing

APPLICATION / APLICACIÓN: For alternator Bosch, Magneti Marelli; Fiat Palio, Yamaha XT600. For various industrial applications.

GR6003DW

2RS/C3 (DDU)

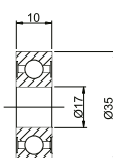
FEATURES / CARACTERÍSTICAS: Ball Bearing

APPLICATION / APLICACIÓN: Alternator M Marelli Fiat Palio.

GR6004

2RS/C3 (DDU)

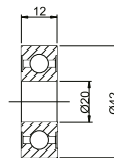
FEATURES / CARACTERÍSTICAS: Ball Bearing

APPLICATION / APLICACIÓN: For starter Mitsubishi, hydraulic pump VW-11130, 13130, 14140. For various industrial applications.

GR6005

2RS/C3 (DDU)

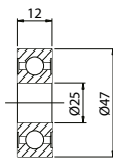
FEATURES / CARACTERÍSTICAS: Ball Bearing

APPLICATION / APLICACIÓN: Starter Motors 28MT (Volvo, Fiat Allis), Agricultural Equipments

GR6006

2RS/C3 (DDU)

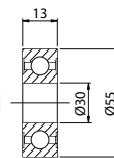
FEATURES / CARACTERÍSTICAS: Ball Bearing

APPLICATION / APLICACIÓN: Agricultural equipment, Automotive applications, Engine Maxion 3640, Frontal cover BR800

GR6007

2RS/C3 (DDU)

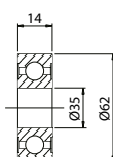

FEATURES / CARACTERÍSTICAS: Ball Bearing

APPLICATION / APLICACIÓN: Alternator Nissan Pathfinder, Gear Box Tractor

GR6012
FEATURES / CARACTERÍSTICAS: Needle Bearing

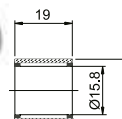
APPLICATION / APLICACIÓN: For starter Bosch and Mercedes-Benz.

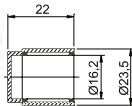
REPLACES / REEMPLAZA:
Bosch: F 006 919 232; **INA:** SCE 1012

GR6013

FEATURES / CARACTERÍSTICAS: Needle Bearing
APPLICATION / APLICACIÓN: For starter Bosch and Mercedes-Benz Till 7C
REPLACES / REEMPLAZA: Bosch: 2 000 910 013

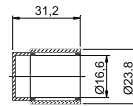
GR6171

FEATURES / CARACTERÍSTICAS: Needle Bearing
APPLICATION / APLICACIÓN: For alternator Delco 55AMP.
REPLACES / REEMPLAZA: Delco: 9437171

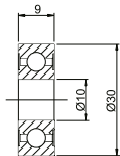
GR6200
2RS/C3 (DDU)

FEATURES / CARACTERÍSTICAS: Ball Bearing
APPLICATION / APLICACIÓN: For alternator Bosch/Wapsa. F350, F600, F700, F750, Ford Willis, Toyota 80235 For various industrial applications.

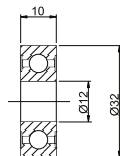
GR6201
2RS/C3 (DDU)

FEATURES / CARACTERÍSTICAS: Ball Bearing
APPLICATION / APLICACIÓN: For alternator Mercedes-Benz and light series (Fiat, GM, VW) - Bosch and Wapsa (lado colector).

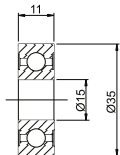
GR6202
2RS/C3 (DDU)

FEATURES / CARACTERÍSTICAS: Ball Bearing
APPLICATION / APLICACIÓN: For alternator (BOSCH - WAPSA) and starter(JE) (Bosch - Mercedes-Benz/VW).

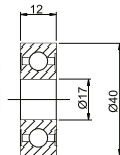
GR6203
2RS/C3 (DDU)

FEATURES / CARACTERÍSTICAS: Ball Bearing
APPLICATION / APLICACIÓN: For alternator Non comercial vehicles

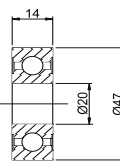
GR6204
2RS/C3 (DDU)

FEATURES / CARACTERÍSTICAS: Ball Bearing
APPLICATION / APLICACIÓN: For alternator Wapsa F1000, F4000 e Cargo.

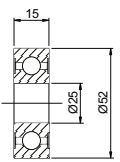
GR6205
2RS/C3 (DDU)

FEATURES / CARACTERÍSTICAS: Ball Bearing
APPLICATION / APLICACIÓN: Automotive and industrial Application

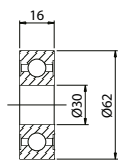
GR6206
2RS/C3 (DDU)

FEATURES / CARACTERÍSTICAS: Ball Bearing
APPLICATION / APLICACIÓN: Automotive and industrial Application

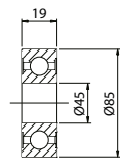
GR6209
2RS/C3 (DDU)

FEATURES / CARACTERÍSTICAS: Ball Bearing
APPLICATION / APLICACIÓN: Automotive and industrial Application

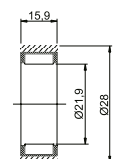
GR6216

FEATURES / CARACTERÍSTICAS: Needle Bearing
APPLICATION / APLICACIÓN: For starter Bosch and Mercedes-Benz(JE)
REPLACES / REEMPLAZA: INA: HK2216

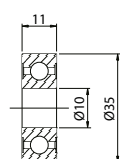
GR6300

FEATURES / CARACTERÍSTICAS: Ball Bearing
APPLICATION / APLICACIÓN: Industrial Application

GR6301

2RS/C3 (DDU)

FEATURES / CARACTERÍSTICAS: Ball Bearing

APPLICATION / APLICACIÓN: For front wheel - Motorcycles For various industrial applications.

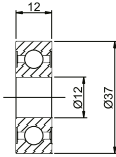

GR6302

2RS/C3 (DDU)

FEATURES / CARACTERÍSTICAS: Ball Bearing

APPLICATION / APLICACIÓN: For sheave MB 00625006302, for back wheel - Motorcycle. For various industrial applications.

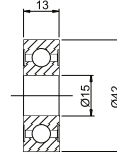

GR6303

2RS/C3 (DDU)

FEATURES / CARACTERÍSTICAS: Ball Bearing

APPLICATION / APLICACIÓN: For alternator Mercedes-Benz LP 321, L/LO-608/708/709, LO-812, L-912, 1111, 1113, 1114, 1214, 1313, 1314, 1414, 1513, 1514, 1519, 1520, 1614, 2013, 2015, 2213, 2214, 2219, 2220, LS 1524, 0370, 0371(lado polia).

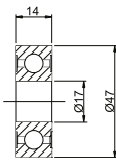

GR6304

FEATURES / CARACTERÍSTICAS: Ball Bearing

APPLICATION / APLICACIÓN: Engine VW, Industrial Application, Trucks

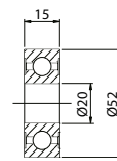

GR6305

2RS/C3 (DDU)

FEATURES / CARACTERÍSTICAS: Ball Bearing

APPLICATION / APLICACIÓN: For alternator Bosch - Lifter and Tractors Caterpillar. For various industrial applications.

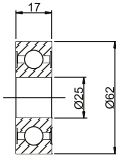

GR6306

2RS/C3 (DDU)

FEATURES / CARACTERÍSTICAS: Ball Bearing

APPLICATION / APLICACIÓN: For alternator Bosch T1/HD1 75 a 105A, for back wheel Townner. For various industrial applications.

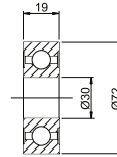

GR6403

2RS/C3 (DDU)

FEATURES / CARACTERÍSTICAS: Ball Bearing

APPLICATION / APLICACIÓN: For alternator Bosch/MBB/Scania/Volvo (lado polia).

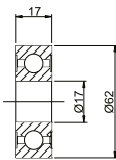

GR6713

FEATURES / CARACTERÍSTICAS: Needle Bearing

APPLICATION / APLICACIÓN: For Alternator Wapsa

REPLACES / REEMPLAZA:

INA: Bk45713

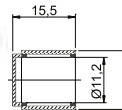

GR6716

FEATURES / CARACTERÍSTICAS: Needle Bearing

APPLICATION / APLICACIÓN: For Alternator Bosch 75A.

REPLACES / REEMPLAZA:

Bosch: 9 121 456 113; **INA:** NK 17/16X

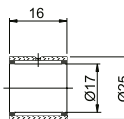

GR6816

FEATURES / CARACTERÍSTICAS: Needle Bearing

APPLICATION / APLICACIÓN: ...

REPLACES / REEMPLAZA:

Bosch: 2 000 910 002; **INA:** HK 1816

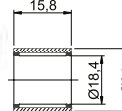

GR6853

FEATURES / CARACTERÍSTICAS: Needle Bearing

APPLICATION / APLICACIÓN: For Alternator Wapsa Opala, Monza, D20.

REPLACES / REEMPLAZA:

INA: BK45853

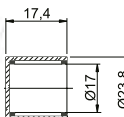

GR6903

2RS/C3 (DDU)

FEATURES / CARACTERÍSTICAS: Ball Bearing

APPLICATION / APLICACIÓN: HITACHI OSGR starters on Chevrolet, Isuzu, Nissan, Nissan Forklift, Pontiac, Thermoking, Volvo (armature)

REPLACES / REEMPLAZA:

PFI: 6903-2RS C3; **Hitachi:** 2114-35502;

Nissan: 23338-M4900;

Thermoking: 77-1578

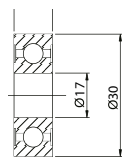

GR6904DW

2RS/C3 (DDU)

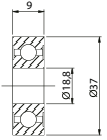
FEATURES / CARACTERÍSTICAS: Ball Bearing

APPLICATION / APLICACIÓN:

Mitsubishi OSGR starters

REPLACES / REEMPLAZA:
PFI: 6904DW; **Cargo:** 140412;

Delco: 22516191;

Mitsubishi: M410X14171

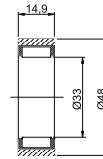
GR6916

FEATURES / CARACTERÍSTICAS: Roller Bearing

APPLICATION / APLICACIÓN:

For Alternator KB

REPLACES / REEMPLAZA:
Bosch: 2 000 910 005; **INA:** F-91916

GR62201

2RS/C3 (DDU)

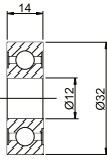

FEATURES / CARACTERÍSTICAS: Ball Bearing

REPLACES / REEMPLAZA: Scania: 1314205

APPLICATION / APLICACIÓN: For alternatorS Mercedes-Benz 355, 362, 364, 608, 708, 709, 912, 1113, 1114, 1116, 1519, 1520, 1524, 1525, 1614, 1618, 1819, 1820, 1924, 1929, 1932, 1934, 2013, 2014, 2016, 2018, 2213, 2214, 2215, 2219, 2220, Scania 112K, 112S, 112R, 112T, 142E, 142MA, Volvo, Bus and Trucks.

GR62202

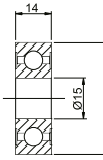
2RS/C3 (DDU)

FEATURES / CARACTERÍSTICAS: Ball Bearing

APPLICATION / APLICACIÓN: For alternator (Bosch - Scania/Mercedes-Benz -1938) For various industrial applications.

GR62303

2RS/C3 (DDU)

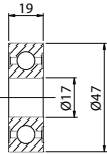
FEATURES / CARACTERÍSTICAS: Ball Bearing

APPLICATION / APLICACIÓN: Industrial application, Alternator Magnetti Marelli Fiat, trucks, Tractors

GR62304/17

2RS/C3 (DDU)

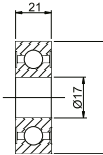
FEATURES / CARACTERÍSTICAS: Ball Bearing

APPLICATION / APLICACIÓN: For alternator Bosch MBB, Scania, Volvo. For various industrial applications.

GR63001

2RS/C3 (DDU)

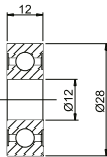
FEATURES / CARACTERÍSTICAS: Ball Bearing

APPLICATION / APLICACIÓN: For alternator Tipo, Tempra, F250, F1000 (HSD), Ranger, S10 2.5, Magneti Marelli - Tempra.

GR101011

2RS/C3 (DDU) // NEW //

FEATURES / CARACTERÍSTICAS: Ball Bearing

APPLICATION / APLICACIÓN: Bearing Air conditioning. Several Nachi 1952> 2020

GR16100ZZ

// NEW //

FEATURES / CARACTERÍSTICAS:
APPLICATION / APLICACIÓN: Bearing To bearing Rear Match Engine Iskra Deutz Perkins Jungheinrich JCB Caterpillar Bomag Hamm JCB Volvo Atlas Copco Genie Haulotte

GR304720

// NEW //

FEATURES / CARACTERÍSTICAS: Ball Bearing

APPLICATION / APLICACIÓN: Bearing Air conditioning. FIAT: Palio Fire 2002> 2020

GR30BD5020

2RS/C3 (DDU) // NEW //

FEATURES / CARACTERÍSTICAS: Ball Bearing

APPLICATION / APLICACIÓN: Bearing Air conditioning. Focus Compressor Delphi CVC, Sanden 2001> 2020

GR30BGS10G

2RS/C3 (DDU) // NEW //

FEATURES / CARACTERÍSTICAS: Ball Bearing

APPLICATION / APLICACIÓN: Bearing Air conditioning. Several dense 10PA15 / 17 1951> 2020

GR35BG05S10DST2

 2RS/C3 (DDU) // **NEW** //

FEATURES / CARACTERÍSTICAS: Ball Bearing
APPLICATION / APLICACIÓN: Bearing Air conditioning Miscellaneous: Citroën, Peugeot, GM, Honda, Nissan, Chrysler, Kia, Hyundai, Sanden, Seltec, Kiki

GR35BG05S7DL

 2RS/C3 (DDU) // **NEW** //

FEATURES / CARACTERÍSTICAS: Ball Bearing
APPLICATION / APLICACIÓN: Bearing Air conditioning: GM: Corsa 1994> 2012, Meriva 2002> 2012 Montana 2004> 2020; Mitsubishi Miscellaneous

GR38BG05S6DST2

 2RS/C3 (DDU) // **NEW** //

FEATURES / CARACTERÍSTICAS: Ball Bearing
APPLICATION / APLICACIÓN: Bearing Air conditioning. Fiat Palio 1.0 1996> 2020, Siena 1.0 1998> 2016; VW: Gol 1.0 1996> 2020, Parati 1.0 1998> 2004

GR40BGS11DS

 2RS/C3 (DDU) // **NEW** //

FEATURES / CARACTERÍSTICAS: Ball Bearing
APPLICATION / APLICACIÓN: Bearing Air conditioning GM: All Less Kadett 1.0 1989> 1998 Fiat Palio All Less 1.0 1996> 2020 All Less Tempra 1.0 1992> 1999 All Less Uno 1.0 1985> 2020 FORD: Escort 1985> 2003 TOYOTA: Bandeirante 1979> 2001. VW: Goal 1981 Parati 1985> 2013 All Less Quantum 1.0 1985> 2002 All Less Santana 1.0 1985> 2006 Several Mercedes-Benz, Volvo Trucks 1951> 2020

GR6559469

 2RS/C3 (DDU) // **NEW** //

FEATURES / CARACTERÍSTICAS: Ball Bearing
APPLICATION / APLICACIÓN: Bearing Air conditioning Several Chrysler, Mazda 1951> 2020

GR83A693A

 2RS/C3 (DDU) // **NEW** //

FEATURES / CARACTERÍSTICAS: Ball Bearing
APPLICATION / APLICACIÓN: Bearing Air conditioning Several Toyota, Mazda, Suzuki 1951> 2020

GR B8 23D

2RS/C3 (DDU)

FEATURES / CARACTERÍSTICAS: Ball Bearing
APPLICATION / APLICACIÓN: Alternator Mitsubishi S930P 61201, SC8A05LHI, Tawner

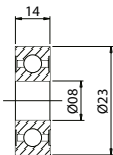
GR B8 74D

2RS/C3 (DDU)

FEATURES / CARACTERÍSTICAS: Ball Bearing
APPLICATION / APLICACIÓN: Mitsubishi: IR/ IF Alternators on Dodge, Mitsubishi, Nissan, Plymouth
REPLACES / REEMPLAZA:
PFI: B8-74D; **NSK:** B8-74T12, B8-74D;
Cargo: 140231; **Mitsubishi:** S930P17170

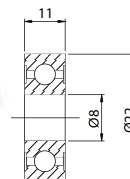
GR B8 79D

2RS/C3 (DDU)

FEATURES / CARACTERÍSTICAS: Ball Bearing
APPLICATION / APLICACIÓN: Mando: Alternators on Dodge, Eagle, Honda, Hyundai, Mazda, Mitsubishi, Nissan, Plymouth, Subaru, Toro; Mitsubishi: Alternators on Dodge, Eagle, Honda, Hyundai, Mazda, Mitsubishi, Nissan, Plymouth, Subaru, Toro
REPLACES / REEMPLAZA:
VHL: B8-79D; **PFI:** B8-79D; **NSK:** B8-79D, B8-79T12; **Cargo:** 140232; **Chrysler:** MD611150; **Mazda:** F81124503;
Mitsubishi: MD611150, S930P17970, S930P17971; **Nissan:** 23120-V5511

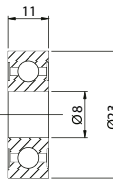
GR B8 85D

2RS/C3 (DDU)

FEATURES / CARACTERÍSTICAS: Ball Bearing
APPLICATION / APLICACIÓN: Alternator Ford E7GZ- 10A304-A, Mitsubishi S930P63670, Motorcraft GEE-312, Kia

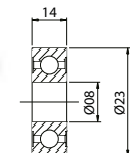

GR B10 46D

 2RS/C3 (DDU) // **NEW** //

FEATURES / CARACTERÍSTICAS: Ball Bearing

APPLICATION / APLICACIÓN:

 Hitachi Alternator: 6900BPL
 Alternator: John Deere

GR B10 50D

2RS/C3 (DDU)

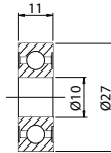

FEATURES / CARACTERÍSTICAS: Ball Bearing

APPLICATION / APLICACIÓN: Alternator

 Hitachi 6000G, 6000HL, Nissan 23120-58S01,
 Subaru 23721-AA010, Gol GII / GIII / G IV,
 John Deere

GR B15 69D

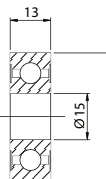
2RS/C3 (DDU)



FEATURES / CARACTERÍSTICAS: Ball Bearing

APPLICATION / APLICACIÓN: Mitsubishi: A2T Series Alternator

REPLACES / REEMPLAZA:
PFI: B15-69D; **NSK:** B15-69B-8T85G;
Cargo: 140434; **Hitachi:** 6202NCT;
Mitsubishi: S930P18301, S930P18370,
 S930P64301, S930P64370; **Nissan:** 23129-05E06; **NSK:** B1569T1XDDW1NCXCE,
 B15-69BT1X, B15-69D; **SKF:** 6202NCD

GR B15 70D

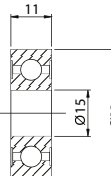
2RS/C3 (DDU)

FEATURES / CARACTERÍSTICAS: Ball Bearing

APPLICATION / APLICACIÓN: Denso Alternator; Hitachi: LR170-410, LR170-418; Mitsubishi: A3T02478

REPLACES / REEMPLAZA:
PFI: B15-70D;
Nippondenso: 949100-3670;
NSK: B15-70T1X

GR B15 83D

 2RS/C3 (DDU) // **NEW** //

FEATURES / CARACTERÍSTICAS: Ball Bearing

APPLICATION / APLICACIÓN:

 Chrysler alternator: MD 611410
 Ford alternator: E8PZ-10094-A
 Mazda alternator: FE2H-18W27
 Mitsubishi alternator: S930P18470
 Motorcraft alternator: GEE-318
 Nissan alternator: 23120-20P11

GR B15 86D
FEATURES / CARACTERÍSTICAS: Ball Bearing

APPLICATION / APLICACIÓN: Alternator
 Chrysler MD611397, Ford E8GY- 10A303-A,
 Mazda F811-18-W27, Mitsubishi TMB303LUX,
 S930P63070, Motorcraft GEE 316, Nissan
 23120-58S11

GR B17 52D

2RS/C3 (DDU)

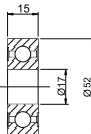
FEATURES / CARACTERÍSTICAS: Ball Bearing

APPLICATION / APLICACIÓN: alternador KIA Poong Sung.

GR B17 99

2RS/C3 (DDU)

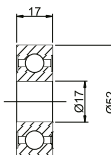
FEATURES / CARACTERÍSTICAS: Ball Bearing

APPLICATION / APLICACIÓN: For alternator VW

GR B17 126

2RS/C3 (DDU)

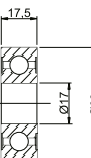
FEATURES / CARACTERÍSTICAS: Ball Bearing

APPLICATION / APLICACIÓN: For alternator Bosch MBB 55 A.

GR B17 127

2RS/C3 (DDU)

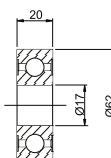
FEATURES / CARACTERÍSTICAS: Ball Bearing

REPLACES / REEMPLAZA: Scania: 1387609
APPLICATION / APLICACIÓN: For alternator Bosch - MB, Scania 114/124, Volvo.

GRF95066

 C3 // **NEW** //

FEATURES / CARACTERÍSTICAS: Ball Bearing

APPLICATION / APLICACIÓN: Alternator: Bosch/Wapsa (75 / 105 / 140A)

REPLACES / REEMPLAZA:
BOSCH: 1 900 910 024, 2 120 910 001
FAG: NU202ETVP2
INA: F-95066
SKF: NU202ECP



ELECTRICAL SPARE PART | PIEZA ELÉCTRICA

ALTERNATOR | ALTERNADOR

GA10001

FEATURES / CARACTERÍSTICAS: 28V / 80AMP
 REPLACES / REEMPLAZA:
 0124555001/015/032
 APPLICATION / APLICACIÓN:
 El Detalle: OA Series; MB: LS1938, LS2638, bus.

GA10002

FEATURES / CARACTERÍSTICAS: 28V / 80AMP
 REPLACES / REEMPLAZA:
 124555002
 APPLICATION / APLICACIÓN:
 El Detalle: OA Series; MB: 1215, 1618, 712C, 914, L1218, L1418, L1622, O500M, O500U, OF1417, OF1620, OF1721, OH1420, OH1621L.

GA10007

FEATURES / CARACTERÍSTICAS: 28V / 80AMP
 REPLACES / REEMPLAZA:
 124555007
 APPLICATION / APLICACIÓN:
 ALTERNATOR SCANIA: 124R 24V 100AMP

GA10013

FEATURES / CARACTERÍSTICAS: 24V / 110AMP
 REPLACES / REEMPLAZA:
Bosch: 0 124 555 017, 0 124 655 008, 0 124 655 012, 0 124 655 019, 0 986 047 440, 0 986 049 350; **Cargo:** 115488; **Transpo:** 23876N; **Volvo:** 20466317, 20849352, 21429787
 APPLICATION / APLICACIÓN:
RENAULT: 460 E./500 E. TECH MAGNUM 12.8L 2006>2009, 460/500 KERAX 12.8L 08;
VOLVO: FH 16 540/FH 16 550/FH 16 580/FH 16 610/FH 16 660 16.0L 2003>2006, FH 400/FH 440/FH 480/FH 500/FH 520/FM 360/ FM 400/ FM 440/ FM 480/ FM 500 12.8L 2005>2009, FM 9 260/FM 9 300/FM 9 340/FM 9 380 9.0L 2001>2005, FM 9 300/ FM 9 340/ FM 9 380 9.4L 05

GA10016

FEATURES / CARACTERÍSTICAS: 24V / 100AMP
 REPLACES / REEMPLAZA:
Bosch: 0 124 655 001, 0 124 655 002, 0 124 655 004, 0 124 655 016, 0 124 655 023, 0 124 655 097, 0 986 042 390, 0 986 042 400, 0 986 042 410, 0 986 045 290, 0 986 048 110
 APPLICATION / APLICACIÓN:
Mercedes Benz: Atego Series 1994>2004, Atego II Series 2004>2013, Axor I 2001>2004, Axor II 2004>2016, Actros 1996>2002, Actros MP2/MP3 2002>, Econic 1998>, Unimog 2000>, Zetros 2008>, Citaro 1998>, Conecto 2001>, Integro 1996>, Tourino 2003>, Intouro 2005>, G-Class 1989>, Vario 1996>

GA10019

FEATURES / CARACTERÍSTICAS: 14V / 90AMP
 REPLACES / REEMPLAZA:
 123310019
 APPLICATION / APLICACIÓN:
VW: Caddy 1.4L com motor APQ 1997>2003, Caddy 1.6L Pichup com motor AEE 1996>2000, Caravelle T4 2.5L Syncro com motor AAF 1992>1993, Caravelle T4 2.5L Syncro com motor ACU 1994>1996, Eurovan 2.5L com motor AAF 1991>1993, Eurovan 2.5L com motor ACU 1994>1996, Gol II 1.0 Mi 1997, Gol III 1.0Mi 16V 1997, Golf III 1.8 com motor ABS 1991>1992, Parati II 1.0 Mi 1997, Parati II 1.0 Mi 16V 1997, Passat 1.8L com motor ADZ 1994>1997, Passat 1.9L D com motor 1Y 1989>1993, Passat 1.9L TD com motor AAZ 1991>1997, Passat 1.9L TDI com motor AFN 1996>1997, Passat 1.9L TDI com motor AHU 1996, Passat 2.0L com motor 2E 1990>1994, Passat 2.0L com motor ABF 1994>1997, Passat 2.0L com motor ADY 1994>1995, Passat 2.0L com motor AEP 1994>1997, Passat 2.0L com motor AGG 1995>1997, Passat Variant 1.8L com motor AAM 1990>1997, Passat Variant 1.8L com motor ABS 1991>1994, Passat Variant 1.8L com motor ADZ 1994>1997, Transporter T4 2.5L com motor AAF 1990>1993, Transporter T4 2.5L com motor ACU 1994>1996, **VW/ SEAT:** Cordoba 1.8 com motor ACC 1995>2002, Ibiza 1.8 com motor ACC 1995>1999.

GA10034

FEATURES / CARACTERÍSTICAS: 28V / 80AMP

REPLACES / REEMPLAZA:

Bosch: 0124555034

APPLICATION / APLICACIÓN:

SCANIA: F113 HL, P114

GA10035 // NEW //

FEATURES / CARACTERÍSTICAS: 12V / 150AMP

REPLACES / REEMPLAZA:

Bosch: 0 124 525 035; **Peugeot / Citroën:** 5705NH, 9650358580, 5702 C2, 5702 E0 (C), 5702 E1, 5702 E2, 5702 E3 (C), 5702AR, 5702E0, 5702E3, 5705 AG, 5705 AR, 5705 AS, 5705 EY, 5705AS, 5705ES, 5705EX, 96460654, 96463218; **Fiat:** 71733552, 71748885, 71783849, 71784025, 9644103580, 9646065480, 9646321780, 9646321880; **Cargo:** 113640, 116067; **Transpo:** 23301N

APPLICATION / APLICACIÓN:

Citroën: Berlingo 1.6 Diesel 2008->, C2 1400 2003>2010, C3 1400 2002>2010, C3 1600 2005>2010, C3 Pluriel 1400 2004>2010, C4 1600/2000 2004>2010, C4 Coupe 1.6 2004>2010, C4 Grand Picasso 1600 2006>2010, C5 1600 2004>2010;

Peugeot: Expert Tepee 1600/2000 2007>2012, Partner Combi 1600 2005>2010, Partner Tepee 1600 2008>2012;

Fiat: Ducato 11 2000 2004>2010, Ducato 15 2000 2004>2010, Scudo 1600 2007>2012, Scudo 2000 2000>2007

GA10044

FEATURES / CARACTERÍSTICAS: 28V / 80AMP

REPLACES / REEMPLAZA:

124555044

APPLICATION / APLICACIÓN:

MB: 1318, 1618, 1728, 2423, 2428, 712C, 914C, 915, Accelo, Atego, Axor, L1620, O500M, O500R, O500U, OF1417, OF1418, OF1722, OH1418.

GA10055

FEATURES / CARACTERÍSTICAS: 14V / 135AMP

REPLACES / REEMPLAZA:

Bosch: 0 120 468 055; **Cargo:** 112773; **WAI:** 12162N; **AS-PL:** A0112; **Prestolite:** 860567; **Mahle Original:** MG 575;

Delco: 93033; **Lucas:** LRA03294

APPLICATION / APLICACIÓN:

Case Combine: 2144 1995-1998, 2166 1995-1998, 2188 1995-1998, 2344 Cummins 5.9L 1998-2002, 2366 Cummins 8.3L 1998-2003, 2377 0000, 2388 Cummins 8.3L 1998-2003, 2577 0000, 2588 0000, 5088 Case 8.3L 0000, 6088 Case 8.3L 0000, 7088 Case 9.0L 0000.

Case Cotton Picker: 2155 6TA-830 1995-1998, 2555 0000, CPX420 2005-2006.

Case Floater: FLX3010 Case 8.3L 2004-2006, FLX3300B Case Engine 2000-2003, FLX3330B Case Engine 2000-2002, FLX3510 Case 9.0L 2004-2006, FLX4300 Case 8.3L 2003, FLX4510 Case 9.0L 2004-2006, Titan 3020 549 Diesel 0000, Titan 3520 549 Diesel 0000, Titan 4020 549 Diesel 0000, Titan 4520 549 Diesel 0000.

Case Skid Steer Loader: 420 6-505 Diesel 0000.

Case Sprayer: SPX4260 2001-2004, SPX4260 Patriot 1999-2001, SPX4410 2004-2006.

Case Tractor: Farm MX180 6-505 Diesel 0000, MX200 6-505 Diesel 0000, MX210 0000, MX220 6-505 Diesel 0000, MX230 0000, MX240 6-505 Diesel 0000, MX255 6-505 Diesel 2002-2005, MX270 6-505 Diesel 0000, STX275 6-505 Diesel 2002-2005, STX325 6-540 Diesel 2002-2005, STX375 6-912 Diesel 2002-2005, STX375QT 6-912 Diesel 2002-2005, STX425 6-912 Diesel 2002-2005, STX425QT 6-912 Diesel 2002-2005, STX440 6-912 Diesel 0000, STX440QT 6-912 Diesel 0000, STX450 6-912 Diesel 2002-2005, STX450QT 6-912 Diesel 2002-2005, STX500 6-912 Diesel 0000.

John Deere Feller Buncher: 653E 0000, 653G 6068T Diesel 0000, STX500QT 6-912 Diesel 0000.

John Deere Loader: 624G 0000, 644G 0000.

John Deere Skidder: 540E 4045 Diesel 0000, 540G 0000, 540G-II 0000, 548E 0000, 548G 0000, 548G-II 0000, 640E 6068 Diesel 0000, 640G 0000, 640G-II 0000, 648E 6068 Engine 0000, 648G 6068 Engine 0000, 648G-II 0000, 660D 0000, 740E 6076 Engine 0000, 740G 0000, 748E 6076 Engine 0000, 748G 0000, 748G-II 0000, 848G 0000.

John Deere Tool Carrier: 544G 0000, 544G 6059 Diesel 0000

New Holland Agricultural Tractor: TG210 6 Cyl. 8.27L 8268cc 504cid 2002-2005, TG230 6 Cyl. 8.27L 8268cc 504cid 2002-2005, TG255 6 Cyl. 8.27L 8268cc 504cid 2002-2005, TG285 6 Cyl. 8.27L 8268cc 504cid 2002-2005, TJ275 6 Cyl. 8.27L 8268cc 504cid 2001-2005, TJ325 6 Cyl. 8.85L 8819cc 538cid 2001-2002, TJ375 6 Cyl. 14.95L 14948cc 911cid 2001-2006, TJ425 6 Cyl. 14.95L 14948cc 911cid 2001-2006, TJ450 6 Cyl. 14.95L 14948cc 911cid 2001-2006, TJ500 6 Cyl. 14.95L 14948cc 911cid 2004-2005

Tigercat Feller Buncher: 720D 2001-2006, 724D 2001-2006, 853 1996-2002, 853E 1996-2002.

GA10059 // NEW //

FEATURES / CARACTERÍSTICAS: 12V / 150AMP

REPLACES / REEMPLAZA:

Bosch: 0 121 615 002, 0 125 711 017, 0 125 711 059; **Peugeot/ Citroën:** 9676143580, 5705; **Fiat:** 965814468, 9658144680, 965991808, 9659918080; **Ford:** 352430, 1404791, 1572736, 1581843, 1712779, 1747021, 1762862, 4M5T10300AB, 6C1T-10300-BA, 6C1T-10300-BB, 6C1T-10300-BC, 6C1T-10300-BD, AC1T-10300-BA, AC1T-10300-BB, REAC1T-10300-BB; **Cargo:** 113958;

Transpo: 23925N

APPLICATION / APLICACIÓN:

FORD: Transit Box 2.2 TDCi 2006>2014, Tourneo Connect 2.2 TDCi 2006>2015; **FIAT:** Ducato Box 2.2 2006>2012, Ducato Bus 2.2 2006>2012, Ducato 2200 2006>2010; **PEUGEOT:** Boxer 2.2 Hdi 2006>2015; **CITROËN:** Jumper Box 2.2 2006>2012, Jumper Bus 2.2 2009>2011, Jumper Platform 2.2 2006>2012, Relay 2200 2006>2010

GA10091

FEATURES / CARACTERÍSTICAS: 12V / 120AMP

REPLACES / REEMPLAZA:

Bosch: 0 986 049 091

Mitsubishi: A003TB2691, A003TB2691C, A003TB2691D, A003TB2691E, A003TB2691F, A003TB2691J, A003TB2691K

Citroën: 5705EC, 5705GQ

Peugeot: 9640088080, 9642124980

APPLICATION / APLICACIÓN:

CITROËN: Berlingo 1.4/1.6 16V 2008>2012, C4 1.4/1.6/2.0 2004>2010, C5 1.8/2.0 16V 2001>2010, C8 2.0/2.2 2002>2010, Xsara Picasso 1.8 16V 2000>2010

PEUGEOT: 207 1.4 16V KFU/1.6 16 V NUF 2006>2010, 307 2.0 16V 2001>2010, 407 2.2 16V 2004>2010, 607 2.2 16V 2000>2005, 807 2.0/2.2 2002>2010, Partner Tepee 1.6 16V 2008>2012

GA10118

FEATURES / CARACTERÍSTICAS: 14V / 90AMP

REPLACES / REEMPLAZA:

124325118

APPLICATION / APLICACIÓN:

Agrale: 4500D, 5000D, 6150, 7000TDX; **Agrale-Deutz:** 6150TD, BX100TD, BX4.100TD, MA 7.5T; **Fiatallis:** FB80;

GM-Chevrolet: C series, S10; **MWM:** D series; **Müller:** RT62H, RT82H, TM12, TM14, VAP55; **Puma:** 7900, 914; **Valmet:** 1180; **VW:** 13-150, 13-180, 13-190, 15-180, 15-190, 17-210, 17-220, 17-310, 23-210, 23-220, 26-220, 26-260, 26-310, 7-110, 7-120, 8-120, 8-150, 9-150.

GA10131

FEATURES / CARACTERÍSTICAS: 28V / 65AMP

REPLACES / REEMPLAZA:

120468131

APPLICATION / APLICACIÓN:

Scania: F94, L94, P114, PR114, R114, R124/360, R124/400, R124/420, R144/460, R144/530, R164/480, R164/580, DS serie. DSC serie, DSI serie, T114, T124/360, T124/400, T124/420, T144/460, T144/530.

GA10144

FEATURES / CARACTERÍSTICAS: 28V / 45AMP

REPLACES / REEMPLAZA:

9120080144

APPLICATION / APLICACIÓN:

Atlas Copco: AX430; **Case:** W36D, W36E; **Fiatallis:** AD14; **Scania:** N855, N855C, NT855, NT855A, NT855C, NTA855, NTA855C, NTTA855, DS serie, DSC serie, DSI serie, T112. DN serie.

GA10182

FEATURES / CARACTERÍSTICAS: 14V / 55AMP

REPLACES / REEMPLAZA:

9120080182

APPLICATION / APLICACIÓN:

Agrale: 8500; **Case:** W36; **Komatsu:** D 30 E; **Massey Ferguson:** MF1630, MF3640, MF4780, MF5650, MF6845, MF6855, MF6865; **Maxion:** Ideal 9070, Ideal 9090.

GA11100



FEATURES / CARACTERÍSTICAS: 24V / 70AMP

REPLACES / REEMPLAZA:

Delco: 10459026, 1117900, 19010108, 19010199

Cummins: 3675201RX, 3920617

APPLICATION / APLICACIÓN:

CONSOLIDATED DIESEL ENGINE HEAVY DUTY: 4B 3.9L 1992, 6B 5.9L 1992, 6C 8.3L 1992

CUMMINS ENGINES ENGINE MEDIUM DUTY: K Series 1991>1992

TIMBERJACK FELLER BUNCHER: 2618/2628 Cummins 8.3L Diesel 1995, 608 Cummins 5.9L Diesel 1995, 618/628 Cummins 8.3L Diesel 1995

TIMBERJACK MISC. EQUIPMENT: 608 Harvester 1995

VOLVO EXCAVATOR: EC140 Cummins B3-9C 1995, EC210 Cummins B5-9C, EC240 Cummins C8-3C, EC290 Cummins C8-3C, EC360 Cummins M11C, EC460 Cummins M11C

GA12418 // NEW //



FEATURES / CARACTERÍSTICAS: 12V / 70AMP

REPLACES / REEMPLAZA:

Hitachi: LR170-418, LR170-418B, LR170-418C, LR170-418CN; **Chvrolet:** 10459448, 94052404; **Isuzu:** 2912760000, 8970237331;

AS Poland: A2049; **Transpo:** 12097N; **Cargo:** 113413

APPLICATION / APLICACIÓN:

CHEVROLET: W3500 Tiltmaster 3.9 1994>1996, W3500 Tiltmaster 4 Cyl. 3.9L 236cid 1994, W3500 Tiltmaster L4 3.9L 236cid 1995-1996, W4500 Tiltmaster 3.9 1990>1998, W5500 Tiltmaster 3.9 1992>1996;

ISUZU: W6 Isuzu 3.9 1992>1996, W7 Isuzu 3.9 1992>1996, NPR L4 3.9 1990>1997

GA12421



FEATURES / CARACTERÍSTICAS: 12V / 50AMP

REPLACES / REEMPLAZA:

Hitachi: LR150-421, LR150-421C, LR150-434, LR150-434B, LR150-441, LR150-441C, LR150-441E, LR150-442, LR150-444B, LR150-448, LR150-449, LR150-449B, LR150-449C, LR150-453, LR150-453B, LR150-78B, LR150-78C, LR150-78E

APPLICATION / APLICACIÓN:

ISUZU: Campo 2.5 DIESEL TFR 1991>1994 / 2.50 D 1989>1990 / 2.5L DIESEL 1989, FASTER 2.50 1989>1990, Trooper 2.80 TD 1987>1991 / 2.8L DIESEL 1987>1988

OPEL: Campo 2.50 D 1991>1994 / 2.50 TD 1994 / 2.5L DIESEL 1989>1997 / 3.1 DIESEL TURBO 1995>2001 / 3.10 TD 1992>1995 / 3.1L DIESEL 1992>1995, Monterey A 3.10 TD / 3.1L DIESEL 1991>1997

VAUXHALL: Brava 2.50 D 1990>1994 / 2.5L DIESEL 1990>1998, Monterey 3.10 TD 1991>1998, Monterey A 3.1L DIESEL 1991

GA12501 // NEW //



FEATURES / CARACTERÍSTICAS: 24V / 60AMP

REPLACES / REEMPLAZA:

Isuzu: 8-97351-574-0, 9873325020;

Hitachi: LR280-501, LR280-506, LR280-508

Transpo: 12718N

APPLICATION / APLICACIÓN:

Isuzu Engine Heavy Duty: 4HE1/4HF1/4HK1 Engine 1994>2001

GA12504 // NEW //



FEATURES / CARACTERÍSTICAS: 12V / 100AMP

REPLACES / REEMPLAZA:

Hitachi: LR1100-502, LR1100-502A, LR1100-502B, LR1100-502C, LR1100-502D, LR1100-502E, LR1100-502F, LR1100-502G, LR1100-502H, LR1100-502I, LR1100-502J, LR1100-502K, LR1100-502L, LR1100-502M, LR1100-502MD, LR1100-502N, LR1100-504, LR1100-504A, LR1100-504B, LR1100-504C, LR1100-504D, LR1100-504E, LR1100-504F, LR1100-505, LR1100-505A, LR1100-505B, LR1100-505C, LR1100-505D, LR1100-505E; **Chevrolet:** 93175799, 97189113, 98056867; **Vauxhall:** R1530037; **Cargo:** 112271; **Transpo:** 21830N

APPLICATION / APLICACIÓN:

OPEL: Astra Van G 1700 16V 2000>2005, Corsa/Combo II 1700 16V 2001>2010, Corsa D 1700 16V 2006>2010, Meriva A 1700 16V 2003>2005, Meriva A 1.7 2003>2015;

VAUXHALL: Astra G 1.7 CDTI 2003-2005, Corsa C 1.7 2000>2015, Astra van G 1.7 2000>2015;

HONDA: Civic 1700 2002>2005, Civic MkVII 1.7 2002>2005

GA12522



FEATURES / CARACTERÍSTICAS: 24V / 60AMP

REPLACES / REEMPLAZA:

Hitachi: LR250-508, LR250-517, LR260-504B

Isuzu: 8971753901

Cargo: 114014

APPLICATION / APLICACIÓN:

ISUZU TRUCKS: Engine Serie N 4HF1 / 4HG1 / 4HJ1 1998>

GA12523

FEATURES / CARACTERÍSTICAS: 24V / 60AMP

REPLACES / REEMPLAZA:

Hitachi: LR260-502, LR260-504

APPLICATION / APLICACIÓN:

ISUZU: NPR Series 4HF1 1998>2002, NPR Series 4HG1 1998>2002, NPR Series 4HJ1 1998>2002

GA13040 // NEW //

FEATURES / CARACTERÍSTICAS: 12V / 120AMP

REPLACES / REEMPLAZA:

Valeo: SG12B040, 2542441, 2542441A, 2542441C, 2542441D; **Fiat:** 500371244; **Peugeot/ Citroën:** 5705 AF, 5705 C0, 5705 C1, 5705 EV; **Cargo:** 113247; **Transpo:** 23223N; **AS Poland:** A3053

APPLICATION / APLICACIÓN:

FIAT: Ducato 2.8 Diesel 2000>2002, Ducato Box 2.8 2000>2007, Ducato Maxi 18 2800 2000>2010;

CITROËN: Jumper Box 2.8 2000>2007;

PEUGEOT: Boxer 2800 2002>2010

GA13063 // NEW //

FEATURES / CARACTERÍSTICAS: 12V / 100AMP

REPLACES / REEMPLAZA:

Valeo: SG09B063, SG8B021, SG9B043, SG9B063, SG9B065, SG9B066, TG9B024, TG9B045, TG9B064, a13vi236, a13vi276, 2542286, 2542286A, 2542396, 2542396A, 2542396B, 2542487, 2542487A, 2542528, 2542793, 2542793A, 2542802, 2542922, 2542922A, 2542922B, 2543523, 2607210, 2607210A, 2809464; **Peugeot/ Citroën:** 5702 C7, 5702 E4, 5702 E5, 5702F2, 5705 4H, 5705 4J, 5705 4K, 5705 5A, 5705 5B (P), 5705 5C, 5705 5C (P), 5705 5T, 5705 5U, 5705 5V, 5705 6Y, 5705 6Y (P), 5705 6Z, 5705 6Z (C), 5705 7A (P), 5705 7C (P), 5705 7E (P), 5705 7F (C), 5705 AZ, 5705 GN, 57055B, 57057A, 57057C, 5705CQ, 5705KY, 9633782580, 9633782680, 9638275580, 9638275680, 9638275780, 9638275880, 9638275980, 9638827580, 9641398480, 9641398680, 9642880080, 9644904680, 9649611380, 9649611580;

Fiat: 77747925, 9638275380, 9638275480, 9649611380; **Cargo:** 113575; **Transpo:** 21493N

APPLICATION / APLICACIÓN:

PEUGEOT: 206 1100/1400/1600 1998>2005, 307 2000 2001>2010, 406 1800/2000 1999>2004, 607 2000 2001>2005, Partner Combi 1400/1600/1900/2000 2001>2005;

CITROËN: Berlingo LCV 1400/1600/1900 2000>2010, C1 1.4 2005>2014, C5 1800/2000 2001>2010, C8 2000/2200 16V 2002>2010, Nemo box/estate 1.4 2008>2009, Xsara 1600/2000 16V 2000>2005, Xsara Picasso 1800/2000 16V 2000>2010;

FIAT: Scudo box 1.9 2004>2006, Ulysse 2000 2002>2010

GA13113 // NEW //

FEATURES / CARACTERÍSTICAS: 12V / 100AMP

REPLACES / REEMPLAZA:

Valeo: TG9S113, 2614403; **Chevrolet:** 94741663

APPLICATION / APLICACIÓN:

CHEVTOLET TRUCK: Tornado L4 1.8 2011>2016

GA13475 // NEW //

FEATURES / CARACTERÍSTICAS: 12V / 110AMP

REPLACES / REEMPLAZA:

Valeo: 439475; **Mitsubishi:** A002TB6481, A002TC0981; **Nissan:** 23100BN700, 23100BN701, 2310000QA1, 2310000QA9;

Renault: 7701474416, 7711134728, 7711135331; **Transpo:** 23174N; **Cargo:** 113940, 116048

APPLICATION / APLICACIÓN:

NISSAN: Almera MK 2 Hatch/Saloon 1.5 dCi 2000->, Micra MK 3 1.5 dCi 2002>2010

RENAULT: Clio MK 2 Hatch 1.4 16V/1.6 16V/1.5 dCi 2000>, Megane MK 2 Hatch/Saloon/Estate 1.4 16V/1.6 Flex-Fuel/1.6 16V/1.5 dCi/1.9 dCi 2002>2009, Megane MK 2 Convertible 1.6 16V/1.9 dCi 2003>2009, Scenic MK 2 MPV 1.4 16V/1.6 16 V/1.5 dCi 2003>, Grand Scenic 1.6/1.5 dCi 2004>

GA15128

FEATURES / CARACTERÍSTICAS: 12V / 75AMP

REPLACES / REEMPLAZA:

Mitsubishi: A002TN1199, A002TN1199A, A002TN1199AT, A002TN1199ZT, A003T15099, A003TN0399, A003TN0499, A2TN1199, A2TN1199A, A2TN1199AT A2TN1199ZT, A3T15099, A3TN0399, A3TN0499, MD306834, MD313940, MD313942, MD327514, MD366051; **Cargo:** 112128

APPLICATION / APLICACIÓN:

MITSUBISHI: L200 2.5 turbo diesel 1996>2013, L400 2.5 Diesel, Pajero Sport 2.5 turbo diesel 1990>1997, Pajero Sport 2.5 turbo diesel 1998>2009, Montero 2.5L Turbo Diesel 1990>2001, Delica 2.5L Turbo Diesel 1986>1999

GA15399

FEATURES / CARACTERÍSTICAS: 12V / 65AMP

REPLACES / REEMPLAZA:

Mitsubishi: A002TN0399, A2TN0399, A2T81499, MD304129, MD306648

APPLICATION / APLICACIÓN:

MITSUBISHI: Delica 2.5 diesel. 1994>1996, L300 2.5 diesel 1988>1996 / 2.5L diesel 1994>1996

GA15481

FEATURES / CARACTERÍSTICAS: 12V / 110AMP

REPLACES / REEMPLAZA:

Mitsubishi: A002TB6481, A002TC0981

Valeo: 439475

Nissan: 23100BN700, 23100BN701, 2310000QA1, 2310000QA9

Renault: 7701474416, 7711134728, 7711135331;

Transpo: 23174N

APPLICATION / APLICACIÓN:

NISSAN: Almera MK 2 Hatch/Saloon 1.5 dCi 2000>, Micra MK 3 1.5 dCi 2002>2010

RENAULT: Clio MK 2 Hatch 1.4 16V/1.6 16V/1.5 dCi 2000>, Mégane MK 2 Hatch/Saloon/Estate 1.4 16V/1.6 Flex-Fuel/1.6 16V/1.5 dCi/1.9 dCi 2002>2009, Mégane MK 2 Convertible 1.6 16V/1.9 dCi 2003>2009, Scénic MK 2 MPV 1.4 16V/1.6 16 V/1.5 dCi 2003>, Grand Scénic 1.6/1.5 dCi 2004>

GA15491 // NEW //

FEATURES / CARACTERÍSTICAS: 12V / 75AMP

REPLACES / REEMPLAZA:

Mitsubishi: A003T05499, A3T05499, A3T00599, MD111932, MD141119;

Hyundai: 37300-42750

Unipoint: ALT-V039

APPLICATION / APLICACIÓN:

MITSUBISHI: Delica 2.5 1996>1998, L300 2.5L DIESEL 1986>1999, Pajero Shogun Mk1 2.5 1989>1990

HYUNDAI: Galloper 2.5, H-100, Terracan 2.5

PS: pulley with one groove

GA15492 // NEW //

FEATURES / CARACTERÍSTICAS: 12V / 75AMP

REPLACES / REEMPLAZA:

Mitsubishi: A003T05499, A3T05499, A3T00599, MD111932, MD141119; **Hyundai:** 37300-42750; **AS Poland:** A9100;

Unipoint: ALT-V039A

APPLICATION / APLICACIÓN:

MITSUBISHI: Delica 2.5 1996>1998, L300 2.5L DIESEL 1986>1999, Pajero Shogun Mk1 2.5 1989>1990

HYUNDAI: Galloper 2.5, H-100, Terracan 2.5

PS: pulley with two grooves

GA15691

FEATURES / CARACTERÍSTICAS: 12V / 120AMP

REPLACES / REEMPLAZA:

Mitsubishi: A003TB2691, A003TB2691C, A003TB2691D, A003TB2691E, A003TB2691F, A003TB2691J, A003TB2691K

Citroën: 5705EC, 5705GQ; **Peugeot:** 9640088080, 9642124980; **Bosch:** 0 986 049 091

APPLICATION / APLICACIÓN:

CITROËN: Berlingo 1.4/1.6 16V 2008>2012, C4 1.4/1.6/2.0 2004>2010, C5 1.8/2.0 16V 2001>2010, C8 2.0/2.2 2002>2010, Xsara Picasso 1.8 16V 2000>2010

PEUGEOT: 207 1.4 16V KFU/1.6 16 V NUF 2006>2010, 307 2.0 16V 2001>2010, 407 2.2 16V 2004>2010, 607 2.2 16V 2000>2005, 807 2.0/2.2 2002>2010, Partner Tepee 1.6 16V 2008>2012

GA15899

FEATURES / CARACTERÍSTICAS: 12V / 75AMP

REPLACES / REEMPLAZA:

Mitsubishi: A002T82899, A002T82899A, A002T82899AT, A002T82899ZT, A002TN0499AT, A2T82899, A2T82899A, A2T82899AT, A2T82899ZT, A2TN0499AT, MD306649, MD366050, MN137867; **Carco:** 111594

APPLICATION / APLICACIÓN:

MITSUBISHI: Pajero MK2 2.5 TD 4WD 1990>1999, Pajero MK2 soft top 2.5 TD 4WD 1990>2000, L200 2.5 1996>2007, L300 minibus 2.5 TD 1988>2004, L400 minibus 2500 TD 1995>2005, L400 van 2500 TD 1996>2005

GA16491 // NEW //

FEATURES / CARACTERÍSTICAS: 24V / 60AMP

REPLACES / REEMPLAZA:

Magneti Marelli: 63377491; **Opel:** 1204434, 13117236, 93169259; **Cargo:** 113904; **Transpo:** 23808N

APPLICATION / APLICACIÓN:

OPEL: Astra H 1900 2004>2010, Signum 1900 2004>2010, Vectra C 1900 2004>2009, Zafira B 1900 2005>2015;

SAAB: 9-3 II 1.9 2006>2010;

FORD: S Max 2.0 Flexifuel 2006>2015

PS: Alternator with two connectors

GA16551

FEATURES / CARACTERÍSTICAS: 12V / 65AMP

REPLACES / REEMPLAZA:

Magneti Marelli: 633 200 13, 633 200 23, 633 200 37, 633 201 34, 633 201 37, 633 210 40, 633 210 42, 633 210 79, 633 214 24, 633 214 28, 633 214 58, 633 215 03, 633 945 51, 633 965 60, 633 965 66, 633 965 67, 63321502, MAN 283, MAN 770, MAN 795, MAN 946F

APPLICATION / APLICACIÓN:

AGCO ALLIS TRACTOR: 8610 6-366 Same Diesel 1991>1997, 8630 6-366 Same Diesel 1991>1997; **CITROEN LCV - EUROPE VAN:** C25 1900, M705 1987>1994; **FIAT - EUROPE CAR:** Ducato Box 2.5 TD 1989>1990, Ducato Box 1.9 1991>1994, Ducato Platform/Chassis 2.5 1987>1990; **FIAT LCV - EUROPE VAN:** Ducato 1900 1989>1994, Ducato 2445 1981>1994, Ducato 2499 1984>1994; **IVECO FIAT LCV / HEAVY DUTY - EUROPE VAN:** Daily 35 2400 1985>1989, Daily 40 2500 1987>1996, Daily 45 2400 1985>1989, Daily 49 2400 1985>1989, Daily 59 2500 1989>1996

GA16600 // NEW //

FEATURES / CARACTERÍSTICAS: 12V / 75AMP

REPLACES / REEMPLAZA:

Magneti Marelli: 63303739, 63320200, 63320219, 63320253, 63320319, 63320500, 63321200, 63321233, 63321270, 63321470, 63321600, 63321712, 63321848, 63341200, 63341233, 63341712; **Fiat:** 46231693, 46407647, 46420960, 46530060, 46800158, 46843093, 91600758; **Cargo:** 111411; **Transpo:** 20984N

APPLICATION / APLICACIÓN:

FIAT: Doblo 1200 2001>2005, Doblo cargo 1.2 2001, Panda 1100 2004>2006, Punto 1100 1994>1997, Punto Van 1.1 1996>2000, Seicento 1100 1998>2004;

PEUGEOT: Expert 1.9 1996;

CITROËN: Jumpy 1.6 1995;

FORD: Sierra 1.6 1982>1986

GA16718 // NEW //

FEATURES / CARACTERÍSTICAS: 12V / 70AMP

REPLACES / REEMPLAZA:

Magneti Marelli: 63321718, 63377002, 63377006, 63377008; **Alfa Romeo:** 52003532; **Fiat:** 46554404, 46843091, 51709131, 51709133, 51714791, 51714794, 51717791, 51859037, 51859038, 71793972, 71795808; **Ford:** 1673521, 9S5110346BA, 9S5110346BB

Cargo: 113718; **Transpo:** 23800N

APPLICATION / APLICACIÓN:

FIAT: Albea 1.2 Gasoline 2002->, 500 1200/1400 2008>2012, Bravo 1400 16V 2007>2012, Doblo Box 1.4 2010, Grande punto 1.2 2005, Idea 1.4 16V 2004, Panda 1.2 2010, Stilo 1400 16V 2004>2007;

FORD: Ka 1200 2008>2012, Ka 1.2 2008>2010;

ALFA ROMEO: Mito 1.4 2008>2011

GA16826 // NEW //

FEATURES / CARACTERÍSTICAS: 12V / 120AMP

REPLACES / REEMPLAZA:

Magneti Marelli: 63321497, 63321826; **Fiat:** 46765838, 46782212, 46782213, 51859053, 60816557; **Alfa Romeo:** 46544329;

Cargo: 112386, 113336, 113943; **Transpo:** 23105N

APPLICATION / APLICACIÓN:

LANCIA: Kappa 2.4 Diesel 1996>2001, Lybra 1.9 2000>2005, Musa 1.9 2004>2015;

ALFA ROMEO: 147 1.9 16V 2000>2010, 156 1.9 1997>2006, 156 Sportwagon 1.9 16V 2002>2006, GT 1.9 2003>2010;

FIAT: Brava 1.9 1998>2001, Doblo 1.9 2005>2015, Idea 1.9 2004>2015, Marea 1.9 1999>2002, Punto 1.9 1999>2015, Stilo 1.9 2001>2008, Doblo Cargo 1.9 2001>2015

GA19143

FEATURES / CARACTERÍSTICAS: 12V / 50AMP

REPLACES / REEMPLAZA:

JUBANA: 143701001

APPLICATION / APLICACIÓN:

AMKODOR: TM-3, TO-18

BELARUS: MTZ-80, MTZ-82

GA19300 // NEW //

FEATURES / CARACTERÍSTICAS: 12V / 90AMP

REPLACES / REEMPLAZA:

Ford: 1120211, 1140696, 1151212, 1464779, 1478608, 1S7T-10300-BA, 1S7T-10300-BB, 1S7T-10300-BC, 1S7T-10300-BD, 1S7T-10300-BE, 1S7T-BC, 1S7T10C392A, 1S7T10C392AB, 1S7Z-10346-BC, 1S7Z-10346-BCRM, 1S7Z-10346-BE, RE1S7T-10300-BE; **Jaguar:** C2S-46681; **Magneti Marelli:** 063380005010, 063380006010; **Valeo:** 440192; **Visteon:** 20-150-01005, 20-150-01006; **Cargo:** 113709;

Transpo: 8440N

APPLICATION / APLICACIÓN:

JAGUAR: X-Type saloon 2.0/2.2 Diesel 2003>2009, X-Type estate 2.2 2005>2009;**FORD:** Mondeo Mk3 hatch 1.8/2.0/2.2/2.5 2000>2007, Mondeo Mk3 saloon 1.8/2.0/2.2/2.5 2000>2007, Mondeo Mk3 estate 1.8/2.0/2.5 2000>2007



ELECTRICAL SPARE PART | PIEZA ELÉCTRICA

STARTER MOTOR | MOTOR DE ARRANQUE

GA20001

FEATURES / CARACTERÍSTICAS: **5,5Kw / 24V**

REPLACES / REEMPLAZA:

BOSCH: 0.001.241.001, 0.001.261.002, 0.986.021.480;

SCANIA: 1447911

APPLICATION / APLICACIÓN:

SCANIA: Chassis Series K, P, R, T

GA20002

FEATURES / CARACTERÍSTICAS: **4,0Kw / 24V**

REPLACES / REEMPLAZA:

BOSCH: 0.001.231.002, 0.001.231.033;

DELCO REMY: 10479650, 82000168, 8200297;

MAN: 36262016003;

MERCEDES-BENZ: 0 041 518 401, 0 051 512 001, 0 061 512 201, 0 061 512 203;

APPLICATION / APLICACIÓN:

MB: 1215, 1218, 1418, 2423, 712C, 914C, 915, L1418, L1618, O500M, O500R, O500U

GA20006

FEATURES / CARACTERÍSTICAS: **6,7Kw / 24V**

REPLACES / REEMPLAZA:

BOSCH: 0.001.371.006;

SCANIA: 1357709

APPLICATION / APLICACIÓN:

SCANIA: 124 Serie, 360 Serie, 400 Serie, 420 Serie

GA20014 // NEW //

FEATURES / CARACTERÍSTICAS: **2.0 kw / 12V**

REPLACES / REEMPLAZA:

MERCEDES-BENZ: A0031515001, A0041514501, A0041516501, A0041517001, A0041518901, A0041519201

BOSCH: 0 001 109 014, 0 001 109 036, 0 001 109 250, 0 001 109 290, 0 001 110 016, 0 001 110 075, 0 001 110 091, 0 001 110 112, 0 001 218 124, 0 001 218 138, 0 001 218 738

CARGO: 111851

APPLICATION / APLICACIÓN:

MERCEDES-BENZ: C-Class Saloon C36 1994>2000, C200 1993>2000, C220 CDI 1997>2000, C250 D 1993>2000, E-Class Saloon/ Estate/Coupe E280 1993>1995, S-Class Saloon S280 / 300 SE 19931998, Vito Van 108/110/112 2.3 1997>2003, Sprinter 2-T Minibus 208/211/216 CDI 1995>2006, Vario Bus O 812 1996>2010, Vario Dumpertruck 612/812 D 1996>2010

GA20053

FEATURES / CARACTERÍSTICAS: **3,0Kw / 12V**

REPLACES / REEMPLAZA:

BOSCH: 9.000.083.014, 9.000.083.027, 9.000.083.029, 9.000.083.053;

MERCEDES-BENZ: 3 431 517 001

APPLICATION / APLICACIÓN:

Agrale-Deutz: BX4.60, BX-60;

Case: W18, W20, W20B;

CBT: 1065, 1105, 2080, 2105, 8060 4x4;

MB: L1013, L1111, L1113, L1313, L1316, L2013, L2016, L2213, L2215, L2216, L608D, L610, O362; SLC: 6200, 7200, 7700

GA20054

FEATURES / CARACTERÍSTICAS: **3,0Kw / 12V**

REPLACES / REEMPLAZA:

BOSCH: 0.001.358.048, 0.001.359.043, 0.001.359.084, 0.001.362.051, 0.001.367.054, 0.001.367.059, 0.001.367.300, 0.001.367.301, 0.001.367.303, 0.986.011.240, 0.986.013.480, 9.000.083.028, 9.000.083.054, SR923X;

CLAAS: 1053560, 6853810;

FAUN: 1701054;

LESTER: 17106;

MERCEDES-BENZ: 0 011 519 401, 0 021 519 401, 0 031 510 501, 0 031 517 301, 0 031 518 701, 0 041 512 201, 3 431 517 101, A 0 011 519 401, A 0 021 519 401, A 0 031 510 501, A 0 031 517 301, A 0 031 518 701, A 0 041 512 201, A 0 041 515 801;

PIC: 120-514, 20-518, 120-518B, 120-518C, 120-524, 182-162, 980-006

APPLICATION / APLICACIÓN:

MB: 709, 710, 712, 914, L1013, L1111, L1113, L1114, L1116, L1117, L1118, L608D, L708E, LA1113, LA1117, LO809, LO814, LPO1113;

New Holland: tractor; **Toyota:** Bandeirante

GA20056



FEATURES / CARACTERÍSTICAS: **3,0Kw / 12V**

REPLACES / REEMPLAZA:

BOSCH: 9.000.083.036, 9.000.083.056, 9.000.083.082;

MWM: 9 0572 01 0 074;

PIC: 120-6249;

VALMET: 221 561

VOLKSWAGEN: 004053778

APPLICATION / APLICACIÓN:

Agrale: 5000, 6000, 7000, BX;

CASE: 80;

CBT: 8000 Series;

Fiatallis: FB Series;

MWM: Diesel D, SLC 7000 Series, TD Series;

Valmet: 110 ID, 118, 128, 138, 148, 62 ID, 65 ID, 78, 88, 880, 980

GA20064



FEATURES / CARACTERÍSTICAS: **4,0Kw / 24V**

REPLACES / REEMPLAZA:

BOSCH: 0.986.012.940, 9.000.083.064, 9.009.083.064;

CASE: E155737;

FIAT: 75207601;

KÄSSBOHRER: 7 431 027 000;

MERCEDES-BENZ: 0 031 511 301, 3 431 517 201, A 3 431 517 201;

VOLVO: 12709015

APPLICATION / APLICACIÓN:

CASE: W18D, W18E, W20E;

MB: L1214, L1217, L1218, L1418;

El Detalle: OA 101

GA20065



FEATURES / CARACTERÍSTICAS: **4,0Kw / 24V**

REPLACES / REEMPLAZA:

Bosch: 9.000.083.065; **Prestolite:** 35251130; **Delco:** 10479652; **Mercedes-Benz:** 001 151 7301, 001 151 9601, 002 151 0701, 003 151 0401, 003 151 0801, 003 151 1301, 003 151 1801, 003 151 2001, 003 151 7401, 003 151 8601, 003 151 8801, 003 151 8801 80, 004 151 5901, 004 151 5901 80, 004 151 7301, 005 151 8501, 151 010 0318, 344 151 7401, 376 151 0301

APPLICATION / APLICACIÓN:

MMB: Models OF 1115, 1315 with engine OM366, L 1317 and L1517 with engine OM352A, O371UL with engine OM366, OF1721 with Engine OM366LA, OH 1315, 1318, 1621, 1623

GA20128



FEATURES / CARACTERÍSTICAS: **2,2Kw / 12V**

REPLACES / REEMPLAZA:

BOSCH: 9.000.083.054, F.000.AL0.128

APPLICATION / APLICACIÓN:

FAMSA: F1314 C/B, F1317 C/B, F1321 C/B, F1514, F1517, F1521;

Ford-New Holland: 8040, 8055;

MB: 1214, 1714, 1718, 1720, 1721, 1722, 1723, 2418, 709, 710, 712, 912, 914, L1113, L1114, L1116, L1117, L1118, L1214, L1217, L1218, L1313, L1314, L1316, L1317, L1318, L1319, L1414, L1418, L1420, L1513, L1516, L1517, L1518, L1614, L1618, L1620, L1621, L1717, L2013, L2014, L2016, L2213, L2214, L2216, L2217, L2314, L2318, L608D, L708E, LA1113, LA1117, LA1313, LA1513, LA2013, LA2213, LB2218, LB2318, LK2218, LK2318, LO708E, LO809, LO812, LO814, LPO1113, LS1313, LS1518, O362, O364, O365, OF1113, OF1114, OF1313, OF1314, OF812, OH1313, OH1314, OH1316;

Toyota: Bandeirante

GA20205 // NEW //



FEATURES / CARACTERÍSTICAS: **12V | 2.0 kW**

REPLACES / REEMPLAZA:

CITROËN/ PEUGEOT: 9675092580, 5802FC, 5802AS; **FIAT:** 9658144780, 95681447; **FORD:** 6C1T11000AE, 6C1T11000AD, 6C1T11000AC, 6C1T11000AB, 6C1T11000AA; **LAND ROVER:** NAD500270; **BOSCH:** 0 001 105 205, 0 001 109 205, 0 001 109 304, 0 001 109 305, 0 001 109 324, 0 001 109 325, 0 001 109 328, 0 001 109 329, 0 001 109 387, 0 001 109 388, 0 001 109 391, 0 001 109 392, 0 001 115 092, 0 001 115 093; **CARGO:** 113959

APPLICATION / APLICACIÓN:

CITROËN: Relay Mk3 Minibus 2.2 Hdi 100/120/130/150 2006->, Relay Mk3 Van 2.2 Hdi 100/110/120/130/150 2006->, Relay Mk3 Flatbed 2.2 Hdi;

FIAT: Ducato Van 100 Multijet 2.2 2006>2011, Ducato Flatbed 100 Multijet 2.2 2006->;

FORD: Transit Mk7 Minibus 2.2 TDCi 2006>2014, Tourneo Custom Bus 2.2 TDCi 2012->;

LAND ROVER: Defender Station Wagon 2.2 Td4 4x4 2007>2016, Defender 110 2.2/2.4 Td4 2007>2016, Defender 110 Pick-up 2.2/2.4 2007>2016, Defender Platform/Chassis 2.2 Td4 4x4 2011>2016;

PEUGEOT: Boxer Mk3 Minibus 2.2 Hdi 100/110/120/130/150 2006->, Boxer Mk3 Van 2.2 Hdi 100/110/120/130/150 2006->, Boxer Mk3 Flatbed 2.2 Hdi 100/110/120/130/150 2006->

GA21057



FEATURES / CARACTERÍSTICAS: 24V | 11.0kW | 11T 56mm

REPLACES / REEMPLAZA:

Delco: 10461057; Transpo: 4930N

APPLICATION / APLICACIÓN:

Autocar HD Heavy Duty: All Models (By Engine) Caterpillar 3406 1975>1979;

Case Agricultural Tractor: 9150 Cummins 6-1150 Dsl 1986>1993;

Case Crawlers/Excavator: 120C DD 12V-71 1979;

Caterpillar Ag. & Ind. Compactor: 825C/826c Cat. 3406 1978>1985

Caterpillar Ag. & Ind. Engine - Marine: 3406/3408/3412/3508/3512/3516 6cyl 1986>1995;

Caterpillar Ag. & Ind. Excavator: 245 Cat. 3406 1972>1988;

Clark Dozer: 380/380 III Cummins KTA-1150 1981>1986;

Clark Tractor Shovel: 275K/475 III Cummins KTA-1150 1981>1986;

Construction Equipment Co. Tournapul: BPA-11/BPA-5 DD 12V-71 Diesel 1967>1974;

Komatsu Crawler Tractor: D85E-12 Cummins Dsl. 1985>2001

GA21098 // NEW //



FEATURES / CARACTERÍSTICAS: 12V | 2.2kW

REPLACES / REEMPLAZA:

CITROËN/ PEUGEOT: 9646694080, 9662854180; **CARGO:** 114030; **TRANSPO:** 33275N

APPLICATION / APLICACIÓN:

CITROËN: Berlingo Van Mk1 1.6 Hdi 2005>2011, Berlingo MultiSpace Mk2 1.6 Hdi 75 / 90 / 100 / 110 / 115 2008->, Berlingo Van Mk2 1.6 Hdi 75 / 90 / 100 / 110 / 115 2008->, C2 1.6 Hdi 2005->, C3 1.6 16v Hdi 2005->, C4 Saloon/Coupe 1.6 HDi 2006>2011, C5 Mk2 hatch /estate 1.6 HDi 2004->, Dispatch Mk2 1.6 HDi 90 16v 2007->;

PEUGEOT: 206 hatch 1.6 HDi 110 2004->, 207 hatch 1.6 HDi 2006->, 307 hatch 1.6 HDi 2004->, 407 Saloon 1.6 / 2.0 HDi 2004->, 508 1.6 HDi 2010->, 5008 1.6 HDi 2009->, Expert Box 1.6 BlueHDi 95 2016->, Partner Mk2 Van 1.6 HDi 2008->;

DS: DS3 1.6 Diesel 2015>

GA21276



FEATURES / CARACTERÍSTICAS: 12V | 2.5kW | 10T 32mm

REPLACES / REEMPLAZA:

Delco: 1113276; Transpo: 6573N

APPLICATION / APLICACIÓN:

Allis Chalmers 1965>1974, Apache 1999>2007, Bomag 1996>2006, Consolidated Diesel 1991>1992, Cummins Engines 1994>2000, Cummins Marine Engines 1990>1997, Cummins Mercruiser 1989>1996, Dow Warner 1990>2000, Dynapac 1996>2004, Ford 1983>1984, Freightliner 1989>2001, Harlo 1989>1992, Hyster 1999>2006, Ingersoll Rand 1990>1997, Kenworth (1994>2007, Mercruiser 1994>1998, Miller Applications Technology 1998>2004, Prairie 1998>2004, PSI 2001>2007, Shuttlewagon 1996>2002, Sterling Truck 1999>2002, Timberjack 1995>2002, White Industrial 1988>1992, Willmar 1997>2007

GA21367



FEATURES / CARACTERÍSTICAS: 24V | 7.8kW | 11T 56mm

REPLACES / REEMPLAZA:

Delco: 1990367; Transpo: 6370N

APPLICATION / APLICACIÓN:

Allis Chalmers Loader: 945 25000 Allis Dsl. 1985>1986;

Case Crane: 1000 Travelift DD 4-71 1985>1994;

Case Excavator/Marine: 40D DD 4-71 1985>1986;

Case Tractor: 980 DD 4-71 1985>1986;

Caterpillar Ag. & Ind. Compactor: 825C Cat. 3406 1986>1996;

Clark Dozer: 280 Cummins N14 1985-1986;

Fiat-Allis Tractor Scraper: 260B 25000 Allis Dsl. 1985;

Kobelco Excavator: SK400LC-IV 6D22TC Mitsubishi Diesel 1995>1998;

Tanguy Loader: TT14030 Cat. 3304, 7.0L 1985-2002;

Hyundai Excavator: R360-3 Cummins Diesel 1996>2006

GA21433



FEATURES / CARACTERÍSTICAS: 12V | 7.3kW | 12T

REPLACES / REEMPLAZA:

Delco: 8200433; Transpo: 6907N

APPLICATION / APLICACIÓN:

Freightliner Heavy Duty: FL 50 Cummins 1994>2006;

Freightliner Medium/Heavy Truck: Business Class M2 Cummins 2003, FC80 Cummins 8.3L ISC 1998>2008;

Peterbilt Heavy Duty: 320/330/335/340/379 Models Cummins 8.3L ISC 1991>2003;

Sterling Truck Medium/Heavy Truck: Acterra 5500 L6 2001, L7500 L6 8.3L 1999>2008;

Tigercat Harvester: H822/830 QSL Cummins Diesel 2003>2008;

Volvo Medium/Heavy Truck: ACL42 / ACL64 Series Volvo VED 12 1996>2002;

Willmar Sprayer: Eagle 8500 QSC 8.3L Eng. 2003>2008

GA21436



FEATURES / CARACTERÍSTICAS: 24V | 8.3kW | 12T

REPLACES / REEMPLAZA:

Delco: 8200436, 8200519; Transpo: 6857N

APPLICATION / APLICACIÓN:

MERCEDES HEAVY DUTY - EUROPE BUS: O345G OM457.942 2001>2013, O500MA OM457LA 2006>2013, O500RS-RSD OM457LA 2001>2005, O530GN3 OM457.933 HLA, 1999>2004, O530GN3 OM457.934 1999>2004, O530GN3 OM457.935 1999>2004;
MERCEDES HEAVY DUTY EUROPE - MEDIUM/HEAVY TRUCK: 2035/2040/2044/2540/2544/2640/2644 OM457LA 2005>2013

GA21483



FEATURES / CARACTERÍSTICAS: 12V | 7.6kW | 11T

REPLACES / REEMPLAZA:

Delco: 1990483; Transpo: 6356N

APPLICATION / APLICACIÓN:

Agco Gleaner 1992>2003, Buhler Versatile 2002>2007, Case 1986>2007, Caterpillar Ag. & Ind. 1985>2006, Champion 1985>1994, Chevrolet 1986>1989, Clark 1986>1987, Cummins Engines 1983>1993, Ford 1982>1999, Freightliner 1982>2008, GMC 1986>1989, International 1975>2007, John Deere 1981>1996, Kenworth 1984>2003, Mack 1984>2009, New Holland Industrial 1985>2006, Peterbilt 1983>1994, Spray Monster 1994>2000, Steiger 1986>1992, Sterling Truck 1999>2008, Versatile (1979>1993, Volvo 1983>2009, Waukesha (1986>1990, Western Star HD 1984>2008, White Industrial 1982>1995

GA21815



FEATURES / CARACTERÍSTICAS: 24V | 7.5kW | 12T 46mm

REPLACES / REEMPLAZA:

Delco: 10478815; Transpo: 6633N

APPLICATION / APLICACIÓN:

Caterpillar Ag. & Ind. 1993>1996

GA21918



FEATURES / CARACTERÍSTICAS: 24V | 4.5kW | 12T 46mm

REPLACES / REEMPLAZA:

Delco: 1993918; Transpo: 6405N

APPLICATION / APLICACIÓN:

Caterpillar Ag. & Ind. 1993>1996

GA21947



FEATURES / CARACTERÍSTICAS: 12V | 4.5kW | 10T 40mm

REPLACES / REEMPLAZA:

Delco: 1993947; Transpo: 6504N-PT

APPLICATION / APLICACIÓN:

CHEVROLET MEDIUM/HEAVY: B7 L6 Caterpillar 3116 1993>1998
TRUCK: B7 L6 Caterpillar 3126 1998, C50 Caterpillar 3116 1991>2000, C5500 Kodiak Caterpillar 3116 1990>2000, C60 Caterpillar 3116 1991>2002, C60 Kodiak L6 6.6L 403cid Caterpillar 3116 1990>1996, C6500 Kodiak Caterpillar 3116 1990>1996, C70 Caterpillar 3116 1991>2002, C70 Kodiak L6 Caterpillar 3116 1990>1996, C7500 Kodiak Caterpillar 3116 1990>1996, C7500 Kodiak Caterpillar 3116 1999>2002, C80 Caterpillar 3116 1990>2002, T5500 Caterpillar 3116 1997>1998;
CHEVROLET VAN: P30 Caterpillar 3116 1990>1998, P30 Caterpillar 3116 2000;
FORD MEDIUM/HEAVY TRUCK: L6000 Caterpillar 3126 1995>1997, L7000 Caterpillar 3126 1995>1997, L8000 Series Caterpillar 3126 1995>1997, L9000 Series Caterpillar 3126 1995-1997;
GMC MEDIUM/HEAVY TRUCK: B7 L6 Caterpillar 3116 1993>1998;
GMC VAN: P3500 Caterpillar 3116 1990>1999

GA22001



FEATURES / CARACTERÍSTICAS: 12V | 2.2kW | 9T 32mm

REPLACES / REEMPLAZA:

Hitachi: S13-114; Transpo: 31230N; Cargo: 111559

APPLICATION / APLICACIÓN:

Isuzu Europe 1989>1998, Opel Europe 1989>2001, Vauxhall - Europe 1991>2001

GA22002

FEATURES / CARACTERÍSTICAS: 24V | 3.5kW | 9T 35mm

REPLACES / REEMPLAZA:

Hitachi: S24-03C; Transpo: 18284N; Cargo: 110723; AS Poland: S2003

APPLICATION / APLICACIÓN:

Isuzu Engines Industrial: Misc. Industrial Equipment 4BC1 Engine 1979>1986, Misc. Industrial Equipment 4BC2 Engine 1984>1986

GA22829 // NEW //

FEATURES / CARACTERÍSTICAS: 12V | 1.4kW

REPLACES / REEMPLAZA:

OPEL: 6202103, 6202087, 6202043, 6202000, 1202591;

HITACHI: S114-829, S114-829A, s114-829B, S114-829C, S114-829D, S114-869, S114-925, S114-925A, S114-925B, S114-925C;

CARGO: 112320;

TRANSPRO: 31224N, 31224R

APPLICATION / APLICACIÓN:

OPEL: Astra G Hatch/Saloon/Estate/Van 1.7 DTI 16v 2000>2009, Astra H Hatch/Saloon/Estate/Box 1.7 CDTI 2004>2014, Astra J Saloon/GTC/Sports Tourer 1.7 CDTI 2012->, Combo Tour 1.7 DI / DTI 16v 2001->, Corsa C Hatch/Van 1.7 DI / DTI / CDTI 2000>2009, Meriva 1.7 DTI / CDTI 2003>2010, Signum 2.2 DTI 2003>2004, Zafira B MPV/Van 1.7 CDTI 2008>

GA23054 // NEW //

FEATURES / CARACTERÍSTICAS: 12V | 1.2kW

REPLACES / REEMPLAZA:

FIAT: 9609313280; CITROËN/ PEUGEOT: 5802Y3, 5802R4, 5802Q1, 5802P8, 5802N3, 5802E8; CARGO: 110584;

AS-POLAND: S3005; TRANSPRO: 30737N

APPLICATION / APLICACIÓN:

FIAT: Fiorino Van 1.4 2007->;

CITROËN: Ax 10E 1986>1988, Ax 14 1986>1996, Ax 1.4 Gti 1991>1996, Berlingo MultiSpace Mk1 1.1i / 1.4i / 1.6i 1996>2011, BX hatch 11 / 14 1983>1993, C-Elysee 1.6 Vti 115 2012->, C2 / C3 / C4 2003>2011, Nemo Estate 1.4 2009->, Saxo hatch 1.0x / 1.1x / 1.4x / 1.6x 1996>2003, Xsara Hatch/Estate/Coupe/Picasso 1.4/1.6 1997>2010, ZX Hatch/Estate 1.1 / 1.4 1991>1997, C15 Kombi 1.4 1991>1996;

PEUGEOT: 106 Hatch 1.0 / 1.1 / 1.3 / 1.4 / 1.6 1991>1996, 205 Mk1

GA23110 // NEW //

FEATURES / CARACTERÍSTICAS: 12V | 1.4kW

REPLACES / REEMPLAZA:

VALEO: D6RA110, TS14E110; TOYOTA: 28100-YV010; FIAT: 9637813680; CITROËN/ PEUGEOT: 9688268580, 9637813680;

CARGO: 113254; TRANSPRO: 32570N, 32737N; AS-POLAND: S3016

APPLICATION / APLICACIÓN:

TOYOTA: Aygo hatch 1.4 2005>2010, Proace Box Body 1.6 2013>2016;

FIAT: Scudo Mk2 1.6 D Multijet MPV 2011->, Scudo Mk2 Van 1.6 D Multijet 2011->, Scudo Mk2 Flatbed 1.6 D Multijet 2007->;

CITROËN: Berlingo MultiSpace 1.6 2005>2011, Berlingo Van, C1 1.4 2005>2014, C2 1.4 2003->, C3 1.4 / 1.6 2002->, C4 Hatch 1.6 2004>2011, C5 Mk2 Hatch 1.6 2004->, C5 Mk2 Hatch 2.2 2006->, Nemo Estate/Van 1.4 2009->, Xsara Hatch/Estate/Coupe/Picasso 1.4 2003>2005;

PEUGEOT: 107 hatch 1.4 2005->, 206 hatch/saloon 1.4/1.6 2001->, 207 hatch 1.4 / 1.6 2006->, 208 1.4 / 1.6 2012->, 307 hatch/estate 1.4 / 1.6 2001->, 308 hatch 1.6 2007->, 407 1.6 2004->, 1007 1.4 2005->, 2008 1.4 / 1.6 2013->, Bipper Van 1.4 2008->, Expert Box 1.6 2016->, Partner Mk1 1.6 2005>2015

GA23119 // NEW //

FEATURES / CARACTERÍSTICAS: 12V | 1.0kW

REPLACES / REEMPLAZA:

VALEO: TS10E5, TS10E4, d7e6, d7e26, d7e22, d7e19; RENAULT: 8200082782, 8200049826, 7711134530, 7700105119, 7700104674, 6025008446; CARGO: 112218; TRANSPRO: 31250N; AS-POLAND: S3008

APPLICATION / APLICACIÓN:

RENAULT: Clio 1.6 Mk2 hatch 16v 1.4 / 1.6 1998->, Kangoo Mk1 1.6 16v 2001->, Kangoo Mk1 Van 1.6 16v 2001->, Laguna Mk1 hatch/estate 1.6 16v 1997>2001, Laguna Mk2 hatch/estate 1.6 16v 2001->, Megane Mk1 hatch 1.4 / 1.6 1999>2003, Megane Classic Saloon 1.4 / 1.6 16v 1999>2003, Megane Mk1 estate / coupe 1.4 / 1.6 1999>2003, Megane Convertible 1.4 / 1.6 16v 1999>2003, Scenic Mk1 1.6 16v 1998>1999, Megane Mk2 hatch 1.4 / 1.6 16v 2002>2008, Thalia 1.4 16v 2000->, Thalia II 1.6 16v 2008->

GA23132 // NEW //

FEATURES / CARACTERÍSTICAS: 12V | 0.9kW

REPLACES / REEMPLAZA:

VALEO: d6ra132, d6ra162, D6RA163, D6RA249, D6RA293, d6ra32, d6ra62, D6RA93, d7ep12; CHEVROLET: 96952006, 96952005, 96843578; DAEWOO: 96469960; CARGO: 111123

APPLICATION / APLICACIÓN:

OPEL: Agila 1.0 12v/1.2 16v 2000>2007, Ascona C hatch/saloon 1.6i 1986>1988, Astra F saloon/estate/convertible/fan 1.4 / 1.6 1991>1998, Astra G hatch/saloon/estate/coupe/convertible 1.2 / 1.4 / 1.6 16v 1998>2009, Combo 1.2/1.4 1994>2001, Corsa A hatch/Tr Saloon/Van 1.2 / 1.3 / 1.4 / 1.6 1982>1993, Kadett E hatchback/saloon/estate/convertible 1.4 / 1.6 1986>1991, Meriva 1.4 16v 2004>2010, Tigra 1.4 / 1.6 1994>2000, Vectra A hatch/saloon 1.6 1988>1995;

DAEWOO: Espero saloon 1.5 16v 1993>1999, Kalos hatch 1.4 2002->, Lanos hatch/saloon 1.3 / 1.5 / 1.6 16v 1997->, Nexia hatch/saloon 1.5 / 1.6 16v 1995>1997, Nubira hatch/saloon/estate 1.6 16v 1997>2002, Tacuma 1.6 / 1.8 2000->;

CHEVROLET: Aveo hatch/saloon 1.4 2008->, Kalos 1.4 16v 2005->, Lacetti 1.4 / 1.6 / 1.8 2005->, Nubira saloon/estate 1.6 2005>2011, Tacuma 1.6 2005;

FIAT: Stilo Estate 1.6 16v 2005>2007

GA23604 // NEW //
FEATURES / CARACTERÍSTICAS: 12V | 1.4kW

REPLACES / REEMPLAZA:
VALEO: 182604, 184643, 185625, 185994, d7r12; **CITROËN/ PEUGEOT:** 580292, 580236, 5802V6, 5802S3; **HYUNDAI:** 36100-29000; **SUZUKI:** 31100-86CB1; **CARGO:** 114460; **AS-POLAND:** S0084

APPLICATION / APLICACIÓN:
CITROËN: Berlingo MultiSpace 1.8 / 1.9 / 2.0 1996>2005, BX hatch/estate 1.8D 1983>1993, C4 hatch/coupe/picasso 2.0 16v 2004>2011, Dispatch Mk1 Van 1.9 / 2.0 1995>2006, Visa hatch 17D 1984>1991, Xantia Mk1 hatch/estate 1.9/2.1 1994>1998, Xsara hatch/estate/coupe 1.9/2.0 1997>2005, Relay Mk1 minibus 1.9 1994>2002

PEUGEOT: 205 Mk1/Mk2 hatch 1.7 Diesel, 206 SW Estate 2.0 Hdi 2002->, 305 Mk2 saloon/estate 1.9D 1982>1988, 306 hatch/saloon/estate 1.8 / 1.9 / 2.0 1993>2001, 307 hatch/estate 2.0 16v 2000->, Expert Van 1.9D / 2.0 HDI 1996>2006, Partner Mk1 MPV 1.9D / 2.0 HDI 1996>2008

FIAT: Scudo Mk1 Estate/Van 1.9D / 2.0 JTD 1996>2006, Ulysse Mk1 1.9 TD / 2.0 JTD, Ducato Van 1.9 1998>2002

HYUNDAI: Elantra Mk2 Saloon 1995>2000

SUZUKI: Samurai 1.9 1998>2004, Vitara 1.9D 1995>1998

LANCIA: Phedra 2.0 JTD 2002>2010

GA24090
FEATURES / CARACTERÍSTICAS: 24V | 4.5kW | 11T 40mm

REPLACES / REEMPLAZA:
Denso: 28100-77090; **Transpo:** 17286N; **Cargo:** 110507

APPLICATION / APLICACIÓN:
Toyota Lift Truck: 2FD-100 2D Engine 1984>2001, 3FD-50 2D Engine 1980>2001, 3FD-80 2D Engine 1982>2003, FD-100 2D Engine 1979>1984, FD-70 2D Engine 1982>2001

GA24610
FEATURES / CARACTERÍSTICAS: 12V | 2.5kW | 12T 45mm

REPLACES / REEMPLAZA:
Denso: 228000-1610; **Transpo:** 18197N

APPLICATION / APLICACIÓN:

Toyota Land Cruiser 1990>1999

GA24890
FEATURES / CARACTERÍSTICAS: 12V | 2.2kW | 9T 32mm

REPLACES / REEMPLAZA:
Denso: 228000-1890; **Transpo:** 18449N; **Cargo:** 113132

APPLICATION / APLICACIÓN:
Hyster Lift Truck: H-20-32XM/H-40-65XM 1000.4 Perkins Dsl. 1998>2006, H-45XM/H-50XM Isuzu C-240 Dsl 1994>2006, H-60-65XM Isuzu C-240 Dsl 1994>2006

Isuzu Engines Industrial: Misc. Industrial Equipment 4JG2(C240) Engine 1992>2006

GA25471 // NEW //
FEATURES / CARACTERÍSTICAS: 12V | 1.4kW

REPLACES / REEMPLAZA:
MITSUBISHI: M000T21471, M000T87881, M000T88681, M00T87881, M0T21471, M0T87881, M0T88681, M0T87881;

CARGO: 113897

APPLICATION / APLICACIÓN:
RENAULT: Captur 1.5 Diesel 2013>, Clio Mk2 hatch 1.5 Dci 2004->, Fluence 1.5 Dci 2010->, Kadjar 1.5 Dci 110 2015->, Kangoo Mk1 1.5 Dci 2003->, Laguna Mk3 hatch/estate 1.5 Dci 2007->, Latitude 1.5 Dci 2010->, Logan 1.5 Dci 2008>2015, Megane Mk2 hatch/saloon/estate 1.5 Dci 2003>2009, Grand Scenic 1.5 Dci 2004->, Twingo Mk2 hatch 1.5 Dci 2007->;

DACIA: Dokker 1.5 Dci 2012->, Duster 1.5 Dci 2010->, Logan Saloon 1.5 Dci 2007->, Logan Pickup 1.5 Dci 2008->, Sandero hatch 1.5 Dci 2008->;

NISSAN: Cube 1.5 Dci 2010->, Juke 1.5 Dci 2010->, Kubistar 1.5 Dci 2003>2009, Note 1.5 Dci 2006>2012, Pulsar hatchback 1.5 Dci 2014->, TiidaSaloon 1.5 Dci 2007>2012, Evalia Bus 1.5 Dci 2010->;

SUZUKI: Jimny 1.5 DDIs 4x4 2005->



GA25571

FEATURES / CARACTERÍSTICAS: 12V | 2.2kW | 12T 45mm

REPLACES / REEMPLAZA:

Mitsubishi: M2T50571; Cargo: 113964

APPLICATION / APLICACIÓN:

Nissan: Nissan Frontier, Pick up 2.5 Di/2.5 Di 4WD 2002>2005 / 2.5 TD 4WD 1998>2005



GA25771

FEATURES / CARACTERÍSTICAS: 12V | 2.2kW | 9T 35mm

REPLACES / REEMPLAZA:

Mitsubishi: M2T61771; Transpo: 18240N; AS Poland: S5157

APPLICATION / APLICACIÓN:

Mitsubishi Fuso Medium/Heavy Truck: Canter FB 4DR7 1993>1999



GA25871

FEATURES / CARACTERÍSTICAS: 24V | 3.2kW | 9T 35mm

REPLACES / REEMPLAZA:

Mitsubishi: M2T67871; Transpo: 18241N; Cargo: 110576; AS Poland: S5008

APPLICATION / APLICACIÓN:

Mitsubishi Fuso Medium/Heavy Truck: Canter FB 3.3L(201) - 4D30 / 4DR5 Engine 1984>1989 / 4D31



GA29001

FEATURES / CARACTERÍSTICAS: 24V | 4.5kW | 11T 40mm

REPLACES / REEMPLAZA:

Hino: 28100-78090; AS Poland: S9127

APPLICATION / APLICACIÓN:

Hino J05C



GA29436

FEATURES / CARACTERÍSTICAS: 12V | 2.7kW

REPLACES / REEMPLAZA:

Iskra/ Letrika: 11.130.436, 11.130.685, 11.131.139, AZJ3124, AZJ3229, AZJ3385, IS0436, IS0685; Belarus: 24073708000; Jubana: 123708001; Magneton: 9142780; AS-Poland: S9018; Cargo: 112488; Transpo: 18546N

APPLICATION / APLICACIÓN:

BELARUS: 90, 92, 500/505/520/525 1979>1991, 522, 530/532 1994>1996, 560/562 1992>1996, 570, 572, 590, 592, 820, 822, 826, 890, 892, 900, 902, 905, 920, 922, 925, 950, 952, 1005, 1021, 1025, 5111, 5145, 82.1, 82.3, 1021.3, 1025.4, 1025.4-10/91, 1025.4T, 1025XL, 1220.3, 1220.4, 510E, 512E, 550E, 552E, 800M, 80X, 82.3-23/12, 820R, 892.2, 900S, 920.3, 920.3-70, 920.3A, 920.4-10/91, 921.3, 922.3, 925.3, 925.4, 950S, 952.2, 952.2-70, 952.2-70, 952.4-10/91, 952S, 952XL



ELECTRICAL SPARE PART | PIEZA ELÉCTRICA

WINDSCREEN WIPER MOTOR | MOTOR DEL LIMPIAPARABRISAS

BOSCH
GE5065 // NEW //

REPLACES / REEMPLAZA:

BOSCH: 0 390 243 065; **FORD:** 4M51-17508-AB;

MEAT & DORIA: 207067, 27062

APPLICATION / APLICACIÓN:

FORD: Focus Mk 2 Hatch: 1.4/1.6/1.6 Ti/1.6 LPG/1.8 Flexifuel/2.0/2.0 LPG/2.0 CNG/2.5 ST/2.5 RS/2.5 RS 500/1.6 TDCi/1.8 TDCi/2.0 TDCi/ 2004>2012, Focus Mk 2 Saloon: 1.4/1.6/1.6 Ti/1.8/1.8 Flexifuel/2.0/1.6 TDCi/1.8 TDCi/2.0 TDCi/ 2005>2012, Focus Mk 2 Estate: 1.4/1.6/1.6 Ti/1.6 LPG/1.8/1.8 Flexifuel/2.0/2.0 LPG/1.6 TDCi/1.8 TDCi/2.0 TDCi/ 2004>2012, Focus Mk 2 Convertible: 1.6/2.0/2.0 TDCi/ 2006>2010, Focus Ili: Electric/1.0 EcoBoost/1.5 EcoBoost/1.6 Ti/1.6 LPG/1.6 Flexifuel/1.6 EcoBoost/2.0 Ti-GDi/2.0 ST/2.3 RS AWD/1.5 TDCi/1.5 TDCi ECONetic/1.6 TDCi/1.6 TDCi ECONetic/2.0 TDCi/2.0 TDCi ST/ 2010>, Focus Ili Saloon: 1.0 EcoBoost/1.6 Ti/1.6 Flexifuel/1.6 EcoBoost/1.6 TDCi/2.0 TDCi/ 2010>, Focus Ili Turnier: 1.0 EcoBoost/1.6 Ti/1.6 LPG/1.6 Flexifuel/1.6 EcoBoost/2.0 Ti-GDi/2.0 ST/1.6 TDCi/1.6 TDCi ECONetic/2.0 TDCi/ 2010>

BOSCH
GE5515 // NEW //

REPLACES / REEMPLAZA:

BOSCH: F 00S 2A2 515; **KIA:** 98110-1F000;

MEAT & DORIA: 27088

APPLICATION / APLICACIÓN:

KIA: Sportage 2.0 2004>

BOSCH
GE5516 // NEW //

REPLACES / REEMPLAZA:

BOSCH: F 00S 2A2 571; **KIA:** 98110-3W000;

MEAT & DORIA: 27097

APPLICATION / APLICACIÓN:

KIA: Sportage 1.6 2011>, Sportage 2.0 2014>

RENAULT
GE5634 // NEW //

REPLACES / REEMPLAZA:

RENAULT: 2800004410R; **VALEO:** W000052634

APPLICATION / APLICACIÓN:

RENAULT: Logan 2015>, Sandero 2015>

GM
GE5933 // NEW //

REPLACES / REEMPLAZA:

GM: 96893302; **MEAT & DORIA:** 27338

APPLICATION / APLICACIÓN:

GM: Cruze 1.4/1.6/1.7/1.8 2012>2016























ELECTRICAL SPARE PART | PIEZA ELÉCTRICA

LAMP | FOCO

MINIATURE									
0053	CODE	DESCRIPTION	BULB COLOR	PACKAGE	CATEGORY	TENSION	POWERFUL	BASE	ORIGINAL
	GL0053	Miniature Lamp	Incolor	Box with 10 units	T2W	12V	2W	BA9S	Osram: 3796; Philips: 12913
	GL0053A	Miniature Lamp	Incolor	Box with 10 units	T2W	24V	2W	BA9S	Osram: 3797; Philips: 13913
0067	CODE	DESCRIPTION	BULB COLOR	PACKAGE	CATEGORY	TENSION	POWERFUL	BASE	ORIGINAL
	GL0067	Miniature Lamp	Incolor	Box with 10 units	R5W	12V	5W	BAU15S	MB: 072601 012703; Osram: 5007; Philips: 12821
	GL74	Miniature Lamp	Incolor	Blister with 2 lamps	R5W	12V	5W	BAU15S	MB: 072601 012703; Osram: 5007; Philips: 12821
	GL0067A	Miniature Lamp	Incolor	Box with 10 units	R10W	12V	10W	BAU15S	Osram: 5008; Philips: 12814
	GL0067B	Miniature Lamp	Incolor	Box with 10 units	R5W	24V	5W	BAU15S	Osram: 5627; Philips: 13821
	GL0067C	Miniature Lamp	Incolor	Box with 10 units	R10W	24V	10W	BAU15S	Osram: 5637; Philips: 13814
	GL0067D	Miniature Lamp	Amber	Box with 10 units	R10W	12V	10W	BAU15S	Osram: 5009; Philips: 12093NACP
0069	CODE	DESCRIPTION	BULB COLOR	PACKAGE	CATEGORY	TENSION	POWERFUL	BASE	ORIGINAL
	GL0069	Miniature Lamp	Incolor	Box with 10 units	T4W	12V	4W	BA9S	Osram: 3893; Philips: 12929
	GL0069A	Miniature Lamp	Incolor	Box with 10 units	T4W	24V	4W	BA9S	Osram: 3930; Philips: 13929
	GL137 0069	Miniature Lamp	Incolor	Blister box with 2 lamps	T4W	12V	4W	BA9S	Osram: 3893; Philips: 12929
0075	CODE	DESCRIPTION	BULB COLOR	PACKAGE	CATEGORY	TENSION	POWERFUL	BASE	ORIGINAL
	GL0075	Miniature Lamp	Incolor	Box with 10 units	T2W	12V	2W	-	Osram: 3761
	GL0075A	Miniature Lamp	Incolor	Box with 10 units	T2W	24V	2W	-	-
921	CODE	DESCRIPTION	BULB COLOR	PACKAGE	CATEGORY	TENSION	POWERFUL	BASE	ORIGINAL
	GL921	Miniature Lamp	Incolor	Box with 10 units	W16W	12V	16W	W2.1x9,5d	Osram: 921; Philips: 12067
	GL921A	Miniature Lamp	Amber	Box with 10 units	W16W	12V	16W	W2.1x9,5d	Osram: 921NA; Philips: 12067NA
922	CODE	DESCRIPTION	BULB COLOR	PACKAGE	CATEGORY	TENSION	POWERFUL	BASE	ORIGINAL
	GL922	Miniature Lamp	Incolor	Box with 10 units	-	12V	15W	-	-

MINIATURE

922	CODE	DESCRIPTION	BULB COLOR	PACKAGE	CATEGORY	TENSION	POWERFUL	BASE	ORIGINAL
	GL922A	Miniature Lamp	Amber	Box with 10 units	-	12V	15W	-	-
1034	CODE	DESCRIPTION	BULB COLOR	PACKAGE	CATEGORY	TENSION	POWERFUL	BASE	ORIGINAL
	GL1034	Miniature Lamp	Incolor	Box with 10 units	P21/5W	12V	21/5W	BAY15D	MB: 072601 012210; Osram: 7528; Philips: 12499
	GL70	Miniature Lamp	Incolor	Blister with 2 lamps	P21/5W	12V	21/5W	BAY15D	Osram: 7528; Philips: 12499
	GL1034B	Miniature Lamp	Incolor	Box with 10 units	P21/5W	24V	21/5W	BAY15D	Osram: 7537; Philips: 13499
	GL1034A	Miniature Lamp	Amber	Box with 10 units	P21/5W	12V	21/5W	BAY15D	Philips: 12496NA-CI
1056	CODE	DESCRIPTION	BULB COLOR	PACKAGE	CATEGORY	TENSION	POWERFUL	BASE	ORIGINAL
	GL1056A	Miniature Lamp	Amber	Box with 10 units	PY21W	12V	21W	BAU15S	MB: 400809000005; Osram: 7507; Philips: 12496
	GL1056B	Miniature Lamp	Amber	Box with 10 units	PY21W	24V	21W	BAU15S	Osram: 7510; Philips: 13496
	GL135 1056A	Miniature Lamp	Amber	Blister box with 2 lamps	PY21W	12V	21W	BAU15S	MB: 400809000005; Osram: 7507; Philips: 12496
	GL1056D	Miniature Lamp	Amber	Blister with 2 lamps	PY21W	12V	21W	BAU15S	Osram: 7507LDA- 02B / 7507LDA
	GL1056DC	Miniature Lamp	Amber	Blister with 2 lamps	PY21W	12V	21W	BAU15S	Osram: 7507DC-02B
	GL2550	Miniature Lamp	Incolor	Box with 10 units	PY21W	12V	21W	BAU15S	-
1141	CODE	DESCRIPTION	BULB COLOR	PACKAGE	CATEGORY	TENSION	POWERFUL	BASE	ORIGINAL
	GL1141	Miniature Lamp	Incolor	Box with 10 units	P21W	12V	21W	BA15S	MB: 000000008156; Osram: 7506; Philips: 12498
	GL72	Miniature Lamp	Incolor	Blister with 2 lamps	P21W	12V	21W	BA15S	MB: 000000008156; Osram: 7506; Philips: 12498
	GL1141B	Miniature Lamp	Incolor	Box with 10 units	P21W	24V	21W	BA15S	Osram: 7511; Philips: 13498
	GL1141A	Miniature Lamp	Amber	Box with 10 units	PY21W	12V	21W	BA15S	Philips: 12496
	GL1141C	Miniature Lamp	Amber	Box with 10 units	PY21W	24V	21W	BA15S	-

MINIATURE									
1176	CODE	DESCRIPTION	BULB COLOR	PACKAGE	CATEGORY	TENSION	POWERFUL	BASE	ORIGINAL
	GL1176	Miniature Lamp	Incolor	Box with 10 units	P21/5W	12V	21/5W	BA15D	Osram: 7240; Philips: 12502
	GL1176A	Miniature Lamp	Incolor	Box with 10 units	P21/5W	24V	21/5W	BA15D	Osram: 7242; Philips: 13405
12403	CODE	DESCRIPTION	BULB COLOR	PACKAGE	CATEGORY	TENSION	POWERFUL	BASE	ORIGINAL
	GL12403	Miniature Lamp	Incolor	Box with 10 units	P2215W	12V	15W	BA15s	Philips: 12403CP
12495	CODE	DESCRIPTION	BULB COLOR	PACKAGE	CATEGORY	TENSION	POWERFUL	BASE	ORIGINAL
	GL12495	Miniature Lamp	Red	Box with 10 units	PR21/5W	12V	21/5W	BAW15d	Philips: 12495CP
13401	CODE	DESCRIPTION	BULB COLOR	PACKAGE	CATEGORY	TENSION	POWERFUL	BASE	ORIGINAL
	GL13401	Miniature Lamp	Incolor	Box with 10 units	P2215W	24V	15W	BA15s	Philips: 13401CP; Osram: 7529
2560	CODE	DESCRIPTION	BULB COLOR	PACKAGE	CATEGORY	TENSION	POWERFUL	BASE	ORIGINAL
	GL2560	Miniature Lamp	Incolor	Box with 10 units	P21/4W	12V	21/4W	BAZ15D	Osram: 7225; Philips: 12594
2721	CODE	DESCRIPTION	BULB COLOR	PACKAGE	CATEGORY	TENSION	POWERFUL	BASE	ORIGINAL
	GL2721	Miniature Lamp	Incolor	Box with 10 units	W1.2W	12V	1.2W	W2x4,6d	Osram: 2721; Philips: 12516
	GL2721B	Miniature Lamp	Incolor	Box with 10 units	W1.2W	24V	1.2W	W2x4,6d	Osram: 2741; Philips: 13516
	GL2721A	Miniature Lamp	Blue	Blister with 2 lamps	W1.2W	12V	1.2W	W2x4,6d	-
2722	CODE	DESCRIPTION	BULB COLOR	PACKAGE	CATEGORY	TENSION	POWERFUL	BASE	ORIGINAL
	GL2722	Miniature Lamp	Incolor	Box with 10 units	W2W	12V	2W	W2x4.6d	Osram: 2722
2723	CODE	DESCRIPTION	BULB COLOR	PACKAGE	CATEGORY	TENSION	POWERFUL	BASE	ORIGINAL
	GL2723	Miniature Lamp	Incolor	Box with 10 units	W2.3W	12V	2.3W	W2x4.6d	Osram: 2723 ; Philips: 12061
2820	CODE	DESCRIPTION	BULB COLOR	PACKAGE	CATEGORY	TENSION	POWERFUL	BASE	ORIGINAL
	GL2820	Miniature Lamp	Incolor	Box with 10 units	W2.2W	12V	2.2W	W2.1x9,5d	Osram: 2820

MINIATURE

2821 / 2841	CODE	DESCRIPTION	BULB COLOR	PACKAGE	CATEGORY	TENSION	POWERFUL	BASE	ORIGINAL
	GL2821	Miniature Lamp	Incolor	Box with 10 units	W3W	12V	3W	W2.1x9,5d	Osram: 2821; Philips: 12256
	GL2841	Miniature Lamp	Incolor	Box with 10 units	W3W	24V	3W	W2.1x9,5d	Osram: 2841

2821 / 2841	CODE	DESCRIPTION	BULB COLOR	PACKAGE	CATEGORY	TENSION	POWERFUL	BASE	ORIGINAL
	GL2821A	Miniature Lamp	Blue	Box with 10 units	W3W	12V	3W	W2.1x9,5d	-

2825	CODE	DESCRIPTION	BULB COLOR	PACKAGE	CATEGORY	TENSION	POWERFUL	BASE	ORIGINAL
	GL2825	Miniature Lamp	Incolor	Box with 10 units	W5W	12V	5W	W2.1x9,5d	MB: 000000000853; Osram: 2825; Philips: 12961
	GL2825B	Miniature Lamp	Incolor	Box with 10 units	W5W	24V	5W	W2.1x9,5d	Osram: 2845; Philips: 13961
	GL136 2825	Miniature Lamp	Incolor	Blister box with 2 lamps	W5W	12V	5W	W2.1x9,5d	MB: 000000000853; Osram: 2825; Philips: 12961

	GL2825A	Miniature Lamp	Blue	Box with 10 units	W5W	12V	5W	W2.1x9,5d	-
---	---------	----------------	------	-------------------	-----	-----	----	-----------	---

2827	CODE	DESCRIPTION	BULB COLOR	PACKAGE	CATEGORY	TENSION	POWERFUL	BASE	ORIGINAL
	GL2827	Miniature Lamp	Amber	Box with 10 units	WY5W	12V	5W	W2.1x9,5d	Osram: 2827; Philips: 12396

2840	CODE	DESCRIPTION	BULB COLOR	PACKAGE	CATEGORY	TENSION	POWERFUL	BASE	ORIGINAL
	GL2840	Miniature Lamp	Incolor	Box with 10 units	W2.5W	24V	2.5W	W2.1x9,5d	Osram: 2840











3156	CODE	DESCRIPTION	BULB COLOR	PACKAGE	CATEGORY	TENSION	POWERFUL	BASE	ORIGINAL
	GL3156	Miniature Lamp	Incolor	Box with 10 units	P27W	12V	27W	W2.5x16d	Philips: 3156

	GL3156A	Miniature Lamp	Amber	Box with 10 units	P27W	12V	27W	W2.5x16d	Philips: 3156
--	---------	----------------	-------	-------------------	------	-----	-----	----------	---------------











3157	CODE	DESCRIPTION	BULB COLOR	PACKAGE	CATEGORY	TENSION	POWERFUL	BASE	ORIGINAL
	GL3157	Miniature Lamp	Incolor	Box with 10 units	P27/7W	12V	27/7W	W2.5x16q	Philips: 3157

	GL3157A	Miniature Lamp	Amber	Box with 10 units	P27/7W	12V	27/7W	W2.5x16q	GE: GE3157NA Osram: 3157; Philips: 3157
--	---------	----------------	-------	-------------------	--------	-----	-------	----------	---

6410	CODE	DESCRIPTION	BULB COLOR	PACKAGE	CATEGORY	TENSION	POWERFUL	BASE	ORIGINAL
	GL6410	Miniature Lamp	Incolor	Box with 10 units	C10W	12V	10W	SV8.5-8	Philips: 12854-CI

MINIATURE									
6411	CODE	DESCRIPTION	BULB COLOR	PACKAGE	CATEGORY	TENSION	POWERFUL	BASE	ORIGINAL
	GL6411	Miniature Lamp	Incolor	Box with 10 units	C10W	12V	10W	SV8.5-8	Osram: 6411; Philips: 12866-CI
	GL6411A	Miniature Lamp	Incolor	Box with 10 units	C10W	24V	10W	SV8.5-8	Philips: 13866
6418	CODE	DESCRIPTION	BULB COLOR	PACKAGE	CATEGORY	TENSION	POWERFUL	BASE	ORIGINAL
	GL6418	Miniature Lamp	Incolor	Box with 10 units	C5W	12V	5W	SV8.5-8	Osram: 6418; Philips: 12844
	GL6418A	Miniature Lamp	Incolor	Box with 10 units	C5W	24V	5W	SV8.5-8	Osram: 6423; Philips: 13844
6428	CODE	DESCRIPTION	BULB COLOR	PACKAGE	CATEGORY	TENSION	POWERFUL	BASE	ORIGINAL
	GL6428 8x28	Miniature Lamp	Incolor	Box with 10 units	-	12V	3W	SV7-8	Osram: 6428
6461	CODE	DESCRIPTION	BULB COLOR	PACKAGE	CATEGORY	TENSION	POWERFUL	BASE	ORIGINAL
	GL6461 11x36	Miniature Lamp	Incolor	Box with 10 units	-	12V	10W	SV8.5-8	Osram: 6461; Philips: 12854
7504	CODE	DESCRIPTION	BULB COLOR	PACKAGE	CATEGORY	TENSION	POWERFUL	BASE	ORIGINAL
	GL7504	Miniature Lamp	Amber	Box with 10 units	WY21W	12V	21W	WX3x16d	Osram: 7504
7505 / 7515	CODE	DESCRIPTION	BULB COLOR	PACKAGE	CATEGORY	TENSION	POWERFUL	BASE	ORIGINAL
	GL7505	Miniature Lamp	Incolor	Box with 10 units	W21W	12V	21W	W3x16d	Osram: 7505; Philips: 12065
	GL7515	Miniature Lamp	Incolor	Box with 10 units	W21/5W	12V	21/5W	W3x16q	Osram: 7515; Philips: 12066
	GL7515A	Miniature Lamp	Amber	Box with 10 units	W21/5W	12V	21/5W	W3x16q	Osram: 7515; Philips: 12066
2351MF6	CODE	DESCRIPTION	BULB COLOR	PACKAGE	CATEGORY	TENSION	POWERFUL	BASE	ORIGINAL
	GL2351 MF6	Miniature Lamp	Incolor	Box with 10 units	-	12V	1.2W	Bx8.4d	Osram: 2351MF6
2452MFX6	CODE	DESCRIPTION	BULB COLOR	PACKAGE	CATEGORY	TENSION	POWERFUL	BASE	ORIGINAL
	GL2452 MFX6	Miniature Lamp	Incolor	Box with 10 units	-	12V	1.5W	Bx8.4d	Osram: 2452MFX6
2473MFX6	CODE	DESCRIPTION	BULB COLOR	PACKAGE	CATEGORY	TENSION	POWERFUL	BASE	ORIGINAL
	GL2473 MFX6	Miniature Lamp	Incolor	Box with 10 units	-	12V	1.1W	Bx8.4d	Osram: 2473MFX6

MINIATURE

2721	CODE	DESCRIPTION	BULB COLOR	PACKAGE	CATEGORY	TENSION	POWERFUL	BASE	ORIGINAL
	GL2721MF	Miniature Lamp	Incolor	Box with 10 units	-	12V	1.2W	B8.5d	Osram: 2721MF
2721	CODE	DESCRIPTION	BULB COLOR	PACKAGE	CATEGORY	TENSION	POWERFUL	BASE	ORIGINAL
	GL2721MF8	Miniature Lamp	Incolor	Box with 10 units	-	12V	1.2W	B8.3d	Osram: 2721MF8
	GL2721MFX	Miniature Lamp	Incolor	Box with 10 units	-	12V	1.2W	B8.5d	Osram: 2721MFX
2722	CODE	DESCRIPTION	BULB COLOR	PACKAGE	CATEGORY	TENSION	POWERFUL	BASE	ORIGINAL
	GL2722MF	Miniature Lamp	Incolor	Box with 10 units	-	12V	2W	B8.5d	Osram: 2722MF
	GL2722MFX	Miniature Lamp	Incolor	Box with 10 units	-	12V	2W	B8.5d	Osram: 2722MFX
2723	CODE	DESCRIPTION	BULB COLOR	PACKAGE	CATEGORY	TENSION	POWERFUL	BASE	ORIGINAL
	GL2723MFX6	Miniature Lamp	Incolor	Box with 10 units	-	12V	2.3W	B8.4d	Osram: 2723MFX6
2741	CODE	DESCRIPTION	BULB COLOR	PACKAGE	CATEGORY	TENSION	POWERFUL	BASE	ORIGINAL
	GL2741MF	Miniature Lamp	Incolor	Box with 10 units	-	24V	1.2W	B8.5d	Osram: 2741MF; Philips: 13598
	GL2741MF8	Miniature Lamp	Incolor	Box with 10 units	-	24V	1.2W	B8.3d	Osram: 2741MF8; Philips: 13597
	GL2741MFX	Miniature Lamp	Incolor	Box with 10 units	-	24V	1.2W	Bx8.5d	Osram: 2741MFX
2752	CODE	DESCRIPTION	BULB COLOR	PACKAGE	CATEGORY	TENSION	POWERFUL	BASE	ORIGINAL
	GL2752MF	Miniature Lamp	Incolor	Box with 10 units	-	12V	1.5W	B8.5d	Osram: 2752MF
64124	CODE	DESCRIPTION	BULB COLOR	PACKAGE	CATEGORY	TENSION	POWERFUL	BASE	ORIGINAL
	GL64124MF	Miniature Lamp	Incolor	Box with 10 units	-	12V	5W	B10d	Osram: 64124MF

MINIATURE

PWY24W	CODE	DESCRIPTION	BULB COLOR	PACKAGE	CATEGORY	TENSION	POWERFUL	BASE	ORIGINAL
	GL12174A	Miniature Lamp	Amber	Individual	PWY24W	12V	24W	WP3.3x14.5/4	Philips: 12174NAHTRC1

PSY24W	CODE	DESCRIPTION	BULB COLOR	PACKAGE	CATEGORY	TENSION	POWERFUL	BASE	ORIGINAL
	GL12180	Miniature Lamp	Amber	Individual	PSY24W	12V	24W	PG20-4	Philips: 12180SV+C1

	GL12188	Miniature Lamp	Amber	Individual	PSY24W	12V	24W	PG20-4	Philips: 12188NAC1
--	---------	----------------	-------	------------	--------	-----	-----	--------	--------------------

COMMON LIGHT BULB

R2	CODE	DESCRIPTION	BULB COLOR	PACKAGE	CATEGORY	TENSION	POWERFUL	BASE	ORIGINAL
	GL4540	Miniature Lamp	Incolor	Individual	R2	12V	45/40W	P45t	Philips: 12620-CI
	GL7570	Miniature Lamp	Incolor	Individual	R2	12V	75/70W	P45t	-
	GL5550	Halogen Lamp	Incolor	Individual	R2	24V	55/50W	P45t	Philips: 13620-C1; Osram: 7952

	GL7550B	Miniature Lamp	Incolor	Individual	R2	24V	75/70W	P45t	-
--	---------	----------------	---------	------------	----	-----	--------	------	---

HALOGEN

0885	CODE	DESCRIPTION	BULB COLOR	PACKAGE	CATEGORY	TENSION	POWERFUL	BASE	ORIGINAL
	GL0885	Halogen Lamp	Incolor	Individual	H50W/1	12V	50W	-	-

0886	CODE	DESCRIPTION	BULB COLOR	PACKAGE	CATEGORY	TENSION	POWERFUL	BASE	ORIGINAL
	GL0886	Halogen Lamp	Incolor	Individual	H50W/2	12V	50W	-	-

H1	CODE	DESCRIPTION	BULB COLOR	PACKAGE	CATEGORY	TENSION	POWERFUL	BASE	ORIGINAL
	GL01	Halogen Lamp	Incolor	Individual	H1	12V	55W	P14.5S	Osram: 64150; Philips: 12258
	GL03	Halogen Lamp	Incolor	Individual	H1	12V	100W	P14.5S	
	GL44	Halogen Lamp	Incolor	Individual	H1	24V	70W	P14.5S	Osram: 64155; Philips: 13258
	GL106	Halogen Lamp	Incolor	Individual	H1	24V	100W	P14.5S	Narva: 48750
	GL126	Halogen Lamp	Incolor	Blister with 1 lamp	H1	12V	55W	P14.5S	Osram: 64150; Philips: 12258
	GL132	Halogen Lamp	Incolor	Blister box with 2 lamps	H1	12V	55W	P14.5S	Osram: 64150; Philips: 12258
	GL142	Halogen Lamp	Incolor	Acrylic box with 2 lamps	H1	12V	55W	P14.5S	Osram: 64150; Philips: 12258

HALOGEN

H1	CODE	DESCRIPTION	BULB COLOR	PACKAGE	CATEGORY	TENSION	POWERFUL	BASE	ORIGINAL
	GL02	Halogen Lamp Max Light	Blue	Individual	H1	12V	55W	P14.5S	Osram: 64150-CBI; Philips: 12258BV
	GL04	Halogen Lamp Max Light	Blue	Individual	H1	12V	100W	P14.5S	-
	GL55	Halogen Lamp Max Light	Blue	Blister with 2 lamps	H1	12V	55W	P14.5S	Osram: 64150-CBI (2x); Philips: 12258BV (2x)
	GL56	Halogen Lamp Max Light	Blue	Blister with 2 lamps	H1	12V	100W	P14.5S	-
	GL91	Halogen Lamp Max Light	Blue	Blister box with 2 lamps	H1	24V	70W	P14.5S	Alper: 17120
	GL107	Halogen Lamp Max Light	Blue	Individual	H1	24V	100W	P14.5S	-
	GL108	Halogen Lamp Max Light	Blue	Blister with 2 lamps	H1	24V	100W	P14.5S	-







H3	CODE	DESCRIPTION	BULB COLOR	PACKAGE	CATEGORY	TENSION	POWERFUL	BASE	ORIGINAL
	GL05	Halogen Lamp	Incolor	Individual	H3	12V	55W	PK22S	Osram: 64151; Philips: 12336
	GL07	Halogen Lamp	Incolor	Individual	H3	12V	100W	PK22S	-
	GL45	Halogen Lamp	Incolor	Individual	H3	24V	70W	PK22S	Osram: 64156; Philips: 13336
	GL103	Halogen Lamp	Incolor	Individual	H3	24V	100W	PK22S	Philips: 13628; Narva: 48751
	GL127	Halogen Lamp	Incolor	Blister with 1 lamp	H3	12V	55W	PK22S	Osram: 64151; Philips: 12336
	GL133	Halogen Lamp	Incolor	Blister with 2 lamps	H3	12V	55W	PK22S	Osram: 64151; Philips: 12336
	GL164	Halogen Lamp	Incolor	Blister box with 2 lamps	H3	12V	55W	PK22S	Osram: 64151; Philips: 12336











H3	CODE	DESCRIPTION	BULB COLOR	PACKAGE	CATEGORY	TENSION	POWERFUL	BASE	ORIGINAL
	GL06	Halogen Lamp Max Light	Blue	Individual	H3	12V	55W	PK22S	Osram: 64151-CBI; Philips: 12336BV
	GL08	Halogen Lamp Max Light	Blue	Individual	H3	12V	100W	PK22S	-
	GL57	Halogen Lamp Max Light	Blue	Blister with 2 lamps	H3	12V	55W	PK22S	Osram: 64151-CBI (2x); Philips: 12336BV (2x)
	GL58	Halogen Lamp Max Light	Blue	Blister with 2 lamps	H3	12V	100W	PK22S	-
	GL92	Halogen Lamp Max Light	Blue	Blister box with 2 lamps	H3	24V	70W	PK22S	Alper: 17121; Philips: 13336MDBVS2; Osram: 64156TSP-HCB
	GL104	Halogen Lamp Max Light	Blue	Individual	H3	24V	100W	PK22S	-
	GL105	Halogen Lamp Max Light	Blue	Blister with 2 lamps	H3	24V	100W	PK22S	-

H3C	CODE	DESCRIPTION	BULB COLOR	PACKAGE	CATEGORY	TENSION	POWERFUL	BASE	ORIGINAL
	GL90	Halogen Lamp	Incolor	Individual	H3C	12V	100W	PK22d	-
	GL138	Halogen Lamp	Incolor	Individual	H3C	24V	100W	PK22d	-



HALOGEN										
H3C	CODE	DESCRIPTION	BULB COLOR	PACKAGE	CATEGORY	TENSION	POWERFUL	BASE	ORIGINAL	
	GL139	Halogen Lamp	Blue	Acrylic Box with 2 lamps	H3C	12V	100W	PK22d	-	
	GL140	Halogen Lamp	Blue	Acrylic Box with 2 lamps	H3C	24V	100W	PK22d	-	
H4	CODE	DESCRIPTION	BULB COLOR	PACKAGE	CATEGORY	TENSION	POWERFUL	BASE	ORIGINAL	
	GL09	Halogen Lamp	Incolor	Individual	H4	12V	35/35W	P43T-38	Philips: 12458	
	GL11	Halogen Lamp	Incolor	Individual	H4	12V	60/55W	P43T-38	Osram: 64193; Philips: 12342	
	GL13	Halogen Lamp	Incolor	Individual	H4	12V	100/90W	P43T-38	Philips: 12569 RA	
	GL68	Halogen Lamp	Incolor	Blister with 2 lamps	H4	12V	60/55W	P43T-38	Osram: 64193 (2x); Philips: 12342 (2x)	
	GL46	Halogen Lamp	Incolor	Individual	H4	24V	75/70W	P43T-38	Osram: 64196; Philips: 13342	
	GL100	Halogen Lamp	Incolor	Individual	H4	24V	90/100W	P43T-38	Philips: 24569 Narva: 48991	
	GL128	Halogen Lamp	Incolor	Blister with 1 lamp	H4	12V	60/55W	P43T-38	Osram: 64193; Philips: 12342	
	GL143	Halogen Lamp	Incolor	Acrylic Box with 2 lamps	H4	12V	60/55W	P43T-38	Osram: 64193ULT-HCB	
H4	CODE	DESCRIPTION	BULB COLOR	PACKAGE	CATEGORY	TENSION	POWERFUL	BASE	ORIGINAL	
	GL10	Halogen Lamp Max Light	Blue	Individual	H4	12V	35/35W	P43T-38	-	
	GL12	Halogen Lamp Max Light	Blue	Individual	H4	12V	60/55W	P43T-38	Osram: 64193-CBI; Philips: 12342BV	
	GL14	Halogen Lamp Max Light	Blue	Individual	H4	12V	100/90W	P43T-38	-	
	GL59	Halogen Lamp Max Light	Blue	Blister with 2 lamps	H4	12V	60/55W	P43T-38	Osram: 64193-CBI (2x); Philips: 12342BV (2x)	
	GL60	Halogen Lamp Max Light	Blue	Blister with 2 lamps	H4	12V	100/90W	P43T-38	-	
	GL93	Halogen Lamp Max Light	Blue	Blister box with 2 lamps	H4	24V	75/70W	P43T-38	Alper: 17122; Philips: 13342MDBVS2; OSRAM: 64196TSP-HCB	
	GL101	Halogen Lamp Max Light	Blue	Individual	H4	24V	100/90W	P43T-38	-	
	GL102	Halogen Lamp Max Light	Blue	Blister with 2 lamps	H4	24V	100/90W	P43T-38	-	
H4A	CODE	DESCRIPTION	BULB COLOR	PACKAGE	CATEGORY	TENSION	POWERFUL	BASE	ORIGINAL	
	GL154	Halogen Lamp	Incolor	Individual	H4A	12V	60/55W	P36T	-	
H4B	CODE	DESCRIPTION	BULB COLOR	PACKAGE	CATEGORY	TENSION	POWERFUL	BASE	ORIGINAL	
	GL141	Halogen Lamp	Incolor	Individual	H4B	12V	60/55W	-	Philips: 12342C1	
H5	CODE	DESCRIPTION	BULB COLOR	PACKAGE	CATEGORY	TENSION	POWERFUL	BASE	ORIGINAL	
	GL15	Halogen Lamp	Incolor	Individual	H5	12V	60/55W	P45T	Philips: 12596	
	GL17	Halogen Lamp	Incolor	Individual	H5	12V	100/90W	P45T	-	
	GL47	Halogen Lamp	Incolor	Individual	H5	24V	75/70W	P45T	-	



HALOGEN

H5	CODE	DESCRIPTION	BULB COLOR	PACKAGE	CATEGORY	TENSION	POWERFUL	BASE	ORIGINAL
	GL16	Halogen Lamp Max Light	Blue	Individual	H5	12V	60/55W	P45T	-
	GL18	Halogen Lamp Max Light	Blue	Individual	H5	12V	100/90W	P45T	-
H6W	CODE	DESCRIPTION	BULB COLOR	PACKAGE	CATEGORY	TENSION	POWERFUL	BASE	ORIGINAL
	GL77	Halogen Lamp	Incolor	Box with 10 units	H6W	12V	6W	BAX9s	Osram: 64132
H7	CODE	DESCRIPTION	BULB COLOR	PACKAGE	CATEGORY	TENSION	POWERFUL	BASE	ORIGINAL
	GL19	Halogen Lamp	Incolor	Individual	H7	12V	55W	PX26d	MB: 400809000007; Osram: 64210; Philips: 12972
	GL21	Halogen Lamp	Incolor	Individual	H7	12V	100W	PX26d	-
	GL48	Halogen Lamp	Incolor	Individual	H7	24V	70W	PX26d	Osram: 64215; Philips: 13972
	GL109	Halogen Lamp	Incolor	Individual	H7	24V	100W	PX26d	-
	GL129	Halogen Lamp	Incolor	Blister with 1 lamp	H7	12V	55W	PX26d	MB: 400809000007; Osram: 64210; Philips: 12972
H7	CODE	DESCRIPTION	BULB COLOR	PACKAGE	CATEGORY	TENSION	POWERFUL	BASE	ORIGINAL
	GL134	Halogen Lamp	Incolor	Blister box with 2 lamps	H7	12V	55W	PX26d	MB: 400809000007; Osram: 64210; Philips: 12972
	GL144	Halogen Lamp	Incolor	Acrylic box with 2 lamps	H7	12V	55W	PX26d	MB: 400809000007; Osram: 64210; Philips: 12972
	GL20	Halogen Lamp Max Light	Blue	Individual	H7	12V	55W	PX26d	Osram: 64210-CBI; Philips: 12972BV
	GL22	Halogen Lamp Max Light	Blue	Individual	H7	12V	100W	PX26d	-
	GL61	Halogen Lamp Max Light	Blue	Blister with 2 lamps	H7	12V	55W	PX26d	Osram: 64210-CBI (2x); Philips: 12972BV (2x)
	GL62	Halogen Lamp Max Light	Blue	Blister with 2 lamps	H7	12V	100W	PX26d	-
	GL94	Halogen Lamp Max Light	Blue	Blister box with 2 lamps	H7	24V	70W	PX26d	Alper: 17123; Philips: 13972MDBVS2; Osram: 64215TSP-HCB
	GL110	Halogen Lamp Max Light	Blue	Individual	H7	24V	100W	PX26d	-
	GL111	Halogen Lamp Max Light	Blue	Blister with 2 lamps	H7	24V	100W	PX26d	-
H8	CODE	DESCRIPTION	BULB COLOR	PACKAGE	CATEGORY	TENSION	POWERFUL	BASE	ORIGINAL
	GL78	Halogen Lamp	Incolor	Individual	H8	12V	35W	PGJ19-1	Osram: 64212; Philips: 12360-CI
	GL79	Halogen Lamp Max Light	Blue	Blister with 2 lamps	H8	12V	35W	PGJ19-1	-

HALOGEN									
H9	CODE	DESCRIPTION	BULB COLOR	PACKAGE	CATEGORY	TENSION	POWERFUL	BASE	ORIGINAL
	GL80	Halogen Lamp	Incolor	Individual	H9	12V	65W	PGJ19-5	Osram: 64213; Philips: 12361-CI
	GL81	Halogen Lamp Max Light	Blue	Blister with 2 lamps	H9	12V	65W	PGJ19-5	-
H10	CODE	DESCRIPTION	BULB COLOR	PACKAGE	CATEGORY	TENSION	POWERFUL	BASE	ORIGINAL
	GL86	Halogen Lamp	Incolor	Individual	H10	12V	42W	PGJ19-5	Philips: 9145; Osram: 9145; Hella: 9145
	GL153	Halogen Lamp	Incolor	Blister with 1 lamp	H10	12V	42W	PGJ19-5	Philips: 9145; Osram: 9145
	GL87	Halogen Lamp Max Light	Blue	Blister with 2 lamps	H10	12V	42W	PGJ19-5	-
H11	CODE	DESCRIPTION	BULB COLOR	PACKAGE	CATEGORY	TENSION	POWERFUL	BASE	ORIGINAL
	GL23	Halogen Lamp	Incolor	Individual	H11	12V	55W	PGJ19-2	Osram: 64211; Philips: 12362
	GL130	Halogen Lamp	Incolor	Individual	H11	24V	70W	PGJ19-2	-
	GL25	Halogen Lamp	Incolor	Individual	H11	12V	100W	PGJ19-2	-
	GL24	Halogen Lamp Max Light	Blue	Individual	H11	12V	55W	PGJ19-2	Osram: 64211-CBI
	GL26	Halogen Lamp Max Light	Blue	Individual	H11	12V	100W	PGJ19-2	-
	GL95	Halogen Lamp Max Light	Blue	Blister box with 2 lamps	H11	12V	55W	PGJ19-2	Osram: 64211-CBI; Philips: 12362WHVB1
	GL131	Halogen Lamp Max Light	Blue	Blister with 2 lamps	H11	24V	70W	PGJ19-2	Osram: 64216 Max Light
H11B	CODE	DESCRIPTION	BULB COLOR	PACKAGE	CATEGORY	TENSION	POWERFUL	BASE	ORIGINAL
	GL112	Halogen Lamp	Incolor	Individual	H11B	12V	55W	PGJY19-2	Osram: 64241
	GL113	Halogen Lamp Max Light	Blue	Blister with 2 lamps	H11B	12V	55W	PGJY19-2	-
H13	CODE	DESCRIPTION	BULB COLOR	PACKAGE	CATEGORY	TENSION	POWERFUL	BASE	ORIGINAL
	GL82	Halogen Lamp	Incolor	Individual	H13	12V	60/55W	P26.4t	Philips: 9008-CI
H13	CODE	DESCRIPTION	BULB COLOR	PACKAGE	CATEGORY	TENSION	POWERFUL	BASE	ORIGINAL
	GL83	Halogen Lamp Max Light	Blue	Blister with 2 lamps	H13	12V	60/55W	PJ26.4t	-

HALOGEN

H15	CODE	DESCRIPTION	BULB COLOR	PACKAGE	CATEGORY	TENSION	POWERFUL	BASE	ORIGINAL
	GL114	Halogen Lamp	Incolor	Individual	H15	12V	55/15W	PGJ23t-1	Osram: 64176
	GL115	Halogen Lamp Max Light	Blue	Blister with 2 lamps	H15	12V	55/15W	PGJ23t-1	Osram: 64176CBI
H16	CODE	DESCRIPTION	BULB COLOR	PACKAGE	CATEGORY	TENSION	POWERFUL	BASE	ORIGINAL
	GL116	Halogen Lamp	Incolor	Individual	H16	12V	19W	PGJ19-3	Osram: 64219L+
	GL117	Halogen Lamp Max Light	Blue	Acrylic Box with 2 lamps	H16	12V	19W	PGJ19-3	Osram: 64219L+CBI
H21	CODE	DESCRIPTION	BULB COLOR	PACKAGE	CATEGORY	TENSION	POWERFUL	BASE	ORIGINAL
	GL49	Halogen Lamp	Incolor	Box with 10 units.	H21	24V	21W	BAY9S	-
	GL76	Halogen Lamp	Incolor	Individual	H21	12V	21W	BAY9S	-
H27W/1	CODE	DESCRIPTION	BULB COLOR	PACKAGE	CATEGORY	TENSION	POWERFUL	BASE	ORIGINAL
	GL880	Halogen Lamp	Incolor	Individual	H27W/1	12V	27W	PG13	Osram: 880
	GL880A	Halogen Lamp Max Light	Blue	Individual	H27W/1	12V	27W	PG13	Osram: 880 Max Light
	GL880B	Halogen Lamp Max Light	Blue	Blister with 2 lamps	H27W/1	12V	27W	PG13	Osram: 880 Max Light
H27W/2	CODE	DESCRIPTION	BULB COLOR	PACKAGE	CATEGORY	TENSION	POWERFUL	BASE	ORIGINAL
	GL881	Halogen Lamp	Incolor	Individual	H27W/2	12V	27W	PGJ13	Osram: 881
	GL881A	Halogen Lamp Max Light	Blue	Individual	H27W/2	12V	27W	PGJ13	Osram: 881 Max Light
	GL881B	Halogen Lamp Max Light	Blue	Blister with 2 lamps	H27W/2	12V	27W	PGJ13	Osram: 881 Max Light
H37	CODE	DESCRIPTION	BULB COLOR	PACKAGE	CATEGORY	TENSION	POWERFUL	BASE	ORIGINAL
	GL896	Halogen Lamp	Incolor	Individual	H37	12V	37,5W	PGJ13	Hella: 896
HB1	CODE	DESCRIPTION	BULB COLOR	PACKAGE	CATEGORY	TENSION	POWERFUL	BASE	ORIGINAL
	GL27	Halogen Lamp	Incolor	Individual	HB1	12V	65/45W	P29t	Osram: 9004
	GL29	Halogen Lamp	Incolor	Individual	HB1	12V	100/80W	P29t	-
	GL28	Halogen Lamp Max Light	Blue	Individual	HB1	12V	65/45W	P29t	Osram: 9004 Max Light
	GL96	Halogen Lamp Max Light	Blue	Blister with 2 lamps	HB1	12V	65/45W	P29t	Osram: 9004 Max Light
	GL30	Halogen Lamp Max Light	Blue	Individual	HB1	12V	100/80W	P29t	-

HALOGEN										
HB3	CODE	DESCRIPTION	BULB COLOR	PACKAGE	CATEGORY	TENSION	POWERFUL	BASE	ORIGINAL	
	GL31	Halogen Lamp	Incolor	Individual	HB3	12V	60W	P20d	Osram: 9005; Philips: 9005 HB3	
	GL33	Halogen Lamp	Incolor	Individual	HB3	12V	100W	P20d	-	
	GL32	Halogen Lamp Max Light	Blue	Individual	HB3	12V	60W	P20d	Osram: 9005-CBI; Philips: 9005 BV	
	GL34	Halogen Lamp Max Light	Blue	Individual	HB3	12V	100W	P20d	-	
	GL97	Halogen Lamp Max Light	Blue	Blister box with 2 lamps	HB3	12V	60W	P20d	Osram: 9005-CBI; Philips: 9005BV	
HB4	CODE	DESCRIPTION	BULB COLOR	PACKAGE	CATEGORY	TENSION	POWERFUL	BASE	ORIGINAL	
	GL35	Halogen Lamp	Incolor	Individual	HB4	12V	51W	P22d	Osram: 9006; Philips: 9006 HB4	
	GL37	Halogen Lamp	Incolor	Individual	HB4	12V	100W	P22d	-	
HB4	CODE	DESCRIPTION	BULB COLOR	PACKAGE	CATEGORY	TENSION	POWERFUL	BASE	ORIGINAL	
	GL36	Halogen Lamp Max Light	Blue	Individual	HB4	12V	51W	P22d	Osram: 9006-CBI; Philips: 9006BV	
	GL98	Halogen Lamp Max Light	Blue	Blister with 2 lamps	HB4	12V	51W	P22d	Osram: 9006-CBI; Philips: 9006BV	
	GL38	Halogen Lamp Max Light	Blue	Individual	HB4	12V	100W	P22d	-	
HB5	CODE	DESCRIPTION	BULB COLOR	PACKAGE	CATEGORY	TENSION	POWERFUL	BASE	ORIGINAL	
	GL39	Halogen Lamp	Incolor	Individual	HB5	12V	65/55W	PX29t	Osram: 9007; Philips: 9007 HB5	
	GL41	Halogen Lamp	Incolor	Individual	HB5	12V	100/80W	PX29t	-	
	GL40	Halogen Lamp Max Light	Blue	Individual	HB5	12V	65/55W	PX29t	Osram: 9007-CBI; Philips: 9007BV	
	GL42	Halogen Lamp Max Light	Blue	Individual	HB5	12V	100/80W	PX29t	-	
	GL99	Halogen Lamp Max Light	Blue	Blister box with 2 lamps	HB5	12V	65/55W	PX29t	Osram: 9007-CBI; Philips: 9007BV	
HS025	CODE	DESCRIPTION	BULB COLOR	PACKAGE	CATEGORY	TENSION	POWERFUL	BASE	ORIGINAL	
	GL43M5	Halogen Lamp	Incolor	Individual	HS025	12V	35/35W		-	
	GL63M5	Halogen Lamp Max Light	Blue	Individual	HS025	12V	35/35W		-	
HS1	CODE	DESCRIPTION	BULB COLOR	PACKAGE	CATEGORY	TENSION	POWERFUL	BASE	ORIGINAL	
	GL50	Halogen Lamp	Incolor	Individual	HS1	12V	35/35W	PX43t-38	Osram: 64185	
	GL151	Halogen Lamp Max Light	Blue	Blister with 1 lamp	HS1	12V	35/35W	PX43t-38	Osram: 64185 Philips: 12636C1	

HALOGEN

HS5	CODE	DESCRIPTION	BULB COLOR	PACKAGE	CATEGORY	TENSION	POWERFUL	BASE	ORIGINAL
-----	------	-------------	------------	---------	----------	---------	----------	------	----------



GL150	Halogen Lamp	Incolor	Individual	HS5	12V	35/30W	P23t	Honda: 34901-GFM-971
-------	--------------	---------	------------	-----	-----	--------	------	----------------------

HV025	CODE	DESCRIPTION	BULB COLOR	PACKAGE	CATEGORY	TENSION	POWERFUL	BASE	ORIGINAL
-------	------	-------------	------------	---------	----------	---------	----------	------	----------



GL64Q5	Halogen Lamp	Incolor	Individual	HV025	12V	35/35W		-
--------	--------------	---------	------------	-------	-----	--------	--	---



GL65Q5	Halogen Lamp Max Light	Blue	Individual	HV025	12V	35/35W		-
--------	------------------------	------	------------	-------	-----	--------	--	---

P13W	CODE	DESCRIPTION	BULB COLOR	PACKAGE	CATEGORY	TENSION	POWERFUL	BASE	ORIGINAL
------	------	-------------	------------	---------	----------	---------	----------	------	----------



GL156	Halogen Lamp	Incolor	Individual	P13W	12V	13W	PG18.5d-1	Philips: 12277C1
-------	--------------	---------	------------	------	-----	-----	-----------	------------------

PSX24W	CODE	DESCRIPTION	BULB COLOR	PACKAGE	CATEGORY	TENSION	POWERFUL	BASE	ORIGINAL
--------	------	-------------	------------	---------	----------	---------	----------	------	----------



GL84	Halogen Lamp	Incolor	Individual	PSX24W	12V	24W	PG20/7	Philips: 12276C1
------	--------------	---------	------------	--------	-----	-----	--------	------------------



GL152	Halogen Lamp	Incolor	Blister with 1 lamp	PSX24W	12V	24W	PG20/7	Philips: 12276C1
-------	--------------	---------	---------------------	--------	-----	-----	--------	------------------

GL85	Halogen Lamp Max Light	Blue	Acrylic Box with 2 lamps	PSX24W	12V	24W	PG20/7	Philips: 12276NBV-B1
------	------------------------	------	--------------------------	--------	-----	-----	--------	----------------------

PSX26W	CODE	DESCRIPTION	BULB COLOR	PACKAGE	CATEGORY	TENSION	POWERFUL	BASE	ORIGINAL
--------	------	-------------	------------	---------	----------	---------	----------	------	----------



GL162	Halogen Lamp	Incolor	Individual	PSX26W	12V	26W	PG18.5d-3	Philips: 12278C1 Flosser: 38874933
-------	--------------	---------	------------	--------	-----	-----	-----------	---------------------------------------

HIR2	CODE	DESCRIPTION	BULB COLOR	PACKAGE	CATEGORY	TENSION	POWERFUL	BASE	ORIGINAL
------	------	-------------	------------	---------	----------	---------	----------	------	----------



GL163	Halogen Lamp	Incolor	Individual	HIR2	12V	55W	PX22d	Philips: 9012C1
-------	--------------	---------	------------	------	-----	-----	-------	-----------------

S2	CODE	DESCRIPTION	BULB COLOR	PACKAGE	CATEGORY	TENSION	POWERFUL	BASE	ORIGINAL
----	------	-------------	------------	---------	----------	---------	----------	------	----------



GL12728	Halogen Lamp	Incolor	Individual	S2	12V	35/35W		Philips: 12728C1
---------	--------------	---------	------------	----	-----	--------	--	------------------

LED

L101W2	CODE	DESCRIPTION	BULB COLOR	PACKAGE	CATEGORY	TENSION	POWERFUL	BASE	ORIGINAL
--------	------	-------------	------------	---------	----------	---------	----------	------	----------



GL51	LED Lamp	Incolor	Blister with 2 lamps	L101W2	12V	6000 MCD	W2.1*9.5d	-
------	----------	---------	----------------------	--------	-----	----------	-----------	---

L101B2	CODE	DESCRIPTION	BULB COLOR	PACKAGE	CATEGORY	TENSION	POWERFUL	BASE	ORIGINAL
--------	------	-------------	------------	---------	----------	---------	----------	------	----------



GL52	LED Lamp Max Light	Blue	Blister with 2 lamps	L101B2	12V	6001 MCD	W2.1*9.5d	-
------	--------------------	------	----------------------	--------	-----	----------	-----------	---

LED										
L102W2	CODE	DESCRIPTION	BULB COLOR	PACKAGE	CATEGORY	TENSION	POWERFUL	BASE	ORIGINAL	
	GL53	LED Lamp	Incolor	Blister with 2 lamps	L102W2	12V	5000 MCD	W2.1*9.5d	-	
L102B2	CODE	DESCRIPTION	BULB COLOR	PACKAGE	CATEGORY	TENSION	POWERFUL	BASE	ORIGINAL	
	GL54	LED Lamp Max Light	Blue	Blister with 2 lamps	L102B2	12V	5000 MCD	W2.1*9.5d	-	
SMD	CODE	DESCRIPTION	BULB COLOR	PACKAGE	CATEGORY	TENSION	POWERFUL	BASE	ORIGINAL	
	GL300	LED Lamp 18X5050SMD	Incolor	Blister with 2 lamps	P21/5W	12V	21/5W	BAY15D	-	
	GL301	LED Lamp 18X5050SMD	Incolor	Box with 10 lamps	P21/5W	12V	21/5W	BAY15D	-	
	GL302	LED Lamp 18X5050SMD	Incolor	Blister with 2 lamps	P21/5W	24V	21/5W	BAY15D	-	
	GL303	LED Lamp 18X5050SMD	Incolor	Box with 10 lamps	P21/5W	24V	21/5W	BAY15D	-	
	GL304	LED Lamp 13X5050SMD	Incolor	Blister with 2 lamps	P21W	12V	21W	BA15S	-	
	GL305	LED Lamp 13X5050SMD	Incolor	Box with 10 lamps	P21W	12V	21W	BA15S	-	
	GL306	LED Lamp 13X5050SMD	Incolor	Blister with 2 lamps	P21W	24V	21W	BA15S	-	
	GL307	LED Lamp 13X5050SMD	Incolor	Box with 10 lamps	P21W	24V	21W	BA15S	-	
	GL312	LED Lamp 8X2835SMD	Incolor	Blister with 2 lamps	R5W	12V	4W	BA15S	-	
	GL313	LED Lamp 8X2835SMD	Incolor	Box with 10 lamps	R5W	12V	4W	BA15S	-	
	GL314	LED Lamp 9X2835SMD	Incolor	Blister with 2 lamps	R5W	24V	4W	BA15S	-	
	GL315	LED Lamp 9X2835SMD	Incolor	Box with 10 lamps	R5W	24V	4W	BA15S	-	
	GL324	LED Lamp T11X41 12X2835SMD	Incolor	Blister with 2 lamps	C10W	12V	10W	SV8.5	-	
	GL325	LED Lamp T11X41 12X2835SMD	Incolor	Box with 10 lamps	C10W	12V	10W	SV8.5	-	
	GL326	LED Lamp T11X41 12X2835SMD	Incolor	Blister with 2 lamps	C10W	24V	10W	SV8.5	-	
	GL327	LED Lamp T11X41 12X2835SMD	Incolor	Box with 10 lamps	C10W	24V	10W	SV8.5	-	
	GL328	LED Lamp T11X36 6X2835SMD	Incolor	Blister with 2 lamps	C5W	12V	5W	SV8.5	-	
	GL329	LED Lamp T11X36 6X2835SMD	Incolor	Box with 10 lamps	C5W	12V	5W	SV8.5	-	
	GL330	LED Lamp T11X36 6X2835SMD	Incolor	Blister with 2 lamps	C5W	24V	5W	SV8.5	-	
	GL331	LED Lamp T11X36 6X2835SMD	Incolor	Box with 10 lamps	C5W	24V	5W	SV8.5	-	
1 CHIP	CODE	DESCRIPTION	BULB COLOR	PACKAGE	CATEGORY	TENSION	POWERFUL	BASE	ORIGINAL	
	GL308	LED Lamp	Incolor	Blister with 2 lamps	T4W	12V	4W	BA9S	-	
	GL309	LED Lamp	Incolor	Box with 10 lamps	T4W	12V	4W	BA9S	-	
	GL310	LED Lamp	Incolor	Blister with 2 lamps	T4W	24V	4W	BA9S	-	
	GL311	LED Lamp	Incolor	Box with 10 lamps	T4W	24V	4W	BA9S	-	
1 LED COB	CODE	DESCRIPTION	BULB COLOR	PACKAGE	CATEGORY	TENSION	POWERFUL	BASE	ORIGINAL	
	GL316	LED Lamp	Incolor	Blister with 2 lamps	W1.2W	12V	1.2W	W2X4.6D	-	
	GL317	LED Lamp	Incolor	Box with 10 lamps	W1.2W	12V	1.2W	W2X4.6D	-	
	GL318	LED Lamp	Incolor	Blister with 2 lamps	W1.2W	24V	1.2W	W2X4.6D	-	
	GL319	LED Lamp	Incolor	Box with 10 lamps	W1.2W	24V	1.2W	W2X4.6D	-	

LED									
1 LED POWER	CODE	DESCRIPTION	BULB COLOR	PACKAGE	CATEGORY	TENSION	POWERFUL	BASE	ORIGINAL
	GL320	1 LED WHITH LENS HIGH POWER	Incolor	Blister with 2 lamps	W5W	12V	5W	W2.1x9,5D	-
	GL321	1 LED WHITH LENS HIGH POWER	Incolor	Box with 10 lamps	W5W	12V	5W	W2.1x9,5D	-
	GL322	1 LED WHITH LENS HIGH POWER	Incolor	Blister with 2 lamps	W5W	24V	5W	W2.1x9,5D	-
	GL323	1 LED WHITH LENS HIGH POWER	Incolor	Box with 10 lamps	W5W	24V	5W	W2.1x9,5D	-
SPOT FLOOD	CODE	DESCRIPTION	BULB COLOR	PACKAGE	CATEGORY	TENSION	POWERFUL	BASE	ORIGINAL
	GL500	AUXILIARY LED HEADLIGHT	Incolor	Box with 1 lamp	-	9-32V	12x1W 900LM	-	-
	GL501	AUXILIARY LED HEADLIGHT	Incolor	Box with 1 lamp	-	9-32V	16x1W 1200LM	-	-
	GL502	AUXILIARY LED HEADLIGHT	Incolor	Box with 1 lamp	-	9-32V	24x1W 1800LM	-	-
	GL503	AUXILIARY LED HEADLIGHT	Incolor	Box with 1 lamp	-	9-32V	12x1W 900LM	-	-
	GL504	AUXILIARY LED HEADLIGHT	Incolor	Box with 1 lamp	-	9-32V	16x1W 1200LM	-	-
	GL505	AUXILIARY LED HEADLIGHT	Incolor	Box with 1 lamp	-	9-32V	30x1W 2250LM	-	-
	GL506	AUXILIARY LED HEADLIGHT	Incolor	Box with 1 lamp	-	9-32V	1x10W 800LM	-	-
	GL507	AUXILIARY LED HEADLIGHT	Incolor	Box with 1 lamp	-	9-32V	1x10W 800LM	-	-
	GL508	AUXILIARY LED HEADLIGHT	Incolor	Box with 1 lamp	-	9-32V	2x10W 1600LM	-	-
	GL509	AUXILIARY LED HEADLIGHT	Incolor	Box with 1 lamp	-	9-32V	4x10W 3200LM	-	-
SPOT FLOOD COMBO	CODE	DESCRIPTION	BULB COLOR	PACKAGE	CATEGORY	TENSION	POWERFUL	BASE	ORIGINAL
	GL510	AUXILIARY LED HEADLIGHT	Incolor	Box with 1 lamp	-	9-32V	6x10W 4800LM	-	-

SPOT	CODE	DESCRIPTION	BULB COLOR	PACKAGE	CATEGORY	TENSION	POWERFUL	BASE	ORIGINAL
	GL511	AUXILIARY LED HEADLIGHT	Incolor	Box with 1 lamp	-	9-32V	16x3W 3840LM	-	-
	GL512	AUXILIARY LED HEADLIGHT	Incolor	Box with 1 lamp	-	9-32V	9x3W 2160LM	-	-
LINE	CODE	DESCRIPTION	BULB COLOR	PACKAGE	CATEGORY	TENSION	POWERFUL	BASE	ORIGINAL
	GL513	AUXILIARY LED HEADLIGHT	Incolor	Box with 1 lamp	-	9-32V	4x5W 1400LM	-	-









MAX LIGHT PERFORMANCE

BRIGHTNESS + 110% DISTANCE + 40m LUMINOSITY + 20%

H1	CODE	DESCRIPTION	BULB COLOR	PACKAGE	CATEGORY	TENSION	POWERFUL	BASE	ORIGINAL
	GL120	MAX LIGHT PERFORMANCE Lamp	Blue + Colorless	Blister with 2 lamps	H1	12V	55W	-	-
H3	CODE	DESCRIPTION	BULB COLOR	PACKAGE	CATEGORY	TENSION	POWERFUL	BASE	ORIGINAL
	GL121	MAX LIGHT PERFORMANCE Lamp	Blue + Colorless	Blister with 2 lamps	H3	12V	55W	-	-
H4	CODE	DESCRIPTION	BULB COLOR	PACKAGE	CATEGORY	TENSION	POWERFUL	BASE	ORIGINAL
	GL122	MAX LIGHT PERFORMANCE Lamp	Blue + Colorless	Blister with 2 lamps	H4	12V	60/55W	-	-
H7	CODE	DESCRIPTION	BULB COLOR	PACKAGE	CATEGORY	TENSION	POWERFUL	BASE	ORIGINAL
	GL123	MAX LIGHT PERFORMANCE Lamp	Blue + Colorless	Blister with 2 lamps	H7	12V	55W	-	-
HB3	CODE	DESCRIPTION	BULB COLOR	PACKAGE	CATEGORY	TENSION	POWERFUL	BASE	ORIGINAL
	GL124	MAX LIGHT PERFORMANCE Lamp	Blue + Colorless	Blister with 2 lamps	HB3	12V	60W	-	-
HB4	CODE	DESCRIPTION	BULB COLOR	PACKAGE	CATEGORY	TENSION	POWERFUL	BASE	ORIGINAL
	GL125	MAX LIGHT PERFORMANCE Lamp	Blue + Colorless	Blister with 2 lamps	HB4	12V	51W	-	-

XENON

D1S	CODE	DESCRIPTION	BULB COLOR	PACKAGE	CATEGORY	TENSION	POWERFUL	BASE	ORIGINAL
	GL145	Xenon 4300K	Incolor	Individual	D1S	85V	35W	PK32d-2	Neolux: NX1S Osram: 66140 Philips: 85410 C1
D2S	CODE	DESCRIPTION	BULB COLOR	PACKAGE	CATEGORY	TENSION	POWERFUL	BASE	ORIGINAL
	GL146	Xenon 4300K	Incolor	Individual	D2S	85V	35W	P32d-2	Philips: 85122VIC1 Osram: 66240

XENON									
D3S	CODE	DESCRIPTION	BULB COLOR	PACKAGE	CATEGORY	TENSION	POWERFUL	BASE	ORIGINAL
	GL147	Xenon 4300K	Incolor	Individual	D3S	42V	35W	PK32d-5	Neolux: NX3S Philips: 42302 Osram: 66340
D4S	CODE	DESCRIPTION	BULB COLOR	PACKAGE	CATEGORY	TENSION	POWERFUL	BASE	ORIGINAL
	GL148	Xenon 4300K	Incolor	Individual	D4S	42V	35W	P32d-5	Neolux: NX4S Philips: 42402VIC1 Osram: 66440
D5S	CODE	DESCRIPTION	BULB COLOR	PACKAGE	CATEGORY	TENSION	POWERFUL	BASE	ORIGINAL
	GL160	Xenon 4300K	Incolor	Individual	D5S	12V	25W	PK32d-7	Philips: 12410C1
D8S	CODE	DESCRIPTION	BULB COLOR	PACKAGE	CATEGORY	TENSION	POWERFUL	BASE	ORIGINAL
	GL161	Xenon 4300K	Incolor	Individual	D8S	12V	25W	PK32d-1	Osram: 66548
D1R	CODE	DESCRIPTION	BULB COLOR	PACKAGE	CATEGORY	TENSION	POWERFUL	BASE	ORIGINAL
	GL158	Xenon 4300K	Incolor	Individual	D1R	85V	35W	PK32d-3	Osram: 66150
D2R	CODE	DESCRIPTION	BULB COLOR	PACKAGE	CATEGORY	TENSION	POWERFUL	BASE	ORIGINAL
	GL155	Xenon 4300K	Incolor	Individual	D2R	85V	35W	P32d-3	Philips: 85126 Osram: 66250 Narva: 84006 Toyota: 90981-20008
D3R	CODE	DESCRIPTION	BULB COLOR	PACKAGE	CATEGORY	TENSION	POWERFUL	BASE	ORIGINAL
	GL159	Xenon 4300K	Incolor	Individual	D3R	42V	35W	PK32d-6	Osram: 66350
D4R	CODE	DESCRIPTION	BULB COLOR	PACKAGE	CATEGORY	TENSION	POWERFUL	BASE	ORIGINAL
	GL149	Xenon 4300K	Incolor	Individual	D4R	42V	35W	P32d-6	Philips: 42406C1 Osram: 66450 Toyota: 90981-20029

BASES

BA15D	BA15S	BA9S	BAU15S	BAY15D	BAZ15D	P14.5S	P20D	P22D	P29T
P43T-38	PGJ19-2	PK22S	PX26D	PX29T	SV8.5	W2.1x9.5D	W2x4.6D	W3x16D	W3x16Q

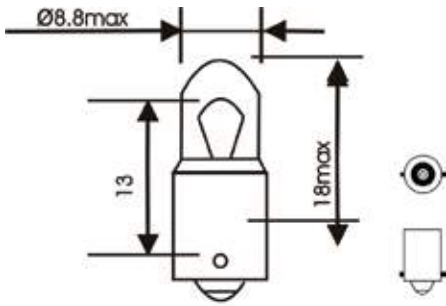
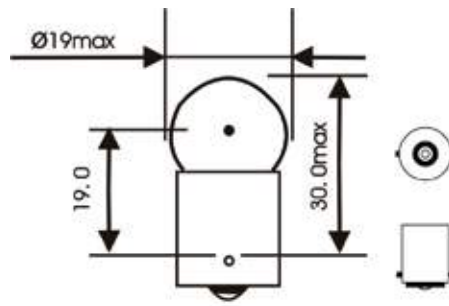
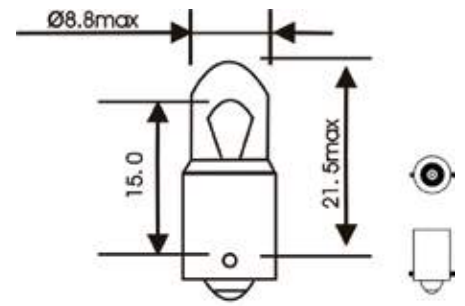
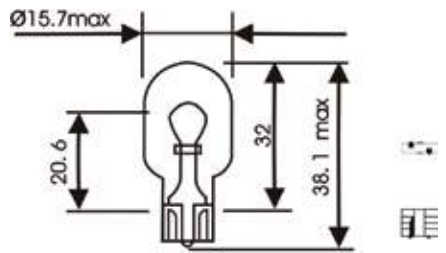
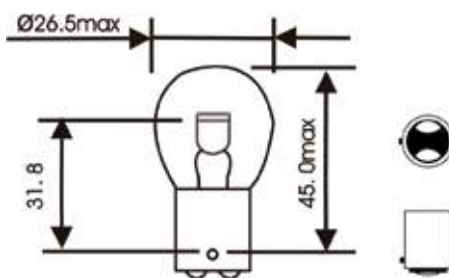
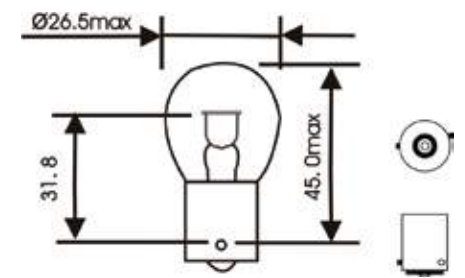
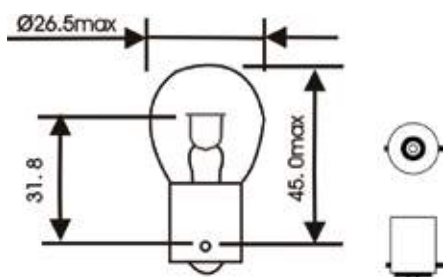
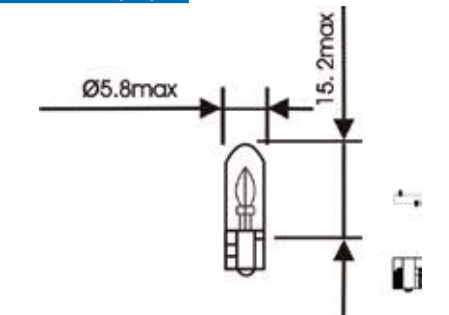
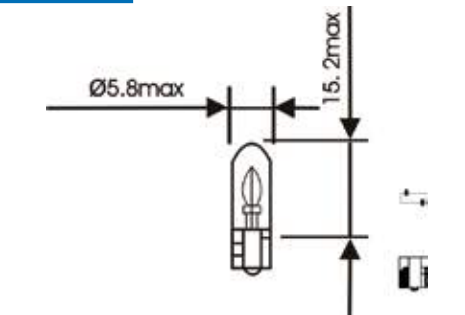
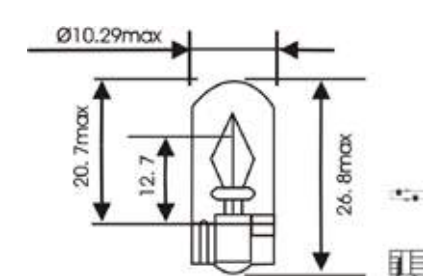
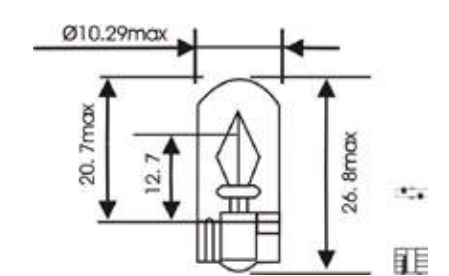
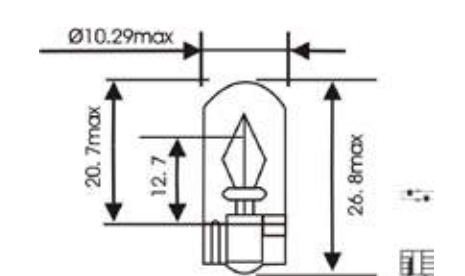
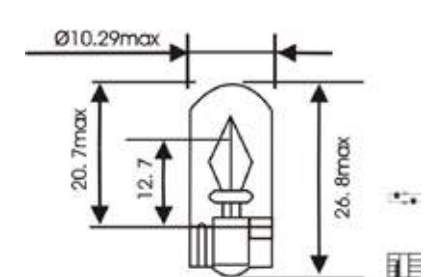
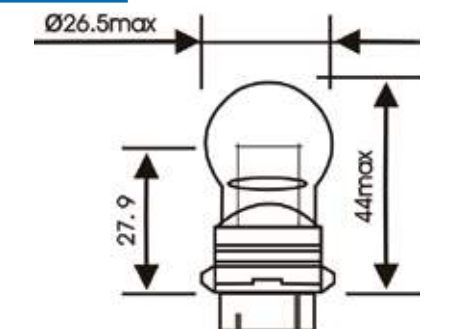
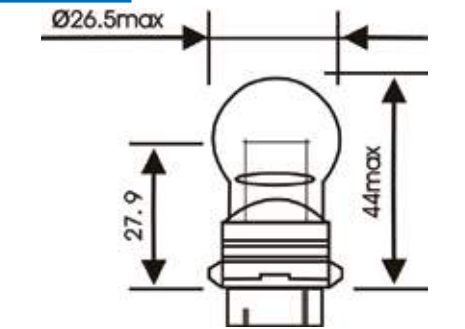
GL0053/A

GL0067/A/B/C

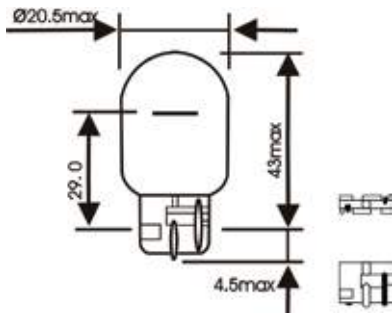
GL0069/A

GL921

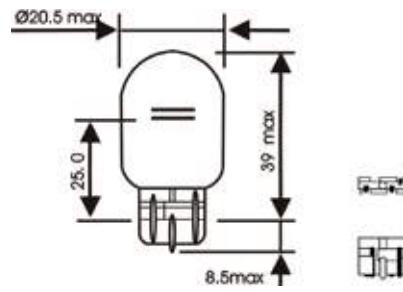
GL1034/A/B

GL1056/A/B

GL1141/A/B

GL2721/A/B

GL2722

GL2820

GL2821/A

GL2825/A/B

GL2840

GL3156

GL3157

GL7505



GL7515



H1

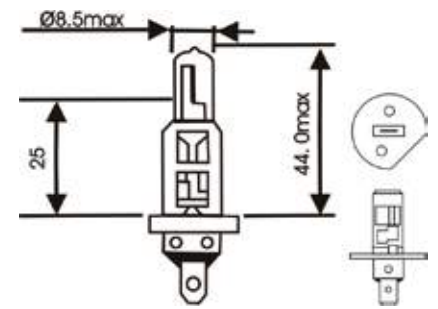

H3

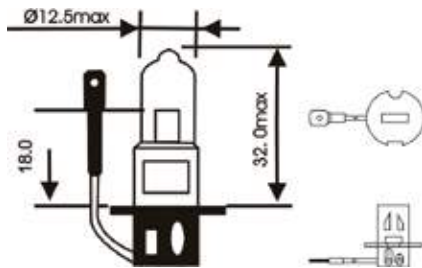

H4

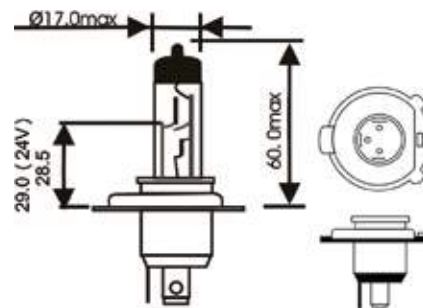

H7

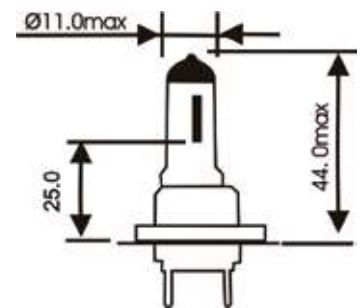

H8

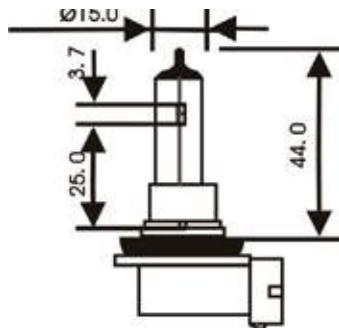

H9

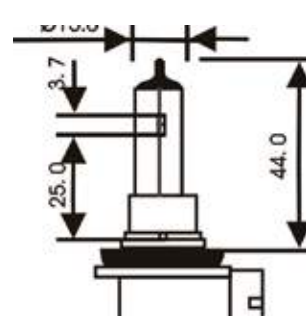

H11

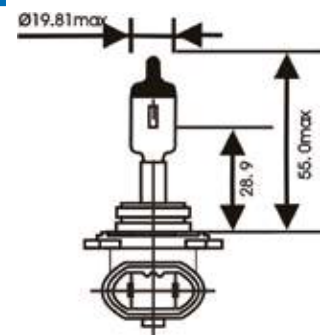

H21

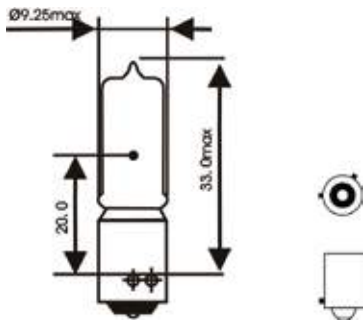

HB3

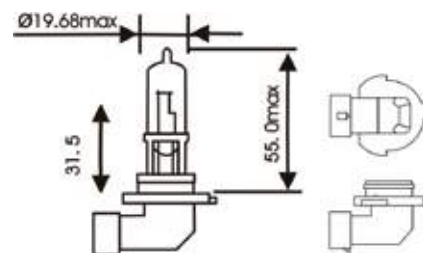



high beam



low beam



fog light



front indicators



side indicators



rear indicators



interior lights



front parking lights



rear positioning lights



glove compartment lights



stop lights



reversing lights



license plate lights

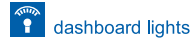

dashboard lights



trunk lights

max light version
max light and max light performance version



Application Guide

Application, see catalog



LAMPS WITH COMPULSORY CERTIFICATION

STAMP AND INMETRO REGISTER NUMBER AND E-MARK



Registration number by Category/ Gauss code as the following table

CATEGORY	GAUSS CODE	REGISTER 1	REGISTER 2	E-MARK
H7	GL19, GL20, GL48, GL61	007059/2014	008146/2017	GL19 / GL48 - E8
	GL94, GL129, GL134	-	008146/2017	-
H4	GL11, GL12, GL46, GL59, GL68	007063/2014	000045/2018	GL11 - E4 GL46 - E8
	GL93, GL128	-	000045/2018	-
H3	GL05, GL06, GL45, GL57	007064/2014	000044/2018	GL05 / GL45 - E8
	GL92, GL127, GL133	-	000044/2018	-
W21/5W	GL7515	007066/2014	000050/2018	-
W5W	GL2825, GL2825B	007067/2014	000049/2018	GL2825 - E4
	GL136	-	000049/2018	-
W3W	GL2821, GL2841	007070/2014	000068/2018	-
W1.2W	GL2721	007068/2014	000057/2018	-
T4W	GL0069, GL0069A	007073/2014	000056/2018	-
	GL137	-	000056/2018	-
T2W	GL0053	007076/2014	000055/2018	-
R10W	GL0067A, GL0067C	007077/2014	000054/2018	-
R5W	GL0067, GL74, GL0067B	007078/2014	000053/2018	GL0067B - E8
PY21W	GL1056A, GL1056B, GL1141A	007079/2014	008161/2017	-
	GL1056D, GL1056DC, GL135	-	008161/2017	-
P21W	GL1141, GL72, GL1141B	007080/2014	008159/2017	GL1141 - E4 GL1141B - E8
P21/5W	GL1034, GL70, GL1034B, GL1176A, GL1176	007081/2014	008158/2017	GL1034 - E4 GL1034B - E8
C5W	GL6418, GL6418A	007083/2014	008144/2017	-
HB4	GL35, GL36	007062/2014	008155/2017	-
	GL98	-	008155/2017	-
HB3	GL31, GL32	007061/2014	000051/2018	-
	GL97	-	000051/2018	-
H1	GL01, GL44, GL02, GL55	007057/2014	008145/2017	GL01 / GL44 - E8
	GL91, GL126, GL132	-	008145/2017	-
P21/4W	GL2560	006506/2014	008139/2017	-
W21W	GL7505	006507/2014	000048/2018	-
W2W	GL2722	005300/2015	000067/2018	-
W2.2W	GL2820	005298/2015	000064/2018	-
W2.5W	GL2840	005299/2015	000065/2018	-
H27W/1	GL880, GL880A, GL880B	005305/2015	000046/2018	-
H27W/2	GL881, GL881A, GL881B	005302/2015	000047/2018	-
HB1	GL27, GL28	005278/2015	008148/2017	-
	GL96	-	008148/2017	-
HS1	GL50	005301/2015	008143/2017	-
R2	GL4540	005303/2015	000052/2018	-
H6W	GL77	-	002923/2018	-
H21W	GL49, GL76	-	002924/2018	-
S2	GL12728	-	002926/2018	-



ELECTRICAL SPARE PART | PIEZA ELÉCTRICA

HORN | BOCINA

Now you can listen the sound of the horns in our website gauss.ind.br | Ahora es posible oír el sonidode las bocinas en nuestro sitio gauss.ind.br

GB1000
12V

CURRENT / CONDUCTA: 1.5A
 SOUND POWER / POTENCIA DE SONIDO: 100 ± 5 dB
 FREQUENCY / FRECUENCIA: 450 ± 20Hz
 FEATURES / CARACTERÍSTICAS: black color, with support
 TERMINALS / TERMINALES: 2 terminals
 DISC / DISCO: Ø70mm
 APPLICATION / APLICACIÓN: Universal - Motorcycles

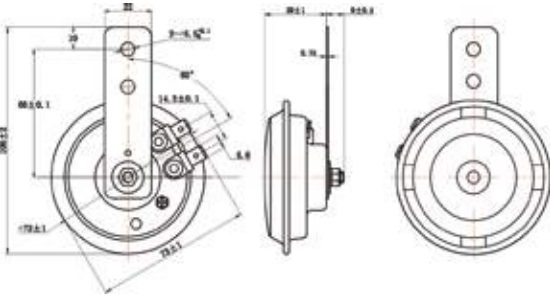
GB1001
12V

CURRENT / CONDUCTA: 1.5A
 SOUND POWER / POTENCIA DE SONIDO: 100 ± 5 dB
 FREQUENCY / FRECUENCIA: 450 ± 20Hz
 FEATURES / CARACTERÍSTICAS: black color, with support
 TERMINALS / TERMINALES: 2 terminals
 DISC / DISCO: Ø70mm
 APPLICATION / APLICACIÓN: Universal - Motorcycles

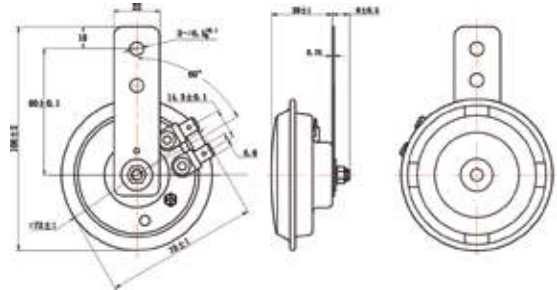
GB1002
12V

CURRENT / CONDUCTA: 1.5A
 SOUND POWER / POTENCIA DE SONIDO: 100 ± 5 dB
 FREQUENCY / FRECUENCIA: 450 ± 20Hz
 FEATURES / CARACTERÍSTICAS: aluminium color, with support
 TERMINALS / TERMINALES: 2 terminals
 DISC / DISCO: Ø70mm
 APPLICATION / APLICACIÓN: Universal - Motorcycles

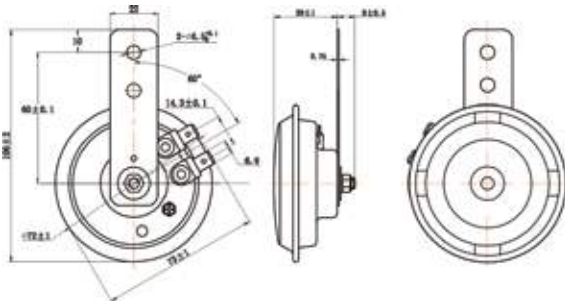
GB1003
12V

CURRENT / CONDUCTA: 4A
 SOUND POWER / POTENCIA DE SONIDO: ≥110dB
 FREQUENCY / FRECUENCIA: 450Hz
 FEATURES / CARACTERÍSTICAS: air horn, black color, with solenoid, with installation KIT
 HORN / ALARMA: 230 / 295mm
 APPLICATION / APLICACIÓN: Universal - Trucks (12V)

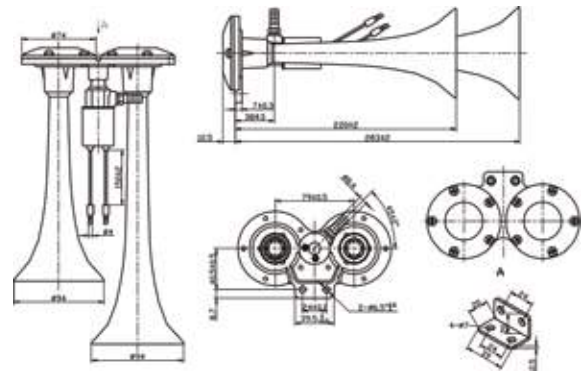
GB1004
24V

CURRENT / CONDUCTA: 4A
 SOUND POWER / POTENCIA DE SONIDO: ≥110dB
 FREQUENCY / FRECUENCIA: 450Hz
 FEATURES / CARACTERÍSTICAS: air horn, black color, with solenoid, with installation KIT
 HORN / ALARMA: 230 / 295mm
 APPLICATION / APLICACIÓN: Universal - Trucks (24V)

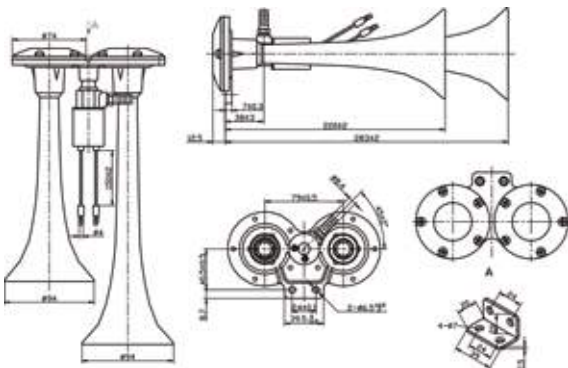

GB1005
12V

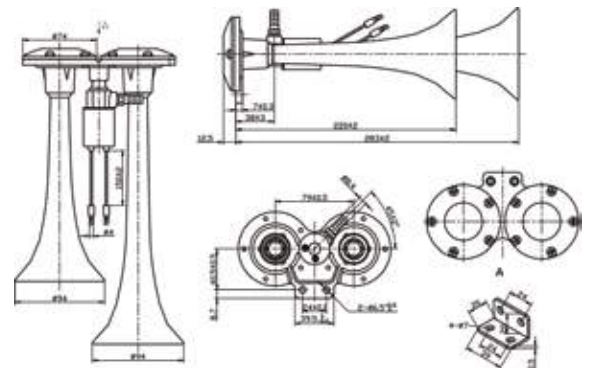
CURRENT / CONDUCTA: 4A
 SOUND POWER / POTENCIA DE SONIDO: ≥110dB
 FREQUENCY / FRECUENCIA: 450Hz
 FEATURES / CARACTERÍSTICAS: air horn, aluminium color, with solenoid, with installation KIT
 HORN / ALARMA: 230 / 295mm
 APPLICATION / APLICACIÓN: Universal - Trucks (12V)

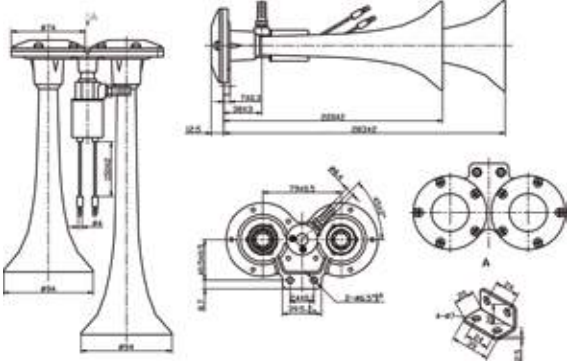

GB1006
24V

CURRENT / CONDUCTA: 4A
SOUND POWER / POTENCIA DE SONIDO: ≥ 110 dB
FREQUENCY / FRECUENCIA: 450Hz
FEATURES / CARACTERÍSTICAS: air horn, aluminium color, with solenoid, with installation KIT
HORN / ALARMA: 230 / 295mm
APPLICATION / APLICACIÓN: Universal - Trucks (24V)

GB1007
12V

CURRENT / CONDUCTA: 20A
SOUND POWER / POTENCIA DE SONIDO: ≥ 110 dB
FREQUENCY / FRECUENCIA: 680Hz
FEATURES / CARACTERÍSTICAS: electric air horn, aluminium color, with compresor, with installation KIT
HORN / ALARMA: 400mm
APPLICATION / APLICACIÓN: Universal - vehicles

GB1008
24V

CURRENT / CONDUCTA: 20A
SOUND POWER / POTENCIA DE SONIDO: ≥ 110 dB
FREQUENCY / FRECUENCIA: 680Hz
FEATURES / CARACTERÍSTICAS: electric air horn, aluminium color, with compresor, with installation KIT
HORN / ALARMA: 400mm
APPLICATION / APLICACIÓN: Universal - vehicles

GB1009
12V

CURRENT / CONDUCTA: 20A
SOUND POWER / POTENCIA DE SONIDO: ≥ 110 dB
FREQUENCY / FRECUENCIA: 680Hz
FEATURES / CARACTERÍSTICAS: electric air horn, aluminium color, with compresor, with installation KIT
HORN / ALARMA: 485mm
APPLICATION / APLICACIÓN: Universal - vehicles

GB1010
24V

CURRENT / CONDUCTA: 20A
SOUND POWER / POTENCIA DE SONIDO: ≥ 110 dB
FREQUENCY / FRECUENCIA: 680Hz
FEATURES / CARACTERÍSTICAS: electric air horn, aluminium color, with compresor, with installation KIT
HORN / ALARMA: 485mm
APPLICATION / APLICACIÓN: Universal - vehicles

GB1011
12V

CURRENT / CONDUCTA: 20A
SOUND POWER / POTENCIA DE SONIDO: ≥ 110 dB
FREQUENCY / FRECUENCIA: 680Hz
FEATURES / CARACTERÍSTICAS: electric air horn, black color, with compresor, with installation KIT
HORN / ALARMA: 485mm
APPLICATION / APLICACIÓN: Universal - vehicles

GB1012
24V

CURRENT / CONDUCTA: 20A
SOUND POWER / POTENCIA DE SONIDO: ≥ 110 dB
FREQUENCY / FRECUENCIA: 680Hz
FEATURES / CARACTERÍSTICAS: electric air horn, black color, with compresor, with installation KIT
HORN / ALARMA: 485mm
APPLICATION / APLICACIÓN: Universal - vehicles

GB1013
12V

CURRENT / CONDUCTA: 4A
SOUND POWER / POTENCIA DE SONIDO: ≥ 110 dB
FREQUENCY / FRECUENCIA: 450Hz
FEATURES / CARACTERÍSTICAS: air horn, aluminium color, with solenoid, with installation KIT
HORN / ALARMA: 165 / 230 / 295mm
APPLICATION / APLICACIÓN: Universal - Trucks (12V)

GB1014
24V

CURRENT / CONDUCTA: 4A
SOUND POWER / POTENCIA DE SONIDO: ≥ 110 dB
FREQUENCY / FRECUENCIA: 450Hz
FEATURES / CARACTERÍSTICAS: air horn, aluminium color, with solenoid, with installation KIT
HORN / ALARMA: 165 / 230 / 295mm
APPLICATION / APLICACIÓN: Universal - Trucks (24V)

GB1015
12V

CURRENT / CONDUCTA: 4A
SOUND POWER / POTENCIA DE SONIDO: ≥ 110 dB
FREQUENCY / FRECUENCIA: 450Hz
FEATURES / CARACTERÍSTICAS: air horn, aluminium color, with solenoid, with installation KIT
HORN / ALARMA: 640mm
APPLICATION / APLICACIÓN: Universal - vehicles



GB1016
24V

CURRENT / CONDUCTA: 4A
 SOUND POWER / POTENCIA DE SONIDO: ≥ 110 dB
 FREQUENCY / FRECUENCIA: 450Hz
 FEATURES / CARACTERÍSTICAS: air horn, aluminium color, with solenoid, with installation KIT
 HORN / ALARMA: 640mm
 APPLICATION / APLICACIÓN: Universal - vehicles

GB1017
12V

CURRENT / CONDUCTA: 4A
 SOUND POWER / POTENCIA DE SONIDO: ≥ 110 dB
 FREQUENCY / FRECUENCIA: 450Hz
 FEATURES / CARACTERÍSTICAS: air horn, aluminium color, with solenoid, with installation KIT
 HORN / ALARMA: 640mm
 APPLICATION / APLICACIÓN: Universal - vehicles

GB1018
24V

CURRENT / CONDUCTA: 4A
 SOUND POWER / POTENCIA DE SONIDO: ≥ 110 dB
 FREQUENCY / FRECUENCIA: 450Hz
 FEATURES / CARACTERÍSTICAS: air horn, aluminium color, with solenoid, with installation KIT
 HORN / ALARMA: 640mm
 APPLICATION / APLICACIÓN: Universal - vehicles

GB1019
12V

CURRENT / CONDUCTA: 3A
 SOUND POWER / POTENCIA DE SONIDO: ≥ 110 dB
 FREQUENCY / FRECUENCIA: 490Hz
 FEATURES / CARACTERÍSTICAS: electric air horn, red color, with compresor, with installation KIT + Relay
 HORN / ALARMA: 225mm
 APPLICATION / APLICACIÓN: Universal - vehicles

GB1020
24V

CURRENT / CONDUCTA: 4.5A
 SOUND POWER / POTENCIA DE SONIDO: 110 ± 5 dB
 FREQUENCY / FRECUENCIA: LT: 510 ± 20 HZ
 FEATURES / CARACTERÍSTICAS: black color, with support
 TERMINALS / TERMINALES: 2 terminals
 SNAIL / CARACOL: $\varnothing 90$ mm
 APPLICATION / APLICACIÓN: Universal - vehicles

GB1021
24V

CURRENT / CONDUCTA: 4.5A
 SOUND POWER / POTENCIA DE SONIDO: 110 ± 5 dB
 FREQUENCY / FRECUENCIA: HT: 510 ± 20 HZ / LT: 410 ± 20 HZ
 FEATURES / CARACTERÍSTICAS: black color, with support, high and low tone
 TERMINALS / TERMINALES: 1 terminal
 SNAIL / CARACOL: $\varnothing 90$ mm
 APPLICATION / APLICACIÓN: Universal - vehicles

GB1022
24V

CURRENT / CONDUCTA: 4.5A
 SOUND POWER / POTENCIA DE SONIDO: 110 ± 5 dB
 FREQUENCY / FRECUENCIA: HT: 510 ± 20 HZ / LT: 410 ± 20 HZ
 FEATURES / CARACTERÍSTICAS: black color, with support, high and low tone
 TERMINALS / TERMINALES: 2 terminals
 SNAIL / CARACOL: $\varnothing 90$ mm
 APPLICATION / APLICACIÓN: Universal - vehicles

GB1022R
24V

CURRENT / CONDUCTA: 4.5A
 SOUND POWER / POTENCIA DE SONIDO: 110 ± 5 dB
 FREQUENCY / FRECUENCIA: HT: 510 ± 20 HZ / LT: 410 ± 20 HZ
 FEATURES / CARACTERÍSTICAS: black color, with support, high and low tone
 TERMINALS / TERMINALES: 2 terminals
 SNAIL / CARACOL: $\varnothing 90$ mm
 APPLICATION / APLICACIÓN: Universal - vehicles
 P.S: Same the GB1022 + Relay 24V - 30A

GB1023
12V

CURRENT / CONDUCTA: 4.0A
 SOUND POWER / POTENCIA DE SONIDO: 110 ± 5 dB
 FREQUENCY / FRECUENCIA: HT: 510 ± 20 HZ
 FEATURES / CARACTERÍSTICAS: black color, with VW standard support, high tone
 TERMINALS / TERMINALES: 2 terminals
 SNAIL / CARACOL: $\varnothing 80$ mm
 APPLICATION / APLICACIÓN: Seat: Ibiza V 2008>; Skoda: Fabia 2007>2015, Assento Roomster 2006>2015; VW: Polo 2001>2009

GB1024
12V

CURRENT / CONDUCTA: 4.0A
 SOUND POWER / POTENCIA DE SONIDO: 110 ± 5 dB
 FREQUENCY / FRECUENCIA: HT: 510 ± 20 HZ / LT: 410 ± 20 HZ
 FEATURES / CARACTERÍSTICAS: black color, with VW standard support, high and low tone
 TERMINALS / TERMINALES: 2 terminals
 SNAIL / CARACOL: $\varnothing 80$ mm
 APPLICATION / APLICACIÓN: VW: Polo/ Derby 2002>2012, Polo Classic 2004>2006, Polo Lim (Sedan) 2004>2006

GB1025
12V // NEW //

CURRENT / CONDUCTA: 3.5-4.5A
 SOUND POWER / POTENCIA DE SONIDO: 110 ± 5 dB
 FREQUENCY / FRECUENCIA: LT: 410 ± 20 HZ
 FEATURES / CARACTERÍSTICAS: black color, low tone
 TERMINALS / TERMINALES: 2 terminals
 SNAIL / CARACOL: $\varnothing 85$ mm
 REPLACES / REEMPLAZA: Chevrolet: 52055807, 52036806, 52055809, 94745472, 94777875
 APPLICATION / APLICACIÓN: Chevrolet: Onix / Prisma 2013>2019, Cobalt 2012>2019

GB1026
12V // NEW //

CURRENT / CONDUCTA: 3.5-4.5A
 SOUND POWER / POTENCIA DE SONIDO: 110 ± 5 dB
 FREQUENCY / FRECUENCIA: HT: 490 ± 20 HZ
 FEATURES / CARACTERÍSTICAS: black color, high tone
 TERMINALS / TERMINALES: 2 terminals
 SNAIL / CARACOL: $\varnothing 85$ mm
 REPLACES / REEMPLAZA: Chevrolet: 52055808, 52044306, 52026029, 52137483
 APPLICATION / APLICACIÓN: Chevrolet: Spin 2013>2019

GB1027
12V // NEW //

CURRENT / CONDUCTA: 3-4A
 SOUND POWER / POTENCIA DE SONIDO: 110 ± 5 dB
 FREQUENCY / FRECUENCIA: LT: 335 ± 20 HZ
 FEATURES / CARACTERÍSTICAS: black color, low tone
 TERMINALS / TERMINALES: 2 terminals
 SNAIL / CARACOL: $\varnothing 80$ mm
 REPLACES / REEMPLAZA: Chevrolet: 52089719, 94728289
 APPLICATION / APLICACIÓN: Chevrolet: Trailblazer 2013>2019, S10 Simple Cabin 2012>2019, S10 Double Cabin 2012>2019

GB1028
12V // NEW //

CURRENT / CONDUCTA: 3-4A
 SOUND POWER / POTENCIA DE SONIDO: 110 ± 5 dB
 FREQUENCY / FRECUENCIA: HT: 400 ± 20 HZ
 FEATURES / CARACTERÍSTICAS: black color, high tone
 TERMINALS / TERMINALES: 2 terminals
 SNAIL / CARACOL: $\varnothing 80$ mm
 REPLACES / REEMPLAZA: Chevrolet: 52116395, 52082287
 APPLICATION / APLICACIÓN: Chevrolet: Trailblazer 2013>2019, S10 Simple Cabin 2012>2019, S10 Double Cabin 2012>2019



GB1029

12V ~ 24V (Bivolt) // NEW //

CURRENT / CONDUCTA: <4A
 SOUND POWER / POTENCIA DE SONIDO: 105 ± 118 dB
 LENGHT / LONGITUD: 1000mm
 PRESSURE / PRESIÓN: 0,3~1,0MPa (3,0~10,0 bar)
 APPLICATION / APLICACIÓN: Universal - trucks

GB1034

12V // NEW //

CURRENT / CONDUCTA: <4A
 SOUND POWER / POTENCIA DE SONIDO: 110 ± 5 dB
 FREQUENCY / FRECUENCIA: HT: 510 ± 20HZ /LT: 410± 20HZ
 FEATURES / CARACTERÍSTICAS: black color
 TERMINALS / TERMINALES: 2 terminals
 SNAIL / CARACOL: Ø80mm
 APPLICATION / APLICACIÓN: VW: Polo/Derby 2002>2012, Polo Classic 2004>2006, Polo Lim (Sedan) 2004>2006

GB1040

12V

CURRENT / CONDUCTA: 4.5A
 SOUND POWER / POTENCIA DE SONIDO: 110 ± 5 dB
 FREQUENCY / FRECUENCIA: HT: 510±20HZ
 FEATURES / CARACTERÍSTICAS: black color, with support, standard connector Reanult
 TERMINALS / TERMINALES: 1 terminal
 SNAIL / CARACOL: Ø90mm
 APPLICATION / APLICACIÓN: RENAULT: Clio, Kangoo

GB1041

12V

CURRENT / CONDUCTA: 4.5A
 SOUND POWER / POTENCIA DE SONIDO: 110 ± 5 dB
 FREQUENCY / FRECUENCIA: HT: 510±20HZ
 FEATURES / CARACTERÍSTICAS: black color, with support, standard connector Citroën / Peugeot / Toyota
 TERMINALS / TERMINALES: 2 terminals
 SNAIL / CARACOL: Ø90mm
 APPLICATION / APLICACIÓN:
 PEUGEOT: 205, 206, 405
 CITROËN: Xantia, Picasso, C5, ZX
 TOYOTA: Corolla 2003>
 REPLACES / REEMPLAZA: Peugeot: 6236.E3;
 Toyota: 8652002060

GB1050

12V

CURRENT / CONDUCTA: 4.5A
 SOUND POWER / POTENCIA DE SONIDO: 110 ± 5 dB
 FREQUENCY / FRECUENCIA: HT: 510±20HZ
 FEATURES / CARACTERÍSTICAS: black color, with support
 TERMINALS / TERMINALES: 1 terminal
 SNAIL / CARACOL: Ø90mm
 APPLICATION / APLICACIÓN: Universal - vehicles

GB1051

12V

CURRENT / CONDUCTA: 4.5A
 SOUND POWER / POTENCIA DE SONIDO: 110 ± 5 dB
 FREQUENCY / FRECUENCIA: HT: 510±20HZ
 FEATURES / CARACTERÍSTICAS: black color, with support, standard connector Bull Dog - GM
 TERMINALS / TERMINALES: 2 terminals
 SNAIL / CARACOL: Ø90mm
 APPLICATION / APLICACIÓN: GM: vehicles 95>

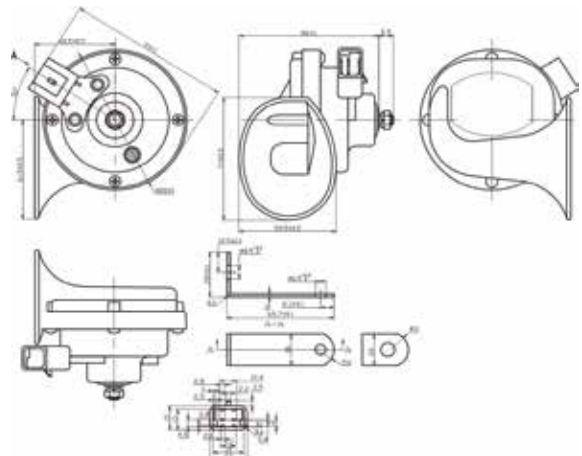

GB1052
12V

CURRENT / CONDUCTA: 4.5A
SOUND POWER / POTENCIA DE SONIDO: 110 ± 5 dB
FREQUENCY / FRECUENCIA: HT: 510±20HZ
FEATURES / CARACTERÍSTICAS: black color, with support
TERMINALS / TERMINALES: 2 terminals
SNAIL / CARACOL: Ø90mm
APPLICATION / APLICACIÓN: Universal - vehicles

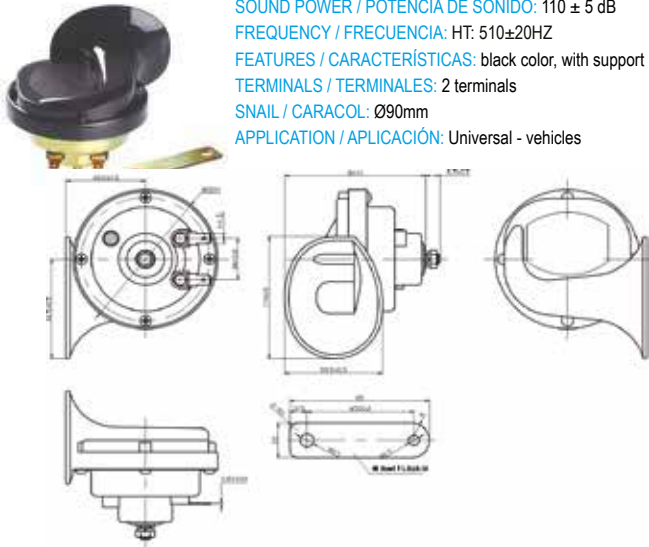
GB1053
12V

CURRENT / CONDUCTA: 4.5A
SOUND POWER / POTENCIA DE SONIDO: 110 ± 5 dB
FREQUENCY / FRECUENCIA: HT: 510±20HZ / LT: 410±20HZ
FEATURES / CARACTERÍSTICAS: black color, with support, high and low tone
TERMINALS / TERMINALES: 1 terminal
SNAIL / CARACOL: Ø90mm
APPLICATION / APLICACIÓN: Universal - vehicles

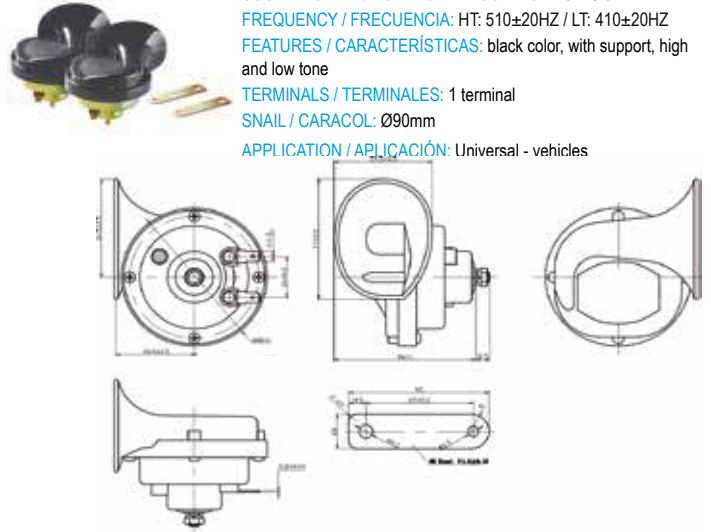
GB1054
12V

CURRENT / CONDUCTA: 4.5A
SOUND POWER / POTENCIA DE SONIDO: 110 ± 5 dB
FREQUENCY / FRECUENCIA: HT: 510±20HZ / LT: 410±20HZ
FEATURES / CARACTERÍSTICAS: black color, with support, high and low tone
TERMINALS / TERMINALES: 2 terminals
SNAIL / CARACOL: Ø90mm
APPLICATION / APLICACIÓN: Universal - vehicles

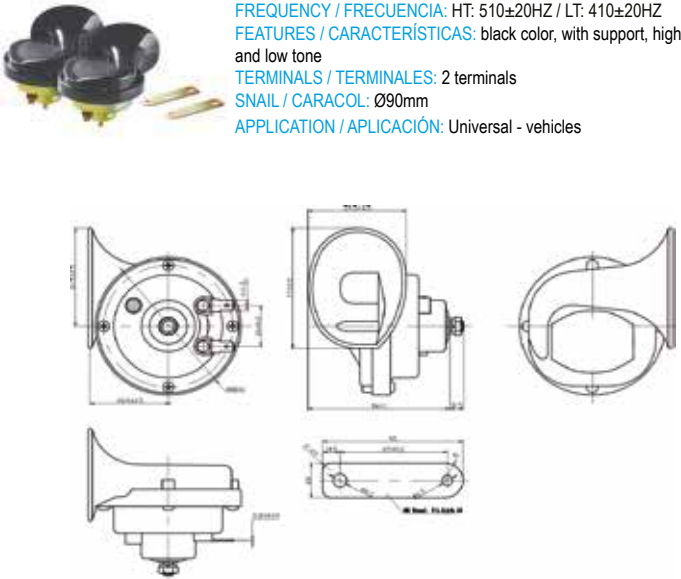

GB1054R
12V

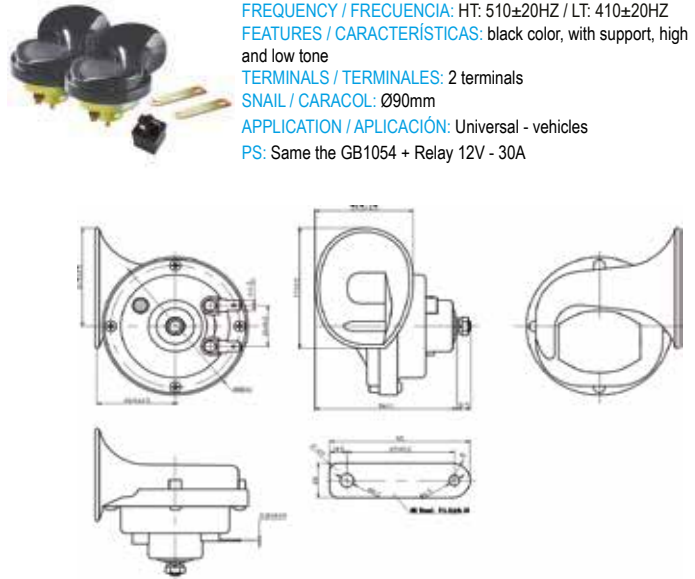
CURRENT / CONDUCTA: 4.5A
SOUND POWER / POTENCIA DE SONIDO: 110 ± 5 dB
FREQUENCY / FRECUENCIA: HT: 510±20HZ / LT: 410±20HZ
FEATURES / CARACTERÍSTICAS: black color, with support, high and low tone
TERMINALS / TERMINALES: 2 terminals
SNAIL / CARACOL: Ø90mm
APPLICATION / APLICACIÓN: Universal - vehicles
PS: Same the GB1054 + Relay 12V - 30A

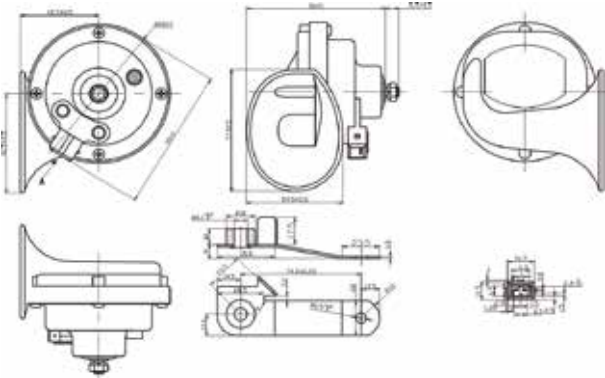

GB1055
12V

CURRENT / CONDUCTA: 4.5A
SOUND POWER / POTENCIA DE SONIDO: 110 ± 5 dB
FREQUENCY / FRECUENCIA: HT: 510±20HZ
FEATURES / CARACTERÍSTICAS: black color, with support, standard connector Fiat
TERMINALS / TERMINALES: 2 terminals
SNAIL / CARACOL: Ø90mm
APPLICATION / APLICACIÓN: FIAT: Palio (ED/EL/EDX), Weekend, Siena

GB1057
12V

CURRENT / CONDUCTA: 4.5A
SOUND POWER / POTENCIA DE SONIDO: 110 ± 5 dB
FREQUENCY / FRECUENCIA: HT: 510±20HZ
FEATURES / CARACTERÍSTICAS: black color, with support, standard connector VW
TERMINALS / TERMINALES: 2 terminals
SNAIL / CARACOL: Ø90mm
APPLICATION / APLICACIÓN: VW: Gol, Parati, Saveiro, Fox - all 98>

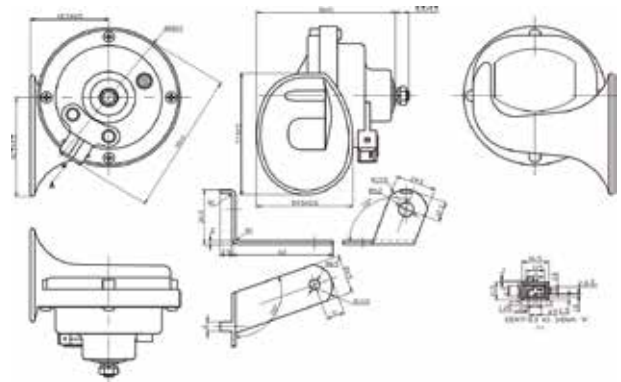
GB1059
12V

CURRENT / CONDUCTA: 3.5A
SOUND POWER / POTENCIA DE SONIDO: 110 ± 5 dB
FREQUENCY / FRECUENCIA: HT: 410±20HZ
FEATURES / CARACTERÍSTICAS: grey color
TERMINALS / TERMINALES: 2 terminals
SNAIL / CARACOL: Ø96mm
APPLICATION / APLICACIÓN: MB: Sprinter 311 2002>2011, Sprinter 313 2002>2011, Sprinter 413 2002>2011

GB1060
12V

CURRENT / CONDUCTA: 4A
SOUND POWER / POTENCIA DE SONIDO: 110 ± 5 dB
FREQUENCY / FRECUENCIA: HT: 420±20HZ / LT: 350±20HZ
FEATURES / CARACTERÍSTICAS: black color, with support, high and low tone
TERMINALS / TERMINALES: 2 terminals
DISC / DISCO: Ø92mm
APPLICATION / APLICACIÓN: Universal - vehicles

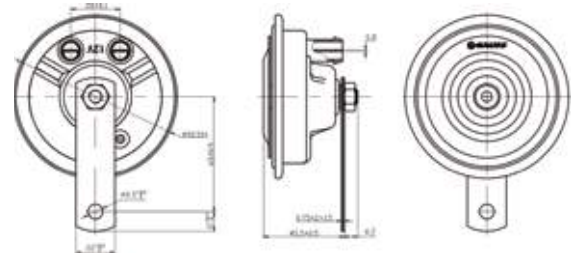
GB1061
12V

CURRENT / CONDUCTA: 4A
SOUND POWER / POTENCIA DE SONIDO: 110 ± 5 dB
FREQUENCY / FRECUENCIA: HT: 420±20HZ
FEATURES / CARACTERÍSTICAS: black color, with support
TERMINALS / TERMINALES: 2 terminals
DISC / DISCO: Ø92mm
APPLICATION / APLICACIÓN: Universal - vehicles

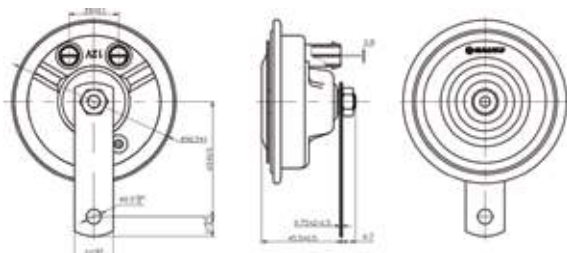

GB1062
12V

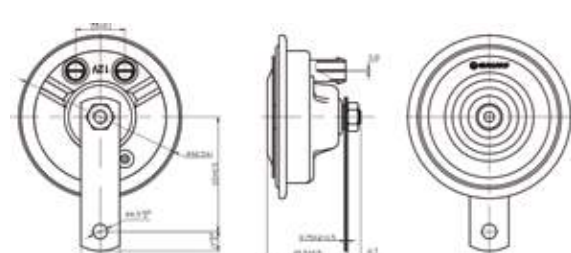
CURRENT / CONDUCTA: 4A
SOUND POWER / POTENCIA DE SONIDO: 110 ± 5 dB
FREQUENCY / FRECUENCIA: LT: 350±20HZ
FEATURES / CARACTERÍSTICAS: black color, with support
TERMINALS / TERMINALES: 2 terminals
DISC / DISCO: Ø92mm
APPLICATION / APLICACIÓN: Universal - vehicles

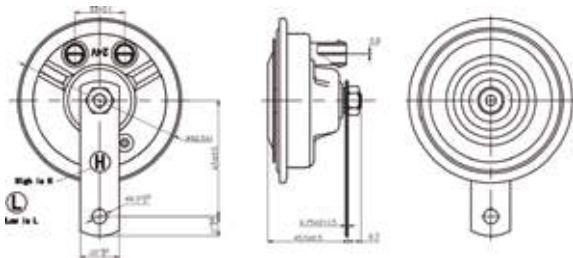

GB1063
24V

CURRENT / CONDUCTA: 4A
 SOUND POWER / POTENCIA DE SONIDO: 110 ± 5 dB
 FREQUENCY / FRECUENCIA: HT: 420±20HZ / LT: 350±20HZ
 FEATURES / CARACTERÍSTICAS: black color, with support, high and low tone
 TERMINALS / TERMINALES: 2 terminals
 DISC / DISCO: Ø92mm
 APPLICATION / APLICACIÓN: Universal - vehicles

GB1064
12V

CURRENT / CONDUCTA: 6A
 SOUND POWER / POTENCIA DE SONIDO: 115 ± 5 dB
 FREQUENCY / FRECUENCIA: LT: 335±20HZ
 FEATURES / CARACTERÍSTICAS: grey color, with support, Mercedes sound
 TERMINALS / TERMINALES: 2 terminals
 DISC / DISCO: Ø125mm
 APPLICATION / APLICACIÓN: Universal - vehicles

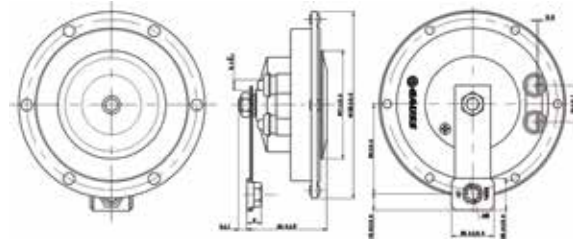
GB1065
24V

CURRENT / CONDUCTA: 6A
 SOUND POWER / POTENCIA DE SONIDO: 115 ± 5 dB
 FREQUENCY / FRECUENCIA: LT: 335±20HZ
 FEATURES / CARACTERÍSTICAS: grey color, with support, Mercedes sound
 TERMINALS / TERMINALES: 2 terminals
 DISC / DISCO: Ø125mm
 APPLICATION / APLICACIÓN: Universal - vehicles

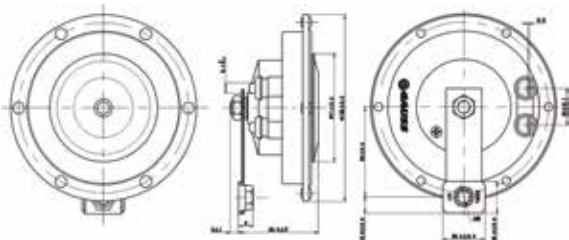

GB1066
12V

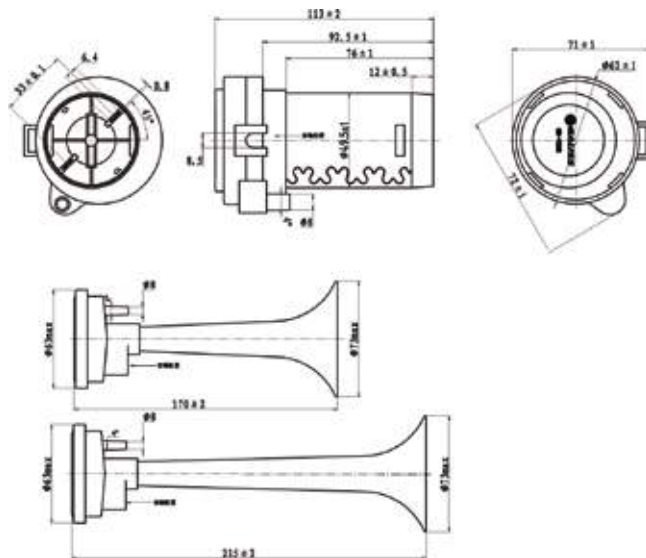
CURRENT / CONDUCTA: 20A
 SOUND POWER / POTENCIA DE SONIDO: ≥110dB
 FREQUENCY / FRECUENCIA: 530 / 680HZ
 FEATURES / CARACTERÍSTICAS: electric air horn, red color, with compresor, with installation KIT + Relay
 HORN / ALARMA: 165 / 215mm
 APPLICATION / APLICACIÓN: Universal - vehicles

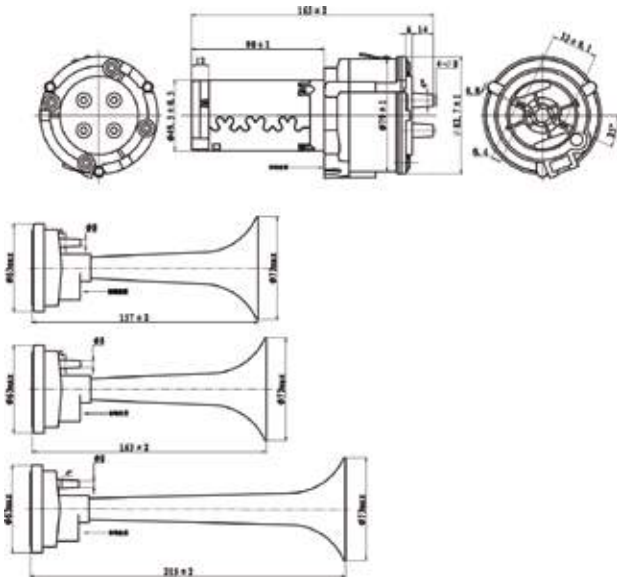

GB1067
12V

CURRENT / CONDUCTA: 20A
SOUND POWER / POTENCIA DE SONIDO: ≥ 110 dB
FREQUENCY / FRECUENCIA: 530 / 680 / 830HZ
FEATURES / CARACTERÍSTICAS: electric air horn, red color, with compressor, with installation KIT + Relay
HORN / ALARMA: 153 / 165 / 215mm
APPLICATION / APLICACIÓN: Universal - vehicles

GB1068
12V

CURRENT / CONDUCTA: 4A
SOUND POWER / POTENCIA DE SONIDO: ≥ 110 dB
FREQUENCY / FRECUENCIA: 450HZ
FEATURES / CARACTERÍSTICAS: electric air horn, black color, with valve
HORN / ALARMA: 165 / 215mm
APPLICATION / APLICACIÓN: Universal - trucks and buses

GB1069
24V

CURRENT / CONDUCTA: 4A
SOUND POWER / POTENCIA DE SONIDO: ≥ 110 dB
FREQUENCY / FRECUENCIA: 450HZ
FEATURES / CARACTERÍSTICAS: electric air horn, black color, with valve
HORN / ALARMA: 165 / 215mm
APPLICATION / APLICACIÓN: Universal - trucks and buses

GB1070
12V

CURRENT / CONDUCTA: 4.5A
SOUND POWER / POTENCIA DE SONIDO: 110 ± 5 dB
FREQUENCY / FRECUENCIA: HT:500±20HZ
FEATURES / CARACTERÍSTICAS: black color
SNAIL / CARACOL: Ø95mm
APPLICATION / APLICACIÓN: Universal

GB1071
12V

CURRENT / CONDUCTA: 4.5A
SOUND POWER / POTENCIA DE SONIDO: 110 ± 5 dB
FREQUENCY / FRECUENCIA: LT:400±20HZ
FEATURES / CARACTERÍSTICAS: black color
SNAIL / CARACOL: Ø95mm
APPLICATION / APLICACIÓN: Universal

GB1072
12V

CURRENT / CONDUCTA: 4.5A
SOUND POWER / POTENCIA DE SONIDO: 110 ± 5 dB
FREQUENCY / FRECUENCIA: HT:500±20HZ / L:400±20HZ
FEATURES / CARACTERÍSTICAS: black color
SNAIL / CARACOL: Ø95mm
APPLICATION / APLICACIÓN: Universal

GB1073

SOUND POWER / POTENCIA DE SONIDO: ≥ 110 DB
FREQUENCY / FRECUENCIA: 530/ 680/ 830HZ
FEATURES / CARACTERÍSTICAS: 3 horn (153mm, 165mm, 215mm), without valve, plastic, red color, with installation KIT
APPLICATION / APLICACIÓN: Universal

GB1074
12V

CURRENT / CONDUCTA: $\leq 20A$
SOUND POWER / POTENCIA DE SONIDO: $\geq 115DB$
FREQUENCY / FRECUENCIA: 530/ 680HZ
FEATURES / CARACTERÍSTICAS: 1 horn, with compresor, plastic, red color, with installation KIT + Relay
APPLICATION / APLICACIÓN: Universal

GB1075
12V

CURRENT / CONDUCTA: $\leq 20A$
SOUND POWER / POTENCIA DE SONIDO: $\geq 110DB$
FREQUENCY / FRECUENCIA: 530/ 680/ 760/ 830HZ
FEATURES / CARACTERÍSTICAS: 6 horn, with compresor, plastic, red color, with installation KIT + Relay
APPLICATION / APLICACIÓN: Universal

GB1076
24V

CURRENT / CONDUCTA: $\leq 20A$
SOUND POWER / POTENCIA DE SONIDO: $\geq 110DB$
FREQUENCY / FRECUENCIA: 530/ 680/ 760/ 830HZ
FEATURES / CARACTERÍSTICAS: 6 horn, with compresor, plastic, red color, with installation KIT + Relay
APPLICATION / APLICACIÓN: Universal

GB1077
24V

CURRENT / CONDUCTA: $\leq 20A$
SOUND POWER / POTENCIA DE SONIDO: $\geq 110DB$
FREQUENCY / FRECUENCIA: 530/ 680HZ
FEATURES / CARACTERÍSTICAS: 2 horn (165mm, 215mm), with compresor, plastic, red color, with installation KIT + Relay
APPLICATION / APLICACIÓN: Universal

GB1080
12V

CURRENT / CONDUCTA: 4A
SOUND POWER / POTENCIA DE SONIDO: 110 ± 5 dB
FREQUENCY / FRECUENCIA: HT:400 \pm 20HZ
FEATURES / CARACTERÍSTICAS: black color
DISC / DISCO: $\varnothing 125$ mm
APPLICATION / APLICACIÓN: Universal

GB1081
12V

CURRENT / CONDUCTA: 4A
SOUND POWER / POTENCIA DE SONIDO: 110 ± 5 dB
FREQUENCY / FRECUENCIA: LT:335 \pm 20HZ
FEATURES / CARACTERÍSTICAS: black color
DISC / DISCO: $\varnothing 125$ mm
APPLICATION / APLICACIÓN: Universal

GB1082
12V

CURRENT / CONDUCTA: 4A
SOUND POWER / POTENCIA DE SONIDO: 110 ± 5 dB
FREQUENCY / FRECUENCIA: HT:400 \pm 20HZ / LT:335 \pm 20HZ
FEATURES / CARACTERÍSTICAS: black color
DISC / DISCO: $\varnothing 125$ mm
APPLICATION / APLICACIÓN: Universal

GB1084
12V

CURRENT / CONDUCTA: 4A
SOUND POWER / POTENCIA DE SONIDO: 110dB
FREQUENCY / FRECUENCIA: HT:400 \pm 20HZ / LT:335 \pm 20HZ
FEATURES / CARACTERÍSTICAS: grey color
DISC / DISCO: $\varnothing 97$ mm
APPLICATION / APLICACIÓN: Universal
REPLACES / REEMPLAZA: HELLA: 3AL 002 952-891

GB1085
12V

CURRENT / CONDUCTA: 4A
SOUND POWER / POTENCIA DE SONIDO: 110dB
FREQUENCY / FRECUENCIA: HT:400 \pm 20HZ
FEATURES / CARACTERÍSTICAS: grey color
DISC / DISCO: $\varnothing 97$ mm
Application / APLICACIÓN: Universal

GB1101
12V

PRESSURE / PRESIÓN: 0,3 ~ 1,0 MPA
FEATURES / CARACTERÍSTICAS: aluminium color, compresor for air horn
APPLICATION / APLICACIÓN: Universal

GB1102
24V

PRESSURE / PRESIÓN: 0,3 ~ 1,0 Mpa
FEATURES / CARACTERÍSTICAS: aluminium color, compresor for air horn
APPLICATION / APLICACIÓN: Universal

GB1103
12V - 4A

FEATURES / CARACTERÍSTICAS: electric valve for the compressed air horn
DIAMETER / DIÁMETRO: 32mm
APPLICATION / APLICACIÓN: Universal

GB1104
24V - 4A

FEATURES / CARACTERÍSTICAS: electric valve for the compressed air horn
DIAMETER / DIÁMETRO: 32mm
APPLICATION / APLICACIÓN: Universal

GB1105
12V - 4A

FEATURES / CARACTERÍSTICAS: electric valve for the compressed air horn
APPLICATION / APLICACIÓN: Universal

GB1106
24V - 4A

FEATURES / CARACTERÍSTICAS: electric valve for the compressed air horn
APPLICATION / APLICACIÓN: Universal

GB1107
12V - 4A

FEATURES / CARACTERÍSTICAS: electric valve for the compressed air horn
APPLICATION / APLICACIÓN: Universal

GB1108
24V - 4A

FEATURES / CARACTERÍSTICAS: electric valve for the compressed air horn
DIAMETER / DIÁMETRO: 32mm
APPLICATION / APLICACIÓN: Universal

GB2085
12V ~ 24V (Bivolt)

SOUND POWER / POTENCIA DE SONIDO: ≥ 85 dB
FEATURES / CARACTERÍSTICAS: back-up alarm, black color
APPLICATION / APLICACIÓN: Universal - vehicles

GB2087
12V ~ 36V (Bivolt)

SOUND POWER / POTENCIA DE SONIDO: ≥ 107 dB
FEATURES / CARACTERÍSTICAS: back-up alarm, black color
APPLICATION / APLICACIÓN: Universal - vehicles

GB2088
12V

CURRENT / CONDUCTA: 0.1A
SOUND POWER / POTENCIA DE SONIDO: ≥ 90 dB
FREQUENCY / FRECUENCIA: 250Hz
FEATURES / CARACTERÍSTICAS: intermittent sound / reduced size

GB2089
24V

CURRENT / CONDUCTA: 0.2A
SOUND POWER / POTENCIA DE SONIDO: ≥ 100 dB
FREQUENCY / FRECUENCIA: 250Hz
FEATURES / CARACTERÍSTICAS: intermittent sound / reduced size

GB2090
12V ~ 36V (Bivolt)

CURRENT / CONDUCTA: 1.2A
SOUND POWER / POTENCIA DE SONIDO: ≥ 97 dB
FEATURES / CARACTERÍSTICAS: back-up alarm, black color
APPLICATION / APLICACIÓN: Ideal for trucks and tractors types / Ideal para todo tipos de camiones y tractores.

GB2091
12V ~ 36V (Bivolt)

SOUND POWER / POTENCIA DE SONIDO: ≥ 112 dB
FEATURES / CARACTERÍSTICAS: back-up alarm, black color
APPLICATION / APLICACIÓN: Universal - vehicles

GB2092
12V ~ 24V (Bivolt)

SOUND POWER / POTENCIA DE SONIDO: day: ≥ 110 dB (A) / night: ≥ 85 dB (A)
FEATURES / CARACTERÍSTICAS: back-up alarm, black color, Intermittent sound / 2 intensities
APPLICATION / APLICACIÓN: Universal - vehicles

GB2093
12V ~ 36V (Bivolt)

FEATURES / CARACTERÍSTICAS: With three sound levels by manual adjust: 112dB high | 107dB medium | 97dB low
APPLICATION / APLICACIÓN: For heavy duty commercial vehicles (trucks and tractors)

GB3000
12V ~ 24V (Bivolt) // NEW //

CURRENT / CONDUCTA: 0.4A
SOUND POWER / POTENCIA DE SONIDO: ≥ 120 dB / 3dB
FREQUENCY / FRECUENCIA: 140Hz
FEATURES / CARACTERÍSTICAS: electronic siren, black color
APPLICATION / APLICACIÓN: Universal - vehicles



GB3001

12V

SOUND POWER / POTENCIA DE SONIDO: $\geq 119\text{dB}$ / 30W
FEATURES / CARACTERÍSTICAS: electronic siren, black color, 6 tones
APPLICATION / APLICACIÓN: Universal - vehicles



GB3003

12V // NEW //

CURRENT / CONDUCTA: 0.7A
SOUND POWER / POTENCIA DE SONIDO: $\geq 105\text{dB}$ / 3dB
FEATURES / CARACTERÍSTICAS: electronic siren, black color, 3 tones
APPLICATION / APLICACIÓN: Universal - vehicles



GB3007

12V // NEW //

FEATURES / CARACTERÍSTICAS: electronic siren, black color, 7 tones, MIC PA SPEAKER SYSTEM
APPLICATION / APLICACIÓN: Universal - vehicles



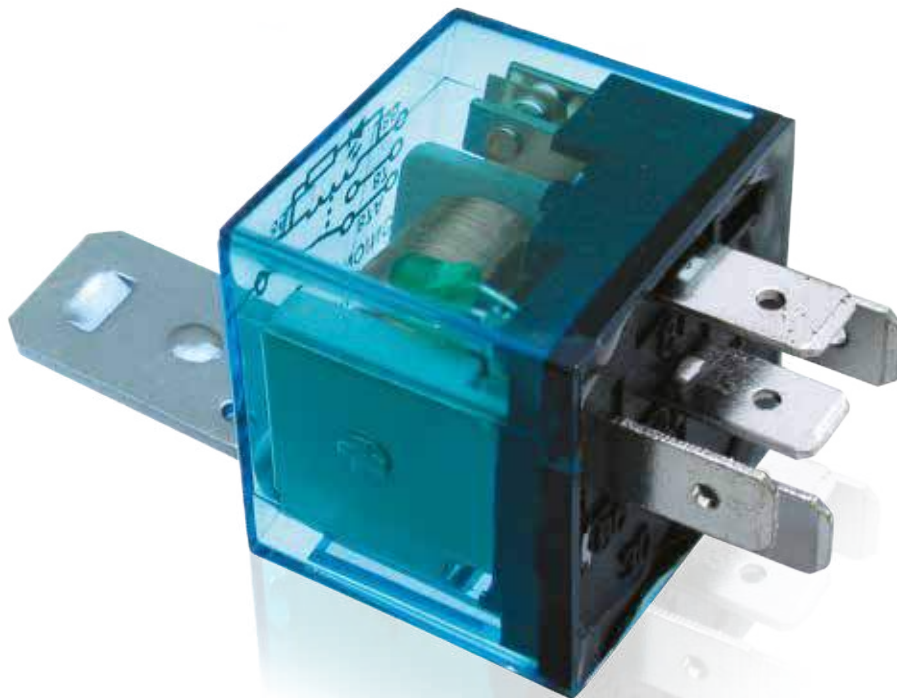

ELECTRICAL SPARE PART | PIEZA ELÉCTRICA

RELAY | RELÉ

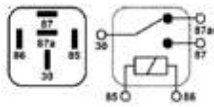
GE0001

FEATURES / CARACTERÍSTICAS: 40/40A, 12V - 5 terminals / with bracket - AUXILIARY RELAY

REPLACES / REEMPLAZA:

Renault: 7702072115, 7702218610; **GM:** 94606308, 04243779; **MMB:** 3445527119, 6645427119; **CITROËN/PEUGEOT:** 7905522200, 6455-000; **FORD:** 78AU15040A, 6885427619, EZHT4A156BA; **MARCOPOLO:** 102016755; **VW:** 4143779, 32599112641; **VDO:** D-09339; **FIAT:** 7619302, 7686774

APPLICATION / APLICACIÓN:

RENAULT: Traffic, Twingo, Express, Clio, R9, R11, R12, R18, R19, R21, R25, R30;

GM: Opala, Caravan;

MMB: Trucks;

PEUGEOT: 205/306/405;

CITROËN: Xantia, Xsara;

FORD: Galaxie;

MARCOPOLO: Buses;

FIAT: Ducato, Tempra, Uno, Prêmio

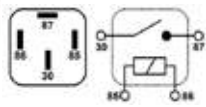
GE0002

FEATURES / CARACTERÍSTICAS: 40A, 12V - 4 terminals / with bracket - AUXILIARY RELAY

REPLACES / REEMPLAZA:

VW: 305 919 505, 1 305 919 505, 2 305 951 251, 305 951 251 1, 505 951 251, 542 937 503, 547 937 503 E, T00 941 589, T11 941 589, T1G 941 589, ZBA 915 505, ZBA 919 505 A, ZBA 941 587, ZBA 951 251, ZBC 919 505, ZBC 937 503, ZBC 937 503 A; **FORD:** 542 937 503, 78MU018C641A, 79MU13842A, 81AG 14N089AA, 81AG 14N089CA, 85AU 14N089CA, 86AU 18C641CA, 86TU 13842AA, 86TU 14N089A, 86TU 14089AA, 87EU 18C641AA, T00 941589, T1G 941589, ZBC 937 503; **GM:** 90 376 920, 94 607 594, 94 626 862, 94 651 542; **VDO:** D-09520

APPLICATION / APLICACIÓN:

Vehicles: Ford, Fiat, Peugeot, GM, VW

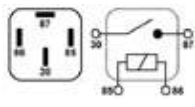
GE0003

FEATURES / CARACTERÍSTICAS: 40A, 24V - 4 terminals / with bracket - AUXILIARY RELAY

REPLACES / REEMPLAZA:

SCANIA: 228600, 235940, 243462; **VOLVO:** 1 504 951; **MARCOPOLO:** 1420 1602 1; **VDO:** D-00208

APPLICATION / APLICACIÓN:

SCANIA: Trucks / Buses 75->

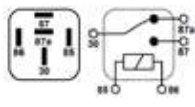
GE0004

FEATURES / CARACTERÍSTICAS: 10/20A, 24V - 5 terminals / with bracket - AUXILIARY RELAY

REPLACES / REEMPLAZA:

SCANIA: 23460, 539509; **VOLVO:** 837878, 1504957, 4786690; **MMB:** 3505427019, 3505427119, 3505427719, 3865427719; **INDUSCAR:** 42004121, 42004068; **VDO:** D-09309

APPLICATION / APLICACIÓN:

Trucks, Buses Scania, Volvo, VW

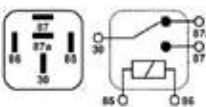
GE0005

FEATURES / CARACTERÍSTICAS: 35A, 12V - 5 terminals - AUXILIARY RELAY

REPLACES / REEMPLAZA:

Ford: F65B-13350-AA; **Airtex:** 1R2198; **Wells:** FLA119

APPLICATION / APLICACIÓN:

FORD; LINCOLN; MERCURY

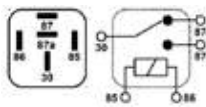
GE0006

FEATURES / CARACTERÍSTICAS: 35A - 24V - 5 terminals - AUXILIARY RELAY

REPLACES / REEMPLAZA:

APPLICATION / APLICACIÓN:

Automotive

GE0007

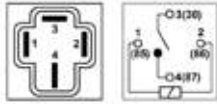

FEATURES / CARACTERÍSTICAS: 30A - 12V - 4 terminals - Dimmer relay

REPLACES / REEMPLAZA:

90987-87017, 90987-02009, 15606-0060

APPLICATION / APLICACIÓN:

TOYOTA

GE0008



FEATURES / CARACTERÍSTICAS: 30A - 12V - 4 terminals - Head Light Relay

REPLACES / REEMPLAZA:

Honda: 88263-14100

APPLICATION / APLICACIÓN:

TOYOTA: Corolla 98-02; HONDA: Civic

GE0009

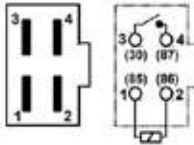

FEATURES / CARACTERÍSTICAS: 30A - 12V - 4 terminals - Dimmer relay

REPLACES / REEMPLAZA:

28300-16100, 85926-30020, 90987-87017, 90987-03003, 056700-5081

APPLICATION / APLICACIÓN:

TOYOTA

GE0010

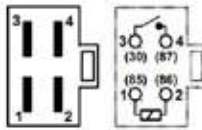

FEATURES / CARACTERÍSTICAS: 20A - 12V - 4 terminals

REPLACES / REEMPLAZA:

HONDA: 56700-7250, 39400-SEO-003; MITSUBISHI: MB183863; HYUNDAI: 95220-000, 95220 - 100

APPLICATION / APLICACIÓN:

HONDA: Civic; MITSUBISHI: L200; SUZUKI: Swift

GE0011

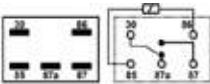

FEATURES / CARACTERÍSTICAS: 25A NO / 20A NC - 12V - 5 terminals - Auxiliar relay

REPLACES / REEMPLAZA:

12077865, 12088576, 12088506, 12193602, 12135175, 12135170, 12135180, 12360348, 12077866

APPLICATION / APLICACIÓN:

GM: S10, Blazer V6, Silverado; 13500 128

GE0012

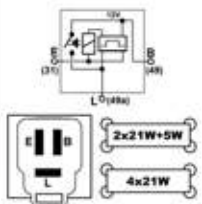

FEATURES / CARACTERÍSTICAS: 12V - 3 PINS - 2(4)x21W-23W±10W - FLASHER RELAY

REPLACES / REEMPLAZA:

3211-138-320, 3211-156-320

APPLICATION / APLICACIÓN:

MAZDA

GE0013 // NEW //

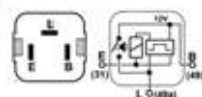

FEATURES / CARACTERÍSTICAS: FLASHER RELAY - 3 terminals, with support - 12V

REPLACES / REEMPLAZA:

Hyundai/ Kia: 95550-2E100, 9555039000

Mitsubishi: 302374

APPLICATION / APLICACIÓN:

HYUNDAI: Accent, Scoupe, Sonata 1995>2005, Elantra 1995>2010, Santa Fé 2001>2006, Tiburon 1997>2001

KIA: Optima 2001>2005, Rio 2006>2010

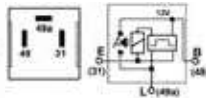
GE0014

FEATURES / CARACTERÍSTICAS: 12V - 3 PINS - 2(4)x21W-23W±10W - FLASHER RELAY

REPLACES / REEMPLAZA:

81980-A1705, 8-97086509-1, 8-97105453-0, 166500-0561, 066500-0561, 86660-87701, 81980-8770

APPLICATION / APLICACIÓN:

For European Vehicles / DAIHATSU ISUZU

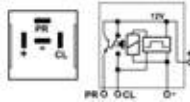
GE0015 // NEW //

FEATURES / CARACTERÍSTICAS: FLASHER RELAY - 4 terminals - 12V

REPLACES / REEMPLAZA:

ALFA ROMEO: 5942627, 7595406; **FIAT:** 5942627, 7595406; **LANCIA:** 5942627, 7595406; **RENAULT:** 77 00 738 864;

STILL: 0009732509;

APPLICATION / APLICACIÓN:

ALFA ROMEO: 164 1987>1998;

CITROEN: AX 1986>1998, BX 1982>1994, BX Break 1983>1994;

FIAT: Cinquecento 1991>1999, Ducato 1989>1994, Fiorino 1977>1993, Fiorino Caixa 1988->, Fiorino Pick Up 1977>2001, Panda 1980>2004, Panda Van 1986->, Talento Autocarro 1989>1994, Talento Caixa 1989>1994, Talento Caminhão de plataforma 1989>1994;

LANCIA: Delta 1979>1994, Y10 1985>1995;

PEUGEOT: 205 Diesel 1994->, 205 1983>1990, 205 I 1883>1987, 205 I Cabriolet 1986>1995, 205 II 1987>1998, 309 I 1985>1989, 309 II 1989>1993;

RENAULT: 4 1962>1993, 5 1972>85, 6 1969>1987, 9 1981>1997, 11 1983>1995, 18 1978>1994, 18 Variable 1979>1994, 19 I 1988>1994, 19 I Cabriolet 1991>1992, 19 I Chamade 1988>1992, 19 II 1991>2001, 19 II Cabriolet 1992>2001, 19 II Caixa 1992>1995, 19 II Chamade 1992>2003, 21 1989>1994, 21 Combi 1986>1997, 25 1984>1993, 30 1975>1986, Clio I 1990>1998, Espace I 1984>1992, Espace II 1991>1997, Laguna I 1993>2002, Laguna I Grandtour 1995>2002, Rapid Caixa 1985>2001, Super 5 1984>1996, Super 5 Caixa 1984>1996, Twingo 1993->;

SEAT: Ibiza I 1984>1993, Malaga 1984>1993, Marbella 1986>1998, Marbella Caixa 1986>1993

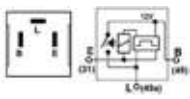
GE0016 // NEW //

FEATURES / CARACTERÍSTICAS: 3 terminals - 12V

REPLACES / REEMPLAZA:

DAIHATSU: 81980-87705-000, 166500-0110

APPLICATION / APLICACIÓN:

For Korean Vehicle

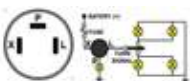
GE0017

FEATURES / CARACTERÍSTICAS: 12V - 3 PINS - 20A - 240W

APPLICATION / APLICACIÓN:

Universal

GE0018



FEATURES / CARACTERÍSTICAS: 12V - 2 PINS - Universal - FLASHER RELAY

REPLACES / REEMPLAZA:

Universal

APPLICATION / APLICACIÓN:

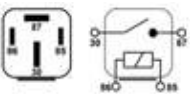
Universal

GE0019

FEATURES / CARACTERÍSTICAS: 12V - 4 PINS - 80A

APPLICATION / APLICACIÓN:

Universal

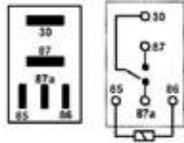
GE0020

FEATURES / CARACTERÍSTICAS: 30A | 24V - 5 PINS - Universal - MINI-RELAY AUXILIARY

REPLACES / REEMPLAZA: 3845427119

APPLICATION / APLICACIÓN:
General use - 24V

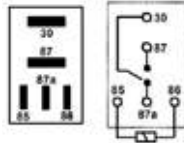
GE0021

FEATURES / CARACTERÍSTICAS: 30A | 12V - 5 PINS - Universal - MINI-RELAY AUXILIARY

REPLACES / REEMPLAZA:

APPLICATION / APLICACIÓN:
General use - 12V

GE0022

FEATURES / CARACTERÍSTICAS: 22A | 12V 4 TERMINALS - MINI-RELAY AUXILIARY, without support

REPLACES / REEMPLAZA:

Toyota: 9098702004, 056700-4810

APPLICATION / APLICACIÓN:
MITSUBISHI: Pajero 93>99, L-200

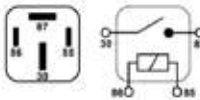
GE0023

FEATURES / CARACTERÍSTICAS: 70A | 12V - 4 TERMINALS - INJECTION RELAY, without support

REPLACES / REEMPLAZA:

GM: 1238612, 90226846;

FORD: 93BG14N089CA, 93BG14N089CB;

HYUNDAI / KIA: 39160-37110, 95210-2E000;

TOYOTA: 90987-T2002

APPLICATION / APLICACIÓN:
GM: Corsa (All), Astra, Vectra

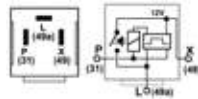
GE0024 // NEW //

FEATURES / CARACTERÍSTICAS: FLASHER RELAY, 3 TERMINALS - 12V, with support

REPLACES / REEMPLAZA:

FORD: 81TU13350AA, 87TU13350AA, TJG953227; **AGCO:** 850000000133; **BUSSCAR:** 1377612; **NIELSON:** 1377612

APPLICATION / APLICACIÓN:

FORD: Cargo (all);

HYSTER: Forklifts (all)

NIELSON: Bus

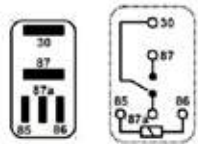
GE0025

FEATURES / CARACTERÍSTICAS: 30/ 20A | 12V - 5 TERMINALS - MINI AUXILIARY RELAY, without support

REPLACES / REEMPLAZA:

Mercedes Benz: 3825450105, 0035420219, 004545290

APPLICATION / APLICACIÓN:

MERCEDES BENZ: Sprinter Minibus, Flatbed, Dumptruck, Vito Van, Minibus, Box, Mixto, Tourer, SL Class, M-Class, GL-Class, V-Class

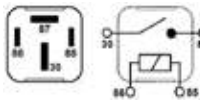
GE0026

FEATURES / CARACTERÍSTICAS: 50A | 24V - 4 TERMINALS - AUXILIARY RELAY, without support

REPLACES / REEMPLAZA:

SCANIA: 303535, 1439172

APPLICATION / APLICACIÓN:

SCANIA: Trucks and Bus 75>

GE0027 // NEW //

FEATURES / CARACTERÍSTICAS: 720W | 12V - 4 PIN - FLASHER RELAY

REPLACES / REEMPLAZA:

...

APPLICATION / APLICACIÓN:
FIAT / MBB / AGCO / BUSSCAR / CAIO / INDUSCAR / MARCOPOLO / CIFERAL / COMIL / NIELSON / UNIVERSAL: Truck and Bus

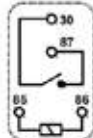
GE0028

FEATURES / CARACTERÍSTICAS: 30A | 12V - 4 TERMINALS - MINI AUXILIARY/ INJECTION RELAY, without support

2x2,8mm + 2x6mm

REPLACES / REEMPLAZA:
FIAT: 7525171;

VW: 542937503D;

FORD: 86AG14N089AA, 86AG7K057AA, 86AU14N89A, 96FG14N089AA, 98FU14N089BA;

GM: 24433728, 93238065, 52288733;

NEW HOLLAND: 83990086

APPLICATION / APLICACIÓN:
FIAT: Uno, Tempra, Elba;

VW: Pointer, Gol, Santana, Logus, Saveiro;

FORD: Del Rey, Escort, Verona, Fiesta (All);

GM: Corsa (All), Ipanema, S10, Monza, Kadett, Ómega, Vectra

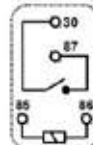
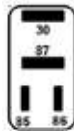
GE0029

FEATURES / CARACTERÍSTICAS: 30A | 12V - 4 TERMINALS - MINI AUXILIARY RELAY, without support

2x4,5mm + 2x6mm

REPLACES / REEMPLAZA:
GM: 1238505, 24433728, 60229206, 6238541, 90229206, 90508807, 93209737, 93209739, 93226612, 93224503;

HYUNDAI / KIA: 95224-20000, 95224-29850, 95224-3E500, 95230-2P020;

FIAT: 46520412, 46520421, 7676504;

TOYOTA: 9008087021;

mitsubishi: MB629083, MB629085

APPLICATION / APLICACIÓN:
GM: Corsa, Vectra, Ómega 96>;

VW: Gol, Saveiro, Santana 96>;

FIAT: Uno, Siena, Marea, Brava, Tempra, Palio 96>;

TOYOTA: Yaris, Aygo

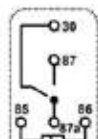
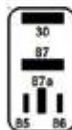
GE0030

FEATURES / CARACTERÍSTICAS: 30/20A | 12V - 5 TERMINALS - MINI AUXILIARY RELAY, without support

2x4,5mm + 2x6mm

REPLACES / REEMPLAZA:
GM: 52255944;

FIAT: 46520423

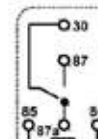
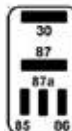
APPLICATION / APLICACIÓN:
GM: Corsa, Ómega, Monza, Kadett 92, Ipanema, Vectra

GE0031

FEATURES / CARACTERÍSTICAS: 30/20A | 12V - 5 TERMINALS - MINI AUXILIARY RELAY, without support

REPLACES / REEMPLAZA:
MERCEDES BENZ: 3845427319, 0025421219; **PEUGEOT:** 9620220980;

RENAULT: 7700414484, 962220980; **VW:** 4H0951253C, 7M0951253C;

FIAT: 46453554, 46520423; **FORD:** F57B14B192AA; **CITROËN:** 9620220980;

IVECO: 465204130, 504049024; **JAC MOTORS:** 3735906U1010;

JOHN DEERE: AL-76702; **MITSUBISHI:** MK387785;

GM: 1238967, 6238527, 6238623, 90414477, 90511443, 93172269;

TOYOTA: 88263-32070, 90080-87020, 90084-98032, 90987-04004;

HYUNDAI/KIA: 95225-2D000, 95225-2E300, 95225-29050, 95225-3B500

APPLICATION / APLICACIÓN:
PEUGEOT: 306;

RENAULT: Clio, Scénic, Mégane;

FIAT: Marea, Brava;

FORD: F-250;

CITROËN: Xsara;

JAC MOTORS: J3, Turin;

GM: Corsa

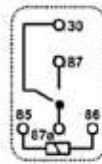
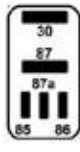
GE0032

FEATURES / CARACTERÍSTICAS: 30/20A | 24V - 5 TERMINALS - MINI AUXILIARY RELAY, without support

REPLACES / REEMPLAZA:

FORD: 6C4514B192-AA;

DAF: 1301879, 1448174;

MERCEDES BENZ: 0025422719, 0025423019, 3845427119, 7375181000;

IVECO: 98444017;

SCANIA / VOLVO: 1320483, 3093031

APPLICATION / APLICACIÓN:

MERCEDES BENZ: Atego, Axor, O-500, OF, OH

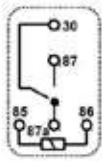
GE0033

FEATURES / CARACTERÍSTICAS: 20/10A | 24V - 5 TERMINALS - MINI AUXILIARY RELAY, without support, for vehicles with electronic modules

REPLACES / REEMPLAZA:

MERCEDES BENZ: 0025422719, 0025423019, 0045453505, 7375181000;

HYUNDAI/KIA: 95224-7A000;

SCANIA: 1320483;

VOLVO: 3093031

APPLICATION / APLICACIÓN:

MERCEDES BENZ: Actor, Atego, Axor, O-500, OF, OH

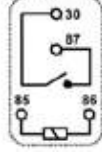
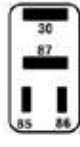
GE0034

FEATURES / CARACTERÍSTICAS: 30A | 24V - 4 TERMINALS - MINI AUXILIARY RELAY, without support,

2x4,5mm + 2x6,3mm

REPLACES / REEMPLAZA:

VW: 2R295529.1, 2R2955229.1

APPLICATION / APLICACIÓN:

VW: Trucks and Bus

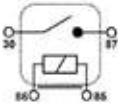
GE0035

FEATURES / CARACTERÍSTICAS: 50A | 24V - 4 TERMINALS - UNIVERSAL AUXILIARY RELAY, with support

REPLACES / REEMPLAZA:

MERCEDES BENZ: 3645427319;

SCANIA: 303535

APPLICATION / APLICACIÓN:

MERCEDES BENZ: Trucks and Bus

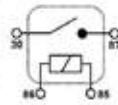
GE0036

FEATURES / CARACTERÍSTICAS: 70A | 12V - 4 TERMINALS - AUXILIARY RELAY, without support

REPLACES / REEMPLAZA:

Fiat: 7606542, 7752313, 46520429, 42520429

APPLICATION / APLICACIÓN:

FIAT: Palio, Siena Weekend, Tempra, Strada, Uno, Alfa Romeo, Marea, Brava Weekend

GE0037 // NEW //



FEATURES / CARACTERÍSTICAS: 12V - 6 PIN - INTERNAL LIGHT RELAY, without support

REPLACES / REEMPLAZA:

FIAT: 7734971

APPLICATION / APLICACIÓN:

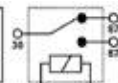
FIAT: All Vehicles

GE0038

FEATURES / CARACTERÍSTICAS: 50/ 30A | 24V - 5 TERMINALS - UNIVERSAL AUXILIARY RELAY, removable bracket

REPLACES / REEMPLAZA:

CATERPILLAR: 7Y-5490; **IRIZAR:** 539538

APPLICATION / APLICACIÓN:

Ideal for agricultural machines, general use

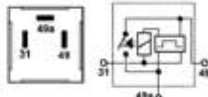
GE0039

FEATURES / CARACTERÍSTICAS: 12V - 3 TERMINALS - FLASHER RELAY, without support

REPLACES / REEMPLAZA:

FORD: 111953227D, 78G613650AA, ZBC953227

MERCEDES BENZ: 0195450232

GM: 90046088, 93203241, 94614266, 94633792

TOYOTA: 81990474-BO

VW: 111953227.2, 219531831, 2R0953231, 2S0953231, ZBC953227, 305953227.1, 250953231

APPLICATION / APLICACIÓN:

FORD: Escort, Verona

GM: Kadett, Monza, Corsa, Chevette, Ômega, S10, Blazer, Silverado

VW: Gol, Santana, Voyage 1985->, Apollo, Logus, Trucks BMW/ CADILLAC/ NISSAN/ PORSCHE

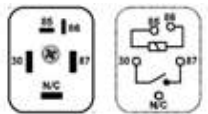
GE0040 // NEW //

FEATURES / CARACTERÍSTICAS: 80A - STARTER RELAY, 5 TERMINALS - 12V

REPLACES / REEMPLAZA:

ISUZU: 8-97173-951-0

APPLICATION / APLICACIÓN:

ISUZU: NPR 1994>2016, NPR-HD 2005>2016 Diesel 4HK1 5.2L, NQR 1994>2016, NRR 2005>2016 Diesel 4HK1 5.2L, REACH 2011>2016 Diesel 4JJ1 3.0L

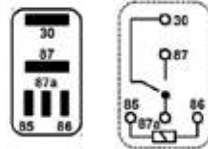
GE0041

FEATURES / CARACTERÍSTICAS: 30/ 20A | 12V - 5 TERMINALS - 2x6,3mm + 3x4,8mm - MINI AUXILIARY RELAY, without support

REPLACES / REEMPLAZA:

Citroën/ Peugeot: 6555HJ, 3620022980;

John Deere: AL76702, AZ61578;

Caterpillar: 3620022980;

GM /Opel/ Vauxhall: 24459504

APPLICATION / APLICACIÓN:

JOHN DEERE: Series 6 6105M, 6125M, 6150M, 6170M, 6170R 2012;

OPEL: Astra F hatch/saloon/estate 1.4/1.6, 1.7D/TD/TDS, 1.8, 2.0 1992>2008, Corsa B hatch /van 1.4i/1.7D 1999>2000, Tigra 1.4/1.6 16V 1994>2000;

MERCEDES: Clk Classe convertible 2003>2010, G-Class 230/250/290 1989>2000, Vito Minibus 113/114 2.0, 2.3 1996>2003

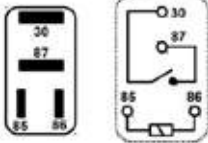
GE0042

FEATURES / CARACTERÍSTICAS: 20A | 12V - 4 TERMINALS - MINI AUXILIARY RELAY, without support

REPLACES / REEMPLAZA:

Toyota: 90987-02022, 156700-2470, 156700-2870, 156700-3290, 90080-87010, 90987-02027, 90987-02028;

Mitsubishi: MR588567

APPLICATION / APLICACIÓN:

TOYOTA: Corolla 1998>2011, Celica 2000>2003;

MITSUBISHI: L200 1998>, Pajero 1998>2007

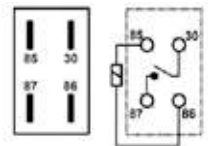
GE0043

FEATURES / CARACTERÍSTICAS: 30A | 12V - 4 TERMINALS - MINI/ AUXILIARY RELAY, without support

REPLACES / REEMPLAZA:

GM: 12135170, 13361776, 13500114, 15393412, 96190187, 12088567, 13502752;

Hyundai/ Kia: 2A267740, 95220-38000, 0K2A267740;

Chrysler: 68083380AA

APPLICATION / APLICACIÓN:

GM: Blazer, Silverado, S-10, Aveo, Spark, Optra, Tahoe 4.8/5.3 V8 1999>2006;

CHRYSLER: ChryslerTown/Country, Dodge Grand Caravan, Jeep Wrangler 2013>2014, Jeep Grand Cherokee, Dodge Durango - 2011>2013, Ram 1500/4500/5500 2011;

HYUNDAI: Sonata MK3 2.0 16V / 2.5 V6 24V 1998>2001;

KIA: Carens MK2 1.8 2002, Carens MK3 2.0 CVVT 2006, 2.0 CRDi 115 2007, Magentis MK2 Saloon 2.0 2005>2008, Menor hatch 1.5i 1996>1997, Shuma MK1 hatch 1.5i/1.8i 16V 1997>2001, Shuma MK1 saloon 1.5 1996>1998, Sportage MK2 2.0i 16V 2004, Sportage MK2 2.0 CRDi

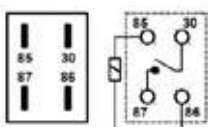
GE0044

FEATURES / CARACTERÍSTICAS: 12V - 4 TERMINALS - MICRO/ AUXILIARY RELAY, without support

REPLACES / REEMPLAZA:

GM: 13500113, 13502753, 13848981, 19116059, 19116962;

Mitsubishi: MR538851;

Navistar: 3600330C1

APPLICATION / APLICACIÓN:

GM: Cobalt, Cruze, Spin, Buick, Cadillac

GE0045



FEATURES / CARACTERÍSTICAS: 12V - 5 TERMINALS - AUXILIARY RELAY, without support

REPLACES / REEMPLAZA:

Mitsubishi: 864906, MC864906

APPLICATION / APLICACIÓN:

General purpose, miscellaneous accessories and forklifts

GE0046

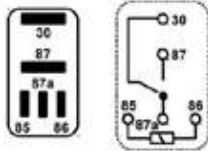

FEATURES / CARACTERÍSTICAS: 24V - 30/ 20A - 5 TERMINALS - 2x6,3mm + 3x4,8mm - MINI AUXILIARY RELAY, without support

REPLACES / REEMPLAZA:

Scania: 1320483;

Volvo: 1078690;

Iveco: 02991715, 2991715, 98444017;

Mercedes Benz: A9585450205, 3845427119;

Renault: 5010589427, 5010645017

APPLICATION / APLICACIÓN:

General purpose, Mercedes-Benz, Renault, Iveco, Daf, Scania, Volvo

GE0047

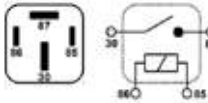

FEATURES / CARACTERÍSTICAS: 24V - 80A - 4 TERMINALS - UNIVERSAL AUXILIARY RELAY, with support

APPLICATION / APLICACIÓN:

General purpose (Ideal for agricultural machines)

GE0048

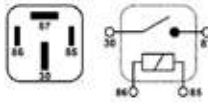

FEATURES / CARACTERÍSTICAS: 12V - 40A - 4 TERMINALS - INJECTION RELAY, without support

REPLACES / REEMPLAZA:

GM/ Opel: 6238514, 6238543, 90357986, 90459642, 90494959, 90949959, 93221424;

VW/ Audi: 171937503, 171937503A, 191937502, 7M0951253B

APPLICATION / APLICACIÓN:

GM: Astra G hatch /saloon/estate/coupe/convertible 1.2/1.4/1.6/1.8/2.0 1998>2005, Omega B Saloon/estate 2.0/2.2 16V/2.5/2.6/3.0/3.2 V6 1994>2003;

VW: Injection valve

GE0049

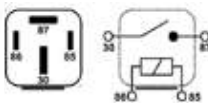

FEATURES / CARACTERÍSTICAS: 12V - 50A - 4 TERMINALS - UNIVERSAL AUXILIARY RELAY, without support

REPLACES / REEMPLAZA:

Massey Ferguson: 053232R1, 05323R1, 32590006;

GM: 94494959

APPLICATION / APLICACIÓN:

General purpose Massey Ferguson, GM

GE0050

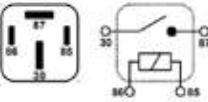

FEATURES / CARACTERÍSTICAS: 12V - 50A - 4 TERMINALS - AUXILIARY/ INJECTION RELAY, without support

REPLACES / REEMPLAZA:

Hyundai/ Kia: 36860-4X000, 39160-37110, 95210-2E000;

Fiat: 46520429, 7606542, 7752313;

VW: 171937503A, 191937503;

GM: 90357986, 90464959, 90494959, 94494959;

Toyota: 90987-T2002

APPLICATION / APLICACIÓN:

HYUNDAI: Tucson;

FIAT: Palio, Alfa 145, Tipo 1.6/2.0, Tempra 1991>;

GM: Astra, Vectra;

VW: Arosa hatch 1.4 TDI 2000>2004, 1.7 SDI 1997>2004

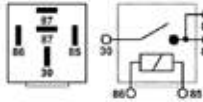
GE0051

FEATURES / CARACTERÍSTICAS: 12V - 2X25A - 5 TERMINALS - AUXILIARY/ INJECTION RELAY, with support

REPLACES / REEMPLAZA:

Fiat: 7615576, 7686773, 94004072, 7619302, 82461739;

VW: KDWHL09663;

Peugeot: 7920048162;

GM: 52251377, 94634568

APPLICATION / APLICACIÓN:

FIAT: Siena, Tempra 91>, Uno, Prêmio, Elba;

PEUGEOT: 205, 405, 505;

GM: Vectra

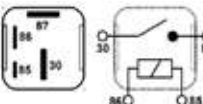
GE0052

FEATURES / CARACTERÍSTICAS: 12V - 40A - 4 TERMINALS - INJECTION RELAY, without support

REPLACES / REEMPLAZA:

Audi/ VW: 171906383, 191906383, 191906383C, 377911253, 6KE906383, 857951253

APPLICATION / APLICACIÓN:

VW: Santana 1.6/1.8/1.6TD 1981>1984, Quantum, Golf, Audi, Passat Alemão, Passat MK2 hatch 1.3/1.6/1.8/2.0/2.2 1979>1989, Passat MK2 saloon 1.6/1.8/2.2 1984>1989, Passat MK2 estate 1.3/1.6/1.8/2.0/2.2 1980>1989, Scirocco MK2 Coupe 1.6/1.8/1.8 16V 1986>1992

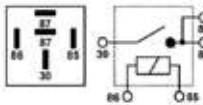
GE0053

FEATURES / CARACTERÍSTICAS: 12V - 2x25A - 5 TERMINALS - AIR CONDITIONING/ INJECTION/AUXILIARY RELAY, without support

REPLACES / REEMPLAZA:

Fiat: 4320625, 4320629, 7619302, 7686773, 46451295, 7686775, 82461739, 94004072, 60812059, 7615576; **Peugeot:** 7920048162;

VW: 701915511; **New Holland:** 5155317; **Hyundai/ Kia:** 39160-3X100; **Bosch:** 0 332 019 150; **Hella:** 4RA933791-121

APPLICATION / APLICACIÓN:

FIAT: Uno, Tipo, Tempra, Fiorino, Elba 92>, Marea, Brava (all), Oggi, 147, Spazio, Premio 77>, Ducato;

PEUGEOT: 205, 206, 405;

HYUNDAI/ KIA: Bongo, Picanto, HR100

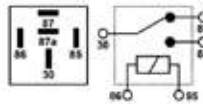
GE0054

FEATURES / CARACTERÍSTICAS: 12V - 40/ 30A - 5 TERMINALS - AUXILIARY/ INJECTION RELAY, without support

REPLACES / REEMPLAZA:

Ford: 325911261.1, 325911261.3, 93BG13AO25AB, 93BG13AO25A1B; **VW:** 325911261.1, 325911261.3, 443951254A, 2PO941595, 2RP951589; **GM:** 120007827, 13306942, 13500119, 6238564, 90191753, 90491314, 90543014, 93203243, 94650999; **Fiat:** 7686774;

Volvo: 8197040012; **Renault:** 20241077, 2339-AA, 0771-BA, 0773-AA, 55160384407, 7702072090, 7702205157; **Hyundai/ Kia:**

39160-3C200, 9522-3B100; **Mercedes Benz:** 45450405, 6885427719, 6885428019; **Citroën:** 6547TX, 655-VPO, 9620725080;

Comil: 02095; **Massey Ferguson:** 6203146M1; **New Holland:** 84997024; **Peugeot:** 6547TX, 7905522200, 9606859880;

Valtra: 6203144M1, 81970400-12; **Iveco:** 48408090, 48495040

APPLICATION / APLICACIÓN:

FORD: Versailles, Royale, Mondeo, Troller;

VW: Santana, Quantum, Gol, Caminhões 11-130, 13-130 1981>;

GM: Astra, Corsa, Meriva, Zafira, Ômega, Tigra, Monza, Ipanema, Kadett EFI 1989>, Vectra 1996>, Celta;

FIAT: Ducato, Tempra, Uno, Brava, Marea (all);

CAIO/ INDUSCAR: Bus;

RENAULT: Mégane, R-9, R-11, R-12, R-18, R-19, R-21, R-25, R-30, Traffic, Clio, Scénic;

KIA: Sportage;

MERCEDES BENZ: Trucks and Bus 1988>;

CITROËN: Berlingo, Xantia, Xsara;

PEUGEOT: 306, 405

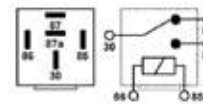
GE0055

FEATURES / CARACTERÍSTICAS: 12V - 40/ 30A - 5 TERMINALS - UNIVERSAL AUXILIARY RELAY, with support

REPLACES / REEMPLAZA:

GM: 04243779, 091144253, 94606308; **VW:** 04243779, 325911264.1, 4143779, 431951253D; **Ford:** 78AU15040A, EZHT4A156BA;

Peugeot: 655588, 7905522200; **Bosch:** 0332204109, 0332204125; **Hella:** 4RD007794021, 4RD007794027, 4RD007794031;

Citroën: 7905522200, 6455-000; **Caio/ Induscar:** 042004140; **Marcopolo:** 10201675.5; **Mascarello:** 3496; **Mercedes Benz:**

3445427119, 6645427119, 6885427619; **Herth+Buss:** 75613197; **Siemens:** V23134-A1052-X294; **Stribel:** 899673000,

899802, 89980200, 899850; **Renault:** 7702072115, 7702218610; **John Deere:** A1150015, 014370, 23030019, 59023; **Neobus:**

20200145; **Chrysler:** 4143779; **Comil:** 02025

APPLICATION / APLICACIÓN:

FGM: Opala, Caravan;

VW: Polara;

FORD: Galaxie, LTD, Landau (all);

PEUGEOT: 205, 306, 405;

CITROËN: Xantia, Xsara, Berlingo, C-15, AX, ZX;

CAIO/ INDUSCAR: Bus;

MARCOPOLO: Bus;

MERCEDES BENZ: Truck (all);

RENAULT: Nevada, R-9/11/12/18/19/21/25/30, Traffic, Clio, Twingo

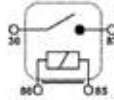
GE0056

FEATURES / CARACTERÍSTICAS: 12V - 60A - 4 TERMINALS - UNIVERSAL AUXILIARY RELAY, with support

REPLACES / REEMPLAZA:

Mercedes Benz: 0025421319

APPLICATION / APLICACIÓN:

Universal, general purpose

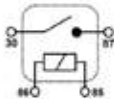
GE0057

FEATURES / CARACTERÍSTICAS: 12V - 70A - 4 TERMINALS - INJECTION/ AUXILIARY RELAY, without support

REPLACES / REEMPLAZA:

VW: 191937503, 211911253.1, 357906381A, 357906381B, 357911251A, 357911351A, 7M0951253A, 8D0951253; **Troller:** 8RRE20N-159;

GM: 90226846, 90357989, 94611312, 13500120, 90226846; **Fiat:** 7752313; **Toyota:** 90987-02016, 90987-T2002, 90080-87024;

New Holland: 82012872, 83989947, 90987-04006, 90987-02030; **Renault:** 7700844682; **Volvo:** 9441158; **Ford:** 191937503, 81AG14N084C, 83BG14N089CA, 93BG14N089CA, 93BG14N089CB, 93BG14N089C1B; **Hyundai/ Kia:** 36860-4X000, 85210-29000, 95245-M2000

APPLICATION / APLICACIÓN:

GM: Corsa (all), Agile 12;

TOYOTA: Corolla 2002>2007;

FIAT: Palio;

HYUNDAI/ KIA: Accent, Elantra, Bongo, Picanto, HR100;

VW: Kombi Diesel, Gol, Saveiro, Santana, Quantum AB-9, Logus, Golf III 1991>2002

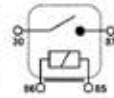
GE0058

FEATURES / CARACTERÍSTICAS: 12V - 70A - 4 TERMINALS - UNIVERSAL AUXILIARY RELAY, with support

REPLACES / REEMPLAZA:

VW/ Audi: 443951253J; **Iveco:** 51395260; **Volvo:** 3464104, 28058151; **Ford:** 83BG14N089CA; **New Holland:** 82012872, 83989947; **Massey Ferguson:** 3387326M2; **Troller/ Valtra:** 82246700; **Fiat:** 5139526, 7752313; **John Deere:** AL81719; **GM:** 93221424

APPLICATION / APLICACIÓN:

GM: Corsa (all), Agile 12;

TOYOTA: Corolla 2002>2007;

FIAT: Palio;

HYUNDAI/ KIA: Accent, Elantra, Bongo, Picanto, HR100;

VW: Kombi Diesel, Gol, Saveiro, Santana, Quantum AB-9, Logus, Golf III 1991>2002

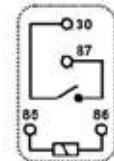
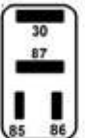
GE0059

FEATURES / CARACTERÍSTICAS: 12V - 30A - 4 TERMINALS - 2x4,5mm + 2x6mm - MINI AUXILIARY RELAY, without support

REPLACES / REEMPLAZA:

FIAT: 7676504, 46520412, 46520422; **BOSCH:** 0332011001; **GM:** 24435922, 93226612, 90608807; **JAC MOTORS:** 9522429800;

TOYOTA: 90080-87019; **HYUNDAI / KIA:** 95224-29700, 95224-29850, 95230-2P030, GSWH-062

APPLICATION / APLICACIÓN:

FIAT: Palio, Siena, Marea, Brava

GM: Corsa, Celta, Agile 2012, Vectra 2006->

JAC MOTORS: J3 e Turin

HYUNDAI: HB 20

KIA: Sportage

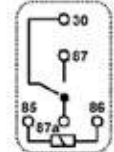
GE0060

FEATURES / CARACTERÍSTICAS: 12V - 20/ 10A - 5 TERMINALS - MINI AUXILIARY RELAY, without support

REPLACES / REEMPLAZA:

GM: 13100504, 90414477, 90511443; **John Deere:** AZ61578, AL76702; **Mercedes Benz:** 6388210047; **Renault:** 7700414484;

Massey Ferguson: 4272431M1

APPLICATION / APLICACIÓN:

GM: Corsa, Celta;

JOHN DEERE, MERCEDES BENZ, RENAULT, MASSEY FERGUSON

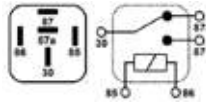
GE0061

FEATURES / CARACTERÍSTICAS: 12V - 40/ 10A - 5 TERMINALS - AUXILIARY RELAY, with support

REPLACES / REEMPLAZA:

RENAULT: 7702072115, 7702218610; **MERCEDES BENZ:** 3445427119, 6645427119, 6885427619; **PEUGEOT:** 7905522200; **CITROËN:** 7905522200, 6455-000; **CAIO:** 42004140; **MARCOPOLO:** 10201675.5; **CHRYSLER:** 4143779; **VW:** 4143779, 325911264.1; **GM:** 04243779, 94606308; **FORD:** 78AU1504OA, 84AU19W572A, 93BGI3A025A1B, EZHT4A156BA

APPLICATION / APLICACIÓN:

RENAULT: R-9, R-11, R-12, R-18, R-19, R-21, R-25, Clio, Traffic, Twingo, Express, Nevada

MERCEDES BENZ: Trucks (all)

PEUGEOT: 205, 306, 405

CITROËN: Xantia, Xsara

CAIO: Bus

MARCOLOPOLO: Bus

VW: Dodge Polara

GM: Opala, Caravan

FORD: Galaxie, LTD, Landau (all)

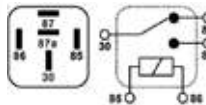
GE0062

FEATURES / CARACTERÍSTICAS: 24V - 40/ 30A - 5 TERMINALS - AUXILIARY RELAY, without support

REPLACES / REEMPLAZA:

Ford: 110010750; **Foton:** 1B18037500016; **GM:** 3436400; **Irizar:** 539636; **John Deere:** 15730019; **Liebherr:** 630160214; **Marcopolo:** 10201674-9; **Randon:** 102016755; **Scania:** 02991710, 04718222, 11646486, 1391322, 1391323, 1431781, 1504951, 2077837, 235940, 235942, 243460, 243879, 25001539, 400782, 41040442, 539509, 63447; **DAF:** 0114571, 0267701, 086751, 0867517; **Mercedes Benz:** 0015310560, 0015421119, 0035259605, 0035459606, 0045453605, 0045455805, 0005455405, 0005458405, 0005459005, 0008201710, 3505427019, 3505427119, 3505427719, 7375111000; **Renault Trucks:** 5000084772, 5516038408; **VW/ Ford:** 2P0941589A; **Caio/ Induscar:** 042004068, 042004121, 042004140; **Man:** 7785000020, 81259020058, 81259020081, 81259020100, 81259020130, 81259020165, 81259020234, 81259020250, 81259020251, 81259020253, 88259020005; **Volvo:** 1259926, 1504957, 20374662, 239883, 344686, 4786690, 8153600, 837878; **BMW:** 7220100; **Caterpillar:** 7Y-5490; **Comil:** 2093102027

APPLICATION / APLICACIÓN:

TRUCKS AND BUS: CAIO; **COMIL;** DAF; **FORD;** FOTON; **IRIZAR;** IVECO; **MAN;** MARCOPOLO; **MERCEDES-BENZ;** RANDON; **RENAULT;** SCANIA; **UNIVERSAL;** VOLVO; **VW**

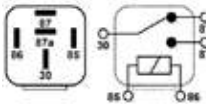
GE0063

FEATURES / CARACTERÍSTICAS: 24V - 40/ 30A - 5 TERMINALS - UNIVERSAL AUXILIARY RELAY, with support

REPLACES / REEMPLAZA:

VOLVO: 1504957, 241595, 3712071, 4786690, 837878, 870451; **MARCOPOLO:** 102016749; **NEOBUS:** 20200146; **VW:** KDWHL09113; **CAIO / INDUSCAR:** 42004068; **COMIL:** 02027; **FIAT:** 02471298EE, 1164018, 32190845, 5158609; **MASCARELLO:** 3995; **JOHN DEERE:** 14372, 59024, 15730019; **MERCEDES BENZ:** 3505427019, 3505427119, 3505427719, 3865427719; **SCANIA:** 1504951, 243460

APPLICATION / APLICACIÓN:

TRUCKS AND BUS: CAIO; **COMIL;** FIAT; **JOHN DEERE;** MARCOPOLO; **MASCARELLO;** MERCEDES-BENZ; **NEOBUS;** SCANIA; **VOLVO;** VOLKSWAGEN

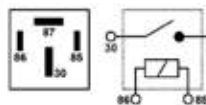
GE0064

FEATURES / CARACTERÍSTICAS: 24V - 70A - 4 TERMINALS - AUXILIARY RELAY, without support

REPLACES / REEMPLAZA:

Mercedes Benz: 3645427319; **Renault Trucks:** 5000787913, 5010589425; **Volvo:** 20390648, 21255974; **Scania:** 1407909, 1439172, 1543731, 303535, 543731; **DAF:** 1669972; **MAN:** 81259020264, 81259020317, 81259020363, 81259020425, 81259020452, 81259020491, 81259020519, 81259020520

APPLICATION / APLICACIÓN:

TRUCKS AND BUS: DAF; **MAN;** MERCEDES-BENZ; **RENAULT;** SCANIA; **VOLVO**

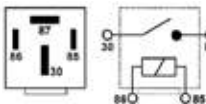
GE0065

FEATURES / CARACTERÍSTICAS: 24V - 70A - 4 TERMINALS - UNIVERSAL AUXILIARY RELAY, with support

REPLACES / REEMPLAZA:

Mercedes Benz: 3645427319; **Volvo:** 1407909, 1439172; **Scania:** 1543731, 303535; **Ford:** 97CT15K235BA, 97CT15K235CA; **Iveco:** 6450030, 97103581

APPLICATION / APLICACIÓN:

MERCEDES BENZ: Bus O-370, O-371;

VOLVO: Trucks and Bus 75>;

SCANIA: Trucks and Bus 75>

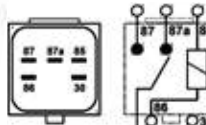
GE0066

FEATURES / CARACTERÍSTICAS: 12V - 5 TERMINALS - AUXILIARY/ INJECTION RELAY, with support

REPLACES / REEMPLAZA:

GM: 12077864, 12193611, 960572A, 96251271, VF2835F14205

APPLICATION / APLICACIÓN:

GM: Blazer, S-10, Silverado, Lumina APV 2.3 1989>1996

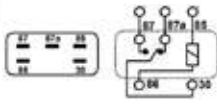
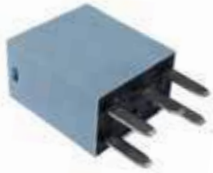
GE0067

FEATURES / CARACTERÍSTICAS: 12V - 15/ 10A - 5 TERMINALS - AUXILIARY/ INJECTION RELAY, without support

REPLACES / REEMPLAZA:

GM: 12077866, 13500128, 13502750, 13361776, 15328867, 19115082, 19116058; **Fiat:** 5269988AA; **Hyundai/ Kia:** 9522538300; **Mack:** 25192984; **Chrysler:** 51793487AA, 5269988AA; **John Deere:** RE73096, SJ15809, LVA13711

APPLICATION / APLICACIÓN:

GM: S-10, Blazer, Silverado;

FIAT: Freemont 12>14;

CHRYSLER: 300 2005>2012, PT Cruiser 2001>2010, Neon 2000>2002, Dakota 2001, Dodge Caravan 2001>2007, Charger 2006>2011

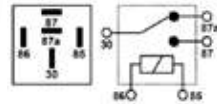
GE0068

FEATURES / CARACTERÍSTICAS: 12V - 50/ 30A - 5 TERMINALS - UNIVERSAL AUXILIARY RELAY, with support

REPLACES / REEMPLAZA:

Caterpillar: 3E9362; **Hyundai/ Kia:** 39160-3C200; **Llifan:** JD1914; **New Holland:** 86529089; **Scania:** 9596560

APPLICATION / APLICACIÓN:

Ideal for agricultural machinery

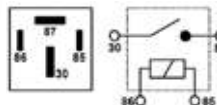
GE0069

FEATURES / CARACTERÍSTICAS: 12V - 80A - 4 TERMINALS - UNIVERSAL AUXILIARY RELAY, without support

REPLACES / REEMPLAZA:

GM: 90459642; **New Holland:** 82012872; **Toyota:** 90987-T2002

APPLICATION / APLICACIÓN:

Universal, General Purpose, Agricultural Machinery, Sealed

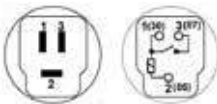
GE0070

FEATURES / CARACTERÍSTICAS: 12V - 22A - 3 TERMINALS - MINI AUXILIARY RELAY, without support

REPLACES / REEMPLAZA:

Toyota: 9098701003, 056700-4800

APPLICATION / APLICACIÓN:

TOYOTA: Hilux, SW4 1992>2001

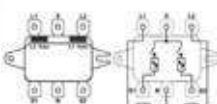
GE0071

FEATURES / CARACTERÍSTICAS: 12V - 6 TERMINALS - HEADLIGHT RELAY, with bolt

REPLACES / REEMPLAZA:

GM: 90459642; **New Holland:** 82012872; **Toyota:** 90987-T2002

APPLICATION / APLICACIÓN:

Universal, General Purpose, Agricultural Machinery, Sealed

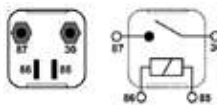
GE0072 // NEW //

FEATURES / CARACTERÍSTICAS: RELAY, MAIN CURRENT - 4 terminais - 12V, 200A

REPLACES / REEMPLAZA:

EFEL: 06020, 6020; **PIAGGIO:** 157713, 1E000371; **ERA:** 661304

APPLICATION / APLICACIÓN:

PIAGGIO: Ape Car Diesel

UNIVERSAL TRACTORS: Agriculture Engines, Industria

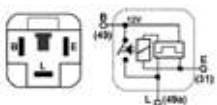
GE0073 // NEW //

FEATURES / CARACTERÍSTICAS: FLASHER RELAY - 3 terminais - 12V, 27W

REPLACES / REEMPLAZA:

TOYOTA/DENSO: 81980-12070, 166500-0300

APPLICATION / APLICACIÓN:

TOYOTA: Hiace, Hilux, RAV4, Corolla, Camry, MR2

LEXUS: LS400, ES300, GS300

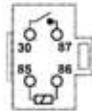
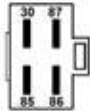
GE0074 // NEW //

FEATURES / CARACTERÍSTICAS: UNIVERSAL RELAY - 4 terminais - 12V, 30A

REPLACES / REEMPLAZA:

MITSUBISHI: MB229456, MB627895, MB141967, MB183865, MB141980

APPLICATION / APLICACIÓN:

...

GE0075 // NEW //

FEATURES / CARACTERÍSTICAS: 400W - 24V - FLASHER RELAY - 4 PIN

REPLACES / REEMPLAZA:

MERCEDES-BENZ: 0015449132, 0025445532 **VOLVO:** 1224492H1

APPLICATION / APLICACIÓN:

MERCEDES BENZ: Truck and Bus;

VOLVO: Truck, Bus and Wagons;

KOMATSU: Tractor

GE0077 // NEW //

FEATURES / CARACTERÍSTICAS: 13 TERMINALS

REPLACES / REEMPLAZA:

VDO: D09436

APPLICATION / APLICACIÓN:

SCANIA: Trucks / Bus 1975>

GE0078 // NEW //

FEATURES / CARACTERÍSTICAS: 24V - FLASHER RELAY - 16 TERMINALS

REPLACES / REEMPLAZA:

MARÍLIA: IM-11.460

APPLICATION / APLICACIÓN:

SCANIA: Trucks / Bus

GE0079 // NEW //

FEATURES / CARACTERÍSTICAS: 13 TERMINALS

REPLACES / REEMPLAZA:

VOLVO: 4DJ 004 589 00; **DNI:** 8850

APPLICATION / APLICACIÓN:

VOLVO: Trucks / Bus 1975>

GE0080 // NEW //



FEATURES / CARACTERÍSTICAS: 24V - FLASHER RELAY - 13 TERMINALS

REPLACES / REEMPLAZA:

SCANIA: SC1334196

APPLICATION / APLICACIÓN:

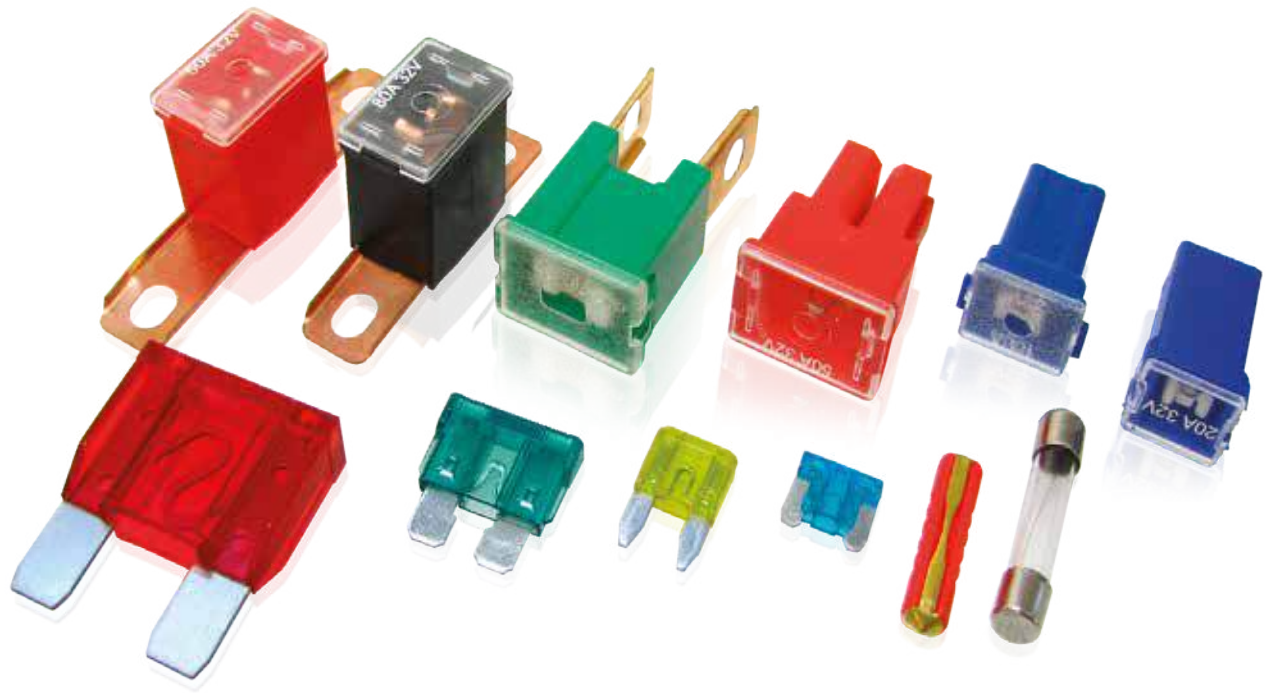
SCANIA: Trucks / Bus



ELECTRICAL SPARE PART | PIEZA ELÉCTRICA

FUSE | FUSIBLE

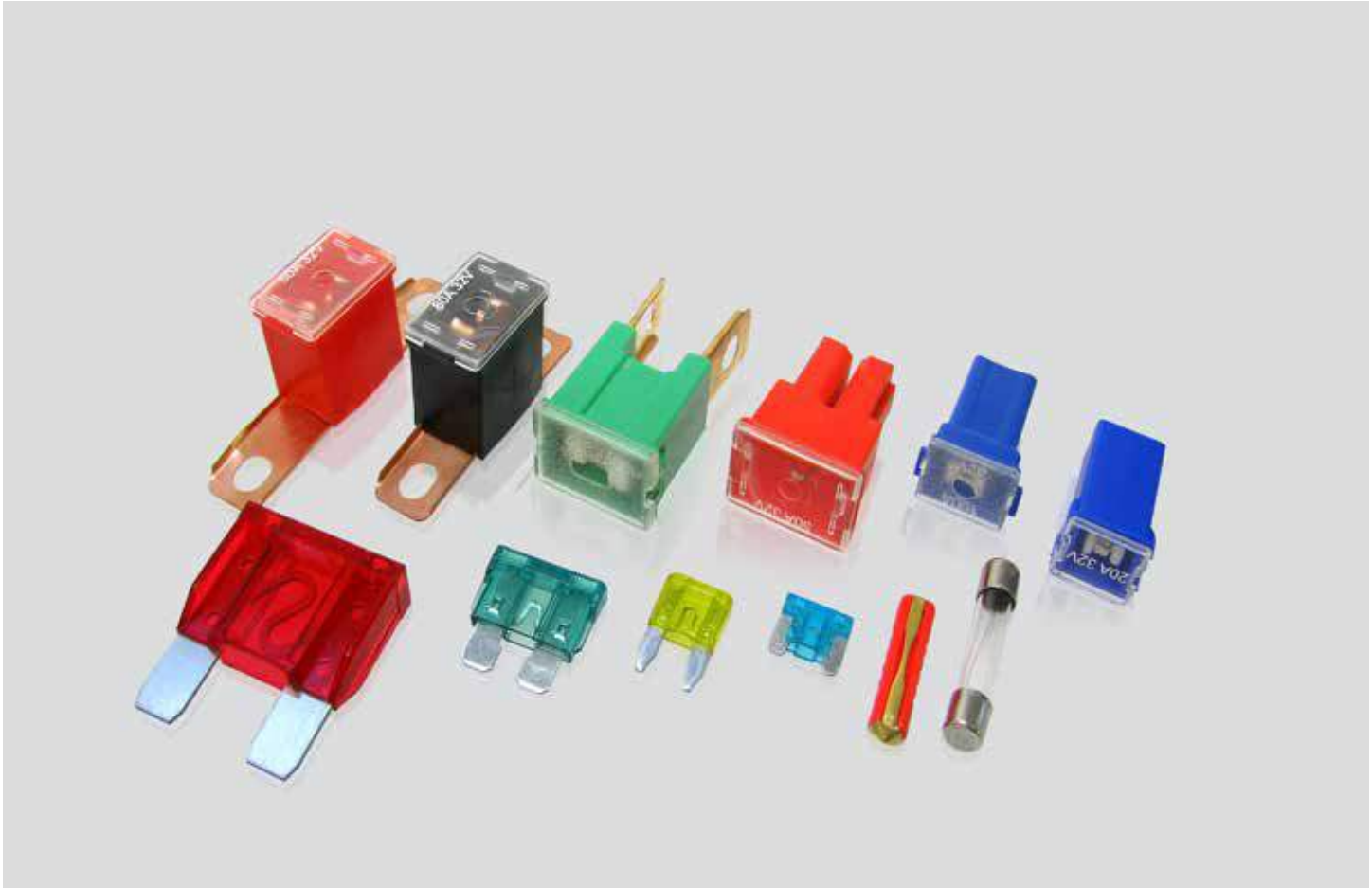

GAUSS CODE | CÓDIGO GAUSS

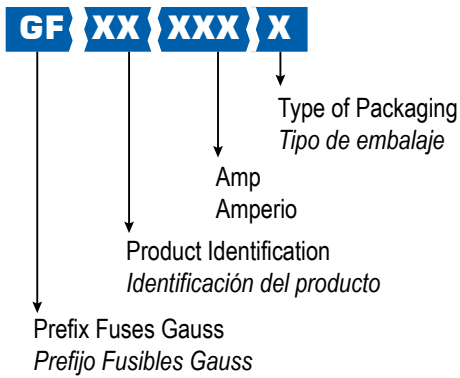

Examples | Ejemplos:

GF	10	003	A
GF	14	025	C
GF	18	120	E

A	= Blister with 10 units	Blister con 10 unidades
C	= Box with 100 units	Caja con 100 unidades
E	= Box with 10 units	Caja con 10 unidades
F	= Box with 20 units	Caja con 20 unidades
G	= Box with 200 units	Caja con 200 unidades
H	= Box with 40 units	Caja con 40 unidades

STANDARD BLADE

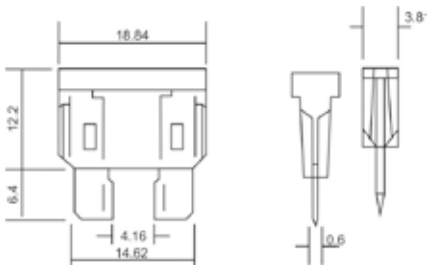

CODE CÓDIGO	QUANT.	AMP
GF10003C	Box/Caja 100	3A
GF10004C	Box/Caja 100	4A
GF10005C	Box/Caja 100	5A
GF10007C	Box/Caja 100	7,5A
GF10010C	Box/Caja 100	10A
GF10015C	Box/Caja 100	15A
GF10020C	Box/Caja 100	20A
GF10025C	Box/Caja 100	25A
GF10030C	Box/Caja 100	30A
GF10035C	Box/Caja 100	35A
GF10040C	Box/Caja 100	40A

STANDARD BLADE - MIX

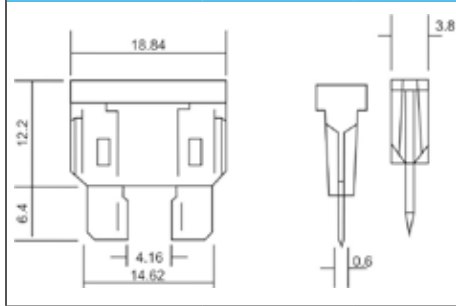

CODE CÓDIGO	QUANT.	AMP
GF10000C	Box/Caja 100	10X5A / 10X7,5A/ 20X10A/ 20X15A/ 20X20A/ 10X25A/ 10X30A

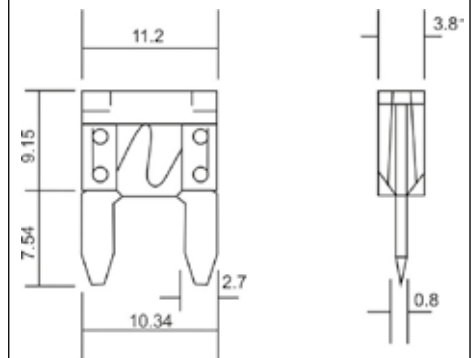
MINI

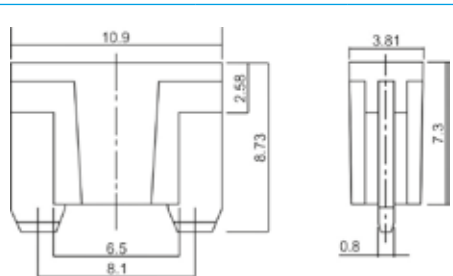

CODE CÓDIGO	QUANT.	AMP
GF11003G	Box/Caja 200	3A
GF11004G	Box/Caja 200	4A
GF11005G	Box/Caja 200	5A
GF11007G	Box/Caja 200	7,5A
GF11010G	Box/Caja 200	10A
GF11015G	Box/Caja 200	15A
GF11020G	Box/Caja 200	20A
GF11025G	Box/Caja 200	25A
GF11030G	Box/Caja 200	30A

MINI

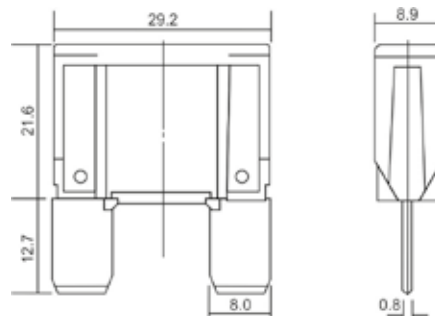

CODE CÓDIGO	QUANT.	AMP
GF12005G	Box/Caja 200	5A
GF12007G	Box/Caja 200	7,5A
GF12010G	Box/Caja 200	10A
GF12015G	Box/Caja 200	15A
GF12020G	Box/Caja 200	20A
GF12025G	Box/Caja 200	25A
GF12030G	Box/Caja 200	30A

MAXI

CODE CÓDIGO	QUANT.	AMP
GF13020F	Box/Caja 20	20A
GF13030F	Box/Caja 20	30A
GF13040F	Box/Caja 20	40A
GF13050F	Box/Caja 20	50A
GF13060F	Box/Caja 20	60A
GF13070F	Box/Caja 20	70A
GF13080F	Box/Caja 20	80A
GF13100F	Box/Caja 20	100A

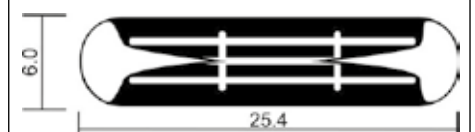

CERAMIC

CODE CÓDIGO	QUANT.	AMP
GF14008A	Blister 10	8A
GF14015A	Blister 10	15A
GF14020A	Blister 10	20A
GF14025A	Blister 10	25A
GF14030A	Blister 10	30A



GLASS

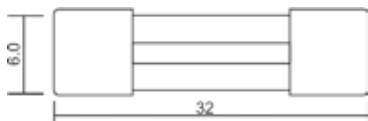

CODE CÓDIGO	QUANT.	AMP
GF15005A	Blister 10	5A
GF15010A	Blister 10	10A
GF15015A	Blister 10	15A
GF15020A	Blister 10	20A
GF15030A	Blister 10	30A

MALE PAL

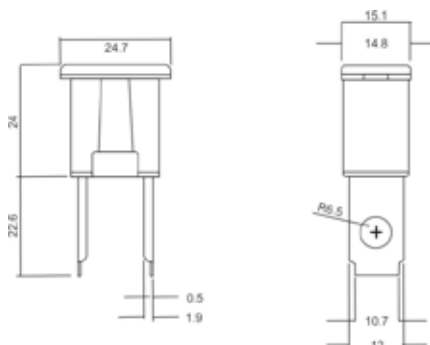

CODE CÓDIGO	QUANT.	AMP
GF18030E	Box/Caja 10	30A
GF18040E	Box/Caja 10	40A
GF18050E	Box/Caja 10	50A
GF18060E	Box/Caja 10	60A
GF18070E	Box/Caja 10	70A
GF18080E	Box/Caja 10	80A
GF18100E	Box/Caja 10	100A
GF18120E	Box/Caja 10	120A

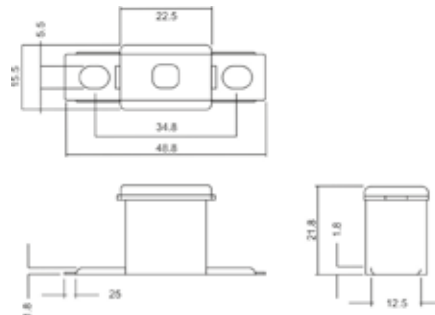
PAL

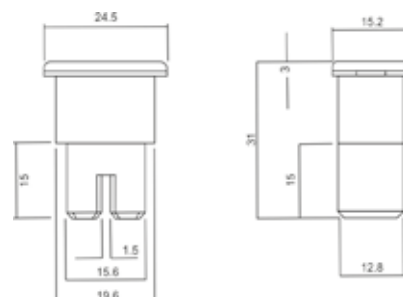

CODE CÓDIGO	QUANT.	AMP
GF16030E	Box/Caja 10	30A
GF16040E	Box/Caja 10	40A
GF16050E	Box/Caja 10	50A
GF16060E	Box/Caja 10	60A
GF16070E	Box/Caja 10	70A
GF16080E	Box/Caja 10	80A
GF16100E	Box/Caja 10	100A
GF16120E	Box/Caja 10	120A

FEMALE PAL

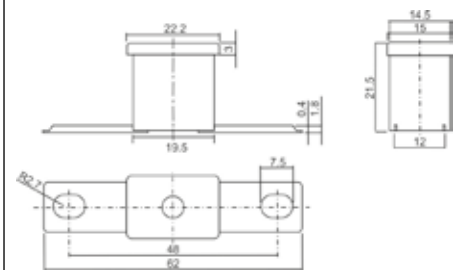

CODE CÓDIGO	QUANT.	AMP
GF19020E	Box/Caja 10	20A
GF19030E	Box/Caja 10	30A
GF19040E	Box/Caja 10	40A
GF19050E	Box/Caja 10	50A
GF19060E	Box/Caja 10	60A
GF19070E	Box/Caja 10	70A
GF19080E	Box/Caja 10	80A

PAL

CODE CÓDIGO	QUANT.	AMP
GF17030E	Box/Caja 10	30A
GF17040E	Box/Caja 10	40A
GF17050E	Box/Caja 10	50A
GF17060E	Box/Caja 10	60A
GF17070E	Box/Caja 10	70A
GF17080E	Box/Caja 10	80A
GF17100E	Box/Caja 10	100A
GF17120E	Box/Caja 10	120A

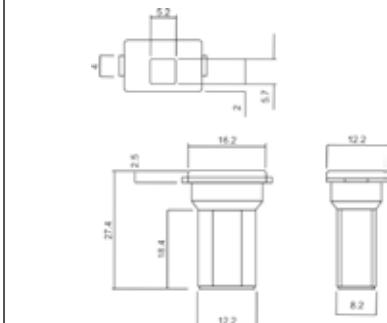

PAL

CODE CÓDIGO	QUANT.	AMP
GF20020F	Box/Caja 20	20A
GF20030F	Box/Caja 20	30A
GF20040F	Box/Caja 20	40A
GF20050F	Box/Caja 20	50A
GF20060F	Box/Caja 20	60A
GF20070F	Box/Caja 20	70A
GF20080F	Box/Caja 20	80A
GF20100F	Box/Caja 20	100A



PAL

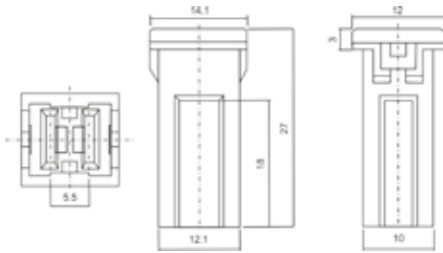

CODE CÓDIGO	QUANT.	AMP
GF21020F	Box/Caja 20	20A
GF21030F	Box/Caja 20	30A
GF21040F	Box/Caja 20	40A
GF21050F	Box/Caja 20	50A
GF21060F	Box/Caja 20	60A
GF21070F	Box/Caja 20	70A
GF21080F	Box/Caja 20	80A
GF21100F	Box/Caja 20	100A

MICRO II BLADE FUSES

CODE CÓDIGO	QUANT.	AMP
GF24005G	Box/Caja 200	5A
GF24007G	Box/Caja 200	7,5A
GF24010G	Box/Caja 200	10A
GF24015G	Box/Caja 200	15A
GF24020G	Box/Caja 200	20A
GF24025G	Box/Caja 200	25A
GF24030G	Box/Caja 200	30A

MINI PAL

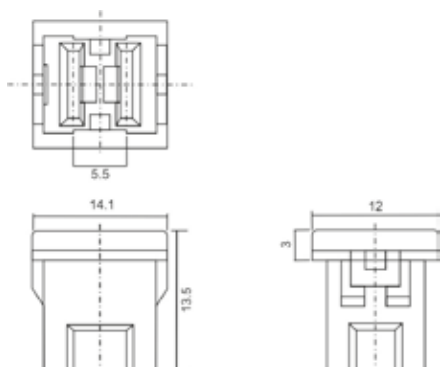
CODE CÓDIGO	QUANT.	AMP
GF22020H	Box/Caja 40	20A
GF22030H	Box/Caja 40	30A
GF22040H	Box/Caja 40	40A
GF22050H	Box/Caja 40	50A
GF22060H	Box/Caja 40	60A
GF22070H	Box/Caja 40	70A
GF22080H	Box/Caja 40	80A
GF22100H	Box/Caja 40	100A

STRIPS FUSES

CODE CÓDIGO	QUANT.	AMP
GF25030G	Box/Caja 200	30A
GF25040G	Box/Caja 200	40A
GF25050G	Box/Caja 200	50A
GF25060G	Box/Caja 200	60A
GF25080G	Box/Caja 200	80A
GF25110G	Box/Caja 200	110A
GF25150G	Box/Caja 200	150A
GF25175G	Box/Caja 200	175A



EMS COMPONENTS | SISTEMA DE CONTROL DE MOTOR

FUEL PUMP | BOMBA DE COMBUSTIBLE



G16004

FEATURES / CARACTERÍSTICAS: **UNIVERSAL**

REPLACES / REEMPLAZA:

DAIHATSU: 23100-87546-000; DENSO: 056200-0582

APPLICATION / APLICACIÓN:

-



G16006

FEATURES / CARACTERÍSTICAS: **UNIVERSAL**

REPLACES / REEMPLAZA:

DAIHATSU: UC-V4

APPLICATION / APLICACIÓN:

SUZUKI: SUPER CARRY



G16007

FEATURES / CARACTERÍSTICAS: **AUTOMOTIVE - 2.5~4.0 PSI - 20 GPH**

REPLACES / REEMPLAZA:

FACET: 40106; PERFORMANCE: P-502

APPLICATION / APLICACIÓN:

Pass. & Light Truck Carbureted



G16008

FEATURES / CARACTERÍSTICAS: **AUTOMOTIVE - 4.0~6.0 PSI - 25 GPH**

REPLACES / REEMPLAZA:

AC DELCO: EP259; CARTER: P60432; FACET: 40106; PERFORMANCE: P-502

APPLICATION / APLICACIÓN:

Pass. & Light Truck Carbureted/Up to / 350CID Engines Using 5/16" Hose



G16008B // NEW //

FEATURES / CARACTERÍSTICAS: **AUTOMOTIVE - 4.0~6.0 PSI - 25 GPH, with reinforced resin**

REPLACES / REEMPLAZA:

AC DELCO: EP259; CARTER: P60432; FACET: 40106; PERFORMANCE: P-502

APPLICATION / APLICACIÓN:

Pass. & Light Truck Carbureted/Up to / 350CID Engines Using 5/16" Hose



G16009

FEATURES / CARACTERÍSTICAS: **AUTOMOTIVE - 6.0~9.0 PSI - 30 GPH**

REPLACES / REEMPLAZA:

FACET: 40107

APPLICATION / APLICACIÓN:

Pass. & Light Truck Carbureted/Up to / 350CID Engines Using 5/16" Hose



G16010

FEATURES / CARACTERÍSTICAS: **UNIVERSAL**

REPLACES / REEMPLAZA:

HKT: HEP-02A

APPLICATION / APLICACIÓN:

TOYOTA, NISSAN, MAZDA



G16011

FEATURES / CARACTERÍSTICAS: **AUTOMOTIVE - 6.0~9.0 PSI**

REPLACES / REEMPLAZA:

AIRTEX: E8012S; CARTER: P60430; OEM: 6414671; PERFORMANCE: P-12K

APPLICATION / APLICACIÓN:

Pass. & Light Truck Carbureted/Up to / 350CID Engines Using 5/16" Hose



GI6012

FEATURES / CARACTERÍSTICAS: **AUTOMOTIVE - 2.5~4.5 PSI**

REPLACES / REEMPLAZA:

AIRTEX: E8014S; **CARTER:** P74029; **OEM:** 6440219; **PERFORMANCE:** P-11K

APPLICATION / APLICACIÓN:

Pass. & Light Truck Carbureted



GI4200

FEATURES / CARACTERÍSTICAS: **12V 10-14 P.S.I 35 G.P.H**

REPLACES / REEMPLAZA:

AIRTEX: E8153

APPLICATION / APLICACIÓN:

12 volts diesel engines



GI4127

FEATURES / CARACTERÍSTICAS: **AUTOMOTIVE - 12V - 0,3 MPA - 135 L/H**

REPLACES / REEMPLAZA:

PERFORMANCE: P42K; **CARTER:** P74127; **AIRTEX:** E7048M; **KEM:** 125E

APPLICATION / APLICACIÓN:

DAKOTA: 4 Cil. V6 / 2.5 / 3.9 / 1994~1995, **DODGE:** PICK UP V6, V8 / 3.7 / 5.2 / 5.9 / 1993~1997, **MICROBUS:** V6, V8 / 3.7 / 5.2 / 5.9 / 1993~1997, **RAM CHARGER:** V6, V8 / 3.7 / 5.2 / 5.9 / 1993~1997, **PICK UP:** D100 V6, V8 / 3.7 / 5.2 / 5.9 / 1991~1997 - D150, D250, D350 TBI V6, V8 / 3.7 / 5.2 / 5.9 / 1991~1993 - D150, D250, D350 MPFI V6, V8 / 3.7 / 5.2 / 5.9 / 1994~1997, **RAM CHARGER:** V8 / 5.2 / 5.9 / 1991~1997



GI DPA002

FEATURES / CARACTERÍSTICAS: **13.5V 0 BAR 140L/H**

REPLACES / REEMPLAZA:

PERKINS: 4132A015

APPLICATION / APLICACIÓN:

30 KVA Perkins engine



GI DPA003

FEATURES / CARACTERÍSTICAS: **13.5V 0 BAR 140L/H**

REPLACES / REEMPLAZA:

PERKINS: 4132A014; **CATERPILLAR:** 1R-0793

APPLICATION / APLICACIÓN:

-



GI DPA005

FEATURES / CARACTERÍSTICAS:

REPLACES / REEMPLAZA:

87802238, 87327688, 87802202

APPLICATION / APLICACIÓN:

CASE/IH (MXM SERIES): MXM 120, 130, 135, 140, 150, 155, 165, 175, 180, 190

FIAT (M SERIES): M100, 115, 135, 160

FIAT (TM SERIES): TM100, 115, 120, 125, 130, 135, 140, 150, 155, 165, 175

FIAT (TS SERIES): TS 90, 100, 110, 115

FORD NEW HOLLAND: 10 Series 5610S, 6610S, 6810S, 7010S, 7610S, 8010S, 60 Series, 8160, 8260, 8360

BACKHOE: 555E, 575E, 655E, 675E, LB75, LB110, LB115



GI3000 // NEW //

FEATURES / CARACTERÍSTICAS: **3 BAR, 150L/H, Gasoline/ Diesel**

REPLACES / REEMPLAZA:

BOSCH: 0 580 100 000

APPLICATION / APLICACIÓN:

FIAT: Qubo 1.4

G13050 // NEW //

FEATURES / CARACTERÍSTICAS:

REPLACES / REEMPLAZA:

VW: A2E53407268, 2H0919050D

APPLICATION / APLICACIÓN:

VOLKSWAGEN: Amarok 2.0 TDI / 2.0 TDI 4motion 2012>

G13121 // NEW //

FEATURES / CARACTERÍSTICAS: 12V, 4 BAR, 100L/H

REPLACES / REEMPLAZA:

Bosch: 0580454008; **Kit Bosch:** F000TE0120; **Delphi:** BCD 00023; **Magneti Marelli:** MAM 218, **Weber:** WB022

APPLICATION / APLICACIÓN:

FORD: Escort, Versailles, Verona, Royale 93> (álcool e bicombustível); **FIAT:** Tempra , Palio /Weekend, Uno, Strada 93> (álcool e bicombustível); **VW:** Gol, Parati, Fox Total Flex 93>, Saveiro, Santana, Quantum 93>, Logus, Pólo, Pointer 93> (álcool e bicombustível), Kombi 1.6 MI 98>05; **GM:** Astra, Corsa, Meriva, Montana 93> (álcool e bicombustível); **PEUGEOT:** 308; **RENAULT:** Clío Sedan, Scenic Hi- Flex.

G13122 // NEW //

FEATURES / CARACTERÍSTICAS: 3.8 BAR, 122 L/H. Applicable only in full Bosch pump

REPLACES / REEMPLAZA:

BOSCH: F 000 TE1 89P, 0 580 454 120

APPLICATION / APLICACIÓN:

CHEVROLET: Onix 1.0 2012> Flex, Prisma 1.0 2012> Flex

G13128 // NEW //

 FEATURES / CARACTERÍSTICAS: 3.0 BAR, 145 L/H. Applicable only with full pump / Aplicable sólo en bomba completa: **GM:** 13510802, 13579569, 13591800, 13592878, 13597395, 13507350

REPLACES / REEMPLAZA:

COAVIS: KGF2.6

APPLICATION / APLICACIÓN:

CHEVROLET: Onix 1.0 2012> Flex, Prisma 1.0 2012> Flex

G13134 // NEW //

FEATURES / CARACTERÍSTICAS: 3.0 BAR, 100 L/H

REPLACES / REEMPLAZA:

Delphi: FE10134; **GM:** 93316158, 93317877, 94734305, 25320102

APPLICATION / APLICACIÓN:

GM: Blazer 2.8 Turbo Diesel 05>09, S-10 2.8 Turbo Diesel 05>11

G13307 // NEW //

FEATURES / CARACTERÍSTICAS: Diesel Pump

REPLACES / REEMPLAZA:

WALBRO: GSS51302, 5421306

FORD: BH3T9H307AA, 5L55 9H307 CA

APPLICATION / APLICACIÓN:

FORD: Ranger 3.0 Diesel 2005>2012

G13401

FEATURES / CARACTERÍSTICAS: 12V 0 BAR 80L/H

REPLACES / REEMPLAZA:

SUZUKI: 15110-63B00, 15110-63B10

APPLICATION / APLICACIÓN:

SUZUKI: SWIFT II HATCHBACK (EA.MA)1.0 (SF310, AA44) 1.0L 03/89-05/01, SWIFT II HATCHBACK (EA.MA) 1.3 (SF413, AB35) 1.3L 03/98-05/01;

MITSUBISHI: LANCER



GI3402

FEATURES / CARACTERÍSTICAS: 12V 0 BAR 80L/H

REPLACES / REEMPLAZA:
SUZUKI: 115110-63B10

APPLICATION / APLICACIÓN:
MITSUBISHI



GI3601

FEATURES / CARACTERÍSTICAS: 12V 3.0 BAR 100L/H

REPLACES / REEMPLAZA:

AC DELCO: EP314, EP346, EP351, EP355, EP356, EP360, EP361, EP370, EP371, EP374, EP396, EP437; **AIRTEX**: E2001, E2002, E2042, E2051, E2052, E2056, E2061, E2065, E5067, E2073; **DELPHI**: FE0078, FE0090, FE0105, FE0106, FE0109, FE0154, FE0222, FE0236, FE0310, FE0311, FE0052; KEM: FFP201, FFP202, FFP5051; **WALBRO**: 520, 521, 525, 526, 5CA201, 5CA202, 5CA204, 5CA206, 5CA210, 5CA212, 5CA2235CA225, 5CA229, 5CA273, 5CA3310, 5CA400, 5CA421; **FORD**: E83Z-9H307B, E39Z-9H307A, E55Y 9A407 A, E5SZ 9A407 B, E5ZZ-9A407A, E69Z 9H307 G, E6DZ-9H307A, E6LY 9A407 A, E83Z 9H307 A, E9SZ-9H307A, E9TZ 9H307 B, E9TZ 9H307 E, F02Z 9H307 A, F03Z 9H307 A, F0AZ9H307A, F0CZ-91307A, F13Z-9H307, F1DZ-91-1307C, F1TZ-93079, F1TZ 9H307 B, F1VY9H307A, F1ZZ 9A407 B, F2AZ 9H307 A, F39Z-9H307A, F3DZ-9H307E, F4ZZ-9350C, F90Z 9H307 A, FIZZ9A407B, FOAZ 9H307 C, FOCZ 9H307 A, FODZ 9H307 A, FOSZ-91-1307A, FOTZ 9H307 F, FOVY-91-1307C, FSCZ-9350B; **GM**: 6443523, 25116974, 25116975, 25117240, 25117752, 25117753, 25117754, 25117755, 25117756, 25117757, 25117758, 25117759, 25117760, 25164852, 25164853, 25164854, 25165262, 25165940, 25165941, 25165942, 25175121, 25175124, 52117356; JEEP: 52018407; LADA: 6443650; MAZDA: ZZL013350B, ZZL013350Z, ZZL013350A, ZMZ013350, ZMZ113350, ZMZ413350, ZMZ513350

APPLICATION / APLICACIÓN:

ALFA ROMEO: 155 (167) 1.7 T.S. 1.8 T.S. 2.0 T.S. 04/93-04/96, 155 (167) 1.7L/1.8T/2.0T/1.7T 04/93-04/96;

FORD: FIESTA III (GFJ) 1.1 (L2)/1.3 CAT (L2)/1.4 (L2)/1.3 (L2) 03/89-04/94, FIESTA FURGON (F3L, F5L) 1.3 (L2) 09/91-04/94, FIESTA III (GFJ) 1.1 (L2), 1.3 CAT (L2), 1.4 (L2) 1.1 (L2) 03/89-04/94, FIESTA FURGON (F3L, F5L) 1.3 (L2) 09/91-;

FORD USA: EXPLORER (U2) 4.0 V6 01/93-11/94, AEROSTAR 4.0 I V6 4WD, 3.0 I V6 03/86-12/97, AEROSTAR 09/89-12/97;

LANCIA: DEDRA(835) 1.6L/1.8L/2.0L 07/94-07/89;

RENAULT: CLIO I 1.1L 01/90-12/98, CLIO 1.4L 01/96-12/98;

SAAB: 900 2.0L 02/84-12/90, 02/94-12/98; 900 2.3L 02/89-12/98;

VOLVO: 440 1.6L/1.7 04/90-12/96; 480 1.7L 04/88-08/96;

MAZDA: B2200 09/90-12/97;

FORD: ESCORT 1.8L/1.9L/2.0L 01/95-12/98, MONDEO 1.6L/1.8L/2.0L 02/93-12/97, ORION'91 1.6L/1.8L/2.0L 02/91-12/93, SIERRA 1.6L 06/88-12/92;

FIAT: BRAVA(182) 1.6L 10/95-10/01; BRAVA(182) 1.8L 10/95-10/01.



GI3601A

FEATURES / CARACTERÍSTICAS: 12V 3.0 BAR 100L/H

REPLACES / REEMPLAZA:

AC DELCO: EP489; **FORD**: E7F9H307B, E90Z9H307A; **WALBRO**: 5CH246

APPLICATION / APLICACIÓN:

GM; **CHRYSLER**; **MAZDA (15)**; **B2300 (4)**; **FORD**: ESCORT 1.8L/1.9L/2.0L 01/95>12/98; **JAGUAR**: XJ6 L6-3980CC L FI/ Vin 7DOHC 09/93>12/94



GI3601D

FEATURES / CARACTERÍSTICAS: 12V 3.0 BAR 100L/H

REPLACES / REEMPLAZA:

AIRTEX: E2065, E2001; **FORD**: E83Z9H307B, F23Z9A407A, F23Z9H307A, F4CZ9A407B, F5CZ9350B, F7CZ9350AA; KEM: EFP2050

APPLICATION / APLICACIÓN:

FORD: EXPLORER 4.0L 09/91-12/94; **MAZDA**



GI3601J

FEATURES / CARACTERÍSTICAS: 12V 3.0 BAR 100L/H

REPLACES / REEMPLAZA:

AIRTEX PRODUCTS S.A.: E10218; **RENAULT**: 250601161R, 250604410R, 7700802176, 7700802178, 7700802179, 7700808949, 7700812372, 7700812372A, 7700826177, 7700827641, 7700828785, AOR034; **ROBERT BOSCH GMBH**: 0 580 453 030, 0 580 453 045; S.I.D.A.T. S.r.l.: 70003; **TI Automotive Fuel Systems**: 5CA305, AOU195, MSS234, MSS263; **VALEO SERVICE DEUTSCHLAND GMBH**: 347200, 347221

APPLICATION / APLICACIÓN:

RENAULT: CLIO I (B/C57_, 5/357_) 1.8 70Kw 95CV 1794cc, 1.8 (B/C578) 66Kw 90CV 1794cc, 1.8 16V (C57D) 99Kw 135CV 1764cc, 1.8 Rsi (B/C579) 80Kw 109CV 1794cc, 1.8 Rsi (B/C57H) 79Kw 107CV 1783cc, Williams (B/C57M) 108Kw 147CV 1998cc/ SAFRANE I (B54_) 2.0 (B540) 77Kw 105CV 1995cc, 2.0 12V (B542, B54E) 97Kw 132CV 1995cc, 2.2 (B541) 79Kw 107CV 2165cc, 2.2 (B543) 101Kw 137CV 2165cc, 3.0 V6 (B54B, B544) 123Kw 167CV 2963cc, 3.0 V6 4x4 (B54B, B544) 123Kw 167CV 2963cc/ SAFRANE II (B54_) 2.0 16V (B54L) 100Kw 136CV 1948cc, 2.5 20V (B54F) 121Kw 165CV 2435cc, 2.9 24V (B54N) 140Kw 190CV 2946cc, 3.0 V6 (B54M) 123Kw 167CV 2963cc.

GI3602

FEATURES / CARACTERÍSTICAS: 12V 3.0 BAR 100L/H

REPLACES / REEMPLAZA:

AC DELCO: EP275; **HYUNDAI**: 31110-23010, 31110-33100, 31111-23001; **RENAULT**: 7700849037; **ROVER**: AOA113, AUU1581, EOA005, EOA112, WFX 10006, WFX10017, WFX 100590; **WALBRO**: 5CA205, 5CA273; **DELPHI**: FE0055; **FORD**: E9SZ-9H307A, F1TZ9H307B, F2AZ9H307A, FOSZ-9H307A, FOVY-9H307C; **AIRTEX**: E8198

APPLICATION / APLICACIÓN:

CHRYSLER: LE BARON 2.5 L 09/86-12/90; LE BARON DESCAPOTABLE 2.5 L 09/86-12/90; LE BARON 2.2 L /2.5 L TURBO; 3.0 L V6 01/89-12/90; VOYAGER I (ES) 3.3 L 08/90-12/90; VOYAGER I (ES) 3.3 L AWD08/90-12/90;

RENAULT: TWINGO (C06_) 1.2 (C067); 1.2 (C066/C068) 05/96-06/97 TWINGO (C06_) 3.3 LAWD 09/96-06/97;

FORD: 09/95-06/97, MERCURY 05/85-12/88, DODGE 05/88-12/90

GI3602A

FEATUERS / CARACTERÍSTICAS: 12V 3.0 BAR 97L/H

REPLACES / REEMPLAZA:

AIRTEX: E10218; **CHRYSLER:** 4075445, 4419617, 4000000; **DELPHI:** FE0201, FE0289; **WALBRO:** 5CA3360

APPLICATION / APLICACIÓN:

SAAB: 9-3 M 2.0 L/2.0L SE TURBO 1998–2002; 9-3 CABRIOLET 2.0 L/2.0L SE TURBO 1998–2003; 9-5 M 2.0 T/2.3 TURBO 1997–; 9-5 ESTATE 2.0 T/2.3T 1998–; 9000 2.0 -16 1989–1993; 9000 HATCHBACK 2.0 -16 CS 1989–1998;

CHRYSLER: LE BARON 1.2L, 2.5L 09/93–06/98; LE BARON CONVERTIBLE 2.5L 09/86–12/93;

HYUNDAI: SONATA 2.0L/3.0L 02/89–12/92



GI3603

FEATUERS / CARACTERÍSTICAS: 12V 3.0 BAR 100L/H

REPLACES / REEMPLAZA:

RENAULT: 77 00 811 048, 77 00 812372, 77 00 829 965, AOR 050, AOU 203; **FORD:** E93Z9H307A; VOLVO: 3462176, AOV081

APPLICATION / APLICACIÓN:

ALFA ROMEO: 155(167) 1.7T.S./1.8T.S SPORT (04/93-04/96) 2.0T.S (03/89-04/94);

FORD: FIESTA FURGON(F3L,F5L) 1.3(L2) 09/91-04/94, FIESTA III (GFJ) 1.1(L2) 1.3(L2) 1.3(Kat.)(L2) 1.4(L2) 03/89-04/94



GI3604

FEATUERS / CARACTERÍSTICAS: 12V 3.0BAR 85L/H 6.2A

REPLACES / REEMPLAZA:

AIRTEX: E10221, E20221; **BOSCH:** 0986 1580 171; **WALBRO:** ERJ197, ERJ237; **CITROËN:** 152546, 152560, 152575, 152594; **PEUGEOT:** 6025304880, 6025315873, 1610077980; **VOLVO:** 30864216; **MD:** 76297; **ERA:** 770016; **ROVER:** ERJ197; **S.I.D.A.T. S.r.l.:** 70014; **VALEO SERVICE DEUTSCHLAND GMBH:** 347203

APPLICATION / APLICACIÓN:

CITROËN: BERLINGO (MF) 1.1 i (MFHDZ, MFHFX) 44Kw 60CV 1124cc, 1.4 i (MFKFX, MFKFW) 55Kw 75CV 1360cc, 1.4 i bivalent (MFKFW) 55Kw 75CV 1360cc, 1.6 16V (MFNFU) 80Kw 109CV 1587cc/ BERLINGO Kasten (M_) 1.1 i (MAHDZ, MBHDZ, MBHFX) 44Kw 60CV 1124cc, 1.4 bivalent 48Kw 65CV 1360cc, 1.4 i (MBKFX, MBKFW) 55Kw 75CV 1360cc/ XSARA PICASSO (N68) 1.6 65Kw 88CV 1587cc, 1.8 16V 85Kw 115CV 1749cc, 2.0 16V 100Kw 136CV 1997cc;

DAEWOO: LANOS (KLAT) 1.4 55Kw 75CV 1349cc, 1.5 63Kw 86CV 1498cc, 1.6 16V 78Kw 106CV 1598cc/ LANOS Stufenheck (KLAT) 1.4 55Kw 75CV 1349cc, 1.5 63Kw 86CV 1498cc, 1.6 16V 78Kw 106CV 1598cc/ LEGANZA (KLAV) 2.0 16V 98Kw 133CV 1998cc, 2.2 16V 100Kw 136CV 2198cc/ NUBIRA (KLAJ) 1.6 16V 78Kw 106CV 1598cc, 2.0 16V 98Kw 133CV 1998cc/ NUBIRA Stufenheck (KLAJ) 1.6 16V 78Kw 106CV 1598cc, 2.0 16V 98Kw 133CV 1998cc/ NUBIRA Wagon (KLAJ) 1.6 16V 78Kw 106CV 1598cc, 2.0 16V 98Kw 133CV 1998cc;

MG:MG ZR 10576Kw 103CV 1396cc, 12086Kw 117CV 1796cc, 160118Kw 160CV 1796cc/ MG ZS 12086Kw 117CV 1796cc, 180130Kw 177CV 2497cc/ MG ZS Hatchback 12086Kw 117CV 1796cc, 180130Kw 177CV 2497cc;

PEUGEOT: 206 CC (2D) 1.6 16V 80Kw 109CV 1587cc, 2.0 S16 100Kw 136CV 1997cc/ 206 Schragheck (2A/C) 1.1 i 44Kw 60CV 1124cc, 1.4 i 55Kw 75CV 1360cc, 1.6 16V 80Kw 109CV 1587cc, 1.6 i 65Kw 89CV 1587cc, 2.0 S16 99Kw 135CV 1997cc, 2.0 S16 100Kw 136CV 1997cc/ 406 (8B) 1.6 65Kw 88CV 1580cc, 1.8 16V 81Kw 110CV 1761cc, 2.0 16V 99Kw 135CV 1997cc, 2.0 Turbo 108Kw 147CV 1998cc, 3.0 24V 140Kw 190CV 2946cc/ 406 Break (8E/F) 1.8 16V 81Kw 110CV 1761cc, 2.0 16V 97Kw 132CV 1998cc, 2.0 Turbo 108Kw 147CV 1998cc, 3.0 24V 140Kw 190CV 2946cc/ 406 Coupe (8C) 2.0 16V 97Kw 132CV 1998cc, 3.0 V6 24V 140Kw 190CV 2946cc/ 607 (9D, 9U) 2.0 100Kw 136CV 1997cc, 2.2 16V 116Kw 158CV 2230cc, 3.0 V6 24V 152Kw 207CV 2946cc/ PARTNER Combispace (5F) 1.1 44Kw 60CV 1124cc, 1.6 16V 80Kw 109CV 1587cc/ PARTNER Kasten (5) 1.1 44Kw 60CV 1124cc, 1.4 55Kw 75CV 1360cc;

RENAULT: ESPACE III (JE0_) 2.0 102Kw 139CV 1998cc, 2.0 (JE0A) 84Kw 114CV 1998cc, 2.0 16V (JE0N, JE0L, JE02) 103Kw 140CV 1998cc, 3.0 (JE0D) 123Kw 167CV 2963cc, 3.0 V6 24V (JE0G, JE0R) 140Kw 190CV 2946cc;

ROVER: 200 (RF) 21144Kw 60CV 1119cc, 214 i 55Kw 75CV 1396cc, 214 Si 76Kw 103CV 1396cc, 216 Si 82Kw 112CV 1588cc, 218 K Vi 107Kw 146CV 1796cc/ 25 (RF) 1.4 16V 62Kw 84CV 1396cc, 1.4 16V 76Kw 103CV 1396cc, 1.6 16V 80Kw 109CV 1588cc, 1.8 16V 85Kw 116CV 1796cc, 1.8 16V 107Kw 146CV 1796cc/ 400 (RT) 414 Si 76Kw 103CV 1396cc, 420 Si Lux 100Kw 136CV 1994cc/ 400 Hatchback (RT) 414 Si 76Kw 103CV 1396cc, 416 Si 82Kw 112CV 1588cc, 420 Si Lux 100Kw 136CV 1994cc/ 400 Tourer (XW) 1.8 i 107Kw 146CV 1796cc, 2.0 i 100Kw 136CV 1994cc/ 45 (RT) 1.4 76Kw 103CV 1396cc, 1.6 80Kw 109CV 1588cc, 1.8 86Kw 117CV 1796cc, 2.0 V6 110Kw 150CV 1997cc/ 45 Stufenheck (RT) 1.4 76Kw 103CV 1396cc, 1.6 80Kw 109CV 1588cc, 1.8 86Kw 117CV 1796cc, 2.0 V6 110Kw 150CV 1997cc/ CABRIOLET (XW) 216 1.6i 16V 82Kw 111CV 1588cc/ COUPE 1.6 16 V 82Kw 111CV 1588cc, 1.8 16 V 107Kw 145CV 1795cc

GI3604A

FEATUERS / CARACTERÍSTICAS: 12V 1.2 BAR 85L/H

REPLACES / REEMPLAZA:

AIRTEX: E10228, E10521; **MARELLI:** MSS0802; **WALBRO:** 5CA206; **CHRYSLER:** FIAT: 7747117-46473397; **CHEVROLET:** 25115097, 25115462, 25116588, 25167089

APPLICATION / APLICACIÓN:

CITROËN: C15 (VD_) 1.4L 01/92–12/96, SAXO (S0, S1) 1.0L /1.1L 05/96–12/96, JUMPY (U6U) 1.6 (->T 7846) 10/95->, JUMPY FURGON 1.6 L (->T 7846) 10/95->;

FIAT: CINQUECENTO (170) 1.1 SPORTLNG (170AH) 10/94-01/98, PANDA (141A_) 900 (ECE 2 ECO (TWC)) 04/92–12/96, PANDA (141A_) 1100 TREKKLNG 4X4 (ECO (TWC)) 01/93->, PANDA (141A_) 1100 (ECO (TWC)) 01/93–12/99, PANDA (141A_) 1100 (ECE 2) 02/95–09/03, PANDA (141A_) 1100 4X4 (ECE 2) 02/95->, PUNTO (176) 55 1.1 (SPL) 09/93-09/99, PUNTO (176) 60 1.2 (SPL) 01/94–09/99, PUNTO (176) 60 1.2 03/94–04/97, PUNTO DESCAPOTABLE (176C) 60 1.2 (SPL) 04/94–04/97, PUNTO VAN (176L) 1.1 (ECE 2) 04/96-02/00, SEICENTO (187) 0.9L/1.1L 01/98->, PANDA VAN 1000 L.E 12/00->;

LANCIA: Y (840A) 1.2 L/1.1L 03/96–06/00;

PEUGEOT: 106 I (1A, 1C) 1.0L /1.1L/1.4L 09/91-04/96 605 (6B) 2.0 (SPL) 06/89–09/99, EXPERT (224) 1.6 L 02/96–12/00, 106 II (1) 1.0 L (->T O 07328) 05/96-12/97;

RENAULT: CLIO I (B/C57_, 5/357_) 1.2L/1.1L/1.4L 05/90–01/93





G13605

FEATURES / CARACTERÍSTICAS: 12V 0.12 BAR 130-170L/H

REPLACES / REEMPLAZA:

AC DELCO: EP336, EP383, EP384; **AIRTEX**: E3268, E3791, E8224, E3268; **DELPHI**: FE0003, FE0116; KEM: EFP8186; BOSCH; OPEL: 815008; VOLVO: 1389436-5, 3514934-3

APPLICATION / APLICACIÓN:

VOLVO: 760 (704, 764) 2.8 (764)/2.3 TURBO 01/87--12/87, 940 (944) 2.3 TURBO 08/90-07/94, 740 (744) 2.3 TURBO/2.0L 08/86-07/89, 760 (704, 764) 2.3 TURBO (704) 08/84-10/88, 760, KOMBI (704, 765) 2.3 TURBO 08/84-07/89, 740, KOMBI (745) 2, 3 08/85--07/88, 940, KOMBI (945) 2.3 TURBO 08/90--07/94;

BUICK: 2.0L/2.5L 02/82--12/85, CADILLAC: 2.0L/4.1L/6.0L 02/80-12/85;

CHEVROLET: BLAZER 2.8L 09/82--12/89; CAPRICE 5.7L 01/83-01/90



G13606

FEATURES / CARACTERÍSTICAS: 12V 0.12 BAR 130-170L/H

REPLACES / REEMPLAZA:

AC DELCO: EP382, EP386, EP387; **AIRTEX**: E3902; **WALBRO**: 5CA401; CARTER: P74000; **CHEVROLET**: 6472311, 6472370, 6772374, 472377, 6472421, 6472526, 6472763, 25115097, 25115462, 25117506, 25166801, 25168719

APPLICATION / APLICACIÓN:

CHEVROLET: CAMARO '81 5.0 L 01/88--12/92; CAPRICE '83 5.7 L 01/89--01/90; BLAZER S '82 2.8 L V6 01/86--12/89;

BUICK: 01/82--12/88;

CADILLAC: 01/88--12/92;

CHEVY: 01/82--12/96;

GMC: 01/85--12/96;

OLDSMOBILE: 01/81--12/94;

PONTIAC: 01/82--12/95;

GM: PICKUP SIERRA 01/89--12/95, VAN RAILY 01/94--12/95



G13607

FEATURES / CARACTERÍSTICAS: 12V 3.0 BAR 100L/H

REPLACES / REEMPLAZA:

AC DELCO: EP189, EP207, EP236, EP241, P243, EP244, EP277, EP329, EP367, EP379, EP380; **AIRTEX**: E3210, E3212, E3240, E3270, E3271, E3307, E3367, E3904, E3906, E3931, E3933; **DELPHI**: FE0039, FE0040, FE0102, FE0112, FE0324, FE0050, FE0110, FE0111; VOLVO: 3507736-1, 3531165-3; **GM**: 25117454; **WALBRO**: 5CA231, 5CA400

APPLICATION / APLICACIÓN:

CHEVROLET: CORVETTE 97 5.7 L 01/97--09/04, CORVETTE '97 5.7 L Z 06 08/00--09/04, CORVETTE 83 5, 7 01/92--01/97, CORVETTE 97 DESCAPOTABLE 5, 7 09/97--09/04;

PONTIAC: BONNEVILLE 3.8L 09/96--09/99;

OLDSMOBILE: LSS 3.8L 09/96--09/99;

BUICK: PARK AVENUE 3.8L 09/96--



G13607A

FEATURES / CARACTERÍSTICAS: 12V 3.0 BAR 100L/H

REPLACES / REEMPLAZA:

AC DELCO: EP375, EP376, EP378; **DELPHI**: FE0110, FE0111, FE113; KEM: EFP264; **VDO**: 405-058-005-0117; **WALBRO**: 5CA405

APPLICATION / APLICACIÓN:

CADILLAC: ALLANTE V8 4.5L 06/89--12/92



GI3607B

FEATURES / CARACTERÍSTICAS: 12V 3.0 BAR 100L/H

REPLACES / REEMPLAZA:

AC DELCO: EP377, EP240; **AIRTEX**: E3240, E3265, E3270, E3212, E3904, E3906; **WALBRO**: 5CA421; **GM**: 25116525

APPLICATION / APLICACIÓN:

BMW: 3 (E30) 316 I/318I/318 LS/316 I/1.8L (TANK 55) 03/88--06/91;
CITROËN: ZX (N2) 1.6 L/1.9 L/2.0L 16V (HLGH PRESSURE) 03/91--06/97; ZX BREAK (N2) 1.6 L/1.8 L (HLGH PRESSURE) 10/93--10/97;
FIAT: TEMPRA (159) 1.8L/2.0L I.E. 03/92--08/96; TEMPRA S.W. (159) 1.8L/2.0L 03/92--12/93;
FORD: FIESTA III (GFJ) 1.4L/1.6L 03/89--12/95; FIESTA III (GFJ) 1.4 L/1.6L 03/89--12/95;
LANCIA: DEDRA (835) 2.0L 11/90--07/94;
PEUGEOT: 306 FASTBACK (7A, 7C, N3, N5) 1.4 L/1.6L/1.8L/2.0L 05/93--04/97; 306 DESCAPOTABLE (7D, N3, N5) 1.6L/1.8L/2.0L 03/94--04/97 306 (7B, N3, N5) 1.4 SL 1.8 ST 1.6 SR 2.0 S16 06/94--04/97; 306 BREAK (7E, N3, N5) 1.4 L/1.8L 03/97--04/97;
LAND ROVER: RANGE ROVER I 3.5 L VOGUE /3.9L CAT 3.9 VOGUE SEL/ 4.3L VOGUE LSE 08/81--09/90; DISCOVERY II (LJ, LT) 3.9L/4.0L/ 2.0 L 06/94--11/98;
CHEVROLET: LUMINA APV 3.1L/3.8L 01/94--07/96;
PONTIAC: TRANS SPORT '89 3.8L 01/92--12/95; BONNEVILLE 3.8 LV6 09/86--12/89;
OLDSMOBILE: CUTLASS SUPREME 2.8L/3.1L/3.4L 09/88-->;
CHEVROLET: BLAZER '94 4.3 V6 (2/4 DOORS) 01/95--01/95; BLAZER S '82 4.3 V6 01/92--08/94;
VOLVO: 740 (744) 2.3 (OE Nº 3531165-3) 01/90--12/90;
CADILLAC: SEVILLE 4.6L/439L 02/93--11/94;
PONTIAC: GRAND AM 2.3L/3.1L 02/93--11/95;
BUICK: BARETTA 2.2L/2.3L/3.1L 01/93--12/95;
GMC: G3500 7.4L 06/94--12/97



GI3608

FEATURES / CARACTERÍSTICAS: 12V 0.12 BAR 140L/H

REPLACES / REEMPLAZA:

AC DELCO: EP240; **DELPHI**: FE0009, FE0011

APPLICATION / APLICACIÓN:

AUDI; **BUICK**; **CADILAC**; **CHEVROLET**; **PONTIAC**; **FORD**



GI3608A

FEATURES / CARACTERÍSTICAS: 12V 0.12 BAR 110L/H

REPLACES / REEMPLAZA:

AC DELCO: EP106, EP111, EP254, EP297, EP301, EP303, EP193; **AIRTEX**: E2003, E2008, E3024, E3106, E3900, E3901, E7359, E8237, E8371; **DELPHI**: FE0008, FE0046, FE0068, FE0069, FE0070, FE0314, FE0315, EFP2008, EFP7359, EFP8237, EFP8381, EFP95; KEM: 1612.1.121.49 4, 17708-SE0-013, 17708-SE0-020, 17708-SE0-023; **BMW**: 17708-SF1-A06, 17708-SF1-S08; **FORD**: 17708-SE0-023, 17708-SF1-A06, 17708-SF1-S06, E6UZ-9H307A, E6UZ-9H307G, E6UZ-9H307H, E6UZ-9H307J, E7TZ-9H307A, E8UZ-9H307F, E8UZ-9H307E, E8UZ-9H307G, E9UZ-9H307C, F0UZ-91307A; VOLVO: 3501928-0, 3507436-8

APPLICATION / APLICACIÓN:

VOLVO: 940 II (944) 2.0L/2.3L TURBO 08/94--10/98; 940 II RANCHERA FAMILIAR (945) 2.0L/2.3L TURBO 08/94--10/98; 760 (704, 764) 2.8 (704/764) 08/81--07/88; 760 KOMBI (704, 765) 2.8 (765) 05/86--08/91; 940 KOMBI (945) 2.0 TURBO 01/91-->;
CADILLAC: 5.7L 06/79--12/80;
CHEVROLET: 2.5L 01/82--04/83;
BUICK: 2.5L 03/82--09/85;
OLDSMOBILE: 2.5L 04/82--06/85;
PONTIAC: 2.5L 03/82--12/84;
MERCURY: 3.8l 03/84--12/86;
FORD: 3.8l 03/84--12/86



GI3608B

FEATURES / CARACTERÍSTICAS: 12V 0.12 BAR 110L/H

REPLACES / REEMPLAZA:

DELPHI: FE20001-12B1; KEM: EFP2003, EFP2035

APPLICATION / APLICACIÓN:

CITROËN: BX (XB-) 14 E/16E/19E/16/19/11/15 (LOW PRESSURE) 10/82--06/88;
HONDA: ACCORD III (CA4, CA5) 1.6 L/2.0L/ 11/85--12/89; PRELUDE III (BA) 2.0 L EX 16V (BA4) CAT 11/88--01/92; PRELUDE III (BA) 2.0 (BA4) 08/87--01/92; ACCORD III AERODECK (CA5) 2.0 EX (CA5) 11/85--05/89;
PEUGEOT: 205 II (20A/C) 1.1L/1.4L/1.6L (LOW PRESSURE) 10/87--10/90; 305 II (581M) 1.6 (LOW PRESSURE) 11/86--12/88; 309 I (10C, 10A) 1.1L/1.3L/1.4L/1.6L/1.9L/1.9GTL (LOW PRESSURE) 10/85--07/89; 505 (551A) 1.8L/2.0L (LOW PRESSURE) 06/81--10/85; 309 II (3C, 3A) 1.1L/1.4L/1.6L/1.9L (LOW PRESSURE) 08/90--12/93; 505 BREAK (551D) 2.0 (LOW PRESSURE) 08/83--12/85;
BMW: 3 (E21) 320i, 320 L 09/77--08/82;
VOLVO: 940 II (944) 2.0L/2.3L TURBO 08/94--10/98; 940 II RANCHERA FAMILIAR (945) 2.0L/2.3L TURBO 08/94--10/98; 760 (704, 764) 2.8L 05/86--08/91; 760 KOMBI (704, 765) 2.8L 05/86--08/91; 940 KOMBI (945) 2.0 TURBO 01/91--07/95; 240 (P242, P244) 2.0L/2.1L/2.3L 08/74--07/80; 240 KOMBI (P245) 2.0L/2.1L/2.3L 08/75--07/80; 260 RANCHERA FAMILIAR (P265) 2.7L/2.8L 10/78--07/82;
HONDA: ACCORD III (CA4, CA5) 1.6 L/2.0L (CA4/5) 11/85--12/89; PRELUDE III (BA) 2.0 L EX 16V (BA4) CAT 11/88--01/92; ACCORD III AERODECK (CA5) 2.0 EX 10/87--12/89;
PEUGEOT: 205 II (20A/C) 1.1L/1.4L/1.6L (LOW PRESSURE) 10/87--10/90; 305 II (581M) 1.6 (LOW PRESSURE) 11/86--12/88; 309 I (10C, 10A) 1.1L/1.3L/1.4L/1.6L/1.9L/1.9GTL (LOW PRESSURE) 10/85--07/89; 309 I (10C, 10A) 1.6 (LOW PRESSURE) 10/85--07/89; 505 (551A) 1.8 (LOW PRESSURE) 01/82--10/85; 505 (551A) 2.0 (LOW PRESSURE) 09/85--09/91; 309 II (3C, 3A) 1.1L/1.4L/1.6L/1.9GTL (LOW PRESSURE) 08/90--12/93; 505 BREAK (551D) 2.0 (LOW PRESSURE) 08/83--12/85;
MERCURY: 08/84--12/86



GI3608C

FEATURES / CARACTERÍSTICAS: 12V 0.12 BAR 110 L/H

REPLACES / REEMPLAZA:

VOLVO: 1276330, 271119-0, 1276330-6

APPLICATION / APLICACIÓN:

SAAB: 900 2.0L 86-90;

VOLVO: 240 2.0L/2.3L 82-93, 740 2.0L/2.3L 88-91, 760 2.0L/2.3L 85-91



GI3609

FEATURES / CARACTERÍSTICAS: 12V 3.0BAR 105L/H 6.2A

REPLACES / REEMPLAZA:

BOSCH: 0 580 464 001; **WALBRO:** TTP387; **MD:** 76397; **ERA:** 770119; **AIRTEX PRODUCTS S.A.:** E10231; **CITROËN:** 1525Q8; **PEUGEOT:** 1525F8, 1525N7, 1525N8, 1525S9, 1525Y1; **ROBERT BOSCH GMBH:** 0 580 464 001; **S.I.D.A.T. S.r.l.:** 70175; **TI Automotive Fuel Systems:** TTP297; **VALEO SERVICE DEUTSCHLAND GMBH:** 347208

APPLICATION / APLICACIÓN:

CITROËN: BERLINGO 1.1L/ 1.4L 07/96>, XSARA PICASSO (N68) 2000 1.6L/ 1.8L 03/01>, C5 BREAK 1.8L/ 2.0L/ 3.0L 06/01>, EVASION (22, U6) 2.0 16V 100Kw 136CV 1997cc/ JUMPY (U6U) 2.0 i 16V 102Kw 138CV 1997cc;

LANCIA: ZETA (220) 2.0 16V (220AQ5) 100Kw 136CV 1997cc;

PEUGEOT: PARTNER 1.3L 06/96>, 206 SW (2E/ K) 1.1L/ 1.4L/ 1.6L/ 2.0L 07/02>, 307 (3A/C) 1.4L/ 1.6L/ 2.0L 08/00>, 406 1.8L/ 2.0L/ 2.2L/ 3.0L 00-04, 607 (9D, 9U) 2.0L/ 2.2L/ 3.0L 02/00>, 307 (3A/C) 1.4 55KW 75CV 1360CC, 1.4 16V 65KW 88CV 1360CC, 1.6 16V 80KW 109CV 1587CC, 2.0 16V 100KW 136CV 1997CC/ 307 BREAK (3E) 1.4 16V 65KW 88CV 1360CC, 2.0 100KW 136CV 1997CC/ 307 CC (3B)2.0 16V 100KW 136CV 1997CC, 2.0 16V 130KW 177CV 1997CC/ 307 SW (3H) 1.4 16V 65KW 88CV 1360CC, 1.6 16V 80KW 109CV 1587CC, 2.0 16V 100KW 136CV 1997CC/ 806 (221) 2.0 16V 100KW 136CV 1997CC/ 807 (E) 2.0 100KW 136CV 1997CC, 2.2 116KW 158CV 2230CC, 3.0 V6 150KW 204CV 2946CC/ EXPERT (224) 2.0 100KW 136CV 1997CC/ EXPERT KASTEN (222) 2.0 100KW 136CV 1997CC;

RENAULT: CLIO II (BB0/1/2_, CB0/1/2_) 1.2 (BB0A, BB0F, BB10, BB1K, BB28, BB2D, BB2H, CB0A...) 43KW 58CV 1149CC, 1.4 16V (B/CB0L) 70KW 95CV 1390CC, 1.4 16V (B/CB0P) 72KW 98CV 1390CC, 1.6 (B/CB0D) 66KW 90CV 1598CC, 1.6 16V (BB01, BB0H, BB0T, BB14, BB1D, BB1R, BB2KL...) 79KW 107CV 1598CC/ CLIO II KASTEN (SB0/1/2_) 1.1 (SB0A, SB0F, SB1K, SB2D) 43KW 58CV 1149CC/ THALIA I (LB0/1/2_) 1.4 55KW 75CV 1390CC, 1.4 16V 72KW 98CV 1390CC, 1.6 16V 79KW 107CV 1598CC/ TWINGO I (C06_) 1.2 (C066, C068) 43KW 58CV 1149CC, 1.2 (C067) 40KW 54CV 1149CC/ TWINGO I KASTEN (S06_) 1.2 (S066, S068) 43KW 58CV 1149CC.



GI3609B

FEATURES / CARACTERÍSTICAS: 12V 3.0BAR 105L/H 6.2A

REPLACES / REEMPLAZA:

MD: 76359; **ERA:** 770087; **DAEWOO:** 96 350 078, 96 494 976; **MARWAL:** 77 001 00; **PIERBURG:** 7.00468.50.0; **WALBRO:** TTP359, TTP456, TTP490

APPLICATION / APLICACIÓN:

CITROËN: C5; **DAEWOO:** ESPERO, NEXIA; **FIAT:** PUNTO, SEICENTO; **LANCIA:** Y; **RENAULT:** CLIO, TWINGO



GI3610

FEATURES / CARACTERÍSTICAS: 12V 3.0 BAR 100 L/H

REPLACES / REEMPLAZA:

AC DELCO: EP242, EP268, EP270, EP306, EP330, EP381; **AIRTEX:** E3211, E3313; **DELPHI:** FE0025, FE0041, FE0047, FE0114; **ALFA ROMEO:** 60609932; **FIAT:** 5992146, 7778975; **GM:** 251 17454, 251 63 328, 251 63 464; **VOLVO:** 35311653

APPLICATION / APLICACIÓN:

CHEVROLET;

OLDSMOBILE;

DAEWOO;

BUICK: 03/84>12/87



GI3611

FEATURES / CARACTERÍSTICAS: 12V 0.12 BAR 140 L/H

REPLACES / REEMPLAZA:

-

APPLICATION / APLICACIÓN:

BUICK: 85-86;

CADILLAC: 85-86;

CHEVROLET: 85-86;

OLDSMOBILE: 85-86;

PONTIAC: 85-86



GI3613

FEATURES / CARACTERÍSTICAS: 12V 3.0 BAR 100 L/H

REPLACES / REEMPLAZA:

BOSCH: 0580305001; **MARELLI:** MAM214; **WALBRO:** AM-09-ST, ESS273, ESS274, ESS291, ESS382, ESS275, MSS070, MSS166; **DAEWOO:** AM-09-ST; **FIAT:** 7769932, 46427664, 46427686-46831950, 77500715-46831949

APPLICATION / APLICACIÓN:

FIAT: PUNTO (176) 75 1.2 (MPL) 01/94--01/98, BARCHETTA (183) 1.8 16V (MPL) 04/95>05/98; **LANCIA:** Y (840A) 1.2 16V (840AD) (MPL) 04/97>06/00; **CITROËN:** XANTIA (X1) 1.6L/ 1.8L/ 2.0L 16V; **PEUGEOT:** 806 (221) 1.8L/ 2.0L 06/94>12/98; **RENAULT:** CLIO I (B/ C57_ , 5/ 357_) 1.2L/ 1.4L/ 1.8L 16V 05/90>01/93



GI3613A

FEATURES / CARACTERÍSTICAS: 12V 1.2BAR 100L/H 3.2A

REPLACES / REEMPLAZA:

MARELLI: 217750715000, 217736883000, MM0702; **WALBRO:** ESS290, ESS382, ESS452; **FIAT:** 46402826, 46474140, 46474141, 46831949, 7747117, 46473397; **PEUGEOT:** 145505, 152529, 152530, 152543, 96107921; **MD:** 76296; **ERA:** 770010; **BOSCH:** 0 986 580 350; **WALBRO:** ESS273, ESS382.

APPLICATION / APLICACIÓN:

CITROËN: C15 1.4L 05/ 91-- 12/ 96, JUMPY, SAXO;
FIAT: CINQUECENTO, PANDA, PUNTO, SEICENTO;
LANCIA: DEDRA, Y;
PEUGEOT: 106, 605 (6B) 2.0L 06/ 89-- 09/ 99;
VOLVO: S40 I (VS) 1.8L/1.9L/2.0L 95--00, V40 ESTATE (VW) 1.8L/1.9L/2.0L 95--00



GI3615

FEATURES / CARACTERÍSTICAS: 12V 3.0 BAR 165L/H

REPLACES / REEMPLAZA:

AIRTEX: E2318, E2386

APPLICATION / APLICACIÓN:

FORD: EXCURSION 5.4L 330V8 00-05 , F250 SUPER DUTY 5.4L 330V8 00-05, F-350 SUPER 5.4L 330V8 99--04, F-450 SUPER 5.4L 330V8 99--04,



GI3616

FEATURES / CARACTERÍSTICAS: 12V 3.0 BAR 80L/H

REPLACES / REEMPLAZA:

AIRTEX: E10221; **BOSCH:** 0986580171, 0986580172, 0986580175, 0986580176, 0986580177; **DELPHI:** FE0285; **WALBRO:** ERJ415; **CHRYSLER:** 4798947

APPLICATION / APLICACIÓN:

DODGE: 3.3L 01/91--12/07;
OTOWNQ COOUNTRY: 3.8L 02/95;
CHRYSLER: VOYAGER I (ES) 2.5 L/3.0L/3.3L 01/91--12/93



GI3616A

FEATURES / CARACTERÍSTICAS: 12V 4.5 BAR 85L/H

REPLACES / REEMPLAZA:

WALBRO: ERJ415

APPLICATION / APLICACIÓN:

FORD;
DODGE: 3.3L 01/92--12/97;
CHRYSLER: 01/92--12/97



GI3617

FEATURES / CARACTERÍSTICAS: 12V 3.0 BAR 100L/H

REPLACES / REEMPLAZA:

DELPHI: BCD00101, **GM:** 0.64.34.02

APPLICATION / APLICACIÓN:

GM: MONZA/KADETT 1.0L/1.3L 91-96, IPANEMA EFI 95, S-10 EFI



GI3617G // NEW //

FEATURES / CARACTERÍSTICAS: 12V 3.0 BAR 100L/H - Version only Gasoline

REPLACES / REEMPLAZA:

Delphi: BCD00101; **Weber:** WB101; **GM:** 06443268, 06443402; **Bosch:** 0 580 464 070

APPLICATION / APLICACIÓN:

CHEVROLET: Ascona B saloon 2.0/2.4 1979>1981, Commodore C saloon/estate 2.5 1981>1982, Kadett C coupe 1.9/2.0 1975>1979, Monza 2.0/2.2/2.5 1981>1986 (just gasoline)



G13618

FEATURES / CARACTERÍSTICAS: 13.5V 0 BAR 174L/H

REPLACES / REEMPLAZA:

-

APPLICATION / APLICACIÓN:

CASE/IH(MXM SERIES): MXM 120,130,135,140,150 MXM 155,165,175,180,190

FIAT (M SERIES): M100,115,135,160

FIAT (TM SERIES): TM110,115,120,125,130,135 140,150,155,165,175,000,000

FIAT (TS SERIES): TS 90,100,110,115

FORD NEW HOLLAND: 10 SERIES 5610S,6610S 6810S,7010S,7610S,8010S

BACKHOE: 60 SERIES,8160,8260,8360, 555E,575E,655E,675E,LB75,LB110,LB115



G13619

FEATURES / CARACTERÍSTICAS: 12V 1.0 BAR 70L/H

REPLACES / REEMPLAZA:

DELPHI: FE8152; SUZUKI: 15110-60BT0

APPLICATION / APLICACIÓN:

SUZUKI: SWIFT 1.0G 10A, 1.0L/1.3L



G13620

FEATURES / CARACTERÍSTICAS: 13.5V 3.5 BAR 100L/H

REPLACES / REEMPLAZA:

-

APPLICATION / APLICACIÓN:

"30 KVA Perkins engine Caterpillar PF300C, CP323C, CS323C, PS360C, Compactors, M313C, Excavators, TH210, Telehandlers all with 3054C, Engines"



G13621

FEATURES / CARACTERÍSTICAS: 13.5V 3.5 BAR 100L/H

REPLACES / REEMPLAZA:

TTP552 01

APPLICATION / APLICACIÓN:

PEUGEOT: 405, 206



G13622

FEATURES / CARACTERÍSTICAS: 12V 3.0 BAR 130L/H

REPLACES / REEMPLAZA:

WALBRO; RENAULT

APPLICATION / APLICACIÓN:

RENAULT



G13623

FEATURES / CARACTERÍSTICAS:

REPLACES / REEMPLAZA:

AIRTEX: E7230

APPLICATION / APLICACIÓN:

DODGE: RAM 2500 / 3500 TRUCK L6-5.9L 04/02



G13801

FEATURES / CARACTERÍSTICAS: 12V 3.0 BAR 100L/H

REPLACES / REEMPLAZA:

ISUZU: 5-86202-235-0, 8-94384-528-1, 8-94479-418-1, 8-97041-876-1; MAZDA: B3C713350, B3E713350, B3E713350A, B3E713352B;

VDO: X10-240-016-001

APPLICATION / APLICACIÓN:

TOYOTA: 04/87-12/02



GI3802

FEATURES / CARACTERÍSTICAS: 12V 3.0BAR 100L/H 5.5A

REPLACES / REEMPLAZA:

AC DELCO: EP432, EP482, EP487; **AIRTEX**: E2068, E8335; **BOSCH**: 0 580 453 481, 0 581 454 001, 0 580 453 408, 0 580 453 423, 0 580 453 427, 0 580 453 455, 0 580 453 460, 0 580 453 465, 0 580 453 470, 0 580 453 477, 0 580 453 485, 0 580 453 497, 0 580 454 001, 0 580 454 093, 0 580 454 094, 0 986 580 962, 580453407, 580453432, 580453492, F 01R 00R 004; **DELPHI**: FE0150; **WALBRO**: GCA171, GCA703, GCA705, GCA711; **CHEVROLET**: 93288811, 93238459, 93249371, 93274454; **FORD**: F75Z-9A407HA, F7UZ-9A407EA, F7UZ-9H407EB, F7UZ-9H407FB, F87Z-9H307BA, F87Z-9H307CA, F8XZ-9H307EB, F1DUA3A; **JEEP**: 5003861AA, 5003869AA; **MITSUBISHI**: MR391856; **OPEL**: 815039, 9120218, 9200109, 815037, 815037, 9120218, 9128644; **VDO**: 993-784-025; **TOYOTA**: 23221-03040, 23221-21020; **MD**: 76416; **ERA**: 770162; **SIDAT**: 70408; **ALFA ROMEO**: 464806070, 606519690, 60812839; **FIAT**: 46480607, 464806070, 606519690, 60812839; **GENERAL MOTORS**: 93238459, 93249371; **GMC**: 93238459; **HONDA**: 17040S01A31, 17040S04G31, 17040S04G41, 17040ST7A32, 17040ST7A33, 17040SV4A31; **HYUNDAI**: 311111R500, 3111122000, 3111122050, 3111125000, 3111128150, 3111128300, 3111137150, 3111137200, 3111137300, 311113L000; **IVECO**: 7789626; **JAGUAR**: OJLM12159; **LANCIA**: 606519690; **NISSAN**: 1704059G05; **PIAGGIO**: AP8106385; **S.I.D.A.T. S.r.l.**: 70408; **VALEO SERVICE DEUTSCHLAND GMBH**: 347251; **VAUXHALL**: 815037; **WEBER**: WB011; **MAGNETI MARELLI**: MM103

APPLICATION / APLICACIÓN:

HONDA: CIVIC IV (EG, EH) 1.5 L/1.6L 10/91--11/95, CIVIC IV COUPE (EJ) 1.5 L/1.6L 01/94--11/95, CR-V I (RD) 2.0 16V (RD1/RD3) 01/00->, PRELUDE V (BB) 2.2 16V (BB6/BB8) 10/96--12/01, S2000 (AP) 2.0 06/99->, **ACCORD**, CIVIC, CRX, PRELUDE, SHUTTLE;
ISUZU: TROOPER 3.5 V6 24V 04/00->, TROOPER TERRENO, ABIERTA 3.5 V6 24V 04/00->; **NISSAN**: MAXIMA QX (A33) 3.0 V6 24V 03/00->;
SUBARU: OUTBACK (BE, BH) 2.5 10/00->; **JEEP**: CHEROKEE (XJ) 2.5 L/4.0L 01/94--12/96; **INFINITI**: I30 3.0 01/00-12/01; **AC DELCO**: CL 2001; **FORD**: PROBE 01/93-12/94, MIATA 04/90; **MAZDA**: MX-6 04/91-12/97, 626 04/94-12/97, 323 C, 323 F, 323 P, 323 S, 626, MPV, MX-6; **LADA**: FORMA 06/94, 111, 112, NADESCHDA, NIVA, NOVA, SAMARA; **KIA**: SEPHIA 01/95-12/97, SPORTAGE 06/95-05/97, MAGENTIS, OPIRUS, SPORTAGE;
ALFA ROMEO: 145, 146, 155, GTV; **CHRYSLER**: NEON; **DAIMLER**; **DODGE**: NEON; **FIAT**: BRAVO, COUPE, MAREA; **HYUNDAI**: ACCENT, GETZ, MATRIX, SANTA FÉ, TRAJET, XG; **JAGUAR**: XJ, XK 8; **LANCIA**: KAPPA; **MITSUBISHI**: L 300, LANCER, PAJERO, SIGMA; **NISSAN**: MICRA, PRIMERA, SERENA, TERRANO, VANETTE CARGO; **OPEL**: ASTRA, COMBO, CORSA, OMEGA, TIGRA, VECTRA, ZAFIRA; **VAUXHALL**: ASTRA, ASTRAMAN, COMBO, CORSA, OMEGA, TIGRA, VECTRA, ZAFIRA; **VOLVO**: 850, C70, S40, S70, V40, V70



GI3802A

FEATURES / CARACTERÍSTICAS: 12V 4.0 BAR 140L/H

REPLACES / REEMPLAZA:

BOSCH: 0 580 453 481

APPLICATION / APLICACIÓN:

FIAT: DOBLO 1.8 8V MPI 01>, MAREA 1.8/2.0/2.4MPI ALL, PALIO, PALIO WEEKEND, SIENA, STRADA ALL MPI 01>; **FORD**: COURIER ALL MPI 03>, ECOSPORT 1.63/2.0 MPI 02>, FIESTA 1.0/1.6MPI 02>; **GM**: ASTRA, VECTRA ALL MPI 98>, BLAZER 2.2/2.4 MPI 99>, BLAZER 2.2 MPI 99>, CELTA 1.0 MPFI 10/02--12/02, CELTA 1.4 MPFI 10/02--03/06, CORSA/SEDAN 1.0 8V/16V MPI 99>, GRAND BLAZER 4.1 ALL, S10 2.2/2.4 MPI 99>, SILVERADO 4.1 ALL, ZAFIRA 2.0 MPFI 04/01>; **VW**: FOX, POLO 1.0/1.6MPFI 01>, GOL/ PARATI/ SAVEIRO ALL MPI 00>



GI3803

FEATURES / CARACTERÍSTICAS: 12V 3.0 BAR 100L/H

REPLACES / REEMPLAZA:

AC DELCO: EP389, EP391, EP392, EP404, EP406, EP443; **AIRTEX**: E8229; **BOSCH**: 0 580 453 411, 0 580 453 412, 0 580 453 455, 0 580 453 460, 0 580 453 461, 0 580 453 465, 0 580 453 407, 0 580 453 408, 0 580 453 417, 0 580 453 449, 0 580 453 453, 0 580 453 477, 0 580 453 483; **HYUNDAI**: 31111-22050, 31111-23300, 31111-28100, 31111-28150, 31111-28300, 31111-37150, 3111-37200, 31111-37250, 31111-37300; **MAZDA**: B61P13350B, B61P13ZE0, B6BF1335Z, B6BG1335Z, B6DA13350, BPE813350, BPE81335Z; **NISSAN**: 17042-31008, 17040-4B000, 17040-8B000, 17040-8B005, 17042-0W000, 17042-0W005, 17042-2B500, 17042-31U00, 17042-4B000, 17042-8B000

APPLICATION / APLICACIÓN:

MAZDA: 626 V (GF) 2.0 05/97->;
CHRYSLER: STRATUS (JA) 2.5 LX V6 (2 DOORS) 01/00--04/01;
FIAT: COUPE (FA/175) 2.0 L/1.8L 04/94--08/96;
HONDA: LEGEND II COUPE (KA8) 3.2 L 24V 01/91--02/96, ACCORD V AERODECK (CE) 2.2 L ES (CE1) 09/93--02/98;
NISSAN: PRIMERA (P10) 1.6 01/95--01/96, MAXIMA QX (A32) 2.0 02/95--08/00, PICK UP (D21) 2.4 L 04/92--02/98;
OPEL: MONTEREY A (UBS_) 3.2 (UBS25_) 01/94--07/98;
SUZUKI: SWIFT II FASTBACK (EA, MA) 1.3 GTL (SF413/AA34) 01/95--05/01;
HYUNDAI: ACCENT (X-3) 1.5 L 12V 10/94--01/00, LANTRA I (J-1) 1.6 L/1.8 L 10/90--11/95;
KIA: SEPHIA SEDAN (FA) 1.8 L 16V 01/95->



GI3803E

FEATURES / CARACTERÍSTICAS: 12V 3.0 BAR 85L/H

REPLACES / REEMPLAZA:

BOSCH: 580453449, **FIAT**: 46443874, **TOYOTA**: 23221-46010, 23220-03020

APPLICATION / APLICACIÓN:

FORD;
VOLVO;
CHEVROLET

GI3804

FEATURES / CARACTERÍSTICAS: 12V 3.0 BAR 100L/H

REPLACES / REEMPLAZA:

AC DELCO: EP477, EP494; **GM**: 30010245; **AIRTEX**: E2111; **DELPHI**: FE0318, FE0189, FE0204; **WALBRO**: GCA355; **MITSUBISHI**: UC-T30Z; **SUZUKI**: 15100-57B01, 15100-80C01, 15100-80C02, 15100-57B20, 15100-61A02

APPLICATION / APLICACIÓN:

MAZDA: 1.8L 04/99-12/05, GEO PRIZM 1.6L 01/89-12/95;

FORD: 1.3L 03/84-12/92;

SUZUKI: SAMURAI (SJ) 1.3(SJ413) 11/88->



GI3805

FEATURES / CARACTERÍSTICAS: 12V 3.0 BAR 100L/H

REPLACES / REEMPLAZA:

AIRTEX: E8254, **BOSCH**: 0 986 580 013; **FORD**: 1033375, F2AZ9A407A, F7UZ9H307BC, F7UZ9H307CC, F7UZ9H307DB; **GM**: 251 64 855, 300 10245, 30013078, 30014333, 30018727, 30019572, 91171624, 91173412, 943 84 528, 94856915; **HONDA**: 17040S04L00, 17040S10A01, 17040S10A00, 17040S84A01, 17040SR1A30, 17040SR2A32, 17040SR2A50, 17040SS8A02, 17040SS8A00, 17040ST7L00, 17040SV1A30, 17040SV1A31, 17040SV1L01, 17040SV1L00, 17040SV4 A30, 17040SW5A30, 17040SW5A31, 17040SW5A32, 17040SXOA32, 17040SY8A01; **HYUNDAI**: 31111-28100, 31111-28300, 31111-22050, 31111-23300, 31111-28150, 31111-28300, 31111-29000, 31111-37100, 31111-37150, 31111-37200, 31111-37250, 31111-37300, 31111 38000; **ISUZU**: 5-86202-235-0, 8-94384-528-0, 8-94384-528-1, 8944794181, 8944794182, 8-97041-876-1, 8-97041-876-3, 8971185120, 8971188580; **JAGUAR**: JLM12159, JLM20756; **JEEP**: 4897755AB;

KIA: OK01A13K01, OK01D1335Z, K24C1335ZA, OK29T13355Z, OK2AC1335Z, 4897755AB, OK01A13350B; **LADA**: 6443649; **MAZDA**: JE451335ZB, JE471335ZA, JE4813350C, JE481335ZC; **MITSUBISHI**: MB-698857, MB-831262, MB-831333, MB-927016, MB-959729, MB-959730, MB-959847, MR-124765 MR-124881, MR-124999, MR-134284, MR-134804, MR-134868, MR-135289, MR-208665, MR-241080, MR-241083, MR-241351, MR-241394, MR-325884, MR-831562, MR-912304; **NISSAN**: 17040-3S505, 17042-31U00, 17042-8B000; **SUBARU**: 742021360, 742021390, 42021-AA330, 42021-AA350, 42021-AC001, 42021-AC012, 42021-FA200, 42021-FA250, 42021-FC021; **SUZUKI**: 15100-50G00, 15100-57B10, 15100-58B10, 15100-58B00, 1510060G20, 1510060G00, 1510061A02, 1510061AA1, 1510065D00, 1510077E00, 1511050GTO, 1511060GTO; **TOYOTA**: 23220-03020, 23220-03030, 23220-03040, 23220-20020, 23220-74020, 23220-74021, 23221-03010, 23221-11050, 23221-16490, 23221-46010, 23221-46060, 23221-46070, 23221-46120, 23221-74110, 23221-76030, 23220-0C010, 23221-0D010

APPLICATION / APLICACIÓN:

CHRYSLER: SEBRING DESCAPOTABLE(JR) 2.4 04/01-12/04;

HONDA: INSIGHT(ZE) 1.0 04/00->;

MITSUBISHI: GALANT VI(EA_) 2.4L 02/99-09/00, GALANT VI RANCHERA FAMILIAR(EA_) 2.4GDL 02/99-09/00, ECLIPSE 2.4 05/99-12/02, GALANT SEDAN 2.4GDL SPORT 10/03-12/04, ECLIPSE DESCAPOTABLE 2.4RS 05/99->, LANCER SEDAN 2.0L/2.4L 09/03->;

LEXUS: 3.0L 05/93-12/05



GI3805E // NEW //

FEATURES / CARACTERÍSTICAS:

REPLACES / REEMPLAZA:

TOYOTA: 23220-74020, 23220-74021, 23220-03040, 23221-11050

APPLICATION / APLICACIÓN:

TOYOTA: COROLLA Liftback (E10) (1994/01 - 2000/09), COROLLA Wagon (E10)(1992/05 - 1997/04), CAMRY Saloon (CV1, XV1, V1)(1991/06 - 1997/09)



GI3806

FEATURES / CARACTERÍSTICAS: 12V 3.0 BAR 85L/H

REPLACES / REEMPLAZA:

AIRTEX: E8240; **LEXUS**: 3221-46060, 23221-46120, 23221-50060, 23221-62010, 23221-74110; **TOYOTA**: 23221-50060, 23221-00000

APPLICATION / APLICACIÓN:

AIRTEX: GS (JZS147) 300 3.0 03/93-08/97; **LEXUS**: Lexus (6V) 3.0 92-98; **TOYOTA**: CROWN 3.0 91-93/ 04/93> 12/05



GI3807

FEATURES / CARACTERÍSTICAS: 12V 3.0BAR 100L/H 5.5A

REPLACES / REEMPLAZA:

AIRTEX: E2157, E2254; **BOSCH**: F000TE1713; **CHEVROLET**: 25116525*; **LEXUS**: 23220-03020, 23221-11050, 23221-0D010; **TOYOTA**: 23220-74020, 23220-74021, 23221-03010; **WALBRO**: 5CA231; **FORD**: F7AZ-9350AA, F7AZ-9350AB

APPLICATION / APLICACIÓN:

MAZDA: 2.0L 02/98-12/02;

MERCURY: 06/93-12/98;

FORD: Fiesta, Ka 1.0 /1.3 /1.6 (Motor Endura /MPI - Motor Zetec) 96>, Escort, Ranger 02>, Explorer V6 /V8 02>, F150, F250, F350 V6 /V8 02>, TRUCK 4.6L 06/95-12/03;

NISSAN: Quest 02>





GI3807B

FEATURES / CARACTERÍSTICAS: 12V 3.0 BAR 85L/H

REPLACES / REEMPLAZA:

AIRTEX: E2226; FORD: 3M5U-9350-AA; CARTER: P14000

APPLICATION / APLICACIÓN:

FORD: LOBO F150, F250, F350, EXPEDITION, EXPLORER, NAVIGATOR, RANGER;

MERCURY: 02/97--12/02;

MAZDA: 04/98--12/01, LINCOLN: 03/97--12/02



GI3807C

FEATURES / CARACTERÍSTICAS: 12V 3.0 BAR 85L/H

REPLACES / REEMPLAZA:

KEM: 269E; FORD: SGUU-9350-B1A, VPILZV-9350-JÁ, XL2V-9350-AA; MAZDA: KLG4-13-350A

APPLICATION / APLICACIÓN:

FORD: ESCORT VIII 1.3L/1.4L/1.6L 97->, FIESTA 1-1.3L 93->, FIESTA 1-1.4L 95->, MONDEO 1.6L/1.8L/2.0L,



GI3807D

FEATURES / CARACTERÍSTICAS: 12V 3.0BAR 100L/H 5.5A

REPLACES / REEMPLAZA:

AC DELCO: MU2019; DELPHI: FE0319

APPLICATION / APLICACIÓN:

MAZDA: 2.0L 02/98--12/02;

FORD



GI3807E

FEATURES / CARACTERÍSTICAS: 12V 3.0 BAR 85 L/H

REPLACES / REEMPLAZA:

DELPHI: FE0321

APPLICATION / APLICACIÓN:

FORD TRUCK: 02/99--12/00;

MERCURY: TRUCK



GI3807F

FEATURES / CARACTERÍSTICAS: 12V 3.0 BAR 85 L/H

REPLACES / REEMPLAZA:

AIRTEX: E2226

APPLICATION / APLICACIÓN:

MAZDA: 04/98--12/01;

MERCURY: 04/97--12/02;

LINCOLN: 06/97--12/02;

FORD: 06/97--12/04



GI3807KT // NEW //

FEATURES / CARACTERÍSTICAS: GI3807 with kit GK3009

REPLACES / REEMPLAZA:

FORD: F7AZ-9350AA, F7AZ-9350AB, XW1U9H307AC, XW1U9H307AE, F8AZ9H307AC, F8AU9H307AC, F7AU9A407AB, 1W1Z9H307AB, 1W1Z 9H307-BD, 1W1Z 9H307-BC, 1W1U9H307BD, XW1Z 9H307-AB, F7AU9H307AB; DELPHI: FE0296

APPLICATION / APLICACIÓN:

FORD: F-150 1999>2002, Truck 4.6L 1995>2003, Fiesta 1.0 (Motor Endura /MPI - Motor Zetec) 1996>, Fiesta 1.3 (Motor Endura /MPI - Motor Zetec) 1996>, Fiesta 1.6 (Motor Endura /MPI - Motor Zetec) 1996>, Ka 1.0 (Motor Endura /MPI - Motor Zetec) 1996>, Ka 1.3 (Motor Endura /MPI - Motor Zetec) 1996>, Ka 1.6 (Motor Endura /MPI - Motor Zetec) 1996>, Escort 2002>, Ranger 2002>, Explorer V6 /V8 2002>, F150 2002>, F250 2002>, F350 V6 /V8 2002> NISSAN: Quest F27 2002>



GI3808

FEATURES / CARACTERÍSTICAS: 12V 3.0 BAR 100L/H

REPLACES / REEMPLAZA:

AC DELCO: EP1005, EP457, EP458, EP459; AIRTEX: E8213; BMW: 16141185842; PIERBURG: 7.00240.00.0, 7.21088.02.0, 7.21088.62.0;

TOYOTA: 23220-03020, 23220-03040, 23220-74020

APPLICATION / APLICACIÓN:

TOYOTA: RAV 4(SXA1_) 2.0 16V 06/94-06/00 COROLLA COMPACT(E10_) 1.6/1.8L 07/92-04/97 COROLLA LIFTBACK(E10_) 1.6/1.8L 07/92-04/97 COROLLA WAGON(E10_) 1.6/1.8L 07/92-04/97 4 RUNNER(_N130) 2.4/2.7/3.0/3.4L 01/92-11/95 CAMRY(_V1_) 2.2/3.0L 06/91-08/96 CAMRY STATION WAGON(_V10) 2.2/3.0L 03/92-07/96 CARINA E SEDAN(_T19_) 1.6/1.8/2.0L 01/96-09/97 CARINA E(_T19_) 1.6/1.8/2.0L 01/96-09/97*, CARINA E SPORTSWAGON(_T19_) 1.6/1.8/2.0L 01/96-09/97, CELICA(_T20_) 1.6/1.8L(AT200/ST) 11/93-11/99, PASEO(EL54) 1.5 16V 08/95-07/99, AVENSIS(_T22_) 1.6/1.8/2.0L 10/97-07/00, AVENSIS STATION WAGON(T22_) 1.6/1.8/2.0L 10/97-07/00, CAMRY(_V20) 2.2L/3.0L 08/96-11/01, COROLLA(_E10_) 1.6SL(AE101_) 09/95-04/97, AVENSIS LIFTBACK(_T22_) 1.6/1.8/2.0L 10/97-07/00, RAV 4 I CABRIO(SXA1_) 2.05 16V 12/97-06/00, PASEO DESCAPOTABLE(EL54) 1.5 16V 10/96-03/99, CELICA(ZZT23_) 1.8L 11/99->, CAMRY (_V30) 3.0 V6 11/01->;

LEXUS: ES(F1, F2) 300 09/91-12/97;

CHEVROLET : 02/98--12/01;

PONTIAC: 06/98--12/99

GI3808KT

FEATURES / CARACTERÍSTICAS:

REPLACES / REEMPLAZA:

AC DELCO: EP1005, EP457, EP458, EP459; **AIRTEX:** E8213; **BMW:** 16141185842; **PIERBURG:** 7.00240.00.0, 7.21088.02.0, 7.21088.62.0; **TOYOTA:** 23220-03020, 23220-03040, 23220-74020

APPLICATION / APLICACIÓN:

TOYOTA: RAV 4(SXA1_) 2.0 16V 06/94-06/00 COROLLA COMPACT(E10_) 1.6/1.8L 07/92-04/97 COROLLA LIFTBACK(E10_) 1.6/1.8L 07/92-04/97 COROLLA WAGON(E10_) 1.6/1.8L 07/92-04/97 4 RUNNER(_N130) 2.4/2.7/3.0/3.4L 01/92-11/95 CAMRY(_V1_) 2.2/3.0L 06/91-08/96 CAMRY STATION WAGON(_V10) 2.2/3.0L 03/92-07/96 CARINA E SEDAN(_T19_) 1.6/1.8/2.0L 01/96-09/97 CARINA E(_T19_) 1.6/1.8/2.0L 01/96-09/97, CARINA E SPORTSWAGON(_T19_) 1.6/1.8/2.0L 01/96-09/97, CELICA(_T20_) 1.6/1.8L(AT200/ST) 11/93-11/99, PASEO(EL54) 1.5 16V 08/95-07/99, AVENSIS(_T22_) 1.6/1.8/2.0L 10/97-07/00, AVENSIS STATION WAGON(T22_) 1.6/1.8/2.0L 10/97-07/00, CAMRY(_V20) 2.2L/3.0L 08/96-11/01, COROLLA(_E10_) 1.6SL(AE101_) 09/95-04/97, AVENSIS LIFTBACK(_T22_) 1.6/1.8/2.0L 10/97-07/00, RAV 4 I CABRIO(SXA1_) 2.05 16V 12/97-06/00, PASEO DESCAPOTABLE(EL54) 1.5 16V 10/96-03/99, CELICA(ZZT23_) 1.8L 11/99->, CAMRY(_V30) 3.0 V6 11/01->;

LEXUS: ES(F1, F2) 300 09/91-12/97;

CHEVROLET : 02/98--12/01;

PONTIAC: 06/98--12/99



GI3809

FEATURES / CARACTERÍSTICAS: 12V 3.0 BAR 100L/H

REPLACES / REEMPLAZA:

BOSCH: 0-580-453-483; **WALBRO:** GCA3350, GSS3348; **KIA:** AOK008, AOK099; **DAEWOO:** AOD009

APPLICATION / APLICACIÓN:

CHEVROLET: C&K SERIES PICKUP 4.3L, LUMINA 3.1L, S10 BLAZER 4.3L, SUBURABN 5.7L/7.4L;

GM: S&K SERIES PICKUP 4.3L, JIMMY 4.3L, SAFARI 4.3L, SUBURABN 7.4L YOKUN 5.7L;

DAEWOO: LANOS 1.4L/1.6L, CIELO 1.4L/1.6L;

KIA: CLARVS(KSA) 1.8L/2.0L;

HYUNDAI: 1.5L 10/89--01/95



GI3810

FEATURES / CARACTERÍSTICAS: 12V 3.0BAR 100L/H 5.5A

REPLACES / REEMPLAZA:

BOSCH: 0 580 453 465, 0 580 454 140, 986580699; **DAEWOO:** MAPCO: 22711; **PIERBURG:** 7.00468.60.0; **VDO:** 993-784-025X; **MD:** 76539; **ERA:** 770042; **NISSAN:** 170421W700; **OPEL:** 815037, 815039, 9120218, 9200109, 9204647, 815037, 815039, 9120218, 91202180, 9128644, 9200109, 92001090, 9204647; **S.I.D.A.T. S.r.l.:** 70027; **VALEO SERVICE DEUTSCHLAND GMBH:** 347255; **VAUXHALL:** 815037, 815039, 9120218, 9200109

APPLICATION / APLICACIÓN:

DAEWOO: ESPERO, LANOS, LEGANZA, MATIZ, NUBIRA, REZZO;

VW: SANTANA 99;

OPEL: ASTRA G BOX(F70) 1.6L, ASTRA G CONVERTIBLE 1.6L/1.8L 01/03-03-01, ASTRA G COUPE(F07) 1.6/1.8/2.0L 03/00-10/00, ASTRA G ESTATE(F35) 1.2/1.4/1.6/1.8/2.0L 02/98-09/00, ASTRA GHATCHBACK(F48/F08) 1.2/1.4/1.6/1.8/2.0L, ASTRA GSALON(F69) 1.2/1.4/1.6/1.8/2.0L 02/98-10/02, COMBO (71) 1.4L 09/98-12/02, COMBO BOX BODY/ESTATE 1.6L 07/94-10/01, COMBO TOUR 1.6 10/01->, CORSA 1.0/1.2/1.4/1.6L 10/01->, OMEGA B(25/26/27) 2.0/2.2/2.5/3.0L 03/93-09/00, OMEGA B ESTATE(21/22/23) 2.0/2.2/2.5/3.0L 03/94-07/03, TIGRA (95) 1.4L/1.6L 07/94-12/00, VECTRA B(36) 1.6/1.8/2.0/2.2/2.5/2.6L 10/95-04/02, VECTRA B ESTATE (31)1.6/1.8/2.0/2.2/2.5/2.6L 11/96-02/02, VECTRA B HATCHBACK(38) 1.6/1.8/2.0/2.2/2.5/2.6L 10/95-02/02, ZAFIRA (F75) 1.6/1.8L 04/99-09/00;

DAEWOO: LEGANZA 2.0L, ESPERO 1.8/2.0L, LANOS 1.4/1.6L 97, LEGANZA 2.0/2.2L 97, MATIZ 0.8L 98



GI3812

FEATURES / CARACTERÍSTICAS: 12V 3.0 BAR 100L/H

REPLACES / REEMPLAZA:

NISSAN: 17042-31U08, 17042-4P066; **PEUGEOT:** 145506, 145511, 96097244, 990005600

APPLICATION / APLICACIÓN:

NISSAN: MAXIMA QX(A32) 2.0/3.0L 02/95-08/00



GI3818A

FEATURES / CARACTERÍSTICAS: 12V 4.2 BAR 100L/H

REPLACES / REEMPLAZA:

BOSCH: 0580454008

APPLICATION / APLICACIÓN:

BUICK;

CHEVROLET;

VW;

FORD



GI3819

FEATURES / CARACTERÍSTICAS: 12V 3.0 BAR 100L/H

REPLACES / REEMPLAZA:

WALBRO: GCA3348

APPLICATION / APLICACIÓN:

CHEVROLET: C&K SERIES PICKUP 4.3L/5.7L 96-97, LUMINA 3.1L 98, S10 BLAZER 4.3L 95-98, SUBURABN 5.7L/7.4L 97, JIMMY 4.3L 96, SAFARI 4.3L 96, YUKON 5.7L 96;

GM: C&K SERIES PICKUP 4.3L 96-97, JIMMY 4.3L 96, SAFARI 4.3L 96, SUBURBAN 7.4L 96-97, YUKON 5.7L 96, DAEWOO: LANOS, CIELO 1.4L/1.6L;

GMC: 02/96--12/97





G13820

FEATURES / CARACTERÍSTICAS: 12V 3.0 BAR 100L/H

REPLACES / REEMPLAZA:

KEM: 6200-E; GM: 25363861, 25186924

APPLICATION / APLICACIÓN:

BUICK: CENTURY 189CID 3.1L 99-98, REGAL 231CID 3.8L 99-98;

OLDSMOBILE: INTRIGUE 214CID 3.5L 00-99, INTRIGUE 231CID 3.8L 99-98;

PONTIAC: GRAND PRIX 189CID 3.1L 00-98, GRAND PRIX 231CID 3.8L 00-98



G13822

FEATURES / CARACTERÍSTICAS: 12V 3.0 BAR 100L/H

REPLACES / REEMPLAZA:

BOSCH: 0-580-454-032, 0-580-314-067; VOLVO: 3501615, 3501619, 9135418, 9135605, 3501615; DAEWOO: 96291866

APPLICATION / APLICACIÓN:

VOLVO: S40 1.9L 05/97-07/00, 850(LS) 2.0L



G13822D

FEATURES / CARACTERÍSTICAS: 12V 3.0 BAR 95L/H

REPLACES / REEMPLAZA:

-

APPLICATION / APLICACIÓN:

LADA



G13824

FEATURES / CARACTERÍSTICAS: 12V 3.0 BAR 100L/H

REPLACES / REEMPLAZA:

-

APPLICATION / APLICACIÓN:

FIAT: Panda



G13826

FEATURES / CARACTERÍSTICAS: 12V 2.0BAR 60L/H 5.0A

REPLACES / REEMPLAZA:

DENSO: 23222-OP010, 291000-0310, 23220-0C050, 23220-75040; MD: 77312

APPLICATION / APLICACIÓN:

TOYOTA: CAMRY, YARIS



G13826A

FEATURES / CARACTERÍSTICAS: 12V 2.0 BAR 110L/H

REPLACES / REEMPLAZA:

DENSO: 23222-21132

APPLICATION / APLICACIÓN:

SUZUKI: SWIFT



G13826B

FEATURES / CARACTERÍSTICAS: 12V 3.0 BAR 100L/H

REPLACES / REEMPLAZA:

KIA: 31111-1R-000

APPLICATION / APLICACIÓN:

KIA: Picanto 1.0 Bi-Fuel 2011>, Rio III 1.2 CVVT 2014>, Rio III 1.25 CVVT 2011>, Rio III 1.25 LPG 2011>, Rio III 1.4 CVVT 2011>, Rio III Saloon 1.25 CVVT / 1.4 CVVT 2011>, Sorento II 2.4 CVVT / 2.4 CVVT 4WD 2009>, Sportage 2.0 CVVT / 2.0 CVVT AWD 2010>;

HYUNDAI: Accent 2006>2010, Elantra 2006>2010, Sonata 2.4 2006>2010



GI3826BKT

FEATURES / CARACTERÍSTICAS: 12V 3.0 BAR 100L/H. GI3826B with kit, just gasoline

REPLACES / REEMPLAZA:

KIA: 31111-1R-000

APPLICATION / APLICACIÓN:

KIA: Picanto 1.0 Bi-Fuel 2011>, Rio III 1.2 CVVT 2014>, Rio III 1.25 CVVT 2011>, Rio III 1.25 LPG 2011>, Rio III 1.4 CVVT 2011>, Rio III Saloon 1.25 CVVT / 1.4 CVVT 2011>, Sorento II 2.4 CVVT / 2.4 CVVT 4WD 2009>, Sportage 2.0 CVVT / 2.0 CVVT AWD 2010>;

HYUNDAI: Accent 2006>2010, Elantra 2006>2010, Sonata 2.4 2006>2010



GI3826AKT

FEATURES / CARACTERÍSTICAS:

REPLACES / REEMPLAZA:

Denso: 23222-21132

APPLICATION / APLICACIÓN:

SUZUKI: Swift



GI3826KT

FEATURES / CARACTERÍSTICAS:

REPLACES / REEMPLAZA:

Denso: 23222-OP010, 291000-0310; **MD:** 77312

APPLICATION / APLICACIÓN:

GI3826 with kit GF175 + connector

TOYOTA: Camry, Yaris



GI3826C

FEATURES / CARACTERÍSTICAS: 12V 2.0BAR 90L/H 5.2A

REPLACES / REEMPLAZA:

DENSO: 23220-0P130

APPLICATION / APLICACIÓN:

-



GI3830

FEATURES / CARACTERÍSTICAS: 12V 3.0 BAR 100L/H

REPLACES / REEMPLAZA:

VOLVO: 3061161, GRJ235; **WALBRO:** ERT235, GRJ235

APPLICATION / APLICACIÓN:

VOLVO: S40 I(VS) 1.8/1.9/2.0L 95-00, V40 ESTATE(VW) 1.8/1.9/2.0L 95-00



GI3835

FEATURES / CARACTERÍSTICAS: 12V 3.0 BAR 100L/H

REPLACES / REEMPLAZA:

AIRTEX: E2446

APPLICATION / APLICACIÓN:

FORD: ESCORT;

MERCURY: TRACER



GI3837

FEATURES / CARACTERÍSTICAS: 12V 3.0 BAR 100L/H

REPLACES / REEMPLAZA:

TOYOTA: 23221-62060

APPLICATION / APLICACIÓN:

-



GI3840

FEATURES / CARACTERÍSTICAS: 13.5V 3.5 BAR 100L/H

REPLACES / REEMPLAZA:
EP204TA

APPLICATION / APLICACIÓN:

FORD: Ford PRZ



GI3841

FEATURES / CARACTERÍSTICAS: 12V 3.0 BAR 140L/H

REPLACES / REEMPLAZA:
AIREX: E2446, E2447

APPLICATION / APLICACIÓN:

-



GI3841A

FEATURES / CARACTERÍSTICAS: 12V 3.0 BAR 140L/H

REPLACES / REEMPLAZA:
AIREX: E2318, E2390

APPLICATION / APLICACIÓN:

-



GI3901

FEATURES / CARACTERÍSTICAS: 13.5V 3.0BAR 255L/H

REPLACES / REEMPLAZA:

AC DELCO: EP460, EP463, EP482; **WALBRO**: GCA308, GCA309, GCA310, GCA312, GCA313, GSS342

APPLICATION / APLICACIÓN:

FORD: LINCOLN;

MAZDA: 02/93--12/97;

JEEP: 02/94



GI3902

FEATURES / CARACTERÍSTICAS: 13.5V 3.0BAR 255L/H

REPLACES / REEMPLAZA:

AC DELCO: EP318, EP458, EP459, EP475, EP479, EP485, EP557, EP558, EP560, EP562, EP564, PEP1778; KEM: EFP3304, EFP8240; **WALBRO**: FE0038, FE0048, GCA3357, GCA3361, GCA3362; JEEP: 4762964, 4798941, 4874172, 4874173, 4897755, 52018387, 52018390, 52018391, 05010019AA, 4874173AB, 4886518AA, 4897754AB; **FORD**: 1W1Z-9H307BC

APPLICATION / APLICACIÓN:

FORD;

MAZDA;

CADILLAC: 12/86;

BUICK: 04/87--12/92;

CHEVROLET: 06/87--12/90;

OLDSMOBILE: 06/87--12/91;

PONTIAC: 04/88--12/89



GI3903

FEATURES / CARACTERÍSTICAS: 13.5V 3.0BAR 255L/H

REPLACES / REEMPLAZA:

WALBRO: GCA3350

APPLICATION / APLICACIÓN:

VOLVO: 87-90



GI3904

FEATURES / CARACTERÍSTICAS: 12V 3.5 BAR 100L/H

REPLACES / REEMPLAZA:

AC DELCO: EP7123; **AIRTEX**: E7049; **WALBRO**: GRJ429

APPLICATION / APLICACIÓN:

DODGE: RAM 1500 PICKUP 239CID 3.9L 95->, RAM 1500 PICKUP 318CID 5.2L 95->, PAM 1500 PICKUP 360CID 5.9L 95->, PAM 1500 PICKUP 488CID 8.0L 95-94

GI3981

FEATURES / CARACTERÍSTICAS:

REPLACES / REEMPLAZA:

BOSCH: 0 580 464 981; FIAT: 46447569, 46742145; MEAT & DORIA: 76808

APPLICATION / APLICACIÓN:

FIAT: Ducato Minibus 2.0/2.8 2000>2002, Ducato Van 2.8 2000>2002, Ducato Flatbed 2.8 2000>2002



GI4301

FEATURES / CARACTERÍSTICAS: 12V 3.0BAR 105L/H 6.3A

REPLACES / REEMPLAZA:

AIRTEX: E10355; **VDO:** E22041 047-993 763011Z; **VW:** 1H0906091, 1H0906091D, 3A5919051L, BAC919651, 1H0 919 051 AJ, 1H0 919 051 AK, 1H0 919 051 K, 1H0 919 651 Q; **AUDI:** 1H0906091, 1H0919051AK, 1H0919051L, 1H0919651Q; **ERA:** 770043; **FEBI BILSTEIN:** 14350, 24870; **FORD:** 1028808, 1 028 808, 1047280, 1H0906091, 95VW 9H307 AC, 95VW 9H307-AC, 96VW 9H307-AA; **HOFFER:** 7506399; **JOHNS:** KSP 95 38-005; **KAGER:** 52-0033; **MEAT & DORIA:** 76399; **METZGER:** 2250010; **MEYLE:** 100 919 0044; **MS MOTOR SERVICE DEUTSCHLAND GMBH:** 702550580; **PIEBURG:** 7.02550.58.0; **PTZ:** PTZ-5507; **SEAT:** 1H0906091; **SIDAT:** 70029; **SWAG:** 30 91 4350, 30 92 4870; **VEMO:** V10-09-0806; **VOLKSWAGEN:** 1H0906091; **MD:** 76399

APPLICATION / APLICACIÓN:

FORD: GALAXY (WGR) 2.0/2.3/2.8L 11/95-05/98;

SEAT: CORDOBA (6K2/C2) 1.4/1.6/1.8/2.0L 06/94-06/99, IBIZA II (6K1) 1.4L 16V 09/06-08/99, INCA (6K9) 1.4L 11/95->, ALHAMBRA (7V8, 7V9) 2.0/1.8L 04/96-05/98, CORDOBA VARIO (6K5) 1.4L 09/96-06/99, CORDOBA VARIO (6K5) 1.6L 09/96-06/99, ALHAMBRA (7V8, 7V9) 2.0 1.85Kw 115CV 1984cc, CORDOBA (6K1, 6K2) 1.0 1.37Kw 50CV 999cc/ 1.4 1.44Kw 60CV 1390cc/ 1.4 1.16V 74Kw 101CV 1390cc/ 1.6 1.55Kw 75CV 1598cc/ 1.6 1.74Kw 101CV 1595cc/ 1.8 1.16V 95Kw 129CV 1781cc/ 2.0 1.85Kw 115CV 1984cc/ 2.0 1.16V 110Kw 150CV 1984cc, CORDOBA (6K2) 1.0 37Kw 50CV 999cc/ 1.0 1.6V 51Kw 69CV 999cc/ 1.4 44Kw 60CV 1390cc/ 1.4 1.6V 55Kw 75CV 1390cc/ 1.4 1.6V 74Kw 100CV 1390cc/ 1.6 55Kw 75CV 1598cc/ 1.6 74Kw 101CV 1595cc, CORDOBA Vario (6K5) 1.4 44Kw 60CV 1390cc/ 1.4 1.6V 55Kw 75CV 1390cc/ 1.4 1.44Kw 60CV 1390cc/ 1.6 55Kw 75CV 1598cc/ 1.6 74Kw 101CV 1595cc/ 1.6 1.74Kw 101CV 1595cc/ 1.6 1.74Kw 101CV 1595cc/ 1.8 1.16V 95Kw 129CV 1781cc/ 2.0 1.85Kw 115CV 1984cc/ 2.0 1.16V 110Kw 150CV 1984cc/ IBIZA III (6K1) 1.0 37Kw 50CV 999cc/ 1.0 1.6V 51Kw 69CV 999cc/ 1.4 44Kw 60CV 1390cc/ 1.4 1.6V 55Kw 75CV 1390cc/ 1.4 1.6V 74Kw 100CV 1390cc/ 1.6 74Kw 101CV 1595cc/ 1.6 55Kw 75CV 1598cc/ INCA (6K9) 1.4 1.6V 55Kw 75CV 1390cc/ 1.4 1.44Kw 60CV 1390cc/ 1.6 1.55Kw 75CV 1598cc/ TOLEDO I (1L) 1.6 1.74Kw 101CV 1595cc/ 2.0 1.85Kw 115CV 1984cc/ 2.0 1.16V 110Kw 150CV 1984cc;

VOLKSWAGEN: PASSAT (3A2, 35I) 1.6L/2.0L 10/93-08/96, PASSAT VARIANT (3A5, 35I) 1.6L/2.0L 10/93-05/97, POLO (6N1) 75 1.6 10/94-10/99, TRANSPORTER IV AUTOBUS (70XB, 70XC, 7DB, 7DW) 2.5L SYNCRO/2.0L 11/92-04/03, GOLF III CABRIOLET (1E7) 1.6/2.0L 07/93-05/98, GOLF III (1H) 1.4/1.6/2.0/2.8L 09/92-08/97, GOLF III VARIANT (1H5) 1.4/1.6/2.0L 07/93-04/99, SHARA (7M8, 7M9, 7M6) 1.8/2.0/2.8L 09/95-05/98, POLO CLASSIC (6KV2) 60 1.4L 12/95-09/01, POLO CLASSIC (6KV2) 100 1.6 12/95-09/01, TRANSPORTER IV FURGON (70XA) 2.0/2.5L 10/92-04/03, TRANSPORTER IV CAJA/CHASIS (70XD) 2.0/2.5L 10/92-04/03, GOLF IV CABRIOLET (1E7) 1.6/2.0L 06/98-06/02, VENTO (1H2) 1.4/1.6/2.0/2.8L 11/91-09/98, CORRADO (53I) 2.0L 16V 10/94-12/95, CADDY II Kasten (9K9A) 1.4 55Kw 75CV 1390cc/ 60 1.4 44Kw 60CV 1390cc/ 75 1.6 55Kw 75CV 1598cc, CADDY II Kombi (9K9B) 1.4 44Kw 60CV 1390cc/ 1.4 1.6V 55Kw 75CV 1390cc/ 1.6 55Kw 75CV 1598cc, CADDY II Pick-up (9U7) 1.6 55Kw 75CV 1598cc, CORRADO (53I) 2.0 1.85Kw 115CV 1984cc, GOLF III (1H1) 1.4 40Kw 55CV 1390cc/ 1.4 44Kw 60CV 1390cc/ 1.6 55Kw 75CV 1598cc/ 1.6 74Kw 101CV 1595cc/ 2.0 85Kw 115CV 1984cc/ 2.0 Syncro (1HX1) 85Kw 115CV 1984cc, GOLF III Cabriolet (1E7) 1.6 74Kw 101CV 1595cc/ 2.0 85Kw 115CV 1984cc, GOLF III Variant (1H5) 1.4 44Kw 60CV 1390cc/ 1.6 74Kw 101CV 1595cc/ 2.0 85Kw 115CV 1984cc/ 2.0 Syncro 85Kw 115CV 1984cc, PASSAT (3A2, 35I) 1.6 74Kw 101CV 1595cc/ 2.0 85Kw 115CV 1984cc, PASSAT Variant (3A5, 35I) 1.6 74Kw 101CV 1595cc/ 2.0 85Kw 115CV 1984cc/ 2.0 Syncro 85Kw 115CV 1984cc, POLO (6N1) 100 1.4 1.6V 74Kw 100CV 1390cc/ 120 1.6 16V GTI 88Kw 120CV 1598cc/ 50 1.0 37Kw 50CV 999cc/ 55 1.4 40Kw 55CV 1390cc/ 60 1.4 44Kw 60CV 1390cc/ 75 1.6 55Kw 75CV 1598cc, POLO (6N2) 1.0 37Kw 50CV 999cc/ 1.4 44Kw 60CV 1390cc/ 1.4 40Kw 54CV 1390cc/ 1.4 1.6V 55Kw 75CV 1390cc/ 1.4 1.6V 74Kw 101CV 1390cc/ 1.6 16V GTI 92Kw 125CV 1598cc, POLO CLASSIC (6KV2) 100 1.6 74Kw 100CV 1595cc/ 2.0 85Kw 116CV 1984cc/ 60 1.4 44Kw 60CV 1390cc, 1.4 40Kw 54CV 1390cc, 1.4 1.6V 55Kw 75CV 1390cc, 1.6 55Kw 75CV 1598cc, 1.6 74Kw 101CV 1595cc/ SHARAN (7M8, 7M9, 7M6) 1.8 T 20V 110Kw 150CV 1781cc, 2.0 85Kw 115CV 1984cc/ TRANSPORTER IV Bus (70XB, 70XC, 7DB, 7DW) 2.0 62Kw 84CV 1968cc, 2.5 81Kw 110CV 2461cc, 2.5 85Kw 115CV 2461cc, 2.5 Syncro 81Kw 110CV 2461cc, 2.5 Syncro 85Kw 115CV 2461cc, 2.8 VR 6 103Kw 140CV 2792cc/ TRANSPORTER IV Kasten (70XA) 2.0 62Kw 84CV 1968cc, 2.5 81Kw 110CV 2461cc, 2.5 85Kw 115CV 2461cc, 2.5 Syncro 81Kw 110CV 2461cc, 2.5 Syncro 85Kw 115CV 2461cc/ TRANSPORTER IV Pritsche/Fahrgestell (70XD) 2.0 62Kw 84CV 1968cc, 2.5 81Kw 110CV 2461cc, 2.5 85Kw 115CV 2461cc, 2.5 Syncro 81Kw 110CV 2461cc, 2.5 Syncro 85Kw 115CV 2461cc, VENTO (1H2) 1.4 40Kw 55CV 1390cc, 1.4 44Kw 60CV 1390cc, 1.6 55Kw 75CV 1598cc, 1.6 74Kw 101CV 1595cc, 2.0 85Kw 115CV 1984cc.

GI4301A

FEATURES / CARACTERÍSTICAS: 12V 1.2 BAR 100 L/H

REPLACES / REEMPLAZA:

BOSCH: 0580453514, 0580450000

APPLICATION / APLICACIÓN:

Vehicles VW





GI4302

FEATURES / CARACTERÍSTICAS: 12V 3.8BAR 110L/H 8.0A

REPLACES / REEMPLAZA:

VDO: E22-041-027Z, 993784031; **MAPCO:** 22870; **VW:** 8E0-906-087C, 1GD0919051B; **MD:** 76809; **AUDI:** 3B0919051B, 6N0919051N; MS Motor Service Deutschland GmbH: 7.02550.61.0; **ROBERT BOSCH GMBH:** 0 986 580 805; S.I.D.A.T. S.r.l.: 70485; **VOLKSWAGEN:** 6N0919051N; **AUDI:** 1GD919051B*, 1J0 919 051 B, 1J0 919 051 C, 1J0919051C*, 1J0919051E*, 1J0919051H*, 1J0 919 087, 1J0 919 087 C, 1J0919087C*, 1J0 919 087 D, 1J0919087D*, 1J0919087H*, 3B0919051B, 3B0919051C*, 6N0919051M*, 6N0919087F*, 6Q0919051*, 6X0919051C*, 6X0919051E*, 6X0919051G*, 6X0919056E*, 6X0919056G*, 6X0919087B*, 6X0919087D*, 7M0919051H*, 7M0919051J*, 7M0919087D*, 7M3919051*, 7M3919051A*, 8L0919087A*, 8L0919087E*, 8Z0919051*, 8Z0919051A*, 8Z0919051C*; **BOSCH:** 986580824; **FEBI BILSTEIN:** 27008; **HOFFER:** 7506809; **KAGER:** 52-0035; **MAPCO:** 22870; **MEAT & DORIA:** 76809; **METZGER:** 2250096; **MEYLE:** 100 919 0057; **MS MOTOR SERVICE DEUTSCHLAND GMBH:** 702550610; **PIERBURG:** 7.02550.61.0; **ROBERT BOSCH GMBH:** 0986580805; **SIDAT:** 70485; **SWAG:** 30 92 7008; **VAG:** 1GD 919 051 B, 1J0919051B*, 1J0 919 051 H, 1J0 919 051 K, 1J0 919 087 H, 1J0 919 087 J, 1J0919087J*, 3B0 919 051 B, 3B0919051B*, 3B0 919 051 C, 4B0 919 051 E, 6K0919051C*, 6N0 919 087 F, 6Q0 919 051, 6Q0 919 051 F, 6U0 919 051 D, 6U0 919 051 F, 6UD 919 051 E, 7H0 919 087, 7M0 919 087 B, 7M0 919 087 D; **VEMO:** V10-09-1242;

APPLICATION / APLICACIÓN:

BEETLE: 00-04;

SHARAN: 1.8L, VR6 00-04;

DERBY: 02-04;

IBIZA: 02-04;

AUDI: A2 (8Z0) 1.4 55Kw 75CV 1390cc, 1.6 FSI 81Kw 110CV 1598cc/A3 (8L1) 1.6 74Kw 101CV 1595cc, 1.6 75Kw 102CV 1595cc, 1.8 92Kw 125CV 1781cc, 1.8 T 110Kw 150CV 1781cc, 1.8 T 132Kw 180CV 1781cc, 1.8 T quattro 110Kw 150CV 1781cc/TT (8N3) 1.8 T 132Kw 180CV 1781cc/TT Roadster (8N9) 1.8 T 132Kw 180CV 1781cc, 1.8 T 110Kw 150CV 1781cc;

SEAT: ALHAMBRA (7V8, 7V9) 1.8 T 20V 110Kw 150CV 1781cc, 2.0 i 85Kw 115CV 1984cc, 2.8 V6 150Kw 204CV 2792cc, 2.8 V6 4motion 150Kw 204CV 2792cc/AROSA (6H) 1.0 37Kw 50CV 999cc, 1.4 44Kw 60CV 1390cc, 1.4 16V 74Kw 100CV 1390cc/IBIZA IV (6L1) 1.2 47Kw 64CV 1198cc, 1.4 16V 74Kw 100CV 1390cc, 1.4 16V 55Kw 75CV 1390cc/LEON (1M1) 1.4 16V 55Kw 75CV 1390cc, 1.6 74Kw 100CV 1595cc, 1.6 16V 77Kw 105CV 1598cc, 1.8 20V 92Kw 125CV 1781cc, 1.8 20V T 132Kw 180CV 1781cc, 1.8 20V T 4 132Kw 180CV 1781cc, 2.8 Cupra 4 150Kw 204CV 2792cc/TOLEDO II (1M2) 1.4 16V 55Kw 75CV 1390cc, 1.6 74Kw 100CV 1595cc, 1.6 16V 77Kw 105CV 1598cc, 1.8 20V 92Kw 125CV 1781cc, 1.8 20V T 132Kw 180CV 1781cc, 2.3 V5 20V 125Kw 170CV 2324cc;

SKODA: FABIA (6Y2) 1.0 37Kw 50CV 996cc, 1.2 40Kw 54CV 1198cc, 1.2 47Kw 64CV 1198cc, 1.4 50Kw 68CV 1397cc, 1.4 44Kw 60CV 1397cc, 1.4 16V 74Kw 100CV 1390cc, 1.4 16V 55Kw 75CV 1390cc, 2.0 85Kw 116CV 1984cc/FABIA Combi (6Y5) 1.2 47Kw 64CV 1198cc, 1.4 50Kw 68CV 1397cc, 1.4 44Kw 60CV 1397cc, 1.4 16V 55Kw 75CV 1390cc, 1.4 16V 74Kw 100CV 1390cc, 2.0 85Kw 116CV 1984cc/FABIA Praktik 1.2 47Kw 64CV 1198cc, FABIA Stufenheck (6Y3) 1.2 47Kw 64CV 1198cc, 1.2 40Kw 54CV 1198cc, 1.4 50Kw 68CV 1397cc, 1.4 44Kw 60CV 1397cc, 1.4 16V 55Kw 75CV 1390cc, 2.0 85Kw 116CV 1984cc, OCTAVIA (1U2) 1.4 44Kw 60CV 1397cc, 1.4 16V 55Kw 75CV 1390cc, 1.6 55Kw 75CV 1598cc, 1.6 74Kw 101CV 1595cc, 1.6 75Kw 102CV 1595cc, 1.8 92Kw 125CV 1781cc, 1.8 T 110Kw 150CV 1781cc, 1.8 T 4x4 110Kw 150CV 1781cc, 2.0 85Kw 116CV 1984cc, RS 1.8 T 132Kw 180CV 1781cc/OCTAVIA Combi (1U5) 1.4 16V 55Kw 75CV 1390cc, 1.6 74Kw 101CV 1595cc, 1.6 55Kw 75CV 1598cc, 1.6 75Kw 102CV 1595cc, 1.8 20V 92Kw 125CV 1781cc, 1.8 T 110Kw 150CV 1781cc, 1.8 T 4x4 110Kw 150CV 1781cc, 2.0 85Kw 116CV 1984cc, 2.0 4x4 88Kw 120CV 1984cc, 2.0 4x4 85Kw 116CV 1984cc, RS 1.8 T 132Kw 180CV 1781cc/SUPERB (3U4) 1.8 T 110Kw 150CV 1781cc, 2.0 85Kw 115CV 1984cc, 2.8 V6 142Kw 193CV 2771cc;

VOLKSWAGEN: PASSAT (3B3) 1.6 75Kw 102CV 1595cc, 1.8 T 125Kw 170CV 1781cc, 1.8 T 20V 110Kw 150CV 1781cc, 2.0 85Kw 115CV 1984cc, 2.0 96Kw 130CV 1984cc, 2.3 V5 125Kw 170CV 2324cc/PASSAT Variant (3B6) 1.6 75Kw 102CV 1595cc, 1.8 T 20V 110Kw 150CV 1781cc, 2.0 85Kw 115CV 1984cc, 2.0 96Kw 130CV 1984cc, 2.3 VR5 125Kw 170CV 2324cc/SHARAN (7M8, 7M9, 7M6) 1.8 T 20V 110Kw 150CV 1781cc, 2.0 85Kw 115CV 1984cc, 2.8 V6 24V 150Kw 204CV 2792cc, 2.8 V6 24V 4motion 150Kw 204CV 2792cc, 2.8 VR6 128Kw 174CV 2792cc, 2.8 VR6 Syncro 128Kw 174CV 2792cc, GOLF / JETTA 00-04;



GI4303

FEATURES / CARACTERÍSTICAS: 12V 3.0 BAR 95 L/H

REPLACES / REEMPLAZA:

BOSCH: 0 580 453 922; **VDO:** 9850007, E22-041-077; **PIERBURG:** 7.20802.52.0; **VW:**1H0906091D, 1H0919051AC, 535919051D

APPLICATION / APLICACIÓN:

SEAT: CORDOBA 1.6L, IBIZA II 1.0L TOLEDO I 1.98L;

VOLKSWAGEN: GOLF III 1.4/1.6L, PASSAT I 1.8L, POLO CLASSIC 1.6L, VENTO 1.4/1.6L



GI4304

FEATURES / CARACTERÍSTICAS: 12V 3.0 BAR 90L/H

REPLACES / REEMPLAZA:

AIRTEX: E10243, E8132, E8256; **BOSCH:** 0580 453 071, 0580 453 081; **VDO:** 405-054-002-001Z; **MAPCO:** 22885; **PIERBURG:** 7.18259.50.0; **VDO:** 405-052-003-001Z, 405-052-003-002Z; **VW:** 441906091E, 8A0906091G/A;

APPLICATION / APLICACIÓN:

AUDI: 80 (8C, B4) 1.6L/ 2.0L/ 2.6L/ 2.8L 06/93>12/94, A4 (8D2, B5) 1.6 01/95>07/00, A6 (4A, C4) 2.0 06/94>02/97, 200 AVANT (44, 44Q) 2.2 20V TURBO QUATTRO 07/89>12/90



GI4304A

FEATURES / CARACTERÍSTICAS: 12V 3.0 BAR 100L/H

REPLACES / REEMPLAZA:

AIRTEX: E10243, E8256; **BOSCH:** 0 580 310 006, 0 580 310 007, 0 580 314 068, 0 580 453 041, 0 580 453 046, 0 580 453 054, 0 580 453 058, 0 580 453 060, 0 580 453 070, 0 580 453 081; **PIERBURG:** 7.18259.50.0; **VDO:** 405502002001Z, 405052003002Z, 405.052.3.1; **VW:** 400906091, 400906091C, 8A0906091G/A

APPLICATION / APLICACIÓN:

FORD: FALCON EA,EB,ED 87-93;

AUDI: A6(4A,C4) 1.8 12/95-02/97

GI4304TT // NEW //

FEATURES / CARACTERÍSTICAS:

REPLACES / REEMPLAZA:

BMW: 16141178839, 16141180318, 16141182842

APPLICATION / APLICACIÓN:

BMW: 5(E28) (1980/06-1987/12), 5 Touring (E34) (1991/11-1997/01), 5(E34) (1987/12-1995/11), 7 Saloon (E32) 1986/09-1994/09



GI4305

FEATURES / CARACTERÍSTICAS: 12V 0.24BAR 110L/H 1.1A

REPLACES / REEMPLAZA:

AIRTEX: E10241; **PIERBURG:** 7.21088.62.0; **VDO:** E22-041-013Z, E22-041-065, E22-057-009Z; **VW:** 191 906092A, 191 906092C, 191 906092G, 357906092C, 533906092N, 533906092P; **MD:** 76407; **ERA:** 770039; **AUDI:** 191906092A, 191906092C, 191906092G, 191906092M, 357906092C, 533906092N, 191906092G, 191906092M, 357906092C, 533906092P; **BMW:** 16141180058; **MERCEDES-BENZ:** 14703194; S.I.D.A.T. S.r.l.: 70010; **SEAT:** 191906092A, 191906092C, 191906092G, 191906092M, 357906092C, 533906092N, 533906092P; **VOLKSWAGEN:** 191906092A, 191906092C, 191906092G, 191906092M, 357906092C, 533906092N, 533906092P, E22041009, E22041065

APPLICATION / APLICACIÓN:

SEAT: TOLEDO I (1L) 1.8 16V 05/91-09/96, IBIZA I (021A) 1.2L 01/89-05/93;

FORD USA: AEROSTAR 3.0 i V6 108Kw 147CV 2986cc; **MERCEDES-BENZ:** C-CLASS (W203) C 32 AMG Kompressor (203.065) 260Kw 354CV 3199cc/ C-CLASS T-Model (S203) C 32 AMG Kompressor (203.265) 260Kw 354CV 3199cc/ SL (R230) 55 AMG (230.474) 350Kw 476CV 5439cc, 55 AMG Kompressor (230.474) 368Kw 500CV 5439cc; **SEAT:** IBIZA I (021A) 1.2 i 52Kw 71CV 1193cc, 1.5 i 74Kw 100CV 1461cc, 1.5 i 65Kw 89CV 1461cc, 1.5 i KAT 66Kw 90CV 1461cc, 1.7 76Kw 103CV 1675cc, 1.7 72Kw 98CV 1675cc/ TOLEDO I (1L) 1.6 i 54Kw 73CV 1595cc, 1.6 i 52Kw 71CV 1595cc, 1.6 i 55Kw 75CV 1595cc, 1.8 16V 98Kw 133CV 1781cc, 1.8 16V 92Kw 125CV 1781cc, 1.8 i 65Kw 88CV 1781cc, 1.8 i 66Kw 90CV 1781cc, 2.0 i 85Kw 115CV 1984cc, 2.0 i 16V 110Kw 150CV 1984cc; **VOLKSWAGEN:** CORRADO (53I) 1.8 G60 118Kw 160CV 1781cc/ GOLF I (17) 1.8 GTI 82Kw 112CV 1781cc/ GOLF I Cabriolet (155) 1.8 82Kw 112CV 1781cc/ GOLF II (19E, 1G1) 1.8 GTI 82Kw 112CV 1781cc, 1.8 GTI 16V 95Kw 129CV 1781cc, 1.8 GTI 16V 102Kw 139CV 1781cc, 1.8 i KAT 66Kw 90CV 1781cc, 1.8 i Syncro KAT 66Kw 90CV 1781cc, 1.8 Syncro 66Kw 90CV 1781cc/ PASSAT (3A2, 35I) 1.8 82Kw 112CV 1781cc, 1.8 66Kw 90CV 1781cc, 1.8 16V 100Kw 136CV 1781cc, 2.0 16V 100Kw 136CV 1984cc, PASSAT Variant (3A5, 35I) 1.8 82Kw 112CV 1781cc, 1.8 66Kw 90CV 1781cc, 1.8 16V 100Kw 136CV 1781cc, 2.0 16V 100Kw 136CV 1984cc, POLO (86C, 80) 1.0 29Kw 40CV 1043cc, 1.0 33Kw 45CV 1043cc, 1.0 KAT 33Kw 45CV 1043cc, 1.1 37Kw 50CV 1093cc, 1.3 44Kw 60CV 1272cc, 1.3 40Kw 55CV 1272cc, 1.3 55Kw 75CV 1272cc, 1.3 D 33Kw 45CV 1272cc, 1.3 KAT 40Kw 55CV 1272cc, 1.3 KAT 55Kw 75CV 1272cc, 1.4 D 35Kw 48CV 1398cc/ POLO Coupe (86C, 80) 1.0 29Kw 40CV 1043cc, 1.0 33Kw 45CV 1043cc, 1.0 KAT 33Kw 45CV 1043cc, 1.1 37Kw 50CV 1093cc, 1.3 44Kw 60CV 1272cc, 1.3 40Kw 55CV 1272cc, 1.3 55Kw 75CV 1272cc, 1.3 57Kw 78CV 1272cc, 1.3 D 33Kw 45CV 1272cc, 1.3 G40 85Kw 115CV 1272cc, 1.3 G40 83Kw 113CV 1272cc, 1.3 KAT 40Kw 55CV 1272cc, 1.3 KAT 55Kw 75CV 1272cc, 1.4 D 35Kw 48CV 1398cc/ SCIROcc, O (53B) 1.6 53Kw 72CV 1595cc, 1.8 66Kw 90CV 1781cc, 1.8 82Kw 112CV 1781cc, 1.8 16V 102Kw 139CV 1781cc, 1.8 16V 95Kw 129CV 1781cc.



GI4306

FEATURES / CARACTERÍSTICAS: 12V 3.0 BAR 85 L/H

REPLACES / REEMPLAZA:

GM: 251-76107, 253-30836; **PIERBURG:** 7.21.088.52, 7.21.088.62; **DELPHI:** 25330836

APPLICATION / APLICACIÓN:

JINGBEI;

CHEVROLET: BLAZER



GI4306A

FEATURES / CARACTERÍSTICAS: 12V 3.0 BAR 85 L/H

REPLACES / REEMPLAZA:

-

APPLICATION / APLICACIÓN:

FORD



GI4307

FEATURES / CARACTERÍSTICAS: 12V 1.1BAR 110L/H 3.5A

REPLACES / REEMPLAZA:

MD: 76514/1; **ERA:** 770048; **BOSCH:** 0 580 314 152, 0 580 314 165, 0 580 453 502, 0 580 453 514, 0 580 454 072; **CITROËN/PEUGEOT:** 1450 91, 96 007 671; **FIAT:** 7555130, 7799543; **MAGNETI MARELLI:** 217555130000, ESS514; **OPEL:** 8 15 010, 90 272 744, 96 007 671; **RENAULT:** 60 00 581 612

APPLICATION / APLICACIÓN:

CITROËN: AX, BX, C15, XM;

FIAT: BRAVA, BRAVO, FIORINO, FIORINO Pick up, MAREA, PANDA, REGATA, RITMO, TEMPRA, TIPO, UNO;

INNOCENTI: ELBA;

LANCIA: DEDRA, Y10;

OPEL: ASCONA, KADETT;

PEUGEOT: 205, 309.



GI4307A

FEATURES / CARACTERÍSTICAS: 12V 1.1BAR 110L/H 3.5A

REPLACES / REEMPLAZA:

BOSCH: 0580 453 500, 0580 453 502, 0580453509, 0580453516; **OPEL:** 815012, 90297153, 90297154, 90322493

APPLICATION / APLICACIÓN:

OPEL: ASTRA 16V 1.4L 03/98, ASTRA 1.6L 09/98, ASTRA 16V 1.6L 03/98, ASTRA OPC 16V 2.0L 09/99, VECTRA 16V 1.6/1.8L 09/95, VECTRA 2.0L 09/95, VECTRA 2.0/2.2/2.5L 05/97, ASTRA 16V 2.0L 09-99;

PEUGEOT: 205 I, 205 II, 309 I, 309 II



GI4308

FEATURES / CARACTERÍSTICAS: 12V 4.0 BAR 100L/H

REPLACES / REEMPLAZA:

AC DELCO: EP453; **AIRTEX:** E10256; **BOSCH:** 0580-453-053; **BMW:** 1182842, 1182985, 1183139, 6758736, 16141 182842, 1614.1.182.985; **PIERBURG:** 7.22292.50.0; **DELPHI:** FE0235; **KEM:** EFP3304

APPLICATION / APLICACIÓN:

BMW: (E36) 316I 1.59L 09/90-09/93, (E36) 323 2.49L 09/90-09/95, (E36) 320I 1.99L 09/90-02/98, (E36) 318I 1.79L 12/90-10/93, COUPE (E36) 318IS 1.79L 03/92-10/95, COUPE (E36) 325I 2.49L 03/92-04/99, COUPE (E36) 320I 1.99L 03/92-04/99, CONVERTIBLE (E36) 325I 2.49L 03/93-03/95, (E36) 318IS 1.79L 03/93-09/97, (E36) 316I 1.59L 09/93-02/98, COUPE (E36) 316I 1.59L 09/93-04/99, (E36) 318I 1.79L 10/93-02/98, CONVERTIBLE (E36) 316I 1.59L 03/94-08/00, CONVERTIBLE (E36) 318TI 1.79L 11/94-08/95, (E36) 318I 2.79L 01/95-02/98, COUPE (E36) 328I 2.79L 01/95-04/99, COUPE (E36) 320I 1.99L 01/95-10/99, CONVERTIBLE (E36) 328I 2.79L 03/95-04/99;

VOLVO: 2.4L 02/93-12/95



GI4309

FEATURES / CARACTERÍSTICAS: 12V 4.0 BAR 100L/H

REPLACES / REEMPLAZA:

AIRTEX: E10257; **BMW:** 1614.4.183.604; **PIERBURG:** 7.21651.60.0, 7.21833.01.0, 7.21913.00.0, 7.21913.50.0

APPLICATION / APLICACIÓN:

BMW: 5 TOURING (E34) 520 L 11/91-01/97, 5 TOURING (E34) 525 L 11/91-01/97, 5 TOURING (E34) 518 L 09/94-01/97, 5 (E34) 520 L 01/88-08/91, 5 (E34) 520 L 24V 09/89-09/95, 5 (E34) 525 L 01/88-08/91, 5 (E34) 518 L 08/89-09/95, 7 (E32) 730 L/LL 12/86-09/94, 7 (E32) 735 L/LL 09/86-12/87, 7 (E32) 740 L/LL V8 04/92-09/94



GI4310

FEATURES / CARACTERÍSTICAS: 12V 3.0 BAR 100L/H

REPLACES / REEMPLAZA:

BMW: 16141183947, 16141182109, 16141182355

APPLICATION / APLICACIÓN:

BMW: 7 (E38)



GI4311

FEATURES / CARACTERÍSTICAS: 12V 3.0 BAR 100L/H

REPLACES / REEMPLAZA:

VDO: 228222005004; **BMW:** 16141182887

APPLICATION / APLICACIÓN:

BMW: 3 SERIES COMPACT(E36) 1.6L/1.8L/1.9L/2.5L 94-00



GI4313

FEATURES / CARACTERÍSTICAS: 12V 3.0 BAR 100L/H

REPLACES / REEMPLAZA:

BOSCH: 0580810019, 0580453911; **FIAT:** 60537611; **JEEP:** 8933063591; **PEUGEOT:** 145083; **RENAULT:** 7700739914

APPLICATION / APLICACIÓN:

CHEROKEE: 4.0L 09/90-08/99;

GM: 4.0L 08/90-08/95;

BMW;

PASSAT;

WRANGLER: 4.0L 08/90-08/95;

VW: PASSAT;

JEEP: 4.0L 01/88



GI4315B

FEATURES / CARACTERÍSTICAS: 12V 3.0BAR 90L/H 6.2A

REPLACES / REEMPLAZA:

BOSCH: 0580453966, 0580453981, 0580314097, 0580453966, 0580453976, 0580453984, 0580453985; **MAPCO:** 22714; **FIAT:** 7796614; **OPEL:** 815091, 90442231

APPLICATION / APLICACIÓN:

CHEVROLET: ASTRA 94-98, VECTRA 95-98, VECTRA CD 16V 2.0L 04-96, VECTRA GST 16V 2.0L 10-93, VECTRA 2.0L 10-93;

GM: ASTRA 2.0MPFL 95->, ASTRA 2.0 8V 10/93-03/96, ASTRA 2.0 16V 10/93, ASTRA CD 2.0 MPFL 8V 10/93-03/96;

OPEL: ASTRA 1.4L 93-96, ASTRA 2.0L 91-96, ASTRA 1.6L 94-96, ASTRA 1.4L 94-95, ASTRA 2.0L 94-95;

FIAT: PUNTO 176 1.4GT TURBO 01/94-09/96



GI4317

FEATURES / CARACTERÍSTICAS: 12V 0.1 BAR 80L/H

REPLACES / REEMPLAZA:

NISSAN: 17042-51201, 17042-51L01, 17042-V7300, 17042-VT200, A223283016; OPEL: 815091

APPLICATION / APLICACIÓN:

TSURU III GS 1.6L 92



GI4319

FEATURES / CARACTERÍSTICAS: 3 BAR, 95L/H - Gasoline/ Diesel

REPLACES / REEMPLAZA:

VW: 4B0906091A; HYUNDAI: 311102B960, 311112D460, 311112D450, 311112D410; KIA: 311112E960, 311101D200, 311102G560;

KLAXCAR - FRANCE: 44021z

APPLICATION / APLICACIÓN:

LAND ROVER: Defender 110 3.5 4x4 1990>1998, Discovery Mk1 2.0 16v 4x4 / 2.5 TDI 4x4 1989>1998; VOLKSWAGEM: Passat MK5 Saloon 1.8 1996>2000; HYUNDAI: Accent Mk2 hatch 1.5 2002>2005, Elantra Mk3 hatch 2.0 2001>2006, Getz hatch 1.5 2003>2005, Matrix MPV 1.5 2004>2010, Tucson 2.0 2004>2010; KIA: Sportage Mk2 2.0 2004>



GI4322 // NEW //

FEATURES / CARACTERÍSTICAS: Gasoline/ Diesel

REPLACES / REEMPLAZA:

VW: 1J0 919 050, 1J0 919 050 B

APPLICATION / APLICACIÓN:

VW: POLO (9N-) (2001/10-2012/01);

SKODA: FABIA (6Y2) (99/08>08/03)



GI4324

FEATURES / CARACTERÍSTICAS: 12V 3BAR 105L/H 7A

REPLACES / REEMPLAZA:

MERCEDES-BENZ: 4704994, 4705494, 4706394; ROBERT BOSCH GMBH: 0 986 580 371; S.I.D.A.T. S.r.l.: 70073; VALEO SERVICE DEUTSCHLAND GMBH: 347307

APPLICATION / APLICACIÓN:

MERCEDES-BENZ: C-CLASS (W202) C 180 (202.018) 90Kw 122CV 1799cc, C 200 (202.020) 100Kw 136CV 1998cc, C 220 (202.022) 110Kw 150CV 2199cc, C 230 (202.023) 110Kw 150CV 2295cc, C 240 (202.026) 125Kw 170CV 2398cc, C 280 (202.028) 142Kw 193CV 2799cc, C 280 (202.029) 145Kw 197CV 2799cc/ C-CLASS Kombi (S202) C 180 T (202.078) 90Kw 122CV 1799cc, C 200 T (202.080) 100Kw 136CV 1998cc, C 230 T (202.083) 110Kw 150CV 2295cc, C 240 T (202.086) 125Kw 170CV 2398cc, C 280 T (202.089) 145Kw 197CV 2799cc/ CLK (C208) 200 (208.335) 100Kw 136CV 1998cc, 200 Kompressor (208.344) 120Kw 163CV 1998cc, 230 Kompressor (208.348) 145Kw 197CV 2295cc, 320 (208.365) 160Kw 218CV 3199cc/ CLK Cabriolet (A208) 200 (208.435) 100Kw 136CV 1998cc, 200 Kompressor (208.444) 120Kw 163CV 1998cc, 230 Kompressor (208.448) 145Kw 197CV 2295cc, 320 (208.465) 160Kw 218CV 3199cc.



GI4326

FEATURES / CARACTERÍSTICAS: 12V 3.0 BAR 80L/H

REPLACES / REEMPLAZA:

OE: 191906091J, 191906091C, 191906091H, 191906090; BOSCH: 0580254033, 05804530979; VW: 191906090, 191906091E; AIRTEX: E8030

APPLICATION / APLICACIÓN:

VW: GOLF II 1.8L 83-91, JETTA II 1.8L 84-91, PASSAT 1.8L, 2.0L 88-93, CORRADO 1.8L, 2.0L 91-99;

SEAT: TOLEDO



GI4327

FEATURES / CARACTERÍSTICAS: 12V 3.0 BAR 100L/H

REPLACES / REEMPLAZA:

PIEBURG: 7.22426.01.0

APPLICATION / APLICACIÓN:

FORD: IKON, FIESTA IV 1.3L 08/95-01/02



GI4328

FEATURES / CARACTERÍSTICAS: 12V 4.0 BAR 110L/H

REPLACES / REEMPLAZA:

BOSCH: 0580 254 040, 0580 254 036, 0580 464 988, 0580 464 991F; PIEBURG: 7.21651.50.0, 4.05295.24.0, 4.05295.25.0, 4.05295.28.0, 7.21651.10.0, 7.21651.60.0; VW: 441906091A, 441906091B, 443906087BE, 443906091E, 895906089E, 895906091, 895906091A; AUDI: 4A0906087AA, 4A0906087AC, 4A0906087K, 4A0906087L, 4A0906087S, 4A0906087K, 4A0906091B, 895906089D, 895906089E, 895906091B, 895906091F

APPLICATION / APLICACIÓN:

AUDI: A6 2.016V, A6 2.3, A6 QUATTRO 2.0 16V, A6 QUATTRO 2.3, 80 100 200 COUPE, AVANTR2 S6 4.2V V8 32V, 80 2.0E 16V, 80 QUATTRO 2.0 100 QUATTRO 2.2E, 100 QUATTRO 2.2E TURBO, 100 QUATTRO 2.3E, 200 2.2 TURBO, 200 2.3, 200 QUATTRO 2.2 TURBO





GI4329

FEATURES / CARACTERÍSTICAS: 12V 3.0 BAR 100L/H

REPLACES / REEMPLAZA:

BOSCH: 0580453021, 0580453040; **PIERBURG:** 7.21913.500; **BMW:** 16141180318, 16141178839, 16141181354

APPLICATION / APLICACIÓN:

BMW: 525i (E34), 520i (E32), 735 (E34), 518i 520 525i 318ESTATE (E34)



GI4332

FEATURES / CARACTERÍSTICAS: 12V 4.0 BAR 110L/H

REPLACES / REEMPLAZA:

PIERBURG: 7.22156.50.0, 7.21960.01.0, 7.21960.01.1, 7.21960.04.0, 7.21960.51.0, 7.21960.54.0, 7.22156.00.0, 7.22156.00.1, 7.22156.00.2, 7.22156.01.0, 7.22359.00.0, 7.22359.00.1, 7.22473.00.0, 7.22542.00.0, 7.22542.01.0; **AIRTEX:** E10246; **BENZ:** 0004705994, 0004706094, 0004706794, 0004707894, 0004709594, 0004780001, 2024709994

APPLICATION / APLICACIÓN:

MERCEDES BENZ: C-KLASSE C180(202) 06.93-02.01, C-KLASSE C200(202) 01.94-02.00, C-KLASSE C200KOMPRESSOR(202) 09.95-02.01, C-KLASSE C220(202) 03.93-09.96, C-KLASSE C43AMG(202) 10.97-04.00, CLK 2000KOMPRESSOR(208) 06.97-06.00, CLK 230KOMPRESSOR(208) 06.97-06.00, CLK 320(208) 06.97-06.02, E-KLASSE E240(210) 9, 97, E-KLASSE E280(124) 07.93-05.96, E-KLASSE E280(210) 1, 96, E-KLASSE E300(124) 07.93-06.95, E-KLASSE E500(124) 07.93-06.95, E-KLASSE E55 AMG(210) 9, 97, G 300(463) 08.93-10.94, S-KLASSE S280 06.93-09.98, S-KLASSE S280(220) 10, 98, S-KLASSE S320(140) 03.93-09.98, SL-KLASSE SL280(129); 07.93-05.98, SL-KLASSE SL280(129) 06.98-08.01, SLK-KLASSE SLK200(170) 09.96-01.00, SLK-KLASSE SLK200KOMPRESSOR(170) 9, 96, SLK-KLASSE SLK230KOMPRESSOR(170) 09.96-01.00



GI4332A

FEATURES / CARACTERÍSTICAS: 12V 4.0 BAR 110L/H

REPLACES / REEMPLAZA:

BENZ: 14701294; **PIERBURG:** 7.28126.51.0

APPLICATION / APLICACIÓN:

MERCEDES: W220



GI4334

FEATURES / CARACTERÍSTICAS: 12V 4.0 BAR 100L/H

REPLACES / REEMPLAZA:

PIERBURG: 7.22013.01.0, 7.33013.04; **BMW:** 16141183176, 16141183216, 16146752368

APPLICATION / APLICACIÓN:

BMW: 520i24V(E34) 09.89-08.92, 520i24V(E34) 09.92-12.96, 520i 2.024V(E39) 09.95-09.00, 520i 2.2 24V(E39) 09-00, 523i24V(E39) 09.95-09.00, 530i24V(E39) 09-00, 535iV832V(E39) 1, 96



GI4335

FEATURES / CARACTERÍSTICAS: 12V 3.0 BAR 95L/H

REPLACES / REEMPLAZA:

BOSCH: 0.580.453.021, 0.580.453.016

APPLICATION / APLICACIÓN:

VW: PASSAT B3/ B6



GI4336

FEATURES / CARACTERÍSTICAS: 12V 3.0 BAR 100L/H

REPLACES / REEMPLAZA:

BOSCH: 580453911; **FIAT:** 6053T611; **PEUGEOT:** 91539329; **OE:** 7700739914

APPLICATION / APLICACIÓN:

ALFA ROMEO: 31.4IE 09.91-12.91, ESPACE2.0I QUADRA 01.88-12.90



GI4337

FEATURES / CARACTERÍSTICAS: 12V 3.0 BAR 130L/H

REPLACES / REEMPLAZA:

AIRTEX: E3947

APPLICATION / APLICACIÓN:

CHEVROLET: C2500 PICKUP V8 5.7L 350cid GAS FI N Engine VIN = R, K2500 PICKUP V8 5.7L 350cid GAS FI N Engine VIN = R ;

GMC: C2500 PICKUP V8 5.7L 350cid GAS FI N Engine VIN = R, K2500 PICKUP V8 5.7L 350cid GAS FI N Engine VIN = R



GI4339

FEATURES / CARACTERÍSTICAS: 12V 4.0 BAR 100L/H

REPLACES / REEMPLAZA:

AIRTEX: E10363; **PIERBURG:** 21283.00.0, 7.21283.50.0, 7.21283.60.0, 7.21283.53.0 7.21682.00.1, 7.21682.50.0; **BENZ:** A0004704194 A0004704294 0004704194 0004704294; **SIDAT-FISPA:** 70072

APPLICATION / APLICACIÓN:

BMW: MERCE 190(W201) E2.5-16 09.88-08.93

GI4343

FEATURES / CARACTERÍSTICAS: 13V 4.0 BAR 150L/H

REPLACES / REEMPLAZA:

MERCEDES BENZ: A2214708494, A2214705994, 2214705994; VDO: 993762208

APPLICATION / APLICACIÓN:

CHRYSLER



GI4345 // NEW //

FEATURES / CARACTERÍSTICAS: Gasoline

REPLACES / REEMPLAZA:

AUDI: 3B0906019

APPLICATION / APLICACIÓN:

AUDI: A4(8D2, B5) (1994/11-2001/09), A6 (4B2,C5) (1197/01-2005/01), A6 Avant (4B5,C5)(1997/11-2005/01), A4 Avant (8D5,B5)(1994/11-2001/09)



GI4601

FEATURES / CARACTERÍSTICAS: 12V 4.0 BAR 110L/H

REPLACES / REEMPLAZA:

AIRTEX: E8002; SPECTRA: SP1207

APPLICATION / APLICACIÓN:

JAGUAR: VANDEN PLAS L6-3.6L 88>89, XJ6 L6-3.6L 88>89; VOLVO: 240 L4-2.3L 90>93



GI4601B

FEATURES / CARACTERÍSTICAS: 12V 4.0BAR 115L/H

REPLACES / REEMPLAZA:

AIRTEX: E8177, E8305, E8307; SPECTRA: SP1171, SP1245PRO, SP1263PRO

APPLICATION / APLICACIÓN:

MERCEDES-BENZ: 190E L4-2.3L; AUDI: 4000 LE-1.6 80-87; PORSCHE: 911 H6-3.6L 89-98; VOLKSWAGEN: FPX L4-1.8L 87-91



GI4601C

FEATURES / CARACTERÍSTICAS: 12V 3.0BAR 75L/H

REPLACES / REEMPLAZA:

AIRTEX: E2236; SPECTRA: SP1125

APPLICATION / APLICACIÓN:

FORD: E-350 V8-7.3L 03



GI4601D

FEATURES / CARACTERÍSTICAS: 12V 4.0BAR 125L/H

REPLACES / REEMPLAZA:

AIRTEX: EE8314; SPECTRA: SP1160

APPLICATION / APLICACIÓN:

MERCEDES-BENZ: 190E L4-2.3L 93>91



GI4601E

FEATURES / CARACTERÍSTICAS: 12V 2.5 BAR 80L/H

REPLACES / REEMPLAZA:

AIRTEX: E8000; SPECTRA: SP1186

APPLICATION / APLICACIÓN:

DODGE: Colt L4-1.6L 1984, Conquest L4-2.6L 84-86; HONDA: Accord L4-1.8L 1985; MAZDA: RX-7 R2-1.3L 84-85; MITSUBISHI: Starion L4-2.6L 83-89; TOYOTA: Celica L4-2.0L 83-84, Cressida L6-2.6L 1980



GI4601F

FEATURES / CARACTERÍSTICAS: 12V 2.5 BAR 85L/H

REPLACES / REEMPLAZA:

AIRTEX: E8312; SPECTRA: SP1188

APPLICATION / APLICACIÓN:

ISUZU: Impulse L4-1.9L 83>86; NISSAN: 200SX L4-2.0L 80>81, Stanza L4-2.0L 84>88; OPEL: 1900 L4-1.9L 75; SUBARU: GL H4-1.8L 83>86, XT H6-2.7L 88>94





GI4601G

FEATURES / CARACTERÍSTICAS: 12V 2.5 BAR 85L/H

REPLACES / REEMPLAZA:

AIRTEX: E2182; SPECTRA: SP1165

APPLICATION / APLICACIÓN:

FIAT: 124 L4-2.0L 83-81, Brava L4-2.0L 1981; FORD: Country Squire V8-5.0L 91-87; LINCOLN: Continental V8-5.0L 1980; MERCURY: Colony Park V8-5.0L 91-87; TRIUMPH: TR7 L4-2.0L 81-80



GI4601-2F

FEATURES / CARACTERÍSTICAS: 12V 4.0 BAR 115L/H

REPLACES / REEMPLAZA:

AIRTEX: E2315; SPECTRA: SP1252

APPLICATION / APLICACIÓN:

BMW: 2002TII L4-2.0L 72-74; CADILLAC: Commercial chassis V8-7.0L 77-78; DODGE: Charger L4-2.2L 85-87; FORD: Escort L4-1.6L 83-85; MERCURY: LN7 L4-1.6L 83



GI4601-2G

FEATURES / CARACTERÍSTICAS: 12V 0.6 BAR 130L/H

REPLACES / REEMPLAZA:

AIRTEX: E8094; SPECTRA: SP1175

APPLICATION / APLICACIÓN:

CHRYSLER: Imperial V8-5.2L



GI4601-3F

FEATURES / CARACTERÍSTICAS: 12V 4.0 BAR 125L/H

REPLACES / REEMPLAZA:

AIRTEX: E8145; SPECTRA: SP1266PRO

APPLICATION / APLICACIÓN:

DELOREAN: DMC 12 V6-2.9L 81; MERCEDES-BENZ: 280SE L6-2.8L 71-72



GI5001

FEATURES / CARACTERÍSTICAS: 12V 3.0 BAR 100L/H

REPLACES / REEMPLAZA:

AC DELCO: EP425, EP433, EP454; AIRTEX: E3222, E8023, E8235; BOSCH: 0.580.464.074; ISUZU: 8-97019-185-0; KEM: EFP8023, EFP8230, EFP8119; NISSAN: 17042-62E00, 17042-96E00, 17042-30R00, 17042-40F00, 17042-40R00, 17042-70F00, 17042-96E10; TOYOTA: 230220-16070, 23220-06080, 23220-16083, 23220-16084, 23220-16190, 23220-16270, 23220-42070, 23220-43070, 23220-70170, 23220-79015, 23221-42130, 23221-50010, 23221-50020, 23221-74010

APPLICATION / APLICACIÓN:

BUICK: PARK AVENUE 3.8 01/91-12/92; HONDA: ACCORD IV (CB3, CB7) 2.2L 16V AUTOMATIC 01/90-03/93; MAZDA: RX 7 II (FC) WANKEL 11/85-04/89; MITSUBISHI: COLT III (C5_A) 1.5 GLXL (C52A) 04/88-05/92; SUZUKI: SWIFT II FASTBACK 1.3 GTL (SF413/AA34) 03/89-12/94; TOYOTA: LAND CRUISER 80 (J8) 4.0 (FJ80) 01/90-08/92, CAMRY SEDAN (V1) 2.0 GLL 01/85-10/86



GI5001A

FEATURES / CARACTERÍSTICAS: 12V 3.0 BAR 100L/H

REPLACES / REEMPLAZA:

AC DELCO: EP285; AIRTEX: E3285, E8255; DELPHI: FE0144, FE0146; KEM: EFP8119; FORD: 17708-SF1-A31, 17708-SG0-A31

APPLICATION / APLICACIÓN:

HONDA: 17708-SF1-931, 17708-SF1-933, 17708-SF1-A31, 17708-SG0-A31;

ISUZU: 8-97065-370-2, 8-97-069-336-1;

MAZDA: F201-13-350G;

MITSUBISHI: MB598285, MB678398;

NISSAN: 17042-96E00, 17042-62J00, 17042-70F00, 17042-96E10;

SUBARU: 42021-FA000, 42021-FA001, 42021-FA040;

SUZUKI: 15100-61B00, 15100-61B03, 15100-61BT0;

TOYOTA: 23221-42130, 23221-50010, 23221-50020, 23221-74010



GI5001B

FEATURES / CARACTERÍSTICAS: 12V 3.0 BAR 100L/H

REPLACES / REEMPLAZA:

DELPHI: FE0146; FORD: 17708-SF1-931, 17708-SF1-933, 17708-SF1-A31, 17708-SG0-A31, 17708-SH3-A31, 17708-SH3-A34; ISUZU: 8-97065-970-2, 8-97069-336-1; MAZDA: F201-13-350G; MITSUBISHI: MV598285, MB678398; NISSAN: 17042-96E00, 17042-62J00, 17042-70F00, 17042-96E10; SUBARU: 42021-FA000, 42021-FA001, 42021-FA040; SUZUKI: 15100-61B00, 15100-61B03, 15100-61BT0; TOYOTA: 23221-50010, 23221-50020, 23221-74010

APPLICATION / APLICACIÓN:

-

GI5005

FEATURES / CARACTERÍSTICAS: 12V 3.0 BAR 100L/H

REPLACES / REEMPLAZA:

AIRTEX: E8247, E8272; AC DELCO: EP454; NISSAN: 17042-1E300, 17042-62C00, 17042-71L02, 17042-73Y00, 17042-Q5601

APPLICATION / APLICACIÓN:

NISSAN: MICRA (K11) 1.0 L 16V 08/92-12/95, MICRA (K11) 1.3 L 16V 08/92-12/95;

INFINITI: G20 2.0 01/95-12/96;

NISSAN: 100 NX (B13) 1.6 03/90-10/94, 100 NX (B13) 2.0 GTL 03/91-10/94, PRIMERA (P10) 1.6 06/90-12/94, PRIMERA (P10) 2.0 16V 06/90-05/93, PRIMERA (P10) 2.0 GT 06/90-01/96, PRIMERA (P10) 2.0 L 01/95-06/96, PRIMERA (P10) 1.6 06/90-12/94, PRIMERA HATCHBACK (P10) 1.6 06/90-05/93, PRIMERA HATCHBACK (P10) 2.0 16V 06/90-05/93, PRIMERA HATCHBACK (P10) 2.0 L 01/95-06/96



GI5001KT

FEATURES / CARACTERÍSTICAS:

REPLACES / REEMPLAZA:

...

APPLICATION / APLICACIÓN:

ISUZU: TROOPER TODO TERRENO

MITSUBISHI: COLT II (C1_A) 1.6 TURBO ECL (C13A) 01/85-04/88, COLT II (C1_A) 1.6 TURBO ECL (C13A) 07/86-04/88, PAJERO I (L04_G / L14_G) 3.0 V6 (L141G/L146G) 11/88-11/90;

BUICK: PARK AVENUE 3.8 01/91-12/92;

DAIHATSU: CHARADE II (G11/ G30) 1.0 (G11) 10/83-03/87, CHARADE II (G11 / G30) 1.0 TURBO (G11) 10/83-03/87, CHARADE IV (G200 / G202) 1.3 16V 01/93->, CHARADE IV (G200 / G202) 1.3 09/96->, APPLAUSE I (A101 / A111) 1.6 16V (A101) 06/89-07/97, APPLAUSE I (A101 / A111) 1.6 16V 4WD (A111) 06/89-07/97, APPLAUSE I (A101 / A111) 1.6 16V (A101) 06/89-07/97, CHARADE III (G100 / G101 / G102) 1.0 GTL (G100) 03/87-12/92, CHARADE III (G100 / G101 / G102) 1.3 L (G102) 06/88-12/92, CHARADE III (G100/ G101/ G102) 1.3 L 4WD (G102) 06/88-01/93, CHARADE III SEDAN (G102) 1.3 (G102) 11/90-02/93;

HONDA: ACCORD IV (CB3/ CB7) 2.2 L 16V AUTOMATLK (CB7) 01/90-03/93, ACCORD IV (CB3/ CB7) 2.2 L 16V (CB7) 01/90-03/93, ACCORD III (CA4 CA5) 2.0 EXL (CA5) 01/86-12/89, CIVIC III SEDAN (ED) 1.6 L 16V (ED4) 01/89-09/91, CIVIC III SEDAN (ED) 1.6 L 16V 01/89-09/91, CIVIC III SE DAN (ED) 1.5 L 16V 01/89-09/91, CIVIC III HATCHBACK (EC/ ED/ EE) 1.6 L 16V (ED7) 01/89-09/91, CIVIC III HATCHBACK (EC/ ED/ EE) 1.5 L 16V (ED6) 01/89-09/91, CIVIC III HATCHBACK (EC/ ED/ EE) 1.6 L 16V 01/89-09/91, CRX II (ED/ EE) 1.6 L 16V (ED9) 01/89-12/89, PRELUDE III (BA) 2.0 L EX 16V (BA4) 04/90-01/92, PRELUDE III (BA) 2.0 L EX 16V 10/87-12/90, ACCORD IV AERODECK (CB8/ CC) 2.2 L 16V (CB8) 01/91-12/93, PRELUDE IV (BB) 2.3 L 16V (BB2) 02/92-09/96, PRELUDE IV (BB) 2.2 L 16V VTEC (BB1) 02/93-09/96;

MAZDA: RX 7 II (FC) WANKEL 11/85-04/89, RX 7 II (FC) TURBO 06/87-11/89, 929 III (HC) 3.0 01/88-12/89, 929 III (HC) 3.0 06/87-06/91, 323 III HATCHBACK (BF) 1.6 GT 09/87-10/89, 323 III HATCHBACK (BF) 1.6 GT 08/85-12/88, 323 III HATCHBACK (BF) 1.6 GT TURBO 4WD (BF2) 10/87-11/91, 323 III HATCHBACK (BF) 1.6 GT TURBO 4WD (BF2) 08/87-10/89, 323 III STATION WAGON (BW) 1.6 09/89-10/95, 323 III (BF) 1.6 GT 11/86-10/89, 323 C IV (BG) 1.6 09/89-06/91, 323 S IV (BG) 1.6 16V 08/89-10/94, 626 III COUPE (GD) 2.2 12V 04/88-12/91, 626 III (GD) 2.2 12V 11/87-07/91, MPV I (LV) 3.0 L V6 03/95-12/95, 626 III HATCHBACK (GD) 2.2 12V 06/88-04/92;

MITSUBISHI: COLT III (C5_A) 1.5 GLXL (C52A) 04/88-05/92, COLT III (C5_A) 1.6 GTL 16V (C53A) 04/88-05/90, GALANT III (E1_A) 2.4 GLS (E16A) 07/85-12/87, GALANT IV SEDAN (E3_A) 2.0 GTL 16V (E33A) 11/87-12/90, GALANT IV SEDAN (E3_A) 2.0 GTL 16V 4X4 06/88-12/90, GALANT IV SEDAN (E3_A) 2.0 4X4 (E38A) 12/88-12/90, GALANT IV SEDAN (E3_A) 2.0 (E33A) 11/87-12/90 12/88-12/90, GALANT IV SEDAN (E3_A) 2.0 GTL 16V x 12/88-12/90, GALANT IV (E3_A) 2.0 4X4 (E38A/E39A) 04/89-12/90, GALANT IV (E3_A) 2.0 GTL 16V (E33A) 11/88-12/90, GALANT IV (E3_A) 2.0 (E33A) 04/89-12/90, GALANT IV (E3_A) 2.0 GTL 16V 4X4 (E39A) 07/89-12/90;

ROVER: 800 825 SL/STERLLNG (XS) 10/86-10/88, 800 825 SL/STERLLNG (XS) 01/87-12/91, 800 827 SL/STERLLNG (XS) 02/88-12/91, 800 825 SL/STERLLNG (XS) CAT 10/86-12/91, 800 827 SL/STERLLNG (XS) CAT 02/88-02/99;

SUZUKI: SWIFT II FASTBACK (EA/ MA) 1.3 GTL (SF413/AA34) 03/89-12/94;

TOYOTA: LAND CRUISER 80 (_J8_) 4.0 (FJ80_) 01/90-08/92, MR 2 (_W1_) 1.6 16V (AW11) 11/84-06/90, SUPRA (MA70) 3.0 24V (DENSO) 01/86-08/88, SUPRA (MA70) 3.0 TURBO 09/87-12/91, SUPRA (MA70) 3.0 TURBO 08/88-12/91, 4 RUNNER (_N130) 3.0 V6 (VZN 130) 07/90-12/91, 4 RUNNER (_N130) 2.4 (RN61) 08/87-12/94, CAMRY SEDAN (V1) 2.0 GLL 01/85-10/86, CAMRY (_V2_) 2.0 (SV21_/SV25_) 11/86-05/91, CAMRY (_V2_) 2.0 GLL 16V (SV21_/SV25_) 11/86-05/91, CAMRY (_V2_) 2.5 V6 GXL (VZV21_) 02/88-05/91, CAMRY STATION WAGON (_V2_) 2.0 (SV21_) 11/86-05/91, CAMRY STATION WAGON (_V2_) 2.0 GLL 16V (SV21_) 11/86-05/91, CAMRY STATION WAGON (_V2_) 2.5 (VZV21_) 01/90-05/91, CELICA FASTBACK (T16) 2.0 GT 08/85-08/89, CELICA FASTBACK (T16) 2.0 GT 09/85-08/89, CELICA DESCAPOTABLE (_T16_) 2.0 GT (ST162) 10/86-08/90, CELICA COUPE (T16F) 2.0 TURBO 4X4 03/88-08/90, CELICA (ST16_) 2.0 01/87-08/90, PREVIA (TCR1_) 2.4 05/90-12/91, PREVIA (TCR1_) 2.4 4WD 05/90-12/91, CELICA SUPRA (MA61) 2.8 L 05/82-10/86, LAND CRUISER (_J6_) 4.0 (FJ62_G) 08/87-12/89;

FORD: USA PROBE I 2.2 GT 08/88-12/92, PROBE I 2.2 08/88-07/93;

LEXUS: ES (F1 F2) 250 12/89-09/91;

ACURA: LEGEND 2.7 01/87-08/91, LEGEND COUPE 2.7 01/87-08/91, LEGEND II 3.2 (SEDAN) 08/91-12/95;

ISUZU: ABIERTA (UBS) 2.6 L (UBS17) 10/87-12/91, TROOPER (UB) 3.2 01/92-12/93, ABIERTA (UB) 3.2 01/92-12/93, 200 SX (S13) 1.8 TURBO 09/88-11/93;

NISSAN: TERRANO II (R20) 2.4 L 12V 4WD 02/93-05/96, MAXIMA QX (A32) 3.0 01/95-08/00, 200 SX (S14) 2.4 L 10/93-12/98;

OPEL: MONTEREY A (UBS_) 3.2 (UBS25_) 06/92-12/93;

SUBARU: LEGACY II (BD BG) 2.2 L 4WD 09/94-12/98, LEGACY II (BD BG) 2.5 L 4WD 06/96-03/99, LEGACY II (BD BG) 2.2 L 4WD 06/96-12/98, IMPREZA (GC) 1.8 L 4WD 08/92-12/97, IMPREZA RANCHERA FAMILIAR (GF) 1.8 L 4WD 08/92-12/97, SVX (CX) 3.3 L 24V 4WD (CXW) 09/92-09/94, SVX (CX) 3.3 L 24V 4WD (CXW) 09/94-12/97, LEGACY II RANCHERA FAMILIAR (BD BG) 2.2 L 4WD 09/94-11/98, LEGACY II RANCHERA FAMILIAR (BD BG) 2.5 L 4WD 06/96-11/98, LEGACY II RANCHERA FAMILIAR (BD BG) 2.2 L 4WD 06/96-11/98;

INFINITI: G20 2.0 01/91-12/94, J30 3.0 01/92-12/97, PORSCHE 01/67-12/69





G15006

FEATURES / CARACTERÍSTICAS: 12V 5.0BAR 105L/H 7.8A

REPLACES / REEMPLAZA:

AC DELCO: EP217, EP225; **BOSCH**: 0580464044, 0580464027, 0 580 464 069, 9 580 233 008; KEM: EFP7334, EFP8146, EFP8175; OPEL: 90349944; PEUGEOT: 91538807; **PIERBURG**: 7.21565.70.0; CITROËN: 145070; RENAULT: 7700260678, 7700267774; **MD**: 76050; **ERA**: 770056; CITROËN/PEUGEOT: 1450 70, 91 518 190, 91 538 807; FIAT: 60546091, 60779188, 7597693; PORSCHE: 944 608 102 00, 944 608 102 03, 944 608 102 04, 944 608 102 06; SAAB: 93 92 911; VOLVO: 1306932, 285211.

APPLICATION / APLICACIÓN:

ALPIN: A610 3.0L 91-95, V6 2.5L 85-90;
CITROËN: CX II 2.5L 86-92;
PEUGEOT: CX II 2.5L 86-92, 505 2.8L 86-93, 505;
RENAULT: 21 SALOON 2.0L 90-92, 25(B29) 2.5L, 2.8L 84-92, ESPACE II 2.0L, 2.2L 91-96;
VOLGA: 3110 2, 3 01/95-;
PORSCHE: 02/83-12/91;
ABARTH RITMO;
ALFA ROMEO: 75;
FIAT: 132, ARGENTA, REGATA, RITMO, UNO;
PININFARINA: SPIDEREUROPA;
PORSCHE: 911, 924, 928, 944, 968;
SAAB: 900, 9000;
VOLVO: 340-360, 740, 760, 940.

G15007

FEATURES / CARACTERÍSTICAS: 12V 5.0BAR 105L/H 7.8A

REPLACES / REEMPLAZA:

AIRTEX: E10009, E8260; **BOSCH**: 0580 464 038; **BMW**: 16121115862, 16141 179231, 16141 118662; CITROËN: 145059, 145083, 145090, 152520, 54 71 660, 91 538 806, 91 539 329, 91 51404980, 91 538 806 80, DX 173 900 A; FIAT: 4429209, 4460210, 82308678, 82350177, 60546091; OPEL: 815003, 815004, 815005, 815011, 08 983 625, 90 020 443, 90 292 723, 90 349 944

APPLICATION / APLICACIÓN:

ALFA: 33(907A) 1.4L/1.5L/1.7L 90-94;
BMW: 2500 3.0L/3.2L 75-77;
CITROËN: BX(XB_) 1.4L/1.6L/1.9L 86-93;
FIAT: 124SPIDER 2.0L 82-85;
MG: MAESTRO 2.0L 84-90, METRO 1.3L 82-90, MONTEGO 2.0L 84-90;
OPEL: ASCONAB 2.0L/2.4L 79-81, COMMODOREC 2.5L 80-82;
PEUGEOT: 405I 1.9L 87-92;



G15007A

FEATURES / CARACTERÍSTICAS: 12V 5.0 BAR 95L/H

REPLACES / REEMPLAZA:

AIRTEX: E10009; **BOSCH**: 580254969; **BMW**: 16141179232; **GM**: 06443402, 52251 521; DAEWOO: 95957023

APPLICATION / APLICACIÓN:

FORD: CAPRI III (GCEP) 2.8 SUPER INJECTION 2.8L 01/81-04/87; **AUDI**: 200 2.1L 79>82; **MERCEDES**: 190 1.8L/ 2.0L/ 2.3L 82>93



G15007B

FEATURES / CARACTERÍSTICAS: 12V 5.0 BAR 95L/H

REPLACES / REEMPLAZA:

AC DELCO: EP181, EP186, EP224; **AIRTEX**: E7333, E8099, E10009; OPEL: 90232006, 90349994, 90323006, 90349994

APPLICATION / APLICACIÓN:

OPEL: SENATORB 2.5L/3.0L 87-93, ASCONAC 1.6L 86-88



G15007D

FEATURES / CARACTERÍSTICAS: 12V 5.0 BAR 100L/H

REPLACES / REEMPLAZA:

BOSCH: 0580464996, 0580464997; ALFA: 164100402100; FIAT/LANCIA: 5968085, 7580215, 60800164, 60805158

APPLICATION / APLICACIÓN:

ALFA ROMEO: 1642.0 TURBO 2L 01.88-09.92, GTV2.0V6 24V 2L 04/94



G15007F

FEATURES / CARACTERÍSTICAS: Diesel

REPLACES / REEMPLAZA:

BOSCH: 0 580 464 081; HYUNDAI: 31111-3J000; MEAT & DORIA: 76808

APPLICATION / APLICACIÓN:

HYUNDAI: ix55 3.0 V6 CRDi 4WD 2008>2012



GI5009

FEATURES / CARACTERÍSTICAS: 12V 5.0 BAR 95L/H

REPLACES / REEMPLAZA:

AC DELCO: EP447, EP448; AIRTEX: E10000, E10002

APPLICATION / APLICACIÓN:

ALFA: 75(162B) 1.8L 86-92;

FIAT: UNO(146A/E) 1.3L/1.4L 85-96;

PORSCHE: 911 3.2L 83-89;

RENAULT 21 SALOON 2.0L 90-92;

SAAB: 900I 2.0L 84-94;

VOLVO: 340-360 2.0L 82-89



GI5009B

FEATURES / CARACTERÍSTICAS: 12V 5.0 BAR 95L/H

REPLACES / REEMPLAZA:

BOSCH: 0580 464 084

APPLICATION / APLICACIÓN:

HYUNDAI: SANTAFE



GI5009D // NEW //

FEATURES / CARACTERÍSTICAS: Gasoline/ Diesel

REPLACES / REEMPLAZA:

BOSCH: 0 580 464 096, 0 580 464 075

APPLICATION / APLICACIÓN:

FORD: MONDEO III Saloon (B4Y) 2000>2007



GI5010

FEATURES / CARACTERÍSTICAS: 12V 3.0 BAR 100L/H

REPLACES / REEMPLAZA:

-

APPLICATION / APLICACIÓN:

SEAT: THEMA(834)2000IE



GI5014

FEATURES / CARACTERÍSTICAS: 12V 3.0 BAR 125L/H

REPLACES / REEMPLAZA:

AIRTEX: E8060, E8096; BOSCH: 0580464025, 0580254835, 0580464039, 0580464068; KEM: EFP8060; CITROËN: 145040, 145048, 7910028977, 791024676; JAGUAR: DBC 2482; PIERBURG: 7.21659.54, 7.21659.62, 7.21565.70.0, 7.21287.53.0; PORSCHE: 91160810200, 92860810200; RENAULT: 6001000470, 6001023051, 7711064162; SAAB: 8318859, 8334997, 9361015; VOLVO: 1306500, 1306831, 1336677, 1336679, 1389448, 1389449, 9142044, 9142045, 13068317, 1306932-3, 1336679-4, 1389449-8, 9142044-8, 9142045-5

APPLICATION / APLICACIÓN:

VOLVO: 240 2.3L 86-93, 740 2.0L/2.3L 85-92, 760 2.8L 86-91, 780 2.8L 86-90, 940 2.0L/2.3L 90-98, 960 2.9L 90-96;

JAGUAR: 4.0L 88-92



GI5015

FEATURES / CARACTERÍSTICAS: 12V 5.0 BAR 95L/H

REPLACES / REEMPLAZA:

DELPHI: FE8232, FE8064; AIRTEX: E8376

APPLICATION / APLICACIÓN:

NISSAN: BLUE BIRD MAXIMA PULSAR 1.8L /3.0L 86-91



GI5017

FEATURES / CARACTERÍSTICAS: 12V 5.0 BAR 95L/H

REPLACES / REEMPLAZA:

P37

APPLICATION / APLICACIÓN:

FORD;

LINCOLN: CONTINENTAL 1983-1984 V8-302 5.0L



GI6002

FEATURES / CARACTERÍSTICAS: 12V 6.0BAR 100L/H 10A

REPLACES / REEMPLAZA:

AIRTEX: E10008, E8149; **BOSCH:** 0 580 254 910, 0 580 464 039, 0580 254 910, 0580 254 922, 0580 254 943, 0580 254 973, 0580 254 974; **FORD:** 1613157, 6106539, 82GB9350AA, 83BB9350AA; **MERCEDES:** 1160910301; **PIEBURG:** 7.21659.72.0; **VW:** 893906091B, 893906091E

APPLICATION / APLICACIÓN:

FORD: CAPRI III (GEC) 2.8 SUPER INJECTION 2.8L 01/81-04/87, ESCORT III(GAA)1.6(GAA) 1.6L 07/85-12/85, ESCORT III(GAA)1.6RS TURBO 1.6L 11/84-12/85, ESCORT III(GAA)1.6XR31 1.6L 10/82-12/85, ESCORT III(GAA)RS16001 1.6L 05/82-12/85, ESCORT III CONVERTIBLE(ALD)1.6L 09/83-12/85, ESCORT IV (GAF, AWF, ABFT)1.6 1.6L 01/86-08/89, ESCORT IV(GAF, AWF, ABFT)1.6 1.6L 01/86-07/90, ESCORT IV CONVERTIBLE(ALF)1.6 1.6L 01/86-07/90, GRANADA(GU)2.8I 2.8L 08/77-08/85, GRANADA(GU)2.8I 2.8L 10/82-01/85, GRANADA(GU)2.8I 2.8L 10/82-08/85, GRANADA ESTATE(GUN)2.8I 2.8L 08/77-08/85, GRANADA ESTATE(GUN)2.8I 2.8L 10/82-01/86, GRANADA ESTATE(GUN)2.8I 2.8L 10/82-08/86, MONDIAL8 QUATTROVALVILE 2.8L 10/82-07/87, ORION I(AFD)1.6I 1.6L 07/83-03/86, ORION II(AFF)1.6I 1.6L 03/86-07/90, SERRA ESTATE(GBC)2.8 XR4I 2.8L 08/82-12/86, SERRA HATCHBACK(GBC)2.8IXR 2.8L 09/83-12/86, SERRA HATCHBACK(GBC)2.8XR4I 2.8L 08/82-12/86, SIERRA ESTATE 2.8L 82-86, SIERRA HATCHBACK(GBC) 2.8L 82-86;

AUDI: 200 2.1L 79-82, 80 1.8L/2.0L 86-91, 90 2.0L/2.2L/2.3L 87-91, CABRIOLET 2.0L/2.3L/2.6L/2.8L 91-00, QUATTRO 2.2L 89-91;

MERCEDES: 190 1.8L/2.0L/2.3L 82-93, COUPE 2.2L/2.3L/2.7L 77-92, E-CLASS 2.0L/2.2L/3.0L 93-98, G-CLASS 2.3L/2.7L 79-92, KOMBI ESTATE 2.3L/2.7L 77-85, S-CLASS 2.6L/2.7L/3.0L/3.8L/5.0L 79-91, SL(R107) 2.7L/3.0L/3.5L/3.8L/4.5L 71-89, SL COUPE(C107) 2.7L/3.5L/3.8L/4.5L 74-81, SALOON 2.0L/2.3L/2.6L/2.7L/3.0L 76-93

GI6002A

FEATURES / CARACTERÍSTICAS: 12V 6.0 BAR 100L/H

REPLACES / REEMPLAZA:

AIRTEX: E10001, E10004, E8150, E8169, E8169, E8171; **BOSCH:** 0580 254 957, 0580 254 961, 0580 254 964, 0580 254 980, 0580 254 981; **BMW:** 2204346, 1612.1.150.201; **PEUGEOT:** 145040, 145048, 145054, 7910028977, 7910246476, 7919028977, 7919029977, 9 15 0730 880, 9 151379 480; **PIEBURG:** 9150730880, 9151379480, 7.21659.70.0; **VW:** 431 906091, 171906091A, 477906091C; **VOLVO:** 13069323

APPLICATION / APLICACIÓN:

BMW: 3 1.8L/2.0L/2.3L 79-87, 5 1.8L/2.0L 79-87;

PEUGEOT: 505(551A) 2.0L/2.2L 79-86;

VW: CADDY 1.8L 85-92, GOLF I 1.6L/1.8L 76-93, JETTA I 1.6L/1.8L 79-83, PASSAT VARIANT 1.6L 78-80, SCIROCCO(53B) 1.6L/1.8L 80-92;

AUDI: 100 2.1L 77-82, QUATTRO(85) 2.1L 80-87;

PORSCHE: 911 3.0L/3.3L 77-87, 924 2.0L 75-89, 928 4.7L 79-83;

VOLVO: 240 2.1L/2.3L 80-89, 760 2.8L 81-88

GI6002B

FEATURES / CARACTERÍSTICAS: 12V 6.0 BAR 100L/H

REPLACES / REEMPLAZA:

AC DELCO: EP218, EP407; **AIRTEX:** E8309, E8348; **BOSCH:** 0 580 254 019, 0 580 254 020, 0 580 254 023, 0 580 254 024, 0 580 254 025, 0 580 254 026, 0 580 254 031, 0 580 254 032, 0 580 254 034, 0 580 254 035, 0 580 254 036, 0 580 254 037, 0 580 254 038, 0 580 254 039, 0 580 254 040, 0 580 254 041, 0 580 254 042, 0 580 254 043, 0 580 464 988, 0 580 464 989, 0580 254 019, 0580 254 031, 0580 254 036, 0580 254 040, 0580 254 921, 0580 254 928, 0580 254 956, 0580 254 988, 0580 254 991; **KEM:** EFP8194, EFP8309, EFP8348; **VW:** 0 580 254 003, 0 580 254 004, 0 580 254 005, 0 580 254 006, 0 580 254 014, 0 580 254 015, 0 580 254 016, 0 580 254 017, 895 906091, 441906091A, 441906091B, 443906087BE, 443 906091D, 443 906091E, 447 906091A, 895906089E, 895906091A

APPLICATION / APLICACIÓN:

FORD: CAPRI III 2.8L 81-87, ESCORT III 1.6L 80-85;

AMERICAN MOTORS: 100QUATTRO 2.3L 1991, 200 QUATTRO TURBO SEDAN 2.3L 1991;

AUDI: 100 2.1L 03/77>84, CABRIOLET 2.0L/2.3L/2.6L/2.8L 91>00

MERCEDES-BENZ: 190 1.8L/2.0L/2.3L 92-93, COUPE 2.2L/2.3L/2.7L/3.0L 77-93

GI6003

FEATURES / CARACTERÍSTICAS: 12V 6.0 BAR 100L/H

REPLACES / REEMPLAZA:

AC DELCO: EP428; **AIRTEX:** E10003, E10004, E10008, E8146; **BOSCH:** 0 580 254 050, 0 580 254 909, 0 580 254 921, 0 580 254 927, 0 580 254 932, 0 580 254 954, 0 580 254 956, 0 580 254 958, 0 580 254 960, 0 580 254 962, 0 580 254 963, 0 580 254 965, 0 580 254 970, 0 580 254 971, 0 580 254 974, 0 580 254 980, 0 580 254 992, 0 580 254 910, 0 580 254 914, 0 580 254 915, 0 580 464 034, 0 580 464 040, 0 580 254 909, 0 580 254 927, 0 580 254 931, 0 580 254 932, 0 580 254 934, 0 580 254 949, 0 580 254 958, 0 580 254 959, 0580 254 960, 0 580 254 965, 0 580 254 966, 0 580 254 970, 0 580 254 971; **DELPHI:** FE0147, **KEM:** EFP8146, EFP8175; **PIEBURG:** 7.21565.51.0, 7.21659.50, 7.21659.70.0; **CHRYSLER:** MD069189, MD074182, MD074602; **CITROËN:** 145054, 9150730880, 9151379480; **PORSCHE:** 91160810202, 92809460801; **RENAULT:** 7700266206, 9999163575431 906091, 893906091; **VW:** 893 906091, 431906091B, 431906091C, 431906091D, 443906091A, 477906091B, 810906091 B, 810906091C, 893 906 091 B, 893 906 091 D; **VOLVO:** 1266006, 1306028, 1336517, 1389447, 1389477, 13365176

APPLICATION / APLICACIÓN:

AUDI: 100 2.1L 77-84, 200 2.2L 88-90, 80 1.6L/1.8L/2.0L/2.1L 79-91, 90 2.0L/2.2L/2.3L 84-91, CABRIOLET 2.0L/2.3L/2.6L/2.8L 91-00, COUPE 1.6L/1.8L/2.0L/2.1L/2.2L/2.3L 80-96, QUATTRO 2.2L 87-89;

VW: 1.8L 87;

MERCEDES-BENZ: 95-20

GI6005

FEATURES / CARACTERÍSTICAS: 12V 6.0 BAR 100L/H

REPLACES / REEMPLAZA:

VW: 191906091C, 191906091H, 191906091J; **BOSCH:** 0 580 254 021, 0 580 254 033, 0 580 254 013, 0 580 254 008

APPLICATION / APLICACIÓN:

VW: GOLF II .8L 83-91;

SEAT: TOLEDO 1.8L 91-99





EMS COMPONENTS | SISTEMA DE CONTROL DE MOTOR

STRAINERS AND TYPICAL KITS | FILTROS Y KITS TÍPICOS

<p>GF001</p>  <p>SIZE: 140 X 44mm DIAMETER: Φ 19 +0.1mm</p>	<p>GF002</p>  <p>SIZE: 140 X 44mm DIAMETER: Φ 19 +0.1mm</p>	<p>GF003</p>  <p>SIZE: 119 X 48mm DIAMETER: Φ 19 +0.1mm</p>	<p>GF004</p>  <p>SIZE: 136 X 45mm DIAMETER: Φ 22.3 ±0.05mm</p>
<p>GF005</p>  <p>SIZE: 126 X 41.5mm DIAMETER: Φ 21 +0.01mm</p>	<p>GF007</p>  <p>SIZE: 147 X 48.5mm DIAMETER: Φ 13.8 ±0.1mm</p>	<p>GF008</p>  <p>SIZE: 136 X 45mm DIAMETER: Φ 22.3 ±0.05mm</p>	<p>GF009</p>  <p>SIZE: 110 X 56mm DIAMETER: Φ 19 +0.1mm</p>
<p>GF010</p>  <p>SIZE: 99 X 54mm DIAMETER: Φ 11 +0.1mm</p>	<p>GF011</p>  <p>SIZE: 84 X 41mm DIAMETER: Φ 9.5 ±0.1mm</p>	<p>GF012</p>  <p>SIZE: 84.8 X 62.2mm DIAMETER: Φ 11 -0.1mm</p>	<p>GF013</p>  <p>SIZE: 84 X 52.5mm DIAMETER: Φ 19.5 ±0.1mm</p>
<p>GF014</p>  <p>SIZE: 75.5 X 59.5mm DIAMETER: Φ 9.5 -0.1mm; Φ 5.5 ±0.05mm</p>	<p>GF015</p>  <p>SIZE: Φ 77mm DIAMETER: Φ 19 ±0.1mm</p>	<p>GF016</p>  <p>SIZE: 77 X 60.5mm DIAMETER: Φ 11-0.15mm</p>	<p>GF017</p>  <p>SIZE: 55.8 X 59mm DIAMETER: Φ 11 ±0.1mm</p>
<p>GF018</p>  <p>SIZE: 166 X 44.5mm DIAMETER: Φ 10.9 ±0.05mm</p>	<p>GF019</p>  <p>SIZE: 88.5 X 65mm DIAMETER: Φ 14mm</p>	<p>GF020</p>  <p>SIZE: 100 X 60mm DIAMETER: Φ 22 ±0.1mm</p>	<p>GF021</p>  <p>SIZE: 135.8 X 55mm DIAMETER: Φ 22 ±0.1mm</p>
<p>GF021A</p>  <p>SIZE: 135.8 X 55mm DIAMETER: Φ 22 ±0.1mm</p>	<p>GF022</p>  <p>SIZE: 103 X 50mm DIAMETER: Φ 22 ±0.1mm</p>	<p>GF023</p>  <p>SIZE: 131 X 56.5mm DIAMETER: Φ 22 ±0.15mm</p>	<p>GF024</p>  <p>SIZE: 97 X 40mm DIAMETER: Φ 11 ±0.05mm</p>
<p>GF025</p>  <p>SIZE: 188 X 38mm DIAMETER: Φ 19 +0.1mm</p>	<p>GF026</p>  <p>SIZE: 147 X 36.5mm DIAMETER: Φ 19 +0.1mm</p>	<p>GF027</p>  <p>SIZE: 166 X 44.5mm DIAMETER: Φ 10.9 ±0.05mm</p>	<p>GF028</p>  <p>SIZE: 113.5 X 35mm DIAMETER: Φ 19 ±0.1mm</p>

<p>GF029</p> <p>SIZE: 156 X 46mm DIAMETER: Φ 11 -0.1mm</p> 	<p>GF030</p> <p>SIZE: 156 X 46mm DIAMETER: Φ 11 -0.1mm</p> 	<p>GF031</p> <p>SIZE: 132.5 X 52mm DIAMETER: Φ 11 -0.1mm</p> 	<p>GF032</p> <p>SIZE: 145.5 X 33mm DIAMETER: Φ 22.3 ±0.05mm</p> 
<p>GF033</p> <p>SIZE: 151 X 35mm DIAMETER: Φ 19 +0.1mm</p> 	<p>GF034</p> <p>SIZE: 168 X 40.5mm DIAMETER: Φ 12 -0.1mm</p> 	<p>GF036</p> <p>SIZE: 53.4 X 53.8mm DIAMETER: ---</p> 	<p>GF037</p> <p>SIZE: 84 X 64mm DIAMETER: Φ 11 -0.1mm</p> 
<p>GF038</p> <p>SIZE: 84 X 64mm DIAMETER: Φ 11 -0.1mm</p> 	<p>GF040</p> <p>SIZE: Φ 79mm DIAMETER: Φ 10.8 ±0.15mm</p> 	<p>GF041</p> <p>SIZE: Φ 79mm DIAMETER: Φ 10.8 ±0.15mm</p> 	<p>GF042</p> <p>SIZE: 88 X 63mm DIAMETER: Φ 22.2 ±0.14mm</p> 
<p>GF043</p> <p>SIZE: 83.5 X 60.5mm DIAMETER: Φ 27.1 +0.1-0.3mm</p> 	<p>GF044</p> <p>SIZE: 87.5 X 77mm DIAMETER: Φ 25.3 ±0.15mm</p> 	<p>GF045</p> <p>SIZE: 75 X 50.5mm DIAMETER: Φ 11 -0.1mm</p> 	<p>GF046</p> <p>SIZE: 63.5 X 62.5mm DIAMETER: Φ 11.1 ±0.1mm</p> 
<p>GF047</p> <p>SIZE: 95 X 56.5mm DIAMETER: Φ 11 ±0.05mm</p> 	<p>GF048</p> <p>SIZE: 95 X 56.5mm DIAMETER: Φ 11 +0.1mm</p> 	<p>GF048A</p> <p>SIZE: 60.7 X 53.2mm DIAMETER: Φ 11 +0.1mm</p> 	<p>GF048B</p> <p>SIZE: 54 X 22mm DIAMETER: Φ 11mm</p> 
<p>GF049</p> <p>SIZE: 95 X 56.5mm DIAMETER: Φ 11mm</p> 	<p>GF050</p> <p>SIZE: 55 X 56.5mm DIAMETER: Φ 22 ±0.1mm</p> 	<p>GF051</p> <p>SIZE: 135.8 X 55mm DIAMETER: Φ 22 ±0.1mm</p> 	<p>GF052</p> <p>SIZE: 63.5 X 62.5mm DIAMETER: Φ 11.1 ±0.1mm</p> 
<p>GF053</p> <p>SIZE: 55 X 42mm DIAMETER: Φ 14.7x9.4mm</p> 	<p>GF054</p> <p>SIZE: 26.8X 29.6mm DIAMETER: Φ 24 ±0.1mm</p> 	<p>GF055</p> <p>SIZE: 17.5 X 13.3mm DIAMETER: Φ 16mm</p> 	<p>GF056</p> <p>SIZE: 27.5 X 15mm DIAMETER: Φ 26 ±0.1mm</p> 

GF060 SIZE: 89.5 X 64mm DIAMETER: Φ 11-0.1mm	GF061 SIZE: 92.5 X 55.5mm DIAMETER: Φ 11-0.1mm	GF062 SIZE: 84 X 61.5mm DIAMETER: Φ 11-0.1mm	GF063 SIZE: 57 X 30.5mm DIAMETER: Φ 11-0.1mm
GF064 SIZE: 110 X 59mm DIAMETER: Φ 12 -0.1mm	GF065 SIZE: 101.5 X 65mm DIAMETER: Φ 11-0.1mm	GF066 SIZE: 75 X 65.5mm DIAMETER: Φ 13.5±0.05mm	GF067 SIZE: 92 X 67.5mm DIAMETER: Φ 11.5±0.1mm
GF068A SIZE: 92 X 67.5mm DIAMETER: Φ 12±0.1mm	GF068B SIZE: 101.5 X 65mm DIAMETER: Φ 11-0.1mm	GF068C SIZE: 101.5 X 65mm DIAMETER: Φ 11-0.1mm	GF069 SIZE: 131.5 X 48mm DIAMETER: Φ 11±0.1mm
GF070 SIZE: 75x65.5mm DIAMETER: Φ 13.5±0.05mm	GF073 SIZE: 145 X 53.5mm DIAMETER: Φ 11±0.05mm	GF074 SIZE: 106 X 44mm DIAMETER: Φ 11±0.05mm	GF075 SIZE: 75 X 65.5mm DIAMETER: Φ 22±0.15mm
GF076 SIZE: 111 X 56mm DIAMETER: Φ 11mm	GF078 SIZE: 84.5 X 69.5mm DIAMETER: Φ 19.5±0.15mm	GF081 SIZE: 77.8 X 36.2mm DIAMETER: Φ 10.9±0.05mm	GF082 SIZE: 107.8 X 41.4mm DIAMETER: Φ 19±0.1mm
GF084 SIZE: 108 X 60mm DIAMETER: Φ 11±0.1mm	GF087 SIZE: 145 X 60mm DIAMETER: Φ 11 ±0.1mm	GF088 SIZE: 70 X 22.5mm DIAMETER: Φ 11±0.1mm	GF090 SIZE: 73 X 61mm DIAMETER: Φ 11±0.1mm
GF091 SIZE: 107.8 X 41.4mm DIAMETER: Φ 11±0.1mm	GF092 SIZE: Φ 77mm DIAMETER: Φ 2.7±0.1mm	GF093 SIZE: 113.5 X 58mm DIAMETER: Φ 11±0.1mm	GF094 SIZE: 130 X 52mm DIAMETER: Φ 19.5±0.1mm

GF095  SIZE: 85 X 63mm DIAMETER: Φ 11±0.1mm	GF096  SIZE: 190 X 55mm DIAMETER: Φ 22±0.15mm	GF097  SIZE: 150 X 56mm DIAMETER: Φ 14±0.1mm	GF099  SIZE: 157 X 60mm DIAMETER: Φ 19±0.1mm
GF100  SIZE: 110 X 50mm DIAMETER: Φ 11±0.1mm	GF101  SIZE: 120 X 62mm DIAMETER: Φ 11±0.1mm	GF103  SIZE: 92 X 72mm DIAMETER: Φ 11mm	GF104  SIZE: 73.8 X 65.8mm DIAMETER: Φ 11.7mm
GF105  SIZE: 132 X 55mm DIAMETER: Φ 10.8±0.05mm	GF106  SIZE: 132 X 65mm DIAMETER: Φ 22±0.05mm	GF107  SIZE: 82 X 58mm DIAMETER: Φ 22±0.05mm	GF108  SIZE: 90 X 85mm DIAMETER: Φ 11±0.1mm
GF109  SIZE: 83.5 X 79mm DIAMETER: Φ 22±0.05mm	GF110  SIZE: 150 X 56mm DIAMETER: Φ 27±0.1mm	GF111  SIZE: 512mm DIAMETER: Φ 22±0.05mm	GF112  SIZE: 85.5 X 81mm DIAMETER: Φ 11±0.1mm
GF113  SIZE: 93 X 88mm DIAMETER: Φ 22.6±0.1mm	GF117  SIZE: 43 X 43mm DIAMETER: ---	GF119  SIZE: 77.5 X 57.5mm DIAMETER: Φ 10.8±0.1mm	GF120  SIZE: 80.5 X 77mm DIAMETER: Φ 19±0.15mm
GF121  SIZE: 83 X 62mm DIAMETER: Φ 11±0.1mm	GF122  SIZE: 68.5 X 12.5mm DIAMETER: ---	GF124  SIZE: 90 X 68mm DIAMETER: Φ 11±0.1mm	GF125  SIZE: 78 X 63mm DIAMETER: Φ 12±0.1mm
GF126  SIZE: 158 X 66mm DIAMETER: Φ 11±0.1mm	GF127  SIZE: 131 X 61mm DIAMETER: Φ 11±0.1mm	GF128  SIZE: 137.5 X 59mm DIAMETER: Φ 11±0.1mm	GF129  SIZE: 149.5 X 73.5mm DIAMETER: Φ 11±0.1mm

GF130  SIZE: 99 X 55mm DIAMETER: Φ 11.2±0.1mm	GF132  SIZE: 112 X 55mm DIAMETER: Φ 11±0.1mm	GF133  SIZE: 95 X 70mm DIAMETER: Φ 11±0.1mm	GF134  SIZE: 30.5 X 1.9mm DIAMETER: ---
GF135  SIZE: 51.55 X 16.5mm DIAMETER: Φ 19±0.1mm	GF136  SIZE: 87.2±0.3mm DIAMETER: Φ 5.5±0.05mm	GF138  SIZE: 134.5 X 60mm DIAMETER: Φ 11±0.1mm	GF140  SIZE: 99 X 92mm DIAMETER: Φ 11±0.1mm
GF141  SIZE: 140 X 45mm DIAMETER: Φ 20mm	GF142  SIZE: Φ 40mm DIAMETER: Φ 12±0.1mm	GF143  SIZE: Φ 85 X 48mm DIAMETER: Φ 11±0.1mm	GF145  SIZE: 131.5 X 61.5mm DIAMETER: Φ 11±0.1mm
GF146  SIZE: 106.5 X 89.5mm DIAMETER: Φ 11±0.1mm	GF147  SIZE: 102 X 51mm DIAMETER: Φ 22±0.1mm	GF148  SIZE: 80 X 52mm DIAMETER: Φ 11±0.15mm	GF149  SIZE: 60 X 58mm DIAMETER: Φ 11±0.1mm
GF150  SIZE: 102 X 67mm DIAMETER: Φ 11±0.1mm	GF151  SIZE: 88.5 X 58.5mm DIAMETER: Φ 11±0.1mm	GF152  SIZE: 86 X 53mm DIAMETER: Φ 11±0.1mm	GF153  SIZE: 127 X 68.5mm±2mm DIAMETER: Φ 11±0.15mm
GF154  SIZE: --- DIAMETER: Φ 11±0.1mm	GF156  SIZE: 47.4 X 58.4mm±2mm DIAMETER: Φ 9.8±0.05mm	GF157  SIZE: 155 X 70mm±2mm DIAMETER: Φ 11-0.1mm	GF158  SIZE: 105 X 80mm±2mm DIAMETER: Φ 11-0.1mm
GF159  SIZE: 76.5 X 76.5mm±2mm DIAMETER: Φ 19.3±0.1mm, Φ 11±0.1mm	GF160  SIZE: 107 X 105mm±2mm DIAMETER: Φ 11±0.1mm	GF162  SIZE: --- DIAMETER: Φ 11±0.1mm	GF170A  SIZE: 90 x 54mm DIAMETER: Φ 19±0.1mm

<p>GF175</p>  <p>SIZE: --- DIAMETER: Φ 8.8-0.1mm</p>	<p>GF176</p>  <p>SIZE: --- DIAMETER: ---</p>	<p>GF177</p>  <p>SIZE: 47 x 48mm DIAMETER: Φ 13.8±0.05mm</p>	<p>GF178</p>  <p>SIZE: 56 x 42mm DIAMETER: Φ 12.4±0.1mm</p>
<p>GF181</p>  <p>SIZE: 135 x 55mm DIAMETER: 21.3 ± 0.2mm</p>	<p>GF183</p>  <p>SIZE: 135 x 55mm DIAMETER: 21.3 ± 0.2mm</p>	<p>GF185</p>  <p>SIZE: 195 x 60 ±2mm DIAMETER: 11 ± 0.1mm</p>	<p>GF186</p>  <p>SIZE: 110 x 65mm DIAMETER: 11-0.1mm</p>
<p>GF187</p>  <p>SIZE: 150 x 60mm DIAMETER: 11-0.1mm</p>	<p>GF189</p>  <p>SIZE: 85 x 82mm DIAMETER: 25.5+0.1mm</p>	<p>GF196</p>  <p>SIZE: 78 x 70mm DIAMETER: Φ 19-0.2mm</p>	<p>GF197</p>  <p>SIZE: 52 x 42mm DIAMETER: 11-0.1mm</p>

<p>GK2001</p>  <p>FOR: GI3601</p>	<p>GK2002</p>  <p>FOR: GI3601</p>	<p>GK2003</p>  <p>FOR: GI3602</p>	<p>GK2004</p>  <p>FOR: GI3602</p>
<p>GK2005</p>  <p>FOR: GI3602</p>	<p>GK2006</p>  <p>FOR: GI3601</p>	<p>GK2007</p>  <p>FOR: GI3605</p>	<p>GK2008</p>  <p>FOR: GI3605</p>
<p>GK2009</p>  <p>FOR: GI3607</p>	<p>GK2010</p>  <p>FOR: GI3607</p>	<p>GK2011</p>  <p>FOR: GI3607A</p>	<p>GK2012</p>  <p>FOR: GI3607B</p>
<p>GK2013</p>  <p>FOR: GI3607B</p>	<p>GK2014</p>  <p>FOR: GI3607B</p>	<p>GK2015</p>  <p>FOR: GI3608</p>	<p>GK2016</p>  <p>FOR: GI3608</p>
<p>GK2017</p>  <p>FOR: GI3608</p>	<p>GK2018</p>  <p>FOR: GI3608A</p>	<p>GK2019</p>  <p>FOR: GI3608B</p>	<p>GK2020</p>  <p>FOR: GI3610</p>
<p>GK3001</p>  <p>FOR: GI3801</p>	<p>GK3002</p>  <p>FOR: GI3802</p>	<p>GK3003</p>  <p>FOR: GI3802</p>	<p>GK3004</p>  <p>FOR: GI3802</p>
<p>GK3005</p>  <p>FOR: GI3603</p>	<p>GK3007</p>  <p>FOR: GI3803</p>	<p>GK3008</p>  <p>FOR: GI3807</p>	<p>GK3009</p>  <p>FOR: GI3807</p>

<p>GK3010</p>  <p>FOR: GI3607</p>	<p>GK3011</p>  <p>FOR: GI3807</p>	<p>GK3012</p>  <p>FOR: GI3808</p>	<p>GK3014</p>  <p>FOR: GI3810</p>
<p>GK3015</p>  <p>FOR: GI3814</p>	<p>GK3017</p>  <p>FOR: GI3818</p>	<p>GK3018</p>  <p>FOR: GI3827</p>	<p>GK3019 // NEW //</p>  <p>FOR: GI3120 GI3121</p>
<p>GK3020 // NEW //</p>  <p>FOR: GI3103</p>	<p>GK3021 // NEW //</p>  <p>FOR:</p>	<p>GK5001</p>  <p>FOR: GI5001</p>	<p>GK5002</p>  <p>FOR: GI5001</p>
<p>GK5003</p>  <p>FOR: GI5001</p>	<p>GK5004</p>  <p>FOR: GI5001A</p>	<p>GK5005</p>  <p>FOR: GI5001B</p>	<p>GK5006 // NEW //</p>  <p>FOR: GI5001KT</p>



EMS COMPONENTS | SISTEMA DE CONTROL DE MOTOR
MODULE (ASSEMBLIES) | MÓDULOS (MONTAJES)



GCA01

FEATURES / CARACTERÍSTICAS: 12V 3.5 BAR 120 L/H

REPLACES / REEMPLAZA:

AIRTEX: E8234M; **BOSCH:** 0580453019, 0580453021, 0580453040, 0580464995; **BMW:** 16141178839, 16141179119, 16141179992, 16141181294, 16141181354, 16141181862, 16141181864, 16141183009, 16144138604, 16141180318, 16141178119, 16147161387; **PIEBURG:** 72191300, 72191350; **BOSCH:** 0 580 314 123

APPLICATION / APLICACIÓN:

BMW: 518 I 1.8L 08.89-09.95, 520 I 2.0L 01.88-08.91, 520 I 2.0L 09.89-09.95, 525 I 2.5L 01.88-08.91, 525 I 2.5L 09.89-09.95, 525 I 2.5I 10.91-09.95, 530 I 3.0L 01.88-08.96, 535 I 3.4L 01.99-09.95, M5 3.6L 10.88-05.92, SERIES 5 E32735, SERIES 7 E34518



GCA01B

FEATURES / CARACTERÍSTICAS: 12V 3.0BAR 100L/H

REPLACES / REEMPLAZA:

BMW: 16141178119, 16141179119, 16141180318, 16147161387

APPLICATION / APLICACIÓN:

BMW: 518 I 1.8L 08.89-09.95, 520 I 2.0L 01.88-08.91, 520 I 2.0L 09.89-09.95, 525 I 2.5L 01.88-08.91, 525 I 2.5L 09.89-09.95, 525 I 2.5I 10.91-09.95, 530 I 3.0L 01.88-08.96, 535 I 3.4L 01.99-09.95, M5 3.6L 10.88-05.92



GCA07B

FEATURES / CARACTERÍSTICAS: 12V 1.2BAR 100L/H

REPLACES / REEMPLAZA:

BOSCH: F00OTE0112; **VW:** 1H0906091D, 1H0919051AJ, 1H0919051C, 1H0919051CQ, 1H0919651H, 1H0919651N, 1H0919051E, 1HM919051F, 1L0919051D, 3A5919051P, 6N0919051E, 6N0919051J; **FORD:** 1028808, 95VW 9H307 AC, 96VW 9H307 AA

APPLICATION / APLICACIÓN:

FORD: GALAX 2.0/2.3/2.8L 11.95-05.98, SEAT: ALHAMBRA 1.8L/2.0L 04.96-05.98, CORDO 1.4/1.6/1.8/2.0L 02.93-06.98, IBIZA II 1.4L 09.96-08.99; **VW:** GOLF III 1.4L/1.6L/2.0L 10.91-08.97, PASSAT I 1.6L/2.0L 10.94-08.96, POLO II 1.0L/1.4L/1.6L 10.96-10.99, SHARAN 1.8L/2.0/2.8L 09.97-05.98, TRANSPORTER IV 2.0L/2.5L/2.8L 09.90+, VENTO 1.4L/1.6L/2.0L/2.8L 11.91-09.98



GCA08B

FEATURES / CARACTERÍSTICAS: 12V 3.0BAR 100L/H

REPLACES / REEMPLAZA:

FORD: 1028808, 95VW 9H307 AC, 96VW 9H307 AA; **VW:** 1H0919651K, 1H0919651P, 1L0919051E, 6K9919051D, 6N0919051K, 7M0919051B, 7M0919051C, 7M0919051D, 1H0 919 051 AK, 1H0 919 051 L, 1H0 919 651 K, 1H0 919 651 P, 1L0 919 051 E, 6K9 919 051 D, 6N0 919 051 K, 7M0 919 051 B, 7M0 919 051 C, 7M0 919 051 D

APPLICATION / APLICACIÓN:

FORD: GALAXY (WGR) 2.0 L 11/95-05/98, GALAXY (WGR), 2.8 L V6 11/95-05/98, GALAXY (WGR) 2.8 L V6 4X4 04/96-05/98, GALAXY (WGR) 2.3 16V 01/97-05/98, SEAT CORDOBA (6K2/C2) 1.4 L 06/94-06/99, CORDOBA (6K2/C2) 1.6 L 02/93-06/99, CORDOBA (6K2/C2) 2.0 L 02/93- 6/99, CORDOBA (6K2/C2) 1.8 L 16V 10/93-08/96, CORDOBA (6K2/C2) 2.0 L 16V 08/96-06/99, IBIZA II (6K1) 1.4 L 16V 09/96-08/99, INCA (6K9) 1.4 L 11/95->, INCA (6K9) 1.4 16V 04/00->, ALHAMBRA (7V8, 7V9) 2.0 L (->T F7MW070000) 04/96-05/98, ALHAMBRA (7V8, 7V9) 1.8 T 20V (->T F7MW070000) 10/97-05/98, CORDOBA VARIO (6K5) 1.4 L 09/96-06/99, CORDOBA VARIO (6K5) 1.6 L 09/96-06/99, CORDOBA VARIO (6K5) 1.6 L 09/96-06/99; **VOLKSWAGEN:** PASSAT (3A2, 35I) 2.0 10/93-08/96, PASSAT (3A2, 35I) 2.0 16V 01/94-08/96, PASSAT (3A2, 35I) 1.6 10/94-08/96, PASSAT (3A2, 35I) 2.0 SYNCRO 10/90-08/96, PASSAT VARIANT (3A5, 35I) 2.0 10/93-05/97, PASSAT VARIANT (3A5, 35I) 2.0 16V 01/94-05/97, PASSAT VARIANT (3A5, 35I) 1.6 07/94-12/95, POLO (6N1) 75 1.6 10/94-10/99, POLO (6N1) 100 1.4 16V 04/96-10/99, POLO (6N1) 50 1.0 09/96-10/99, TRANSPORTER IV AUTOBUS (70XB, 70XC, 7DB, 7DW) 2.5 SYNCRO 11/92-04/03, TRANSPORTER IV AUTOBUS (70XB, 70XC, 7DB, 7DW) 2.5 SYNCRO 07/96-04/03, TRANSPORTER IV AUTOBUS (70XB, 70XC, 7DB, 7DW) 2.5 08/96-04/03, TRANSPORTER IV AUTOBUS (70XB, 70XC, 7DB, 7DW) 2.8 VR 6 11/95-04/00, GOLF III CABRIOLET (1E7) 2.0 07/93-05/98, GOLF III CABRIOLET (1E7) 1.6 10/94-05/98, GOLF III (1H1) 1.6 09/92-08/97, GOLF III (1H1) 2.0 11/91-08/97, GOLF III (1H1) 2.0 GTL 16V 08/92-08/97, GOLF III (1H1) 1.4 10/91-08/97, GOLF III (1H1) 2.8 VR6 01/92-08/97, GOLF III VARIANT (1H5) 1.4 07/93-04/99, GOLF III VARIANT (1H5) 2.0 07/93-04/99, GOLF III VARIANT (1H5) 1.6 07/94-04/99, SHARAN (7M8, 7M9, 7M6) 2.0 (->T F7MW070000) 09/95-05/98, SHARAN (7M8, 7M9, 7M6) 2.8 VR6 (->T F7MW070000) 09/95-05/98, SHARAN (7M8, 7M9, 7M6) 2.8 VR6 SYNCRO (->T F7MW070000) 11/96-05/98, SHARAN (7M8, 7M9, 7M6) 1.8 T 20V (->T F7MW070000) 09/97-05/98, POLO CLASSIC (6KV2) 60 1.4 12/95-09/01, POLO CLASSIC (6KV2) 100 1.6 12/95-09/01, TRANSPORTER IV FURGON (70XA) 2.0 10/92-04/03, TRANSPORTER IV FURGON (70XA) 2.5 10/92-04/03, TRANSPORTER IV FURGON (70XA) 2.5 SYNCRO 10/92-04/03, TRANSPORTER IV FURGON (70XA) 2.5 SYNCRO 08/96-04/03, TRANSPORTER IV CAJA/CHASIS (70XD) 2.5 10/92-04/03, TRANSPORTER IV CAJA/CHASIS (70XD) 2.5 SYNCRO 10/92-04/03, TRANSPORTER IV CAJA/CHASIS (70XD) 2.0 10/92-04/03, TRANSPORTER IV CAJA/CHASIS (70XD) 2.5 08/96-04/03, TRANSPORTER IV CAJA/CHASIS (70XD) 2.5 SYNCRO 08/96-04/03, GOLF IV CABRIOLET (1E7) 1.6 06/98-06/02, GOLF IV CABRIOLET (1E7) 2.0 06/98-06/02, VENTO (1H2) 1.4 11/91-09/98, VENTO (1H2) 1.6 09/92-09/98, VENTO (1H2) 2.0 11/91-09/98, VENTO (1H2) 2.8 VR6 01/92-09/98, VENTO (1H2) 1.6 10/94-09/98, CORRADO (53I) 2.0 L 16V 10/94-12/95, CORRADO (53I) 2.0 L 10/94-



GCA09

FEATURES / CARACTERÍSTICAS: 12V 3.0BAR 100L/H

REPLACES / REEMPLAZA:

BOSCH: 0580310004, 0580313057, 0580cn1018; **CITROËN:** ZXINIE 1.4L, DC04469380; **PEUGEOT:** 306 MOT TU1MDAL 1.1L, 306 MOT TU3MC DAL 1.4L; **PSA:** 1455, 07

APPLICATION / APLICACIÓN:

CITROËN: ZX 1360 cc 04.91-06.96, ZX 124cc 10.91-08.96, ZX 1580cc 03.91-12.94; **PEUGEOT:** 306 1124cc 02.1993+, 306 MOT TU1M DAL 1.1L, 306 MOT TU3MC DAL 1.4L



GCA10

FEATURES / CARACTERÍSTICAS: 12V 4.0BAR 90L/H

REPLACES / REEMPLAZA:

AIRTEX: E8368M, 8D0 906 089, 8D0 906 089A; VW: 4B0906087E, 8E0906087D; VDO: E22041094, E22-041-058Z

APPLICATION / APLICACIÓN:

AUDI: 80 Avant (8C,B4) 2.8L 09.91-01.96, A4 (8D2,B5) 1.6L 01.95-07.00, A4 (8D2,B5) 1.8L 01.95-11.00, A4 (8D2,B5) 1.8L 01.95-11.00, A4 (8D2,B5) 1.8 T 12.97-11.00, A4 (8D2,B5) 1.8 T 01.95-11.00, A4 (8D2,B5) 1.8 T 01.95-11.00, A4 (8D2,B5) 1.8 T 12.97-11.00, A4 (8D2,B5) 2.4L 03.97-11.00, A4 (8D2,B5) 2.4L 03.97-11.00, A4 (8D2,B5) 2.6L 01.95-11.00, A4 (8D2,B5) 2.6L 01.95-11.00, A4 (8D2,B5) 2.8L 09.95-07.97, A4 (8D2,B5) 2.8L 10.96-11.00, A4 (8D2,B5) 2.8L 10.96-11.00, A4 (8D2,B5) 2.8L 01.95-07.97, A4 (8D2,B5) S4 09.97-11.00, A4 Avant (8D5,B5) 1.6L 03.96-07.00, A4 Avant (8D5,B5) 1.8L 02.96-09.01, A4 Avant (8D5,B5) 1.8 quattro 01.96-09.01, A4 Avant (8D5,B5) 1.8 T 03.96-09.01, A4 Avant (8D5,B5) 1.8 T 12.97-09.01, A4 Avant (8D5,B5) 1.8 T quattro 12.97-09.01, A4 Avant (8D5,B5) 1.8 T quattro 01.96-09.01, A4 Avant (8D5,B5) 2.4L 03.97-09.01, A4 Avant (8D5,B5) 2.4 quattro 03.97-09.01, A4 Avant (8D5,B5) 2.6 quattro 02.96-09.01, A4 Avant (8D5,B5) 2.6 quattro 01.96-09.01, A4 Avant (8D5,B5) 2.8L 03.96-09.96, A4 Avant (8D5,B5) 2.8L 10.96-09.01, A4 Avant (8D5,B5) 2.8L quattro 10.96-09.01, A4 Avant (8D5,B5) 2.8 quattro 01.96-09.96, A4 Avant (8D5,B5) S4 quattro 09.97-09.01



GCA10B

FEATURES / CARACTERÍSTICAS:

REPLACES / REEMPLAZA:

VW/AUDI: 4B0906087P; MEAT & DORIA: 77482

APPLICATION / APLICACIÓN:

AUDI: A6 Mk2 Saloon 1.8T/2.7T 1997>2005, A6 Mk2 Avant/State 1.8T/2.7T 1997>2005, A6 Allroad Mk1 2.7T/4.2 V8 2000>2005



GCA11

FEATURES / CARACTERÍSTICAS: 12V 1.2BAR 95L/H

REPLACES / REEMPLAZA:

AIRTEX: E10217M, E10228; BOSCH: 986.580.209.986.580.000; MARELLI: 119751769963, 119766009900, 119751769960; SUA: SUA130, SUA431;

FIAT: 7736883, 7747117, 7752900, 46473394, 46518013; PIERBURG: 700468440, 7.00468.34.0;

APPLICATION / APLICACIÓN:

FIAT: PUNTO (176) 55 1.1L 09.93-09.99, PUNTO (176) 60 1.2L 03.94-09.99, PUNTO (176) 60 1.2L 01.94-09.99, PUNTO Convertible (176C) 60 1.2L 04.94-06.00, PUNTO Convertible (176C) 60 1.2L 05.95-06.00, PUNTO Van (76L) 1.1L 04.95-02.00;

LANCIA: Y (840A) 1.1L/1.2L 95-96



GCA20A

FEATURES / CARACTERÍSTICAS: 12V 3.0BAR 90LPH

REPLACES / REEMPLAZA:

DAEWOO: 96 183 061, 96 308 414, 96 391 617, 96 391 618

APPLICATION / APLICACIÓN:

DAEWOO: NUBIRA(KLAJ) 1.6L 16V 2005-1997, NUBIRA(KLAJ) 2.0L 16V 2005-1997, NUBIRA Saloon(KLAJ) 1.6L 16V 2005-1997, NUBIRA Saloon(KLAJ) 2.0L 16V 2005-1997, NUBIRA Wagon(KLAJ) 1.6L 16V 2005-1997, NUBIRA Wagon(KLAJ) 2.0L 16V 2005-1997



GCA20B

FEATURES / CARACTERÍSTICAS: 12V 3.0BAR 90LPH

REPLACES / REEMPLAZA:

DAEWOO: 96 344 792, 96 350 588, 96350580; MEAT&DORIA: 76532

APPLICATION / APLICACIÓN:

DAEWOO: LANOS(KLAT) 1.4 L 2005-1997, LANOS(KLAT) 1.6 L 16V 2005-1997, LANOS Saloon(KLAJ) 1.4 L 2005-1997, LANOS Saloon(KLAJ) 1.6 L 16V 2005-1997



GCA20C

FEATURES / CARACTERÍSTICAS: 12V 3.0BAR 90LPH

REPLACES / REEMPLAZA:

DAEWOO: 96 291 866, 96 291 867, 96 385 759, 96 391 618, 96 391 619

APPLICATION / APLICACIÓN:

DAEWOO: NUBIRA(KLAJ) 1.6L 16V 2005-1997, NUBIRA(KLAJ) 2.0L 16V 2005-1997, NUBIRA Saloon(KLAJ) 1.6L 16V 2005-1997, NUBIRA Saloon(KLAJ) 2.0L 16V 2005-1997, NUBIRA Wagon(KLAJ) 1.6L 16V 2005-1997, NUBIRA Wagon(KLAJ) 2.0L 16V 2005-1997



GCA20E

FEATURES / CARACTERÍSTICAS: 12V 3.0BAR 90LPH

REPLACES / REEMPLAZA:

DAEWOO: 96376973 (20380 V100), 96351053, 96350586

APPLICATION / APLICACIÓN:

DAEWOO: LEGANZA 2.0L, 2.2L



GCA20H

FEATURES / CARACTERÍSTICAS:

REPLACES / REEMPLAZA:

GM: 96255734, 96255739, 96964218; MEAT & DORIA: 77075

APPLICATION / APLICACIÓN:

DAEWOO: Leganza 2.0/2.2 1997>2002



GCA21

FEATURES / CARACTERÍSTICAS: 12V 5.0BAR 95L/H 7.5A

REPLACES / REEMPLAZA:

BOSCH: 0580453021, 0580464995; PIERBURG: 7.21913.50.0

APPLICATION / APLICACIÓN:

BMW: S 5 E28 520 I M20 B20 2.0L 01.88-12.90, 530 I M30 B30 2.0L 01.88-12.90, 518 g Touring M43 B18 1.8L 11.95-06.96, 518 I M40 B18 1.8L 09/89-12.94, 518 I M43 B18 1.8L 12.93-12.95, 518 I Touring M40 B18 1.8L 03.93-12.94, 520 I M50 B20 2.0L 09.89-12.95, 520 I Touring M50 B20 2.0L 11.91-12.96, I M50 B20 2.0L 10.90-12.94, S 5 E34 525 I M20 B25 2.5L 01.88-12.90, 525 I M20 B25 2.5L 01.88-12.90, 525 I M50 B25 2.5L 09.89-12.95, 525 I M50 B25 2.5L 10.90-12.96, 525 I Touring M50 B25 2.5L 11.91-12.96, 525 I IX M50 B25 2.5L 09.91-12.95, 525 I IX M50 B25 2.5L 02.92-12.96, 535 I M30 B35 3.5L 01.88-12.93, 535 I M30 B35 3.5L 01.89-12.94, M5 S38 B36 3.5L 10.88-12.95, M5 S38 B36 3.5L 11.90-12.94, S 7 E23 730 I M30 B30 3.0L 09.86-06.94, 735 I M30 B35 3.4L 09.86-12.92



GCA22

FEATURES / CARACTERÍSTICAS: 12V 3.5BAR 105L/H

REPLACES / REEMPLAZA:

AIRTEX: E10214M, E10228; BOSCH: 0986 580 208, 0986 580 207; MARELLI: 1197 5176 9962, 1197 5176 9962; FIAT: 7736883, 7752900, 7769932, 46427664, 46473394, 46427664, 7769932

APPLICATION / APLICACIÓN:

FIAT: PUNTO1108CC, BARCHETTA;
LANCIA: PUNTO



GCA24

FEATURES / CARACTERÍSTICAS: 12V 3.0BAR 100L/H

REPLACES / REEMPLAZA:

CITROËN/PEUGEOT: 00001525H8, 152581, 1525H8, 96254762, 9625476280, 96332946, 9633294680

MAGNETI MARELLI: 519730689900, GA2002

BOSCH: 0 986 580 310

S.I.D.A.T. S.r.l.: 72019

VALEO: 347004

APPLICATION / APLICACIÓN:

CITROËN: BERLINGO (B9) 1.680Kw 109CV 1587cc, BERLINGO (MF) 1.1 i (MFHDZ, MFHFX) 44Kw 60CV 1124cc, BERLINGO (MF) 1.4 i (MFKFX, MFKFW) 55Kw 75CV 1360cc, BERLINGO (MF) 1.4 i bivalent (MFKFW) 55Kw 75CV 1360cc, BERLINGO (MF) 1.6 16V (MFNFU) 80Kw 109CV 1587cc, BERLINGO Kasten (B9) 1.6 80Kw 109CV 1587cc, BERLINGO Kasten (M_) 1.4 i (MBKFX, MBKFW) 55Kw 75CV 1360cc, BERLINGO Kasten (M_) 1.4 i bivalent (MBKFW) 55Kw 75CV 1360cc, BERLINGO Kasten (M_) 1.6 16V (MBNFU) 80Kw 109CV 1587cc, XSARA PICASSO (N68) 1.6 65Kw 88CV 1587cc, XSARA PICASSO (N68) 1.6 70Kw 95CV 1587cc, XSARA PICASSO (N68) 1.8 16V 85Kw 115CV 1749cc, XSARA PICASSO (N68) 2.0 16V 100Kw 136CV 1997cc;
PEUGEOT: 206 CC (2D) 1.6 16V 80Kw 109CV 1587cc, 206 CC (2D) 2.0 S16 100Kw 136CV 1997cc, 206 Schragheck (2A/C) 1.1 40Kw 54CV 1124cc, 206 Schragheck (2A/C) 1.1 44Kw 60CV 1124cc, 206 Schragheck (2A/C) 1.4 16V 65Kw 88CV 1360cc, 206 Schragheck (2A/C) 1.4 i 55Kw 75CV 1360cc, 206 Schragheck (2A/C) 1.6 16V 80Kw 109CV 1587cc, 206 Schragheck (2A/C) 1.6 i 65Kw 89CV 1587cc, 206 Schragheck (2A/C) 2.0 S16 99Kw 135CV 1997cc, 206 Stufenheck 1.4 55Kw 75CV 1360cc, 206 Stufenheck 1.6 16V 80Kw 109CV 1587cc, 206 SW (2E/K) 1.1 44Kw 60CV 1124cc, 206 SW (2E/K) 1.4 55Kw 75CV 1360cc, 206 SW (2E/K) 1.4 16V 65Kw 88CV 1360cc, 206 SW (2E/K) 1.6 16V 80Kw 109CV 1587cc, 206 SW (2E/K) 2.0 16V 100Kw 136CV 1997cc, 607 (9D, 9U) 2.0 100Kw 136CV 1997cc, 607 (9D, 9U) 2.2 116Kw 158CV 2230cc, 607 (9D, 9U) 3.0 V6 24V 152Kw 207CV 2946cc, PARTNER Combispace (5F) 1.6 16V 80Kw 109CV 1587cc, PARTNER Kasten (5) 1.4 55Kw 75CV 1360cc



GCA24B

FEATURES / CARACTERÍSTICAS: 12V 3.0BAR 95L/H 6.0A

REPLACES / REEMPLAZA:

RENAULT: 8200027963, 8200683199

APPLICATION / APLICACIÓN:

RENAULT: CLIO II 1.2L 01.00-12.00, 1.4L 01.00-12.00, 1.6L 01.00-12.00



GCA24C

FEATURES / CARACTERÍSTICAS:

REPLACES / REEMPLAZA:

PEUGEOT: 1525R2, 9639114580; BOSCH: 0 986 580 351; MARELLI: 359001800520; MEAT&DORIA: 76852; PIERBURG: 7.02700.22.0

APPLICATION / APLICACIÓN:

PEUGEOT: Partner Box (5)1996/04

GCA24DHT

FEATURES / CARACTERÍSTICAS: 12V 3.0BAR 95L/H 6.0A

REPLACES / REEMPLAZA:

CITROEN/PEUGOET: 1525F7, 96 254 765 80; MEAT & DORIA: 76485

APPLICATION / APLICACIÓN:

CITROËN: Berlingo Multispace MPV Mk1 2.0 1999>2005, Berlingo Van Mk1 2.0 1999>2011, Xsara Picasso MPV 2.0 1999>2012;

PEUGEOT: 206 Hatch 1.9/2.0 1998>2001, 206 SW Estate 2.0 2002>, 607 Saloon 2.0/2.2/2.7 2000>2011, Partner Mk1 MPV/Van 2.0 2000>2008

GCA27

FEATURES / CARACTERÍSTICAS: 12V 3.0BAR 100L/H

REPLACES / REEMPLAZA:

WALBRO: TU200; AIRTEX: E2059M, E2063M, E2310M; FORD: F2UZ-9H307B, F3TZ-9A407A, F3UZ-9A407A, F4TZ-9A407A, F57Z-9H307B, F5UZ-9A407A, F67Z-9H307AA, F67Z-9H307BA, F6PZ-9H307EB, F6TZ-9A407AA

APPLICATION / APLICACIÓN:

FORD: TRUCK 89-97, 177 2.9L, 244 4.0L, 300 4.9L, 302 5.0L, 351 5.8L, 460 7.5L, BRONCO II 2.9L V6 4*4 01/88-08/90, F35 STRIPPED CHASSIS TRUCK 2.9L/4.0L/4.9L/5.0L/5.8L/7.5L 89-97;

MERCURY: MOUNTAINEER 302 5.0L 1997



GCA27A

FEATURES / CARACTERÍSTICAS:

REPLACES / REEMPLAZA:

FORD: E2059MN

APPLICATION / APLICACIÓN:

FORD: Bronco 1990-1996, Bronco II 1989-1990, E-150 1992-1996, E-250 1992-1996, E-350 1992-1996, Econo Line Superduty 1996, Superduty 1990-1997, F-150 1990-1996



GCA27B

FEATURES / CARACTERÍSTICAS: 12V 3.0BAR 100L/H

REPLACES / REEMPLAZA:

WALBRO: TU201; AIRTEX: E2064M; CARTER: P74108

APPLICATION / APLICACIÓN:

FORD: F150 PICK UP 4.9L/5.0L/5.8L 90-96, F250 PICK UP 4.9L/5.0L/5.8L/7.5L 90-97, TRUCK 177;

MERCURY: MOUNTAINEER 302 5.0L 1997



GCA27C

FEATURES / CARACTERÍSTICAS: 12V 3.0BAR 100L/H

REPLACES / REEMPLAZA:

AIRTEX: E10348M VW: 160919051H, 1J0919050, 1J0919050, 1J0919051C, 1J0919051E, 1J0919087C, 1J0919087D, 1J0919087H, 1J0919087J, 1J0919091C, 6X0919050, 7M3919050, 7M3919050A

APPLICATION / APLICACIÓN:

FORD



GCA28

FEATURES / CARACTERÍSTICAS: 12V 4.0BAR 110L/H

REPLACES / REEMPLAZA:

AIRTEX: E10348M; VW: 160919051H, 1J0919050, 1J0919051C, 1J0919051E, 1J0919087C, 1J0919087D, 1J0919087H, 1J0919087J, 1J0919091C, 6X0919050, 7M3919050, 7M3919050A

APPLICATION / APLICACIÓN:

AUDI: A3 (8L1) 1.6 09/96-08/00, A3 (8L1) 1.8 09/96->, A3 (8L1) 1.8 T 12/96->, A3 (8L1) 1.8 T 12/96->; SKODA: OCTAVIA (1U2) 1.6 09/96-09/00, OCTAVIA (1U2) 1.8 09/96->, OCTAVIA (1U2) 1.6 02/97->, OCTAVIA (1U2) 1.8 T 08/97->, OCTAVIA COMBI (1U5) 1.6 07/98->, OCTAVIA COMBI (1U5) 1.8 20V 07/98->, OCTAVIA COMBI (1U5) 1.8 T 07/98->;

VW: NEW BEETLE (9C1, 1C1) 2.0 01/98->, NEW BEETLE (9C1, 1C1) 1.6 10/99-09/00, NEW BEETLE (9C1, 1C1) 1.8 T 10/99->, BORA (1J2) 1.6 10/98-05/05, BORA (1J2) 2.0 10/98-05/05, BORA (1J2) 2.3 V5 10/98-10/00, BORA (1J2) 1.8 10/98-05/05, BORA (1J2) 1.4 16V 03/00-05/05, BORA (1J2) 2.8 V6 4MOTLON 03/99-05/05, BORA (1J2) 1.8 4MOTLON 02/99-05/05, BORA (1J2) 2.3 V5 4MOTLON 12/98-10/00, BORA RANCHERA FAMILIAR (1J6) 2.0 05/99-05/05, BORA RANCHERA FAMILIAR (1J6) 2.3 V5 05/99-10/00, BORA RANCHERA FAMILIAR (1J6) 1.6 05/99-05/05, BORA RANCHERA FAMILIAR (1J6) 2.3 V5 4MOTLON 05/99



GCA28B

FEATURES / CARACTERÍSTICAS: 12V 3.0BAR 90LPH

REPLACES / REEMPLAZA:

VDO: E22 041 095Z; VW: 1J0919087H, 1J0919051B, 1J0919051C, 1J0919087D, 6X0919056E; FORD: YM219H307DA, 96VW9H307BB

APPLICATION / APLICACIÓN:

AUDI: A3 1.6L/1.8L/1.8T 09/96>, TT 1.8T 10/98>; FORD: GALAXI 2.0L/2.3L/2.8L 06/98>03/00; SEAT: ALHAMBRA 1.8T/2.0L/2.8L 06/98>, AROSA 1.0L/1.4L 05/97>; SKODA: OCTAVIA 1.6L/1.8L/1.8T/2.0L 09/96>; VW: BORA 1.4/1.6/1.8/2.0L 10/98>, GOLF IV 1.4/1.6/1.8/2.0/2.3L 08/97>, LUPO 1.0L/1.4L 04/98>, NEW BEETLE 1.6L/2.0L/2.3L 10/99>09/00, SHARAN 1.8/2.0/2.8L 06/98>04/00



GCA28D

FEATURES / CARACTERÍSTICAS:

REPLACES / REEMPLAZA:

VW: 3B0919050, 3B0919050B; **MEAT & DORIA:** 76881

APPLICATION / APLICACIÓN:

SKODA: Superb Mk1 Saloon 1.9 2001>2008;

VW: Passat 1.9/2.0 2000>2005



GCA29

FEATURES / CARACTERÍSTICAS: 12V 4.0BAR 110L/H

REPLACES / REEMPLAZA:

FORD: 96VW 9H307 BB, YM 219H307 CA; **VW:** 1J0919051B, 1J0919087C, 6Q0919051F, 6X0919051C, 6X0919056, 6X0919087B, 7M0919051A, 6Q0 919 051C, 6Q0 919 051D, 6Q0 919 051G, 1J0 919 051K

APPLICATION / APLICACIÓN:

SEAT: CORDOBA(6L2) 1.2L, 1.4L 16V 10.02, CORDOBA(6L2) 1.4L 16V, 2.0 09.02, IBIZA III(6k1) 1.8T 20V Cupra 07.00-02.02, IBIZA IV(6L1) 1.2L, 1.4L 16V 02.02, IBIZA IV(6L1) 1.8 T Cupra R 01.04, SKODA: FABIA(6Y2) 1.2L 02.02, FABIA(6Y2) 1.4L 16V 12.99, FABIA Combi(6Y5) 1.2L 01.03, FABIA Combi(6Y5) 1.4L 16V 05.00, FABIA Combi(6Y5) 1.4L 16V 04.00, FABIA Praktik 1.2L 01.03, FABIA (6Y3) 1.2L 01.03, FABIA (6Y3) 1.4L 16V 12.99, FABIA(6Y3) 1.4L 16V 10.99;

VW: BORA (1J2) 1.6FSI 01.02-05.05, BORA (1J6) 1.6 FSI 01.02-05.05, GOLF IV(1J1) 1.6FSI 01.02-05.05, GOLF IV Variant (1J5) 1.6FSI 01.02, POLO (6N2) 1.4L 16V 10.99-09.01, POLO (9N_) 1.2L 01.02, POLO (9N_) 1.2L 10.01, POLO (9N_) 1.4L 16V 10.01, POLO Classic(6KV2) 75 1.4L 16V 10.99-09.01, POLO Variant(6KV5) 1.4L 16V 10.99-09.01



GCA31

FEATURES / CARACTERÍSTICAS: 12V 3.0BAR 90LPH

REPLACES / REEMPLAZA:

DAEWOO: 96 447 442, 96537125, 96406865; **BOSCH:** 0580 453610

APPLICATION / APLICACIÓN:

DAEWOO: LACETTI, NUBIRA;

BUICK: EXCELLE



GCA34

FEATURES / CARACTERÍSTICAS: 12V 3.0BAR 100L/H

REPLACES / REEMPLAZA:

LADA: 21102-11390009-20, 21083-1139007

APPLICATION / APLICACIÓN:

LADA

GCA34H

FEATURES / CARACTERÍSTICAS: 12V 3.0BAR 100L/H

REPLACES / REEMPLAZA:

LADA: 2123-1139009-20

APPLICATION / APLICACIÓN:

LADA: 2123



GCA36

FEATURES / CARACTERÍSTICAS: 12V 3.0BAR 100L/H

REPLACES / REEMPLAZA:

DAEWOO: 96563403, 96320232, 96518040

APPLICATION / APLICACIÓN:

DAEWOO: MATIZ (KLYA) 0.8L 09.98;

CHEVY: MATIZ 0.8L 03.05



GCA36B

FEATURES / CARACTERÍSTICAS: 12V 3.0BAR 100L/H

REPLACES / REEMPLAZA:

DAEWOO: 96570070

APPLICATION / APLICACIÓN:

DAEWOO



GCA39

FEATURES / CARACTERÍSTICAS: 12V 3.0BAR 80L/H

REPLACES / REEMPLAZA:

WALBRO: TU101; **CHRYSLER:** 4495163, 4682087, 4742671, 44P5002, 44P5391; **AIRTEX:** E7040M

APPLICATION / APLICACIÓN:

NEON: CHRYSLER 1996-2004, CHRYSLER 90-95, DODGE 90-95;

POLYMOUTH: 90-95



GCA49

FEATURES / CARACTERÍSTICAS: 12V 4.0BAR 110L/H

REPLACES / REEMPLAZA:

VDO: 228 223 002 209; VW: 380 919 051C

APPLICATION / APLICACIÓN:

VW: Passat (B5)



GCA62

FEATURES / CARACTERÍSTICAS: Internal fuel pump, 12V, 3Bar, 5.5A, 90 L/h.

For Petrol/Gasoline engines with Bosch module.

REPLACES / REEMPLAZA:

Bosch: F 000 TE1 054/055/184; Delphi: FH10032; GM: 25.165.013, 93.269.119, 93.277.518, 93.289.414; Magneti Marelli: MAM212; Siemens/VDO: 228 234 055R

APPLICATION / APLICACIÓN:

GM: ASTRA 1.8, 2.0i, 2.0i 16V 98>, Blazer, S10 2.2 (EFI/MPFI) 95>99, Corsa 1.0/1.4, Corsa Pick-up 1.6 (EFI) 94>96, Corsa Pick-up 1.0/1.6 (MPFI) 95>99, Corsa 1.0/1.6, Corsa Sedan, SW, Pick-up 1.6 (MPFI) 97>99, Vectra 2.2i 8/16V 97>, Vectra CD 2.0 8V (MPFI), 2.0 16V, GLS 2.0 (MPFI), GSI 2.0 16V 96>



GCA63

FEATURES / CARACTERÍSTICAS: 12V 3.0BAR 100L/H

REPLACES / REEMPLAZA:

AIRTEX: E3559M; WALBRO: U100; CHRYSLER: 4682086, 4682260, 4682761, 517988; DELPHI: FG0195

APPLICATION / APLICACIÓN:

CHRYSLER: DOWN& COUNTRY V6-3.3L 93-91; DODGE: CARAVAN L4-2.5L 93-91, GRAND CARAVAN V6-30L 93-92; PLYMOUTH: GRAND VOYAGER V6-30L 93-92, VOYAGER V6-3.3L 93-94



GCA67

FEATURES / CARACTERÍSTICAS:

REPLACES / REEMPLAZA:

RENAULT: 77 00 315 154, 77 01 472 425, 77 01 470 599; SIDAT: 71208

APPLICATION / APLICACIÓN:

RENAULT: KANGOO(KC0/1_) 1870cc Diesel 1997>2001, KANGOO RAPID(FC0/1) 1870cc 1997>2003



GCA68

FEATURES / CARACTERÍSTICAS:

REPLACES / REEMPLAZA:

OEM: VDO A2C59511657

APPLICATION / APLICACIÓN:

BMW



GCA68D

FEATURES / CARACTERÍSTICAS:

REPLACES / REEMPLAZA:

RENAULT: 8200689362, 8200130191

APPLICATION / APLICACIÓN:

RENAULT: Megane



GCA68E // NEW //

FEATURES / CARACTERÍSTICAS:

REPLACES / REEMPLAZA:

RENAULT: 8200029163

APPLICATION / APLICACIÓN:

RENAULT: MEGANE II (BM0/1_, CM0/1_) 2002/11 - 2011/01



GCA68F

FEATURES / CARACTERÍSTICAS:

REPLACES / REEMPLAZA:

BMW: 16 14 6 768 488, 16 14 1 184 279, 16 14 6 750 839, 16 14 6 755 878, 16 14 1 183 845; MEAT & DORIA: 76438

APPLICATION / APLICACIÓN:

BMW: 3-Series Saloon 316/318/320/330 1998>2005, Compact 318/320 2001>2005, Coupe 320/330 2003>2006, Estate 318/320/330 1999>2005



GCA69

FEATURES / CARACTERÍSTICAS:

REPLACES / REEMPLAZA:

BMW: 1180504, 1182842, 1182843, 16141180504, 16141182842, 16141182843; **MEAT & DORIA:** 76403 C

APPLICATION / APLICACIÓN:

BMW: 3-Series Saloon 316i/318i/320i/325i 1990>1998, Coupe 316i/318Cis/320Ci/325i/M3 3.0 1991>1999, Convertible 318i/320i/325i/M3 3.0 1993>1999

GCA69A

FEATURES / CARACTERÍSTICAS:

REPLACES / REEMPLAZA:

BMW: 16141182985, 16141183139, 16142228035, 16146758736; **MEAT & DORIA:** 76440

APPLICATION / APLICACIÓN:

BMW: 3-Series Saloon 316i/318i/320i/323i/325i/328i/M3 3.2 1990>1998, Coupe 316i/318is/320i/323i/325i/328i/M3 3.0/M3 3.2 1991>1999, Convertible 318i/320i/323i/325i/328i 1993>1999, Estate 318i/320i/323i/328i 1994>1999

GCA72

FEATURES / CARACTERÍSTICAS: 12V 3.0BAR 90L/H

REPLACES / REEMPLAZA:

NISSAN: 17040-VZ00A

APPLICATION / APLICACIÓN:

NISSAN: URBAN 2.5



GCA79

FEATURES / CARACTERÍSTICAS: 12V 3.0BAR 100L/H

REPLACES / REEMPLAZA:

FIAT: 46794446, 46831125, 46475719, 51709818, 19766029980, 7660200

APPLICATION / APLICACIÓN:

FIAT: Seicento (187) 01/1998>, Panda Van (141) 01/1986>02/2004>



GCA79A

FEATURES / CARACTERÍSTICAS:

REPLACES / REEMPLAZA:

FIAT: 51718054, 46794444, 46794445, 51709817, 71719572; **MEAT & DORIA:** 76610

APPLICATION / APLICACIÓN:

ALFA ROMEO: 156 SALOON 2.0 JTS 2002>2005;

FIAT: Panda Mk1 Hatch 1.1 1995>2003, Panda Mk2 Hatch 1.1 2003>



GCA79B

FEATURES / CARACTERÍSTICAS: 12V 3.0BAR 90L/H

REPLACES / REEMPLAZA:

FIAT: 46523407, 46523408, 46743677, 46812996, 46837061, 46845789, 51709816

APPLICATION / APLICACIÓN:

FIAT: PUNTO (176) 09/93>09/99, Punto Convertible (176C) 04/94>06/00, Punto (188) 09/99>, Punto Van (188AX) 02/00>



GCA80

FEATURES / CARACTERÍSTICAS: 12V 3.0BAR 100L/H

REPLACES / REEMPLAZA:

AIRTEX: E7094; **AC DELCO:** MU143; **WALBRO:** TU117; **BOSCH:** 67642, 67599; **CARTER:** P74706M; **DELPHI:** FG0215, FG0219

APPLICATION / APLICACIÓN:

CHRYSLER: GRAND VOYAGER V6-3.0L 2000, TOWN & COUNTRY V6-3.8L 00>96, VIYAGER L4-2.4L 2000; **DODGE:** CARAVAN L4-2.4L 00>96, GRAND CARAVAN V6-3.8L 00>96; **PLYMOUTH:** GRAND VOYAGER L4-2.4L 00>96, VOYAGER V6-3.8L 99>96



GCA80D

FEATURES / CARACTERÍSTICAS:

REPLACES / REEMPLAZA:

AIRTEX: E7129M; **BOSCH:** 67714; **CARTER:** P76033M; **DELPHI:** FG0484; **WALBRO:** TU174; **CHRYSLER/DODGE:** E7129M

APPLICATION / APLICACIÓN:

CHRYSLER: Grand Voyager V6-3.3L 00, Town & Country V6-3.3L 98>00, Voyager V6-3.3L 00; **DODGE:** Caravan V6-3.3L 98>00, Grand Caravan V6-3.3L 98>00; **PLYMOUTH:** Grand Voyager V6-3.3L 98>00, Voyager V6-3.3L 98>00



GCA80E

FEATURES / CARACTERÍSTICAS:

REPLACES / REEMPLAZA:

AIRTEX: E7144M; **BOSCH:** 67739, 67670; **CARTER:** P75026M; **DELPHI:** FG0425; **WALBRO:** TU153; **CHRYSLER/DODGE:** E7144M

APPLICATION / APLICACIÓN:

CHRYSLER: Town & Country V6-3.3L 01>03, Voyager V6-3.8L 01>03; **DODGE:** Caravan L4-2.4L 01>03, Grand Caravan V6-3.8L 01>03



GCA80F

FEATURES / CARACTERÍSTICAS:

REPLACES / REEMPLAZA:

AIRTEX: E7146M; **BOSCH:** 67701, 67688, 67679; **CARTER:** P76032M; **DELPHI:** FG0483; **WALBRO:** TU169

APPLICATION / APLICACIÓN:

CHRYSLER: Town & Country V6-3.3L 01>03, Voyager V6-3.3L 01>03; **DODGE:** Caravan V6-3.3L 01>03, Grand Caravan V6-3.3L 01>03



GCA81

FEATURES / CARACTERÍSTICAS: 12V 3.0BAR 90L/H

REPLACES / REEMPLAZA:

PIERBURG: 7.21868.01.0, 7.21926.52.0; **VW:** 043-919-051

APPLICATION / APLICACIÓN:

VW: KAEFER 1600I (MEXICO) 1992>2003



GCA84

FEATURES / CARACTERÍSTICAS: 12V 3.0BAR 95L/H 6.0A

REPLACES / REEMPLAZA:

DACIA: 172024388R, 6001547605, 8200307403; **RENAULT:** 172024388R, 8200307403, 8200704685, 8200900036, 8200903680, 8200903683; **ROBERT BOSCH GMBH:** 0 986 580 369; **S.I.D.A.T. S.r.l.:** 72268; **VALEO SERVICE DEUTSCHLAND GMBH:** 347066

APPLICATION / APLICACIÓN:

DACIA: LOGAN (LS_) 1.4 (LSOA, LSOC, LSQE, LSOG) 55Kw 75CV 1390cc / 1.6 (LSOB, LSOD, LSOF, LSOH) 64Kw 87CV 1598cc, LOGAN EXPRESS (FS_) 1.455Kw 75CV 1390cc, LOGAN MCV (KS_) 1.4 55Kw 75CV 1390cc / 1.6 64Kw 87CV 1598cc, LOGAN Pick-up (US_) 1.6 64Kw 87CV 1598cc; **RENAULT:** LOGAN I (LS_) 1.4 55Kw 75CV 1390cc / 1.6 64Kw 87CV 1598cc, LOGAN I Kombi (KS_) 1.4 55Kw 75CV 1390cc / 1.6 64Kw 87CV 1598cc



GCA84A

FEATURES / CARACTERÍSTICAS:

REPLACES / REEMPLAZA:

NISSAN: 17040-AX000, 17040-AX010, 17040-9U01B, 17040-9U01C; **MEAT & DORIA:** 76851

APPLICATION / APLICACIÓN:

NISSAN: Micra Mk3 1.0/1.2/1.4 16V 2003>2010, Micra IV 1.2 2010>, Micra C+C Convertible 1.4/1.6 2005>, Note 1.4/1.6 2006>2012



GCA84C01

FEATURES / CARACTERÍSTICAS:

REPLACES / REEMPLAZA:

DACIA: 172022047R; **MEAT & DORIA:** 77414

APPLICATION / APLICACIÓN:

DACIA: Sandero II 1.2 2012>



GCA84D // NEW //

FEATURES / CARACTERÍSTICAS:

REPLACES / REEMPLAZA:

RENAULT: 8200727740, 8200263038; **MEAT & DORIA:** 76954

APPLICATION / APLICACIÓN:

RENAULT: Clio Mk3 Hatch 1.2/1.4/1.6/2.0 16V 2005>, Clio Mk3 Estate 1.2/1.4/1.6 16V 2008>

GCA85

FEATURES / CARACTERÍSTICAS: 12V 3.0BAR 95L/H 6.5A

REPLACES / REEMPLAZA:

...

APPLICATION / APLICACIÓN:

PEUGEOT: 405





GCA86

FEATURES / CARACTERÍSTICAS: 12V 3.0BAR 130L/H

REPLACES / REEMPLAZA:

PEUGEOT: 1525Q6, 1525V0, 1525Q7

APPLICATION / APLICACIÓN:

PEUGEOT: 206



GCA88B

FEATURES / CARACTERÍSTICAS: ...

REPLACES / REEMPLAZA:

CITROËN: 1525QW, 9680353580, 9681285980

APPLICATION / APLICACIÓN:

CITROËN: C4 Coupe (LA_) 2004/11 - 2011/07



GCA89

FEATURES / CARACTERÍSTICAS: ...

REPLACES / REEMPLAZA:

AIRTEX: E7167M; DELPHI: FG0427; BOSCH: 67690, 67676; CARTER: P76047M, P75032M; WALBRO: TU155

APPLICATION / APLICACIÓN:

CHRYSLER: Sebring V6-2.7L 03>06; DODGE: Stratus V6-2.7L 03>06



GCA91

FEATURES / CARACTERÍSTICAS: 12V 3.0BAR 100L/H

REPLACES / REEMPLAZA:

RENAULT: 8200 704 685; MARELLI: 0974 690 990005; NISSAN: 17040-CH000

APPLICATION / APLICACIÓN:

NISSAN



GCA92

FEATURES / CARACTERÍSTICAS: ...

REPLACES / REEMPLAZA:

RENAULT: 82 00 128 479; MARELLI: SUA 141; BOSCH: 0 986 580 292; SIDAT: 7118

APPLICATION / APLICACIÓN:

RENAULT: CLIO II 1.5dCi 01.04, CLIO II 1.5dCi 06.01, CLIO II 1.5dCi 06.01, CLIO II 1.5dCi 06.01



GCA94

FEATURES / CARACTERÍSTICAS: 12V 3.5 BAR 120L/H

REPLACES / REEMPLAZA:

BOSCH: 0 986 580 129; PIERBURG: 7.22013.02.0; BMW: 1 183 176, 1 183 216, 16 14 1 183 176, 16 14 183 216, 16 14 6 752 368; MERCEDES-BENZ: A 000 470 17 94, 000 470 17 94; AIRTEX: E10372

APPLICATION / APLICACIÓN:

RENAULT: CLIO II 1.5dCi 01.04, CLIO II 1.5dCi 06.01, CLIO II 1.5dCi 06.01, CLIO II 1.5dCi 06.01



GCA95

FEATURES / CARACTERÍSTICAS: ...

REPLACES / REEMPLAZA:

9480152

APPLICATION / APLICACIÓN:

VOLVO: 850, C70, S70, V70, S70 GLT, V70 GLT, 850 R, V70 R, 850 T-5, 850 T-5R, V70 T5, 850 TURBO



GCA96

FEATURES / CARACTERÍSTICAS: ...

REPLACES / REEMPLAZA:

VW: 25060-VW000

APPLICATION / APLICACIÓN:

NISSAN: URBAN 02>07



GCA97

FEATURES / CARACTERÍSTICAS: ...

REPLACES / REEMPLAZA:

AIRTEX: E8502M; **BOSCH:** 69701; **NISSAN:** 17040-8U000

APPLICATION / APLICACIÓN:

NISSAN: Sentra L4-1.8L 03>06, Sentra L4-2.5L 02>06



GCA105BHT

FEATURES / CARACTERÍSTICAS: ...

REPLACES / REEMPLAZA:

MERCEDES BENZ: A9064700994, A9064703694, 9064700994, 9064703694; **MEAT & DORIA:** 77290

APPLICATION / APLICACIÓN:

MERCEDES BENZ: Sprinter 3-T VAN 2006>, Sprinter 4.6-t Box 2006>, Sprinter 3-T FLATBED 2006>, Sprinter 4.6-t Platform/Chassis 2006>, Sprinter 3.5-T Minibus 2006>, Sprinter 5-T VAN 2006>, Sprinter 3.5-T VAN 2006>, Sprinter 5-T FLATBED 2006>, Sprinter 3.5 FLATBED 2006>



GCA105CHT

FEATURES / CARACTERÍSTICAS: ...

REPLACES / REEMPLAZA:

MERCEDES BENZ: A 906 470 20 94, A 906 470 33 94, 906 470 20 94, 906 470 33 94; **MEAT & DORIA:** 77205

APPLICATION / APLICACIÓN:

MERCEDES BENZ: Sprinter 3-T Minibus 2006 >, Sprinter 3.5 FLATBED 2006>, Sprinter 3-T VAN 2006 >, Sprinter 4.6-t Box 2006>, Sprinter 3-T FLATBED 2006> Sprinter 4.6-t Platform/Chassis 2006>, Sprinter 3.5-T Minibus 2006 >, Sprinter 5-T VAN 2006 >, Sprinter 3.5-T VAN 2006>, Sprinter 5-T FLATBED 2006>



GCA106AHT

FEATURES / CARACTERÍSTICAS: ...

REPLACES / REEMPLAZA:

BMW: 16146756184, 16146766176, 16146759955; **MEAT & DORIA:** 76887

APPLICATION / APLICACIÓN:

MINI: Mini Mk2 One/Cooper 2001>2006

GCA106HT

FEATURES / CARACTERÍSTICAS: ...

REPLACES / REEMPLAZA:

AUDI: 8E0919051BC, 8E0919051BH, 8E0919051AB, 8E0919051CG

APPLICATION / APLICACIÓN:

AUDI: A4 1.8/3.0 V6 2004>2006



GCA112AHT

FEATURES / CARACTERÍSTICAS: ...

REPLACES / REEMPLAZA:

VOLKSWAGEN: 7L6919087A, 7L6919087E, 7L6919087F; **MEAT & DORIA:** 77465

APPLICATION / APLICACIÓN:

VW: Touareg 3.2 V6/3.6 V6/4.2 V8/6.0 2002>2010, Touareg 3.6 V6/4.2 V8 2010>2018



GCA112HT

FEATURES / CARACTERÍSTICAS: ...

REPLACES / REEMPLAZA:

VOLKSWAGEN: 7L6919087B, 7L6919087G, 7L0919087F; **MEAT & DORIA:** 77466

APPLICATION / APLICACIÓN:

VW: Touareg 3.2 V6/3.6 V6/4.2 V8/6.0 2002>2010



GCA113HT

FEATURES / CARACTERÍSTICAS: ...

REPLACES / REEMPLAZA:

VOLKSWAGEN: 7L8919087B; **MEAT & DORIA:** 77409

APPLICATION / APLICACIÓN:

AUDI: Q7 3.0/3.6/4.2 2006>2015

VW: Touareg 3.6 V6/4.2 V8 2005>2010



GCA117

FEATURES / CARACTERÍSTICAS: ...

REPLACES / REEMPLAZA:

FG00518-11B1, 25187045

APPLICATION / APLICACIÓN:

-



GCA120

FEATURES / CARACTERÍSTICAS: 12V 3.0BAR 90L/H 6.0A

REPLACES / REEMPLAZA:

DELPHI: FG0902-12B1; FORD: 1062046, 1062079, 1066412, 1069087, 1071533, 1074103, 1079855, 1106355, 1135288, 1237255, 1320565, 1339027, 1096174, 1237431, 1388671, 98AP9H307AL

APPLICATION / APLICACIÓN:

FORD



GCA121

FEATURES / CARACTERÍSTICAS:

REPLACES / REEMPLAZA:

PEUGEOT: 152560

APPLICATION / APLICACIÓN:

PEUGEOT: 3061993-2003



GCA124C

FEATURES / CARACTERÍSTICAS: ...

REPLACES / REEMPLAZA:

DODGE: E7184M, 5135549AA

APPLICATION / APLICACIÓN:

CHRYSLER: ASPEN 2007;

DODGE: DURANGO 2004-2007



GCA133AHT

FEATURES / CARACTERÍSTICAS:

REPLACES / REEMPLAZA:

VOLVO: 30761745, 30792447, 30792857, 31261133

APPLICATION / APLICACIÓN:

VOLVO: S60 Saloon 2.4 2004>2010, V70 Mk2 Estate 2.4 2004>2007, XC90 SUV 2.5 2002>2014



GCA133BHT

FEATURES / CARACTERÍSTICAS:

REPLACES / REEMPLAZA:

VOLVO: 31261127, 30792852, 30761742, 30769007, 31812529, 30645699, 30645977, 31261127, 8683147, 8629783; MEAT & DORIA: 77165

APPLICATION / APLICACIÓN:

VOLVO: S60 Saloon 2.0/2.4/2.5 2000>2010, S80 Mk1 Saloon 2.0/2.4/2.5/3.0 1999>2006, XC70 Mk1 Estate 2.5 2002>2007, XC90 SUV 2.5 2002>2014



GCA133C

FEATURES / CARACTERÍSTICAS:

REPLACES / REEMPLAZA:

BOSCH: 0 580 313 012; FIAT: 60628082; MEAT & DORIA: 76551

APPLICATION / APLICACIÓN:

ALFA ROMEO: 156 Saloon 1.6/1.8/2.0/2.5 1997>2005, 156 Estate 1.6/1.8/2.0/2.5 1997>2006



GCA133D

FEATURES / CARACTERÍSTICAS:

REPLACES / REEMPLAZA:

BOSCH: 0 580 313 092; **FIAT:** 46539548, 46739809, 46757664, 46832868, 46842972; **MEAT & DORIA:** 76568

APPLICATION / APLICACIÓN:

LANCIA: Y 1.2 16V 1996>2003



GCA133HT

FEATURES / CARACTERÍSTICAS:

REPLACES / REEMPLAZA:

VOLVO: 30636490, 30645538, 30714850, 30722630, 30769013, 31261128, 8683329; **MEAT & DORIA:** 77203

APPLICATION / APLICACIÓN:

VOLVO: S60 Saloon 2.0/2.4 2000>2010, S80 Mk1 Saloon 2.0/2.4/2.8/2.9/3.0 1998>2006, V70 Mk2 Estate 2.0/2.3/2.4 1999>2007, XC70 Mk1 Estate 2.4 2000>2002



GCA133HT

FEATURES / CARACTERÍSTICAS:

REPLACES / REEMPLAZA:

VOLVO: 30636490, 30645538, 30714850, 30722630, 30769013, 31261128, 8683329; **MEAT & DORIA:** 77203

APPLICATION / APLICACIÓN:

VOLVO: S60 Saloon 2.0/2.4 2000>2010, S80 Mk1 Saloon 2.0/2.4/2.8/2.9/3.0 1998>2006, V70 Mk2 Estate 2.0/2.3/2.4 1999>2007, XC70 Mk1 Estate 2.4 2000>2002

GCA135

FEATURES / CARACTERÍSTICAS:

REPLACES / REEMPLAZA:

FIAT/LANCIA: 46472382

APPLICATION / APLICACIÓN:

FIAT: 2004;

LANCIA: 2006



GCA140A

FEATURES / CARACTERÍSTICAS:

REPLACES / REEMPLAZA:

BOSCH: 0 986 580 381; **CITROËN/PEUGEOT:** 1525GY, 1525PY, 1607401980, 96570359, 9657035980, 9684934480; **MEAT & DORIA:** 76998

APPLICATION / APLICACIÓN:

CITROËN: C3 Picasso MPV 1.4/1.6 2009>;

PEUGEOT: 207 Hatch 1.4/1.6 2006>, 207 CC Convertible 1.6 16V 2007>, 207 CW Estate 1.4/1.6 2007>, RCZ 1.6 16V 2010>2015



GCA140B

FEATURES / CARACTERÍSTICAS:

REPLACES / REEMPLAZA:

RENAULT: 172020255R, 172025557R; **MEAT & DORIA:** 77364

APPLICATION / APLICACIÓN:

RENAULT: Master III Bus 2.3 dCi 2011>, Master III Box 2.3 dCi 2010>



GCA140C

FEATURES / CARACTERÍSTICAS:

REPLACES / REEMPLAZA:

RENAULT: 172026063R, 172026934R; **MEAT & DORIA:** 77365

APPLICATION / APLICACIÓN:

RENAULT: Master III Bus 2.3 dCi 2011>, Master III Box 2.3 dCi 2010>



GCA143HT

FEATURES / CARACTERÍSTICAS:

REPLACES / REEMPLAZA:

BMW: 16147194207; **MEAT & DORIA:** 77803E

APPLICATION / APLICACIÓN:

BMW: 128i, 328i, 328xi, 328Ci

GCA144

FEATURES / CARACTERÍSTICAS:

REPLACES / REEMPLAZA:

BMW: E8688M

APPLICATION / APLICACIÓN:

BMW: 1SERIESM 2011, 128I 2008-2013, 130I 2006-2010, 135I 2008-2013, 135IS 2013, 323I 2006-2011, 325I 2006-2011, 325XI 2006, 328I 2007-2013, **328XI** 2007-2008, 330I 2006, 330XI 2006, 335I 2007-2013, 335IS 2011-2013, 335XI2007-2008, X12012-2015

GCA146

FEATURES / CARACTERÍSTICAS:

REPLACES / REEMPLAZA:

RENAULT: 7700422036, 7700426211; **AIRTEX:** E10442M; **DELPHI:** FG1050-12B1; **ERA:** 775069; **MEAT&DORIA:** 76829; **PIERBURG:** 7.02550.17.0; **SIDAT:** T2222

APPLICATION / APLICACIÓN:

RENAULT: Laguna I (B56_, 556_) 1993/11 - 2001/03

GCA146B

FEATURES / CARACTERÍSTICAS:

REPLACES / REEMPLAZA:

RENAULT: 7700429144

APPLICATION / APLICACIÓN:

RENAULT: Megane Scenic (JA0/1_) 1996/10 - 2001/12

GCA146C

FEATURES / CARACTERÍSTICAS:

REPLACES / REEMPLAZA:

RENAULT: 8200016909; **MEAT & DORIA:** 76848

APPLICATION / APLICACIÓN:

RENAULT: Laguna Mk1 Hatch 1.6/1.8/2.0 1995>2001, Laguna Mk1 Estate 1.6/1.8/2.0 1995>2001



GCA146D

FEATURES / CARACTERÍSTICAS:

REPLACES / REEMPLAZA:

RENAULT: 7700426211, 7700422036; **MEAT & DORIA:** 76829

APPLICATION / APLICACIÓN:

RENAULT: Megane Mk1 Hatch 1.6/2.0 1996>2003, Megane Mk2 Hatch 1.6/2.0 2002>2009, Megane Classic Saloon 1.6 1996>1999, Megane Mk2 Saloon 1.6/2.0 2003>, Megane Mk1 Coupe 1.6 1996>1999, Megane Mk2 Estate 1.6/2.0 2003>2009, Megane Convertible 1.6/2.0 1996>2003, Megane Mk2 Convertible 1.6/2.0/2.0 Turbo 2003>2009, Scenic Mk1 MPV 1.6/2.0 1996>1999



GCA153B

FEATURES / CARACTERÍSTICAS: ...

REPLACES / REEMPLAZA:

AIRTEX: E3609M

APPLICATION / APLICACIÓN:

-



GCA156

FEATURES / CARACTERÍSTICAS: ...

REPLACES / REEMPLAZA:

777020002181, FG1299-11B1

APPLICATION / APLICACIÓN:

TOYOTA



GCA157

FEATURES / CARACTERÍSTICAS: ...

REPLACES / REEMPLAZA:

CHEVROLET: E3806M

APPLICATION / APLICACIÓN:

CHEVROLET: HHR2009-2011

GCA160

FEATURES / CARACTERÍSTICAS: ...

REPLACES / REEMPLAZA:

VW: 7.00468.84.0

APPLICATION / APLICACIÓN:

VW CABRIO III (1E7) 2.0 1991 -2010



GCA163D

FEATURES / CARACTERÍSTICAS: ...

REPLACES / REEMPLAZA:

MERCEDES BENZ: A2114701494, A2114702994, A2114704194, 2114701494, 2114702994, 2114704194; MEAT & DORIA: 77109

APPLICATION / APLICACIÓN:

MERCEDES BENZ: CLC Class 280/300/350/500/55 AMG 2004>2010, E-Class Saloon E200/E230/E240/E280/E320/E350/E500 2002>2008, E-Class Estate E200/E230/E240/E280/E320/E350/E500 2003>2009



GCA164

FEATURES / CARACTERÍSTICAS: ...

REPLACES / REEMPLAZA:

77010-0K041

APPLICATION / APLICACIÓN:

TOYOTA



GCA168

FEATURES / CARACTERÍSTICAS: ...

REPLACES / REEMPLAZA:

3111-3K300

APPLICATION / APLICACIÓN:

HYUNDAI: Sonata



GCA168A

FEATURES / CARACTERÍSTICAS: ...

REPLACES / REEMPLAZA:

3111-09000

APPLICATION / APLICACIÓN:

HYUNDAI: Sonata



GCA169

FEATURES / CARACTERÍSTICAS: ...

REPLACES / REEMPLAZA:

3110-2E300

APPLICATION / APLICACIÓN:

HYUNDAI: Tucson



GCA180

FEATURES / CARACTERÍSTICAS: ...

REPLACES / REEMPLAZA:

HYUNDAI: 311102D030

APPLICATION / APLICACIÓN:

HYUNDAI: ELANTRA (XD) 2000/06 - 2006/07

GCA185

FEATURES / CARACTERÍSTICAS: ...

REPLACES / REEMPLAZA:

FIAT: 46798695, 1540961, 9S51-9275A-A; **BOSCH:** 0 986 580 947; **DELPHI:** FG1061-12B1; **MEAT&DORIA:** 76877, 77070, 77330; **PIERBURG:** 7.02701.88.0; **VDO:** 228-235-106-001Z

APPLICATION / APLICACIÓN:

FIAT: Panda (169) 1.1 2003-2004

GCA185A

FEATURES / CARACTERÍSTICAS: ...

REPLACES / REEMPLAZA:

FORD: 1506989, 6G919H307AF; **MEAT & DORIA:** 77406

APPLICATION / APLICACIÓN:

FORD: Galaxy Mk2 2.0/2.3 2006>2015, Mondeo Mk4 Hatch 1.6Ti/2.0 2007>2015, Mondeo Mk4 Saloon 1.6Ti/2.0 2007>2015, Mondeo Mk4 Estate 1.6Ti/2.0 2007>2015, S-Max 2.0 2006>2014



GCA187C

FEATURES / CARACTERÍSTICAS: ...

REPLACES / REEMPLAZA:

FIAT: 46838198; **MEAT & DORIA:** 76929

APPLICATION / APLICACIÓN:

FIAT: Idea MPV 1.2/1.4 2003>, Punto Mk2 Hatch 1.2/1.4 1999>2012;

LANCIA: Musa 1.4 2004>2012, Ypsilon 1.2/1.4 2003>2011

GCA187D

FEATURES / CARACTERÍSTICAS: ...

REPLACES / REEMPLAZA:

FIAT: 46796398, 46807425, 46837359; **MEAT & DORIA:** 77697

APPLICATION / APLICACIÓN:

FIAT: Stilo Hatch 1.6/1.8/2.4 2001>2007

GCA187E

FEATURES / CARACTERÍSTICAS: ...

REPLACES / REEMPLAZA:

FIAT: 51868774, 55700362; **MEAT & DORIA:** 76933

APPLICATION / APLICACIÓN:

FIAT: Grande Punto 1.2/1.4 2005>2015, Punto Evo 1.2/1.4 2009>2012, Punto 1.2/1.4 2012>;

ALFA ROMEO: Mito 1.4 2008>2013

GCA187F

FEATURES / CARACTERÍSTICAS: ...

REPLACES / REEMPLAZA:

CITROËN/PEUGEOT: 1525 PR; **FIAT:** 51787161, 629100612; **MEAT & DORIA:** 77118

APPLICATION / APLICACIÓN:

CITROËN: Nemo Estate 1.4 2009>;

PEUGEOT: Bipper Van/Tepee 1.4 2008>;

FIAT: Fiorino Van 1.4 2007>, Fiorino Qubo 1.4 2008>

GCA187G

FEATURES / CARACTERÍSTICAS: ...

REPLACES / REEMPLAZA:

GM: 13216318, 13327783, 55702101; **MEAT & DORIA:** 77037

APPLICATION / APLICACIÓN:

GM: Corsa D Hatch 1.0/1.2/1.4 2006>2014, Corsa D Van 1.0/1.2 2006>2014



GCA189G01HT

FEATURES / CARACTERÍSTICAS: ...

REPLACES / REEMPLAZA:

VW: 1K0919050AB, 1K0919050J, 1K0919050Q, 1K0919050D, 1K0919050G; **MEAT & DORIA:** 76836

APPLICATION / APLICACIÓN:

AUDI: Mk2 Hatch (3 door) 2003>2013, A3 Mk2 Hatch (5 door) 2004>2015, A3 Convertible 2008>2013, A3 2012, A3 Sportback 2012>;

SEAT: Altea MPV 2004>, Altea XL MPV 2006>, Leon Mk2 Hatch 2005>2013, Leon 2012>, Toledo Mk3 MPV 2004>2009;

SKODA: Octavia Mk2 Hatch/Estate 2004>2013, Superb Mk2 2008>2015, Yeti 2009>2017;

VW: Beetle 2011>, Beetle Convertible 2011>, EOS Convertible 2006>2015, Golf Mk5 Hatch/Estate 2003>2009, Golf VI 2008>2013, Golf VI Variant 2009>2013, Golf VI Convertible 2011>2016, Golf VII 2012>, Golf VII Variant 2013>, Jetta Mk3 Saloon 2004>2010, Jetta IV 2008>, Scirocco Mk3 Coupe 2008>2017



GCA189HHT

FEATURES / CARACTERÍSTICAS: ...

REPLACES / REEMPLAZA:

VW: 1K0 919 051 AE, 1K0 919 051 AQ, 1K0 919 051 BH, 1K0 919 051 CL; **MEAT & DORIA:** 77007

APPLICATION / APLICACIÓN:

AUDI: A1 2010>2018, A1 Sportback 2011>2018, A3 Mk2 Hatch (3 door) 2003>2013, A3 Mk2 Hatch (5 door) 2004>2015, A3 Convertible 2008>2013, A3 2012>, A3 Sportback 2012>, TT Roadster Cabrio Mk2 2007>2014;

SEAT: Altea MPV 2004>, Altea XL MPV 2006>, Leon Mk2 Hatch 2005>2013, Leon 2012>;

SKODA: Octavia Mk2, Octavia III Combi 2012>, Yeti 2009>2017;

VW: Beetle 2011>, Beetle Convertible 2011>, Caddy IV Estate/Box 2015>, EOS Convertible 2006>2015, Golf Mk5 Hatch 2003>2009, Golf VI 2008>2013, Golf VI Variant 2009>2013, Golf VI Convertible 2011>2016, Golf VII 2012>, Golf VII Variant 2013>, Golf Mk5 Plus 2004>2013, Passat Variant 2010>2015, Passat Alltrack 2012>2014, Scirocco Mk3 Coupe 2008>2017, Touran 2010>2015



GCA189JHT

FEATURES / CARACTERÍSTICAS: ...

REPLACES / REEMPLAZA:

VW: 1J0919087S

APPLICATION / APLICACIÓN:

VW: Golf IV 1.8T/2.0, Jetta IV 1.8T/2.0, Jetta IV GLI 1.8T, New Beetle 1.8T/2.0/2.5



GCA189LHT

FEATURES / CARACTERÍSTICAS: ...

REPLACES / REEMPLAZA:

VW: 1K0919051AP; **MEAT & DORIA:** 77041

APPLICATION / APLICACIÓN:

AUDI: A1 2010>2018, A1 Sportback 2011>2018, A3 Mk2 Hatch (3 door) 2003>2013, A3 Mk2 Hatch (5 door) 2004>2015, A3 Convertible 2008>2013, A3 2012>, A3 Sportback 2012>, TT Roadster Cabrio Mk2 2007>2014;

SEAT: Altea MPV 2004>, Altea XL MPV 2006>, Leon Mk2 Hatch 2005>2013, Leon 2012>;

SKODA: Octavia Mk2 Estate 2004>2013, Octavia III Combi 2012>, Yeti 2009>2017;

VW: Beetle 2011>, Beetle Convertible 2011>, EOS Convertible 2006>2015, Golf VI 2008>2013, Golf VI Variant 2009>2013, Golf VI Convertible 2011>2016, Golf VII 2012>, Golf VII Variant 2013>, Golf Mk5 Plus 2004>2013, Passat Variant 2010>2015, Passat Alltrack 2012>2014, Scirocco Mk3 Coupe 2008>2017, Touran 2010>2015



GCA191AHT

FEATURES / CARACTERÍSTICAS: ...

REPLACES / REEMPLAZA:

VW: 8E0919051CQ, 8E0919051AL; **MEAT & DORIA:** 77479

APPLICATION / APLICACIÓN:

AUDI: A4 Convertible 2.0/3.2/RS4 2006>2009, A4 Mk3 Saloon/Avant/Estate 2.0/3.2/RS4 2004>2008



GCA201

FEATURES / CARACTERÍSTICAS: 12V 3.0BAR 100L/H

REPLACES / REEMPLAZA:

ACDELCO: U1756/MU110; **AIRTEX:** E3943M; **BOSCH:** 67349; **VW:** 19177259; **GM:** 19177259/ 25178729; **CARTER:** P74755M

APPLICATION / APLICACIÓN:

CHEVROLET: S10 L4-2.2L 00-97;

GMC: SONOMAL4-2.2L 00-97;

ISUZU: HOMBRE L4-2.2L 00-97



GCA202

FEATURES / CARACTERÍSTICAS: 12V 3.5BAR 78L/H

REPLACES / REEMPLAZA:

ACDELCO: MU1753, AIRTEX: E3956M, GM: 19177242

APPLICATION / APLICACIÓN:

CHEVROLET: C3500 V8-7.4L 00-98, C3500 V8-5.7L 00-99, C3500V8-8.1L 2002-2001, K3500 V8-7.4L 00-98, K3500 V8-5.7L 00-98;
GMC: C3500 V8-8.1L 2002-2001, K3500 V8-7.4L 2000-1998, K3500 V8-5.7L 2000-1998, SIERRA 3500 V8-8.1L 2002-2001



GCA203

FEATURES / CARACTERÍSTICAS: 12V 4.25BAR 150L/H

REPLACES / REEMPLAZA:

ACDELCO: MU1749, MU158, MU1067; AIRTEX: E3966M; BOSCH: 67364; DELPHI: FG0098; GM:19177232 25314352; CARTER: P74778M

APPLICATION / APLICACIÓN:

CHEVROLET: EXPRESS 1500V8-5.0L 2001-1997, EXPRESS 1500 V8-5.7L 2002-1997, EXPRESS 1500 V6-4.3L 2002-1997 EXPRESS 2500 V8-5.0L 2001-1997, EXPRESS 2500 7 V8-5.7L 2002-1997, EXPRESS 2500 V6-4.3L 2002-1997, EXPRESS 3500 V8-7.4L 2000-1997, EXPRESS 3500 V8-8.1L 2002-1997, EXPRESS 3500 V8-5.7L 2002-1997;
GMC: SAVANA 1500 V8-5.0L 2001-1997, SAVANA 1500 V8-5.7L 2002-1997, SAVANA 1500 V8-5.7L 2002-1997, SAVANA 2500 V8-5.0L 2001-1997, SAVANA 2500 V8-5.7L 2002-1997 SAVANA 2500 V8-5.7L 2002-1997, SAVANA 3500 V8-8.1L 2002-2001, SAVANA 3500 V6-4.3L 1997, SAVANA 3500 V8-5.7L 2002-1997



GCA204

FEATURES / CARACTERÍSTICAS: 12V 4.25BAR 150L/H

REPLACES / REEMPLAZA:

ACDELCO: MU1613, MU1516, MU1089, MU86; AIRTEX: E3500M; BOSCH: 67305; DELPHI: FG0053; GM: 19153711, 19121626, 25176865, 25345026; CARTER: P74835M

APPLICATION / APLICACIÓN:

CHEVROLET: SILVERADO 1500 V8-5.3L 2003-1999, SILVERADO 1500 V8-4.8L 2000-1999, SILVERADO 1500 V6-4.3L 2004-1999, SILVERADO 1500 V8-6.0L 2003-1999, SILVERADO 1500 HD V8-6.0L 2003-2001, SILVERADO 2500 V8-5.3L 2000-1999, SILVERADO 2500 V8-6.0L 2003-1999, SILVERADO 2500 HD V8-8.1L 2003-2001, SILVERADO 2500 HD V8-6.0L 2003-2001, SILVERADO 3500 V8-8.1L 2003-2001, SILVERADO 3500 V8-6.0L 2003-2001, GMC: SIERRA 1500 V8-5.3L 2003-1999, SIERRA 1500 V8-4.8L 2003-1999, SIERRA 1500 V6-4.3L 2004-1999, SIERRA 1500 HD V8-6.0L 2003-2001, SIERRA 2500 V8-5.3L 2000-1999, SIERRA 2500 9 V8-6.0L 2003-1999 SIERRA 2500 HD V8-8.1L 2003-2001, SIERRA 2500 HD1 V8-6.0L 2003-2001, SIERRA 3500 V8-8.1L 2003-2001, SIERRA 3500 V8-6.0L 2003-2001; GMC: SIERRA DENALI



GCA205

FEATURES / CARACTERÍSTICAS: 12V 4.25BAR 150L/H

REPLACES / REEMPLAZA:

ACDELCO: MU1777, MU149; AIRTEX: E3972M; BOSCH: 67368; DELPHI: FG0089; GM: 19179597, 25314327; CARTER: P74770M

APPLICATION / APLICACIÓN:

CADILLAC: ESCALADE V8-5.7L 2000-1999;
CHEVROLET: TAHOE V8-5.7L 2000-1998;
GMC: YUKON V8-5.7L 1999-1998;
YUKON: DENALI V8-5.7L 2000-1999



GCA206

FEATURES / CARACTERÍSTICAS: 12V 4.25BAR 150L/H

REPLACES / REEMPLAZA:

ACDELCO: MU1614; AIRTEX: E3501M; GM: 19153712

APPLICATION / APLICACIÓN:

CHEVROLET: SILVERADO 1500 V8-5.3L 2003-1999, SILVERADO 1500 V8-4.8L 2003-1999, SILVERADO 1500 V6-4.3L 2003-1999, SILVERADO 1500 V8-6.0L 2003-1999, SILVERADO 2500 V8-5.3L 2000-1999, SILVERADO 2500 V8-6.0L 2003-1999, SILVERADO 2500 HD V8-8.1L 2003-2001, SILVERADO 2500 HD V8-6.0L 2003-2001, SILVERADO 3500 V8-8.1L 2003-2001, SILVERADO 3500 V8-6.0L 2003-2001; GMC: SIERRA 1500 V8-5.3L 2003-1999, SIERRA 1500 V8-4.8L 2003-1999, SIERRA 1500 V6-4.3L 2003-1999, SIERRA 2500 V8-5.3L 2000-1999 SIERRA 2500 V8-6.0L 2003-1999, SIERRA 2500 HD V8-8.1L 2003-2001, SIERRA 2500 HD V8-6.0L 2003-2001, SIERRA 3500 V8-8.1L 2003-2001, SIERRA 3500 V8-6.0L 2003-2001, SIERRA DENALI



GCA207

FEATURES / CARACTERÍSTICAS: 12V 4.25BAR 121L/H

REPLACES / REEMPLAZA:

ACDELCO: MU1733, MU85; AIRTEX: E3992M; GM: 19177220

APPLICATION / APLICACIÓN:

CHEVROLET: BLAZER V6-4.3L 2005-1998;
GMC: JIMMY V6-4.3L 2001-1998;
OLDSMOBILE: BRAVADA V6-4.3L 2001-1998



GCA208

FEATURES / CARACTERÍSTICAS: 12V 3.5BAR 73L/H

REPLACES / REEMPLAZA:

ACDELCO: MU1780, MU181; AIRTEX: E3950M; BOSCH: 67472; DELPHI: FG0115; GM: 19179627, 25317984; CARTER: P74781M

APPLICATION / APLICACIÓN:

CHEVROLET: CAVALIER L4-2.2L Fuel 2000-1999, CAVALIER L4-2.4L 1999, MALIBU V6-3.1L 1999-1998, MALIBU L4-2.4L 1999-1998;
OLDSMOBILE: ALERO V6-3.4L 1999, ALERO L4-2.4L 1999, CUTLASS V6-3.1L 1999-1998;
PONTIAC: GRAND AM V6-3.4L 1999, GRAND AM L4-2.4L 1999, SUNFIRE L4-2.4L 1999-1998, SUNFIRE L4-2.2L 2000-1999



GCA209

FEATURES / CARACTERÍSTICAS: ...

REPLACES / REEMPLAZA:

ACDELCO: MU1745, MU146; **AIRTEX:** E3947M; **BOSCH:** 67381; **DELPHI:** FG0086; **GM:** 19177226, 25314321; **CARTER:** P74757M

APPLICATION / APLICACIÓN:

CHEVROLET: C1500 V6-4.3L 1998-1997, C1500 V8-5.7L 1999-1998, C1500 V8-5.0L 1999-1998, C2500 V8-7.4L 2000-1998, C2500 V8-5.7L 2000-1998, C2500 V8-5.0L 1998, C3500 V8-7.4L 2000-1998, C3500 8 V8-5.7L 2000-1998, K1500 7 V6-4.3L 1998-1997, K1500 V8-5.7L 1999-1998, K1500 V8-5.0L 1999-1998, K2500 V8-7.4L 2000-1998, K2500 V8-5.7L 2000-1998, K2500 V8-5.0L 1998, K3500 V8-7.4L 2000-1998, K3500 V8-5.7L 2000-1998;

GMC: C1500 V6-4.3L 1998-1997, C1500 V8-5.0L 1999-1998, C2500 V8-5.7L 1998, C2500 V8-5.0L 1998, K1500 V6-4.3L 1998-1997, K1500 V8-5.7L 1999-1998, K1500 V8-5.0L 1999-1998, K2500 8 V8-7.4L 2000-1998, K2500 V8-5.7L 2000-1998, K2500 V8-5.0L 1998, K3500 V8-7.4L 2000-1998, K3500 V8-5.7L 2000-1998



GCA210

FEATURES / CARACTERÍSTICAS: 12V 3.7BAR 96L/H

REPLACES / REEMPLAZA:

ACDELCO: MU1806, MU1532, MU224; **AIRTEX:** E3372M; **DELPHI:** FG0148; **GM:** 19180118, 19122465, 25323823, E3372M; **CARTER:** P72794M; **PONTIAC:** E3372M; **OLDSMOBILE:** E3372M

APPLICATION / APLICACIÓN:

CHEVROLET: VENTURE V6-3.4L 2001-1998;

OLDSMOBILE: SILHOUETTE V6-3.4L 2001-1998;

PONTIAC: MONTANA V6-3.4L 2001-1999, VENTURE V6-3.4L 1998, TRANSPORT1998



GCA211

FEATURES / CARACTERÍSTICAS: ...

REPLACES / REEMPLAZA:

ACDELCO: MU145; **AIRTEX:** E3962M

APPLICATION / APLICACIÓN:

CHEVROLET: C2500 V8-7.4L 2000-1998, C2500 V8-5.7L 2000-1998, C3500 V8-7.4L 2000-1998, C3500 V8-5.7L 2000, K2500 V8-7.4L 2000-1998, K2500 V8-5.7L 2000-1998, K3500 V8-7.4L 2000-1998, K3500 V8-5.7L 2000-1998;

GMC: C2500 1998 V8-5.7L1998, K2500 00-98 V8-7.4L 2000-1998 GMC K2500 00-98 V8-5.7L 2000-1998, GMC K3500 00-98 V8-7.4L 2000-1998, GMC K3500 00-98 V8-5.7L 2000-1998



GCA212

FEATURES / CARACTERÍSTICAS: ...

REPLACES / REEMPLAZA:

ACDELCO: MU1751, MU1062, MU111; **AIRTEX:** E3952M; **BOSCH:** 67420; **DELPHI:** FG0070; **GM:** 19177238, 19122465, 25344814, 25323823; **CARTER:** P75006M

APPLICATION / APLICACIÓN:

CHEVROLET: S10 V6-4.3L 2002-1997;

GMC: SONOMA V6-4.3L 2002-1997;

ISUZU: HOMBRE 7 V6-4.3L 2000-1997



GCA213

FEATURES / CARACTERÍSTICAS: ...

REPLACES / REEMPLAZA:

ACDELCO: MU227; **AIRTEX:** E3973M; **BOSCH:** 67369; **DELPHI:** FG0151; **GM:** 25177108, 25323831; **CARTER:** P74792M

APPLICATION / APLICACIÓN:

BUICK: REGAL V6-3.8L 1999-1998;

PONTIAC: GRAND PRIX V6-3.8L 2000-1998



GCA214

FEATURES / CARACTERÍSTICAS: ...

REPLACES / REEMPLAZA:

ACDELCO: MU109, MU1782; **AIRTEX:** E3940M; **BOSCH:** 67072; **DELPHI:** FG0068; **GM:** 19180091, 25178736; **CARTER:** P74752M

APPLICATION / APLICACIÓN:

CHEVROLET: ASTRO V6-4.3L 1999-1997;

GMC: SAFARI V6-4.3L 1999-1997



GCA215

FEATURES / CARACTERÍSTICAS: ...

REPLACES / REEMPLAZA:

ACDELCO: MU1755, MU1063, MU113; **AIRTEX:** E3954M; **BOSCH:** 67408; **DELPHI:** FG0072; **GM:** 19177256, 25344816, 25348146

APPLICATION / APLICACIÓN:

CHEVROLET: BLAZER V6-4.3L 2002-1997;

GMC: JIMMY V6-4.3L 2001-1997



GCA216

FEATURES / CARACTERÍSTICAS: ...

REPLACES / REEMPLAZA:

ACDELCO: MU170, MU1321, MU1518; **AIRTEX:** E3508M; **DELPHI:** FG0324; **GM:** 15205627, 19121628, 19122465, 25323823; **CARTER:** P74832M

APPLICATION / APLICACIÓN:

CADILLAC: ESCALADE V8-6.0L 2003-2002, ESCALADE V8-5.3L 2003-2002;

CHEVROLET: TAHOE V8-5.3L 2003-2000, TAHOE V8-4.8L 2003-2000 **GMC:** YUKON V8-5.3L 2003-2000, YUKON V8-4.8L 2003-2000, YUKON DENALI V8-6.0L 2003-2001



GCA217

FEATURES / CARACTERÍSTICAS: ...

REPLACES / REEMPLAZA:

ACDELCO: MU171, MU1443, MU1618; **AIRTEX:** E3509M; **BOSCH:** 67308; **DELPHI:** FG0105; **GM:** 15759666, 19153716, 25315983; **CARTER:** P74836M

APPLICATION / APLICACIÓN:

CHEVROLET: SUBURBAN 1500 V8-5.3L 2001-2000;

GMC: YUKON DENALI XL V 8-6.0L 2001, YUKON XL 1500 V8-5.3L 2001-2000



GCA218

FEATURES / CARACTERÍSTICAS: ...

REPLACES / REEMPLAZA:

ACDELCO: MU13; **AIRTEX:** E3925M; **GM:** 25163489

APPLICATION / APLICACIÓN:

CHEVROLET: BLAZER V6-4.3L 1996;

GMC: JIMMY V6-4.3L 1996;

OLDSMOBILE: BRAVADA V6-4.3L 1996



GCA219

FEATURES / CARACTERÍSTICAS: ...

REPLACES / REEMPLAZA:

ACDELCO: MU159, MU1818; **AIRTEX:** E3971M; **BOSCH:** 67367; **DELPHI:** FG0099; **GM:** 19179492, 25314352; **CARTER:** P74779M

APPLICATION / APLICACIÓN:

CHEVROLET: EXPRESS 1500 V8-5.7L 2002-1998, EXPRESS 1500 V8-5.0L 2002-1998, EXPRESS 1500 V6-4.3L 2002-1998, EXPRESS 2500 V8-5.7L 2002-1998, EXPRESS 2500 V8-5.0L 2002-1998, EXPRESS 2500 V6-4.3L 2002-1998, EXPRESS 3500 V8-7.4L 2000-1998, EXPRESS 3500 V8-8.1L 2002-2001, EXPRESS 3500 V8-5.7L 2002-1998;

GMC: SAVANA 1500 V8-5.7L 2002-1998, SAVANA 1500 V8-5.0L 2002-1998, SAVANA 1500 V6-4.3L 2002-1998, SAVANA 2500 V8-5.7L 2002-1998, SAVANA 2500 V8-5.0L 2002-1998, SAVANA 2500 V6-4.3L 2002-1998, SAVANA 3500 V8-7.4L 2000-1998, SAVANA 3500 V8-8.1L 2002-2001, SAVANA 3500 V8-5.7L 2002-1998



GCA220

FEATURES / CARACTERÍSTICAS: ...

REPLACES / REEMPLAZA:

ACDELCO: MU1727, MU232; **AIRTEX:** E3537M; **BOSCH:** 67319; **DELPHI:** FG0156; **GM:** 19180107, 25325702; **CARTER:** P74792M

APPLICATION / APLICACIÓN:

BUICK: CENTURY V6-3.1L 1999-1998, REGAL V6-3.8L 1999-1998, OLDSMOBILE: INTRIGUE V6-3.5L 2000-1999, INTRIGUE V6-3.8L, 1999-1998;

PONTIAC: GRAND PRIX V6-3.8L 2000-1998, GRAND PRIX V6-3.1L 2000-1998



GCA221

FEATURES / CARACTERÍSTICAS: ...

REPLACES / REEMPLAZA:

ACDELCO: MU1088; **AIRTEX:** E3556M; **GM:** 25345024

APPLICATION / APLICACIÓN:

CADILLAC: ESCALADE 2 V8-6.0L 2003-2002;

CHEVROLET: AVALANCHE 1500 V8-5.3L 2003-2002, SUBURBAN 1500 V8-5.3L 2003-2002;

GMC: YUKON DENALI XL V8-6.0L 2003-2002, YUKON XL 1500 V8-5.3L 2003-2002



GCA222

FEATURES / CARACTERÍSTICAS: ...

REPLACES / REEMPLAZA:

AIRTEX: E3976M; **DELPHI:** FG0146; **AC DELCO:** MU222; **GM:** 25323818

APPLICATION / APLICACIÓN:

CHEVROLET: VENTURE V6-3.4L 1997;

OLDSMOBILE: SILHOUETTE V6-3.4L 1997;

PONTIAC: TRANS SPORT V6-3.4L 1997



GCA224

FEATURES / CARACTERÍSTICAS: ...

REPLACES / REEMPLAZA:

AIRTEX: E3521M; **DELPHI:** FG0268; **AC DELCO:** MU1820, MU221; **GM:** 19169381, 25323787; **CARTER:** P74967M; **BOSCH:** 67388

APPLICATION / APLICACIÓN:

BUICK: RENDEZVOUS V6-3.4L 2004-2002;

PONTIAC: AZTEK V6-3.4L 2004-2001



GCA227

FEATURES / CARACTERÍSTICAS: ...

REPLACES / REEMPLAZA:

AIRTEX: E3507M; **AC DELCO:** MU1374, MU1253; **DELPHI:** FG0375

APPLICATION / APLICACIÓN:

CHEVROLET: CAVALIER L4-2.4L 2002-2001, CAVALIER L4-2.2L 2005-2000, CLASSIC L4-2.2L 2005-2004, MALIBU V6-3.1L 2003-2000, OLDSMOBILE: ALERO L4-2.4L 2001-2000, ALERO V6-3.4L 2004-2000, ALERO L4-2.2L 2004-2000;

PONTIAC: GRAND AM L4-2.4L 2001-2000, GRAND AM V6-3.4L 2005-2000, GRAND AM L4-2.2L 2005-2002, SUNFIRE L4-2.4L 2002-2000, SUNFIRE L4-2.2L 2005-2000



GCA228

FEATURES / CARACTERÍSTICAS: ...

REPLACES / REEMPLAZA:

AIRTEX: E3913M; **AC DELCO:** 43-911; **DELPHI:** FG0010

APPLICATION / APLICACIÓN:

CADILLAC: DEVILLE V8-4.9L 1995-1994, DEVILLE V8-4.6L 1996-1999, ELDORADO V8-4.6L 1996-1994, SEVILLE V8-4.6L 1996-1994



GCA229

FEATURES / CARACTERÍSTICAS: ...

REPLACES / REEMPLAZA:

AIRTEX: E7030M; **WALBRO:** TU100

APPLICATION / APLICACIÓN:

CHRYSLER: TOWN& COUNTRY V6-3.3L 1993-1991;

DODGE: CARAVAN V6-3.3L 1993-1991, CARAVAN V6-3.0L 1993-1991, CARAVAN L4-2.5L 1993-1991, GRAND CARAVAN V6-3.3L 1993-1991, GRAND CARAVAN V6-3.0L 1993-1992;

PLYMOUTH: GRAND VOYAGER V6-3.3L 1993-1991, GRAND VOYAGER V6-3.0L 1993-1992, VOYAGER V6-3.3L 1993-1991, VOYAGER V6-3.0L 1993-1991, VOYAGER L4-2.5L 1993-1991



GCA230

FEATURES / CARACTERÍSTICAS: ...

REPLACES / REEMPLAZA:

AIRTEX: E7075M; **AC DELCO:** MU2038, MU41; **BOSCH:** 67631; **CARTER:** P74676M; **DELPHI:** FG0201; **WALBRO:** TU106

APPLICATION / APLICACIÓN:

DODGE: NEON L4-2.0L 1996-1995;

PLYMOUTH: NEON L4-2.0L L4-2.0L 1996-1995



GCA232

FEATURES / CARACTERÍSTICAS: ...

REPLACES / REEMPLAZA:

AIRTEX: E7077M

APPLICATION / APLICACIÓN:

CHRYSLER: TOWN& COUNTRY V6-3.8L 1995-1994;

DODGE: CARAVAN V6-3.3L 1995-1994, CARAVAN V6-3.0L 1995-1994, CARAVAN L4-2.5L 1995-1994, GRAND CARAVAN V6-3.8L 1995-1994, GRAND CARAVAN V6-3.3L 1995-1994



GCA233

FEATURES / CARACTERÍSTICAS: ...

REPLACES / REEMPLAZA:

AIRTEX: E7089M; **AC DELCO:** MU2040, MU43; **BOSCH:** 67639; **CARTER:** P74693M; **DELPHI:** FG0203; **WALBRO:** TU111

APPLICATION / APLICACIÓN:

CHRYSLER: CIRRUS V6-2.5L 1997-1995, CIRRUS L4-2.4L 1997-1995, SEBRING V6-2.5L 1998-1996



GCA234

FEATURES / CARACTERÍSTICAS: ...

REPLACES / REEMPLAZA:

AIRTEX: E7113M; **BOSCH:** 67653; **CARTER:** P74802M; **DELPHI:** FG0228; **WALBRO:** TU144

APPLICATION / APLICACIÓN:

CHRYSLER: CIRRUS V6-2.5L 2000-1998, CIRRUS L4-2.4L 2000, CIRRUS L4-2.0L 2000



GCA235

FEATURES / CARACTERÍSTICAS: ...

REPLACES / REEMPLAZA:

AIRTEX: E3542M; **AC DELCO:** MU177, MU1176, MU1743; **CARTER:** P72928M, P74984M; **DELPHI:** FG0111, FG0342; **GM:** 25344933, 19177221, 25331861

APPLICATION / APLICACIÓN:

BUICK: CENTURY V6-3.1L 2005-2000, REGAL V6-3.8L 2004-2000;

CHEVROLET: IMPALA V6-3.8L 2005-2000, IMPALA V6-3.L 2005-2000



GCA238

FEATURES / CARACTERÍSTICAS: ...

REPLACES / REEMPLAZA:

AIRTEX: E3953M; **AC DELCO:** MU112; **BOSCH:** 67358; **CARTER:** P74789M; **DELPHI:** FG0071; **GM:** 25178731

APPLICATION / APLICACIÓN:

CHEVROLET: BLAZER V6-4.3L 1998-1997, JIMMY V6-4.3L 1998-1997, BRAVADA V6-4.3L 1998-1997



GCA239

FEATURES / CARACTERÍSTICAS: ...

REPLACES / REEMPLAZA:

AIRTEX: MU1274, 15129825; **CHEVROLET:** 15073337, 15748499

APPLICATION / APLICACIÓN:

CHEVROLET: S10 2.2L 00>02, S10 ZR5 2.2L 01>02, S10 PICKUP 00>02; **GMC:** Sonoma SL 2.2L 00>02



GCA260

FEATURES / CARACTERÍSTICAS: ...

REPLACES / REEMPLAZA:

AC DELCO: MU148, MU1746; **GM:** 19177227, 25314325, E3963M; **AIRTEX:** E3963M

APPLICATION / APLICACIÓN:

CHEVROLET: Tahoe 5.7L 98>99



GCA260B

FEATURES / CARACTERÍSTICAS: ...

REPLACES / REEMPLAZA:

AC DELCO: MU152, MU1748; **GM:** 25314341, E3967M, 19177231; **AIRTEX:** E3967M

APPLICATION / APLICACIÓN:

CHEVROLET: C1500 Suburban 5.7L 99, C2500 Suburban 7.4L 99, C1500 Suburban 5.7L 98; **GMC:** C1500 Suburban 5.7L 98, C2500 Suburban 7.4L 98, K1500 5.7L 98, K2500 Suburban 7.4L 98



GCA261

FEATURES / CARACTERÍSTICAS: ...

REPLACES / REEMPLAZA:

AC DELCO: MU1380, MU1375, MU1065, MU203; **GM:** 15036173, 25320538, 25344820, 25347149, 88965574, 88965569, E3506M; **AIRTEX:** E3506M; **GMC:** E3506M

APPLICATION / APLICACIÓN:

CHEVROLET: Astro 4.3L 00, Astro 4.3L 03; **GMC:** Safari 4.3L 00, Safari 4.3L 03



GCA301

FEATURES / CARACTERÍSTICAS: ...

REPLACES / REEMPLAZA:

AIRTEX: E7093M; **AC DELCO:** MU140; **BOSCH:** 67641; **CARTER:** P74710M; **WALBRO:** TU114; **DODGE:** E7093M

APPLICATION / APLICACIÓN:

DODGE: RAM 1500 Truck V6-3.9L 96>97, RAM 1500 PICKUP 1996-1997, RAM 2500 PICKUP 1996-1997, RAM 3500 PICKUP 1996-1997



GCA302

FEATURES / CARACTERÍSTICAS: ...

REPLACES / REEMPLAZA:

AIRTEX: E7138M; **AC DELCO:** MU2046; **WALBRO:** TU143, TU 139; **BOSCH:** 67717; **CARTER:** P74801M, P74735M, P74734M; **DODGE:** E7138M

APPLICATION / APLICACIÓN:

DODGE: RAM 1500 TRUCK V6-3.9L 01/98, RAM 2500 TRUCK V8-5.9L 02/98, RAM 3500 TRUCK V10-8.0L 02/98, RAM 1500 PICKUP 1998-2001, RAM 2500 PICKUP 1998-2002, RAM 3500 PICKUP 1998-2002



GCA303

FEATURES / CARACTERÍSTICAS: ...

REPLACES / REEMPLAZA:

AIRTEX: E7111M; **BOSCH:** 67652; **CARTER:** P74734M; **DELPHI:** FG0237; **WALBRO:** TU138

APPLICATION / APLICACIÓN:

DODGE: RAM 1500 TRUCK V8-5.2L 2001-1998, RAM 1500 TRUCK V6-3.9L 2001-1998, RAM 2500 TRUCK V8-5.9L 2002-1998, RAM 2500 TRUCK V10-8.0L 2002-1998, RAM 3500 TRUCK V8-5.9L 2002-1998, RAM 3500 TRUCK V10-8.0L 2002-1998



GCA304

FEATURES / CARACTERÍSTICAS: ...

REPLACES / REEMPLAZA:

AC DELCO: MU2049; **AIRTEX:** E7116M; **BOSCH:** 67656; **CARTER:** P74738M; **DELPHI:** FG0235

APPLICATION / APLICACIÓN:

DODGE: DAKOTA L4-2.5L 2002-1997, DAKOTA V8-4.7L 2003-2000, DAKOTA V6-3.9L 2003-1997, DAKOTA V8-5.9L 2003-1998, DAKOTA V8-5.2L 1999-1997



GCA305

FEATURES / CARACTERÍSTICAS: ...

REPLACES / REEMPLAZA:

AC DELCO: MU42; **AIRTEX:** E7086M; **BOSCH:** 67636; **CARTER:** P74695M, P74682M; **WALBRO:** TU107; **DODGE:** E7086M

APPLICATION / APLICACIÓN:

DODGE: RAM 1500 TRUCK V6-3.9L 95, RAM 2500 TRUCK V8-5.9L 95, RAM 3500 TRUCK V10-8.0L 95, RAM 1500 PICKUP 1995, RAM 2500 PICKUP 1995, RAM 3500 PICKUP 1995



GCA306

FEATURES / CARACTERÍSTICAS: ...

REPLACES / REEMPLAZA:

AC DELCO: MU81; **AIRTEX:** E7063M; **BOSCH:** 67621; **CARTER:** P74658M; **WALBRO:** TU125, GCA748

APPLICATION / APLICACIÓN:

DODGE: B150 V6-3.9L 92>94, B1500 V8-5.2L 95>96, B250 V6-3.9L 92>94, B2500 V8-5.9L 95>96, B350 V8-5.2L 92>94, B3500 V8-5.9L 95>96



GCA307

FEATURES / CARACTERÍSTICAS: ...

REPLACES / REEMPLAZA:

AC DELCO: PMU163; **AIRTEX:** E7062M; **BOSCH:** 67620; **CARTER:** P74675M; **WALBRO:** TU122; **DODGE:** E7062M

APPLICATION / APLICACIÓN:

DODGE: RAM 1500 TRUCK V6-3.9L 95, RAM 2500 TRUCK V8-5.9L 95, RAM 3500 TRUCK V10-8.0L 95, DAKOTA 1994-1995



GCA308

FEATURES / CARACTERÍSTICAS: ...

REPLACES / REEMPLAZA:

AC DELCO: MU3; **AIRTEX:** E7065M; **BOSCH:** 67616; **CARTER:** P74662M; **WALBRO:** TU105; **DODGE:** E7065M

APPLICATION / APLICACIÓN:

CHRYSLER: Concorde V6-3.3L 93>95, New Yorker V6-3.5L 94>95; **DODGE:** Intrepid V6-3.3L 93>95; RAM 1500 PICKUP 1994, RAM 2500 PICKUP 1994, RAM 3500 PICKUP 1994



GCA309

FEATURES / CARACTERÍSTICAS: ...

REPLACES / REEMPLAZA:

AC DELCO: MU2043; **AIRTEX:** E7101M; **BOSCH:** 67648; **CARTER:** P74707M; **WALBRO:** TU118

APPLICATION / APLICACIÓN:

CHRYSLER: Concorde V6-3.3L 96, New Yorker V6-3.5L 96; **DODGE:** Intrepid V6-3.3L 96>97; **EAGLE:** Vision V6-3.5L 96>97



GCA310

FEATURES / CARACTERÍSTICAS: ...

REPLACES / REEMPLAZA:

AC DELCO: MU2054; **AIRTEX:** E7117M; **BOSCH:** 67657; **CARTER:** P74803M; **DELPHI:** FG0238; **WALBRO:** TU140

APPLICATION / APLICACIÓN:

DODGE: DURANGO V8-5.2L 2000-1998, DURANGO V8-4.7L 2003-2000, DURANGO V8-5.9L 2003-1998, DURANGO V6-3.9L 1999-1998



GCA311

FEATURES / CARACTERÍSTICAS: ...

REPLACES / REEMPLAZA:

AIRTEX: E7161M; **BOSCH:** 67693; **CARTER:** P75028M; **DELPHI:** FG0423; **WALBRO:** TU151

APPLICATION / APLICACIÓN:

DODGE: RAM 1500 TRUCK V8-5.9L 2003-2002, RAM 1500 TRUCK V8-4.7L 2003-2002, RAM 1500 TRUCK V6-3.7L 2003-2002



GCA312

FEATURES / CARACTERÍSTICAS: ...

REPLACES / REEMPLAZA:

AC DELCO: MU76, EP419; **AIRTEX:** E7047M; **BOSCH:** 67612, 67611; **CARTER:** P74657M, P74655M; **WALBRO:** TU124, GCA749; **DODGE:** E7047M

APPLICATION / APLICACIÓN:

DODGE: D150 V6-3.9L 91>93, D250 V6-3.9L 91>93, RAM CHARGE V8-5.9L 91, W150 V6-3.9L 91>93, ED 150 PICKUP 1991-1993, ED 250 PICKUP 1991-1993, ED 350 PICKUP 1991-1993, RAM CHARGER 1991-1993, W150 PICKUP 1991-1993, W250 PICKUP 1991-1993, W350 PICKUP 1991-1993



GCA313

FEATURES / CARACTERÍSTICAS: ...

REPLACES / REEMPLAZA:

AC DELCO: MU3; **AIRTEX:** E7054M; **BOSCH:** 67616; **CARTER:** P74662M; **WALBRO:** TU105

APPLICATION / APLICACIÓN:

CHRYSLER: Concorde V6-3.3L 93>95, New Yorker V6-3.5L 94>95; **DODGE:** Intrepid V6-3.3L 93>95; **EAGLE:** Vision V6-3.5L 93>95



GCA314

FEATURES / CARACTERÍSTICAS: ...

REPLACES / REEMPLAZA:

AC DELCO: MU74; **AIRTEX:** E7050M; **BOSCH:** 67614; **CARTER:** P4654M; **WALBRO:** TU157

APPLICATION / APLICACIÓN:

DODGE: Dakota L4-2.5L 91>96



GCA315

FEATURES / CARACTERÍSTICAS: ...

REPLACES / REEMPLAZA:

AC DELCO: MU2050; **AIRTEX:** E7123M; **BOSCH:** 67689, 67660; **CARTER:** P74800M; **DELPHI:** FG0278; **WALBRO:** TU142; **DODGE:** E7123M

APPLICATION / APLICACIÓN:

DODGE: B1500 V6-3.9L 98, B3500 V8-5.9L 98, RAM 1500 VAN V6-3.9L 03/99, RAM 2500 VAN V8-5.9L 03/99, RAM 3500 VAN V8-5.2L 03/99, B1500 1998, B2500 1998, B3500 1998, RAM 1500 VAN 1999-2003, RAM 2500 VAN 1999-2003, RAM 3500 VAN 1999-2003



GCA316

FEATURES / CARACTERÍSTICAS: ...

REPLACES / REEMPLAZA:

AC DELCO: MU198; **AIRTEX:** E7099M; **BOSCH:** 67646; **CARTER:** P74708M; **WALBRO:** TU131

APPLICATION / APLICACIÓN:

JEEP: Grand Cherokee L6-4.6L 96



GCA318

FEATURES / CARACTERÍSTICAS: ...

REPLACES / REEMPLAZA:

19168894, FG0915-11B1; **CHEVROLET/PONTIAC:** E3726M

APPLICATION / APLICACIÓN:

CHEVROLET: COBALT2006-2008; **PONTIAC:** G5 2007-2008, PURSUIT 2006, SATURNION 2006-2007



GCA320

FEATURES / CARACTERÍSTICAS: ...

REPLACES / REEMPLAZA:

AIRTEX: E7103MN; **BOSCH:** 67649; **CARTER:** P75043M

APPLICATION / APLICACIÓN:

JEEP: Grand Cherokee L6-4.0L 97>98



GCA320B

FEATURES / CARACTERÍSTICAS: ...

REPLACES / REEMPLAZA:

AIRTEX: E7121MN; **BOSCH:** 67658; **CARTER:** P75040M; **WALBRO:** GCA733

APPLICATION / APLICACIÓN:

JEEP: Cherokee L4-2.5L 97>00



GCA320C

FEATURES / CARACTERÍSTICAS: ...

REPLACES / REEMPLAZA:

AIRTEX: E7127MN; **BOSCH:** 67662; **CARTER:** P05741M, P75039M

APPLICATION / APLICACIÓN:

JEEP: Grand Cherokee V8-4.7L 04/99



GCA320D

FEATURES / CARACTERÍSTICAS: ...

REPLACES / REEMPLAZA:

FG0918-11B1, F00HK0067; **JEEP:** 5012380AD

APPLICATION / APLICACIÓN:

JEEP: GRAND CHEROKEE 1999-2004



GCA320E

FEATURES / CARACTERÍSTICAS: ...

REPLACES / REEMPLAZA:

FG0916-11B1, 21015152; **SATURN:** E3951M

APPLICATION / APLICACIÓN:

SATURN: S COUPE 1998-2002, SL SEDAN 1998-2002, SW WAGON 1998-2001



GCA350

FEATURES / CARACTERÍSTICAS: ...

REPLACES / REEMPLAZA:

AC DELCO: EP2050H; **AIRTEX:** E2296S; **CARTER:** P74879S; **FORD MOTOR CO:** XL2Z-9H307AK, XL2Z-9H307AJ, XL2Z-9H307AA; **FORD MOTORCRAFT:** PFS-422, PFS-103

APPLICATION / APLICACIÓN:

FORD: EXPLORER V8-5.0L 99>01, EXPLORER V6-4.0L 99>01, EXPLORER SPORT TRAC V6-4.0L 01;

MERCURY: MOUNTAINEER V8-5.0L 99>01, MOUNTAINEER V6-4.0L 99>01



GCA351

FEATURES / CARACTERÍSTICAS: ...

REPLACES / REEMPLAZA:

AC DELCO: EP2065H; **AIRTEX:** E2266S; **BOSCH:** 67155; **CARTER:** P74805S; **FORD MOTOR CO:** P7PZ-9H307BE, P7PZ-9H307BD, P77Z-9H307BA; **FORD MOTOR CRAFT:** PFS-58

APPLICATION / APLICACIÓN:

FORD: EXPLORER V8-5.0L 97>98, EXPLORER V6-4.0L 97>98

MERCURY: MOUNTAINEER V6-4.0L 98, MOUNTAINEER V8-5.0L 87>98



GCA352

FEATURES / CARACTERÍSTICAS: ...

REPLACES / REEMPLAZA:

AIRTEX: E2181S; **FORD MOTOR CO:** F57Z-9H307JA, F57Z-9H307J

APPLICATION / APLICACIÓN:

FORD: EXPLORER V6-4.0L 95



GCA353B

FEATURES / CARACTERÍSTICAS: ...

REPLACES / REEMPLAZA:

AIRTEX: E3621S; **CARTER:** P80000S

APPLICATION / APLICACIÓN:

CHEVROLET: C1500 V6-4.3L 88>95, C2500 V8-7.4L 93, C3500 V8-5.7L 85>88, K1500 V6-4.3L 88>95, K2500 V8-7.4L 88>95, K3500 V8-5.7L 90>93;

CHEVROLET TRUCK: K1500 PICKUP 262 4.3L 88>93, K1500 PICKUP 305 5.0L, K2500 PICKUP 262 7.4L, K3500 PICKUP 305 5.0L; **GMC:** C1500 V6-4.3L 88>95, C2500 V8-7.4L 91>93, C3500 V8-5.7L 88>95, K1500 V6-4.3L 88>95, K2500 V8-7.4L 91>93, K3500 V8-5.7L 95>98, K3500 V8-7.4L 93>98; **GMC TRUCK:** C15/C1500 PICKUP 454 7.4L, C25/C2500 PICKUP 350 7.4L, C35/C3500 PICKUP 350 7.4L



GCA353C

FEATURES / CARACTERÍSTICAS: ...

REPLACES / REEMPLAZA:

AIRTEX: E3622S; **CARTER:** P80001S

APPLICATION / APLICACIÓN:

CHEVROLET: C1500 V6-4.3L 96, K1500 6-4.3L 96, K1500 PICKUP 262 4.3L 96; **CHEVROLET TRUCK:** K1500 PICKUP 305 5.0L 96>97, K2500 PICKUP 2350 5.7L 96>97, K3500 PICKUP 454 7.4L 96>97; **GMC:** C1500 V6-4.3L 96, C2500 V8-5.0L 96>97, C3500 V8-5.7L 96>97, C3500 V8-7.4L 96>97, K1500 V6-4.3L 96, K2500 V8-5.7L 96>97; **GMC TRUCK:** C15/C1500 PICKUP 262 4.3L 96, C25/C2500 PICKUP 454 7.4L 96>97, C35/C3500 PICKUP 5.7L 96>97



GCA354

FEATURES / CARACTERÍSTICAS: ...

REPLACES / REEMPLAZA:

AC DELCO: EP2011H; **AIRTEX:** E2078S; **BOSCH:** 67010; **FORD MOTOR CO:** P57Z-9H307EA, P57Z-9H307E, P17Z-9H307D, E97Z-9H307B; **MAZDA:** ZZM4-13-350A, ZZM4-13-350

APPLICATION / APLICACIÓN:

FORD: Ranger V6-4.0L 90>97; **MAZDA:** B2300 L4-2.3L 94>97, B3000 V6-3.0L 97



GCA354B

FEATURES / CARACTERÍSTICAS: ...

REPLACES / REEMPLAZA:

AC DELCO: EP2117H; **AIRTEX:** E2098S; **BOSCH:** 67029; **CARTER:** P74651S, P74645S; **FORD MOTOR CO:** F6SZ-9H307AB, F5SZ-9H307C, F4SZ-9H307D, F3SZ-9H307B, F2SZ-9H307A, F1SZ-9H307A, F0SZ-9H307A, E9SZ-9H307A; **FORD MOTOR CRAFT:** PFS-185, PFS-184, PFS-178, PFS-177, PFB-73

APPLICATION / APLICACIÓN:

FORD: Thunderbird V6-3.8L 89>97; **MERCURY:** Cougar V6-3.8L 89>97, Cougar V8-4.6L 94>97, Cougar V8-5.0L 91>93



GCA354C

FEATURES / CARACTERÍSTICAS: ...

REPLACES / REEMPLAZA:

AC DELCO: EP2009H; **AIRTEX:** E2144S; **BOSCH:** 67346; **CRAFT:** P74611S; **FORD MOTOR CO:** F2TZ-9H307LA, F2TZ-9H307L, F1TZ-9H307B; **FORD MOTOR CRAFT:** PFS-29

APPLICATION / APLICACIÓN:

FORD: Explorer V6-4.0L 91>94



GCA354D

FEATURES / CARACTERÍSTICAS: ...

REPLACES / REEMPLAZA:

AC DELCO: EP2010H; **AIRTEX:** E2106S; **BOSCH:** 67037; **FORD MOTOR CO:** F57Z-9H307FA, F57Z-9H307F, F0TZ-9H307L; **FORD MOTOR CRAFT:** PFS-38; **MAZDA:** ZZM5-13-350A, ZZM5-13-350

APPLICATION / APLICACIÓN:

FORD: Ranger L4-2.3L 90>97; **MAZDA:** B2300 L4-2.3L 94>97



GCA354E

FEATURES / CARACTERÍSTICAS: ...

REPLACES / REEMPLAZA:

AC DELCO: EP2066H; **AIRTEX:** E2103S; **BOSCH:** 67034; **CARTER:** P74518S; **FORD MOTOR CO:** E7TZ-9H307CA, E7TZ-9H307A, E7TZ-9H307BA, E7TZ-9H307B; **FORD MOTOR CRAFT:** PFS-141, PFS-139

APPLICATION / APLICACIÓN:

FORD: F-Super Duty V8-7.5L 88>89, F-150 V8-5.8L 88>89, F-250 V8-7.5L 87>89, F-350 V6-4.9L 87>89; **FORD TRUCK:** F250/350/450/550 Super Duty Pickup 460 7.5L 88>89



GCA355

FEATURES / CARACTERÍSTICAS: ...

REPLACES / REEMPLAZA:

FG0901-12B1, 1009231, 1017455, 1027981; **FORD:** 1009230

APPLICATION / APLICACIÓN:

FORD: ESCORT 1992-1995, COURIER 1996



GCA356

FEATURES / CARACTERÍSTICAS: ...

REPLACES / REEMPLAZA:

FORD: E2276S, 2C2Z9H307FA

APPLICATION / APLICACIÓN:

LADA: 2107 82>02/12; **FORD:** E-150 2000-2003, E-250 2000-2003, E-350 2000-2003, E-450 2000-2003, E-550 2002-2003



GCA357

FEATURES / CARACTERÍSTICAS: ...

REPLACES / REEMPLAZA:

AC DELCO: EP2055, EP2054, EP2052, EP2051; **AIRTEX:** E2237S; **BOSCH:** 67240, 67234, 67232, 67230, 67135; **CARTER:** P74880M; **FORD MOTOR CO:** XL3Z-9H307EB, XL3Z-9H307EA, XL3Z-9H307DB, XL3Z-9H307DA, XL3Z-9H307BB, XL3Z-9H307BA, XL3Z-9H307AB, XL3Z-9H307AA; **FORD MOTOR CRAFT:** PFS-108, PFS-107, PFS-105, PFS-108A

APPLICATION / APLICACIÓN:

FORD: F-150 V8-5.4L 03/99, F-150 Heritage V6-4.2L 04, F-250 V8-4.6L 99



GCA501

FEATURES / CARACTERÍSTICAS: ...

REPLACES / REEMPLAZA:

AIRTEX: E8656M, E8641M; **BOSCH:** 69847, 69804, 69803; **CARTER:** P76374M, P76323M; **HONDA:** 17045-SDA-A00, 17045-SEC-A00, 17045-SDA-A30; **SPECTRA:** SP8002M

APPLICATION / APLICACIÓN:

HONDA: Accord L4-2.4L 03>07; **ACURA:** TSX L4-2.4L 04>08



GCA501A

FEATURES / CARACTERÍSTICAS: ...

REPLACES / REEMPLAZA:

AIRTEX: E8567M, E8693M; **BOSCH:** 69800, 69849, 69852; **CARTER:** P76380M, P76410M; **HONDA:** 17045-S3V-A50, 17045-SDB-A30, 17045-SJC-A00; **SPECTRA:** SP8003M

APPLICATION / APLICACIÓN:

HONDA: Accord V6-3.5L 03>07, Riggeline V6-3.5L 06>11; **ACURA:** MDX V6-3.5L 03>05



GCA501B

FEATURES / CARACTERÍSTICAS: ...

REPLACES / REEMPLAZA:

AIRTEX: E8657M; **CARTER:** P76306M; **HONDA:** 17045-S9V-A00; **SPECTRA:** SP8022M

APPLICATION / APLICACIÓN:

HONDA: Pilot V6-3.5L 06; **ACURA:** MDX V6-3.5L 05>08



GCA501C

FEATURES / CARACTERÍSTICAS: ...

REPLACES / REEMPLAZA:

SPECTRA: SP8004M

APPLICATION / APLICACIÓN:

HONDA: Accord V6-3.0L 05



GCA501D

FEATURES / CARACTERÍSTICAS: ...

REPLACES / REEMPLAZA:

AIRTEX: E8654M; **DELPHI:** FG0960; **SPECTRA:** SP8033M

APPLICATION / APLICACIÓN:

HONDA: Element L4-2.4L 03>11



GCA501E

FEATURES / CARACTERÍSTICAS: ...

REPLACES / REEMPLAZA:

AIRTEX: E8717M; **SPECTRA:** SP8039M

APPLICATION / APLICACIÓN:

HONDA: Ridgeline 6V-3.5L 06>12



GCA501F

FEATURES / CARACTERÍSTICAS: ...

REPLACES / REEMPLAZA:

AIRTEX: E8640M; **SPECTRA:** SP8041M; **ACURA:** E8640M

APPLICATION / APLICACIÓN:

HONDA: Acura MDX 6V-3.5L 05>06



GCA502

FEATURES / CARACTERÍSTICAS: ...

REPLACES / REEMPLAZA:

SPECTRA: SP8922M

APPLICATION / APLICACIÓN:

ACURA: TSX L4-2.4L 09>10; **HONDA:** Accord L4-2.4L 08>12



GCA502A

FEATURES / CARACTERÍSTICAS: ...

REPLACES / REEMPLAZA:

AIRTEX: E8923M; **SPECTRA:** SP8006M

APPLICATION / APLICACIÓN:

HONDA: Accord V6-3.5L 08>09



GCA502B

FEATURES / CARACTERÍSTICAS: ...

REPLACES / REEMPLAZA:

AIRTEX: E8792M; **SPECTRA:** SP8023M

APPLICATION / APLICACIÓN:

HONDA: Pilot V6-3.5L 09>11



GCA502C

FEATURES / CARACTERÍSTICAS: ...

REPLACES / REEMPLAZA:

SPECTRA: SP8025M

APPLICATION / APLICACIÓN:

HONDA: CR-V L4-2.4L 07>11



GCA503

FEATURES / CARACTERÍSTICAS: ...

REPLACES / REEMPLAZA:

AIRTEX: E8642M; **SPECTRA:** SP8019M; **HONDA:** 17045-S0X-A32, 17045-S0X-A02

APPLICATION / APLICACIÓN:

HONDA: Odyssey V6-3.5L 99>04



GCA503A

FEATURES / CARACTERÍSTICAS: ...

REPLACES / REEMPLAZA:

AIRTEX: E7151M; **BOSCH:** 67986, 67981; **SPECTRA:** SP7038M

APPLICATION / APLICACIÓN:

CHRYSLER: Sebring L4-2.4L 01, Sebring V6-3.6L 01; **DODGE:** Stratus L4-2.4L 01; **MITSUBISHI:** Eclipse L4-2.4L 00>01, Galant V6-3.6L 99>00



GCA503B

FEATURES / CARACTERÍSTICAS: ...

REPLACES / REEMPLAZA:

AIRTEX: E8720M; **SPECTRA:** SP8021M

APPLICATION / APLICACIÓN:

HONDA: Patriot V6-3.5L 03>04



GCA504

FEATURES / CARACTERÍSTICAS: ...

REPLACES / REEMPLAZA:

AIRTEX: E8655M, E733M; **BOSCH:** 67950; **CARTER:** P76354M; **HONDA:** 17045-S9A-A30; **SPECTRA:** SP8024M, SP8037M

APPLICATION / APLICACIÓN:

HONDA: CR-V L4-2.4L 05>06



GCA505

FEATURES / CARACTERÍSTICAS: ...

REPLACES / REEMPLAZA:

AIRTEX: E8723M; **CARTER:** P76375M

APPLICATION / APLICACIÓN:

HONDA



GCA505A

FEATURES / CARACTERÍSTICAS: ...
 REPLACES / REEMPLAZA:
CARTER: P76375M; **HONDA:** E8836M, 17045SNCL00
 APPLICATION / APLICACIÓN:
HONDA: CIVIC 2006-2011



GCA505B

FEATURES / CARACTERÍSTICAS: ...
 REPLACES / REEMPLAZA:
CARTER: P76378M
 APPLICATION / APLICACIÓN:
HONDA



GCA508

FEATURES / CARACTERÍSTICAS: ...
 REPLACES / REEMPLAZA:
BOSCH: 69962, 69961; **HONDA:** 17045-S5A-A31, 17045-S5A-A30, 17045-S5A-A00
 APPLICATION / APLICACIÓN:
HONDA: CIVIC L4-1.3L 03>05



GCA508A

FEATURES / CARACTERÍSTICAS: ...
 REPLACES / REEMPLAZA:
AIRTEX: E8566M; **SPECTRA:** SP8011M
 APPLICATION / APLICACIÓN:
HONDA: CIVIC L4-1.7L/2.0L 02>05



GCA509

FEATURES / CARACTERÍSTICAS: ...
 REPLACES / REEMPLAZA:
AIRTEX: E2097M
 APPLICATION / APLICACIÓN:
FORD: Fusion L4-2.5L 10; **MERCURY:** Milan L4-2.5L 10



GCA509A

FEATURES / CARACTERÍSTICAS: ...
 REPLACES / REEMPLAZA:
AIRTEX: E2458M; **SPECTRA:** SP2380M
 APPLICATION / APLICACIÓN:
FORD: Fusion V6-3.0L 06; **LINCOLN:** ZEPYN V6-3.0L 06; **MERCURY:** Milan V6-3.0L 06



GCA509B

FEATURES / CARACTERÍSTICAS: ...
 REPLACES / REEMPLAZA:
AIRTEX: E2459M; **SPECTRA:** SP2367M
 APPLICATION / APLICACIÓN:
FORD: Fusion L4-2.3L 06>09; **MERCURY:** Milan L4-2.3L 06>09



GCA509C

FEATURES / CARACTERÍSTICAS: ...
 REPLACES / REEMPLAZA:
AIRTEX: E7220M; **CARTER:** P76268M; **SPECTRA:** SP7040M
 APPLICATION / APLICACIÓN:
DODGE: Caliber L4-1.8L/2.0L/2.4L 07>11; **JEEP:** Patriot L4-2.0L/2.4L 07>13; Compass L4-2.0L/2.4L 07>13



GCA509D

FEATURES / CARACTERÍSTICAS: ...

REPLACES / REEMPLAZA:

AIRTEX: E7218M; **CARTER:** P76269M; **SPECTRA:** SP7020M

APPLICATION / APLICACIÓN:

DODGE: Caliber L4-2.4 07>08; **JEEP:** Patriot L4-2.4L 07>11; Compass L4-2.4L 07>11



GCA509E

FEATURES / CARACTERÍSTICAS: ...

REPLACES / REEMPLAZA:

AIRTEX: E2474M; **SPECTRA:** SP2120M; **FORD/LINCOLN/MERCURY:** E2474M

APPLICATION / APLICACIÓN:

FORD: Fusion 6V-3.0L 07>09, Lincoln 6V-3.5L 07>09, Mercury Milan 6V-3.0L 07>09



GCA511A

FEATURES / CARACTERÍSTICAS: ...

REPLACES / REEMPLAZA:

AIRTEX: E2470M

APPLICATION / APLICACIÓN:

FORD

GCA15001 // NEW //

FEATURES / CARACTERÍSTICAS: ...

REPLACES / REEMPLAZA:

SAAB: 30587077, 5196423; **MEAT & DORIA:** 77301

APPLICATION / APLICACIÓN:

SAAB: 9-5 Saloon/Estate 2.0/2.3/3.0 1997>2009

GCA150A01 // NEW //

FEATURES / CARACTERÍSTICAS: ...

REPLACES / REEMPLAZA:

SAAB: 5328679; **MEAT & DORIA:** 77300

APPLICATION / APLICACIÓN:

SAAB: 9000 Hatch/Saloon 2.0/2.3/3.0 1988>1998

GCA150B01 // NEW //

FEATURES / CARACTERÍSTICAS: ...

REPLACES / REEMPLAZA:

SAAB: 5328885; **MEAT & DORIA:** 77299

APPLICATION / APLICACIÓN:

SAAB: 900 Mk2 Hatch 2.0/2.3/2.5 1993>1998, 900 Mk2 Saloon 2.0 1993>1998

GCA150C01 // NEW //

FEATURES / CARACTERÍSTICAS: ...

REPLACES / REEMPLAZA:

SAAB: 30587015, 4023867, 5196415, 8822785; **MEAT & DORIA:** 76989

APPLICATION / APLICACIÓN:

SAAB: 9-3 Saloon/9-3 Cabrio/9-3 Estate 2002>2015, 900 Mk2 Hatch/900 Mk2 Coupe/900 Mk2 Cabrio 1993>1998



EMS COMPONENTS | SISTEMA DE CONTROL DE MOTOR

FUEL INJECTOR | INYECTOR DE COMBUSTIBLE



GI9000 // NEW //

REPLACES / REEMPLAZA:

Kia/Hyundai: 35310-3C000

APPLICATION / APLICACIÓN:

Hyundai: Sonata 3.3 DOHC V6 2006>2010, Veracruz 3.8 DOHC V6 2007>2012, Santa Fé 3.3 DOHC V6 2008>2009, Azera 3.3/3.8 DOHC V6 2008>2011, Genesis 3.8 2009, Entourage 3.8 2007>2008

Kia: Sorento 3.3/3.8 DOHC V6 2008>2009, Sedona 3.8 2006>2010, Amanti 3.8 2007>2009



GI9001

REPLACES / REEMPLAZA:

IWP 001; Magneti Marelli: 501 011 02;

Fiat: 71 719 037

APPLICATION / APLICACIÓN:

FIAT: Brava 1.6 16V 00>01; Palio, Siena, Weekend 1.6 16V 96>99



GI9002

FEATURES / CARACTERÍSTICAS:

Similar GI9357 (Bosch model)

REPLACES / REEMPLAZA:

Sagem: 01F002A

Citroën/Peugeot: 1984 E0

Bosch: 0 280 156 357

APPLICATION / APLICACIÓN:

CITROËN: Berlingo MultiSpace 1.4 1996>2008, Berlingo Van 1.4 1996>, C2 1.4 2003>, C3 1.4 2002>, C3 Pluriel 2003>, Saxo hatch 1.4 1996>2004, Xsara hatch 1.4 1997>2005, Xsara Estate 1.4 1997>2010, Xsara Coupe 1.4 1998>2005

PEUGEOT: 106 MK 2 hatch 1.4 1996>, 206 hatch 1.4 1998>, 206 Saloon 1.4 2007>, 206 SW Estate 1.4 2002>, 306 Sallón 1.4 SL 1993>2003, 306 Estate 1.4 1994>2002, 307 hatch 1.4 2000>, 307 Estate 1.4 2002>, 307 SW Estate 1.4 2002>, 1007 1.4 2005>, Partner MK1 MPV 1.4 1996>, Partner MK1 Van 1.4 1996>



GI9003

FEATURES / CARACTERÍSTICAS:

Multipoint System

REPLACES / REEMPLAZA:

IWP 003

APPLICATION / APLICACIÓN:

FIAT: Palio (Fire Flex) 1.4 8V (MPI) All, Siena 1.4 8V (MPI - Flex / TetraFuel) All, Strada 1.4 8V (MPI - Flex) All



GI9005

REPLACES / REEMPLAZA:

IWP 005; Magneti Marelli: 501.046.02

APPLICATION / APLICACIÓN:

Fiat: Linea 1.9 16V Flex

Mitsubishi: Pajero TR4, Pajero V6



GI9006

FEATURES / CARACTERÍSTICAS:

Multipoint System

REPLACES / REEMPLAZA:

IWP 006

APPLICATION / APLICACIÓN:

FIAT: Brava (HGT), Marea 1.8 16V (gasoline) All



GI9007

REPLACES / REEMPLAZA:

Kia: 9625587580

Magneti Marelli: IPM002

Citroën/Peugeot: 1984C9

APPLICATION / APLICACIÓN:

KIA: Pride

CITROËN: Berlingo MultiSpace Mk1 1.1 1996>2008, C2 1.1 2003>, C3 1.1 2002>

PEUGEOT: 206 hatch 1.1 1998>2000, 206 SW estate 1.1 2002>, Partner Mk1 1.1 1996>2002



GI9014

REPLACES / REEMPLAZA:

Bosch: 0 280 156 014

Mercedes Benz: 1120780149

APPLICATION / APLICACIÓN:

MERCEDES BENZ: C-Class Estate: C 240 T 2000>2001 / C-Class Sallón: C 240, C 240 4-matic, C 320, C 320 4-matic, C 350, C 350 4-matic 2000>2007 / C-Class Saloon: C 240, C 240 4-matic, C 320, C320 4-matic, C 350, C 350 4-matic 2000>2007 / C-Class Estate: C 240, C 240 4-matic, C 320, C 320 4-matic, C 350, C 350 4-matic 2001>2007 / C-Class Coupe: C 320, C 350 2002>2008 / CLK-Class: 320 1997>2002 / CLK-Class Convertible: 320 1998>2002 / CLK-Class: 240, 320 2002>2009 / E-Class Saloon: E 240, E 280, E 280 4-matic, E 320, E 320 4-matic 1996>2002 / E-Class Estate E 240 T, E 280 T, E 280 T 4-matic, E 320 T, E 320 T 4-matic 1996>2003 / S-Class Sallón: S 280, S320 1998>2005 / SLK-Class: 320 2000>2004 / M-Class: ML 320 1998>2002 / G-Class Cabrio: G 320 1997> / Viano: 3.0, 3.2 2003> / Vito Van/Minibus: 119, 122 2003>



GI9018

REPLACES / REEMPLAZA:

Magneti Marelli: IPM018

APPLICATION / APLICACIÓN:

KIA: Pride



GI9020

REPLACES / REEMPLAZA:

Bosch: 0 280 156 020

Fiat: 7082242

APPLICATION / APLICACIÓN:

FIAT: Doblo 1.3 MPI 16V 2001>2006, Palio 1.0/1.3 MPI 16V 2000>2003, Palio Weekend 1.0/1.3 MPI 16V 2000>2003, Siena 1.0/1.3 MPI 16V 2000>2003



GI9024

REPLACES / REEMPLAZA:

IWP 024; Magneti Marelli: 501 007 02;
VW: 026 998 031 2

APPLICATION / APLICACIÓN:

VW: Gol, Parati, Saveiro 1.6/1.8 (MPI - alcohol) 97>;
Gol, Parati, Quantum, Santana, Saveiro 2.0 (MPI - gasoline)
Quantum, Santana 1.8 (MPI - alcohol) 97>



GI9026

REPLACES / REEMPLAZA:

IWP 026; Magneti Marelli: 501 526 02

APPLICATION / APLICACIÓN:

Renault: Scénic 1.6 16V, Mégane 1.6 16V;
Seat: Ibiza 1.0 2000;
VW: Golf 1.0 16V MPI 97>00, Parati 1.0 16V 97>00, Polo 1.0 16V 2001;
Fiat: Palio, Siena, Weekend, Strada 1.6 16V



GI9034

REPLACES / REEMPLAZA:

Bosch: 0 280 156 034

Citroën/Peugeot: 1984 E9

APPLICATION / APLICACIÓN:

CITROËN: Berlingo Multi Space 1.6 16V 2000, Berlingo Van MK 1.6 16V 2000, C2 1.6 2003, C3 1.6 16V 2002, C3 pluriel 1.6 2003, Xsara hatch 1.6 16V 00>05, Xsara Estate 1.6 16V 00>05, Xsara Coupe 1.6 16V 00>05

PEUGEOT: 206 hatch 1.6 16v 2000->, 206 SW estate 1.6 16v 2002->, 206 CC convertible 1.6 16v 2000->, 307 hatch 1.6 16v 2000->, 307 estate 1.6 16v 2002->, 307 SW estate 1.6 16v 2002->, 1007 1.6 16v 2005->, Partner Mk1 Mpv 1.6 16v 2001>2008



GI9038

REPLACES / REEMPLAZA:

Bosch: 0 280 156 038

Alfa Romeo: 60665644

APPLICATION / APLICACIÓN:

ALFA ROMEO: 147 hatch 3.2 2003>2010, 156 Saloon 3.2 2002>2005, 156 Estate 3.2 2002>2006, 166 Saloon 3.0 V6 24V 2000>2007, 166 Saloon 3.2 V6 24V 2003>2007, GT 3.2 2003>2010, GTV Coupe 3.0 V6 24V 2000>2005, 3.2 V6 2003>2005, Spider 3.0 V6 1994>2005, Spider 3.2 V6 24V 2003>2005

LANCIA: Thesis 3.0 V6, 3.2 V6 2002>2009



GI9039

REPLACES / REEMPLAZA:

IWP 039

Fiat: 55209826

APPLICATION / APLICACIÓN:

FIAT: Linea 1.8 / 1.9 16V Flex



GI9040

REPLACES / REEMPLAZA:

Denso: 23250-22040

APPLICATION / APLICACIÓN:

Toyota: Avensis MK1 saloon/hatch/estate 1.8 2000>2003, Avensis MK2 hatch/saloon/estate 1.8 2003>2008, Celica coupe 1.8 16V 1999>2005, Corolla verso MK1 1.8 2001>2004, MR2 MK3 roadster 1.8 16V 1999>2007



GI9041

REPLACES / REEMPLAZA:

IWP 041; Magneti Marelli: 501 009 02;

VW: 036 998031 1

APPLICATION / APLICACIÓN:

SEAT: Ibiza 1.0 16V 00> VW: Gol, Parati AT 1.0 16V (gasoline) 97>00, Polo Classic 1.0 16V (gasoline) 01>



GI9042

FEATURES / CARACTERÍSTICAS:

Multipoint System

REPLACES / REEMPLAZA:

IWP 042

APPLICATION / APLICACIÓN:

RENAULT: Clio II, Kangoo 1.6 16V (Hi-Flex) 99>, Laguna, Mégane, Scénic 1.6/2.0 16V (Hi-Flex), Partner 1.8/2.0 16V (Hi-Flex)



GI9043

REPLACES / REEMPLAZA:

IWP 043; Magneti Marelli: 501 010 02

APPLICATION / APLICACIÓN:

VW: Gol, Parati, Quantum, Santana, Saveiro 2.0 (MPI - alcohol) 97>



GI9044

REPLACES / REEMPLAZA:

IWP 044; Magneti Marelli: 501 008 02;

VW: 027 998 031.1

APPLICATION / APLICACIÓN:

SEAT: Caddy, Inca 1.6 (MPI - gasoline) 98>;
VW: Gol, Parati, Saveiro 1.6/1.8 (Mi - gasoline) 97>, Polo Classic 1.8 (Mi) 96>, Quantum, Santana 1.8 (MPI - gasoline) 96>, Van 1.6 (MPI - gasoline) 98>



G19046

FEATURES / CARACTERÍSTICAS:
 Multipoint System
REPLACES / REEMPLAZA:
IWP 046
APPLICATION / APLICACIÓN:
FIAT: Palio, Idea 1.4 (MPI - alcohol/gasoline) All



G19047

REPLACES / REEMPLAZA:
IWP047
APPLICATION / APLICACIÓN:
VW: Polo 1.0 16V Power



G19049

REPLACES / REEMPLAZA:
IWP 049; Magneti Marelli: 501.549.02
Citroën/Peugeot: 9624721880, 1984C8
APPLICATION / APLICACIÓN:
FIAT: Palio, Idea 1.4 (MPI - alcohol/gasoline) All



G19052

FEATURES / CARACTERÍSTICAS:
 Multipoint System
REPLACES / REEMPLAZA:
IWP 052
APPLICATION / APLICACIÓN:
FIAT: Palio, Uno Mille 1.0 8V (Economy Flex) 08>



G19057 // NEW //

FEATURES / CARACTERÍSTICAS:
 ...
REPLACES / REEMPLAZA:
BOSCH: 0 280 158 057; **CITROËN/PEUGEOT:**
 1984 F7, 96 495 26780; **MEAT & DORIA:** 75116057
APPLICATION / APLICACIÓN:
CITROËN: Berlingo First Furgão 1.6 16V 2000>2008, Berlingo First Monovolume 1.6 16V 2000>2011, Berlingo Furgão 1.6 2008>, Berlingo Multispace 1.6 2008>, C2 1.6 2003>2010, C3 Pluriel 1.6 2003>, C4 Coupé 1.6 16V 2004>2011, C4 I 1.6 16V 2004>2011, C4 I Sedan 1.6 16V 2006>2011, Xsara Picasso 1.6 16V 2005>2011;
PEUGEOT: 1007 1.6 16V 2005>, 206 Cc 1.6 16V 2000>2007, 206 Hatch 1.6 16V 2000>2009, 206 Sw 1.6 16V 2002>, 206 Sedan 1.6 16V 2007>, 207/207+ 1.6 16V 2006>2013, 307 1.6 16V 2000>2007, 307 Break 1.6 16V 2002>2008, 307 Cc 1.6 16V 2003>2009, 307 Sw 1.6 16V 2002>2008, 307 Sw 2.0 16V 2002>2005, 308 I 1.6 Bioflex 2008>2014, Partner Furgão 1.6 2008>, Partner Tepee 1.6 Vti 2008>



G19058

REPLACES / REEMPLAZA:
IWP 058; Magneti Marelli: 501 022 02
APPLICATION / APLICACIÓN:
VW: Gol 1.0 8V (MPI - gasoline) 03>



G19061

REPLACES / REEMPLAZA:
Bosch: 0 280 156 061
Audi/ VW: 06A906031BA
APPLICATION / APLICACIÓN:
AUDI: A3 MK1 hatch 1.8 T 1996>2003, A4 MK2 Saloon 1.8 T/1.8 T quattro 2002>2004, A4 MK2 Avant/Estate 1.8 T/1.8 T quattro 2002>2004, TT Coupe MK1 1.8 T/1.8 T quattro 1998>2006, TT Roadster Cabrio MK1 1.8 T/1.8 T quattro 2000>2006
SEAT: Cordoba MK1 hatch 1.8 T 20V Cupra 2000>2002, Ibiza MK3 hatch 1.8 T 20V Cupra 2000>2002, Ibiza MK4 hatch 1.8 T FR/1.8 T Cupra R 2003>2008,
Leon MK1 hatch 1.8 20V T/1.8 20V T 4 1999>2006, Toledo MK2 Saloon 1.8 20VT 2000>2004
SKODA: Octavia MK1 hatch 1.8 T/1.8 T 4x4/RS 1.8 T 1997>2010, Octavia MK1 Estate 1.8 T/1.8 T 4x4/RS 1.8 T 1998>2010
VW: Bora Saloon 1.8 T 2000>2005, Bora Estate 1.8 T 2000>2005, Golf MK4 hatch 1.8 T/1.8 T GTI 1997>2005, Golf MK4 Estate 1.8 T 2000>2006, New Beetle 1.8 T 1999>2010, New Beetle Convertible 1.8 T 2003>2010, Polo MK4 4/4F hatch 1.8 GTI/1.8 GTi Cup Edition 2005>2009



G19063

REPLACES / REEMPLAZA:
Bosch: 0 280 156 063
VW/Audi: 06A906031BC
APPLICATION / APLICACIÓN:
AUDI: A3 MK1 hatch S3 quattro 1999>2003, TT Coupe MK1 1.8 T quattro 1998>2006
SEAT: Leon MK1 hatch 1.8 T Cupra R 2002>2006



G19064

REPLACES / REEMPLAZA:

Multipoint System

REPLACES / REEMPLAZA:

IWP 064; ORIGINAL: 71718998;

MAGNETI MARELLI: 4310006400

APPLICATION / APLICACIÓN:

FIAT: Palio 16V 1.6 MPI Gas. 00-01>, Palio Siena 16V 1.6 MPI Gas. 01>, Palio Weekend 16V 1.6 MPI Gas. 00-01>, Palio Strada/ Brava/ Doblò 16V 1.6 MPI Gas. 02 >



G19065

REPLACES / REEMPLAZA:

IWP 065; Magneti Marelli: 501 013 02; **Fiat:** 7078993

APPLICATION / APLICACIÓN:

FIAT: Fiorino Furgão 1.5 (MPI - gasoline) 97>, Fiorino Furgão 4,5,6 1.5 (MPI - gasoline) 98>, Fiorino Pick-up 1.5 (MPI - gasoline) 97>, Fiorino Pick-up 4,5,6 1.5 (MPI - gasoline) 98>, Palio 1.0/1.5 (MPI - gasoline) 96>, Palio 1.3 (MPI - gasoline) 98>, Palio Fire 1.0 (MPI - gasoline) 99>, Palio RST, Young Fire 1.0 (MPI - gasoline) 99>, Palio, Siena 1.0 (flex) 06>, Palio, Strada 1.5 (MPI - gasoline) 99>, Palio Weekend 1.0 6 marchas (MPI - gasoline) 98>, Palio Weekend 1.5 (MPI - gasoline) 96>, Uno Fire 1.0 (MPI - gasoline) 02>, Uno Fire 1.0 (flex) 04>, Uno 1.3 (MPI - gasoline) 01>, Uno Furgoneta 1.5 (MPI - gasoline) 96>



G19066

REPLACES / REEMPLAZA:

IWP 066; Magneti Marelli: 501 015 02

APPLICATION / APLICACIÓN:

FIAT: Palio, Siena, Strada, Weekend 1.5 (MPI - alcohol) 97>00



G19067

REPLACES / REEMPLAZA:

IWP 067; Fiat: 7081247

APPLICATION / APLICACIÓN:

FIAT: Palio, Uno Mille 1.0 (MPI - alcohol) 99>00, Palio, Siena, Strada, Weekend 1.6 (gasoline) 99>00



G19071

REPLACES / REEMPLAZA:

IWP 071

APPLICATION / APLICACIÓN:

MERCEDES BENZ: Classe A (A160/190) (gasoline) 99>05



G19086

REPLACES / REEMPLAZA:

Bosch: 0 280 156 086

GM: 93392558, 93298396

APPLICATION / APLICACIÓN:

CHEVROLET: Astra 2.0 MPFI Flexpower 04>08, Astra Sedan 1.8 MPFI 01>04, Blazer 2.4 MPFI Flexpower 07>08, S-Serie S10 2.4 MPFI Flexpower 07>08, Vectra 2.0 Flexpower 05>09, Vectra 2.0 Flexpower Next Edition 09>11, Vectra Hatch 2.0 Flexpower 07>11, Zafira 2.0 MPFI Flexpower 04>08



G19090

REPLACES / REEMPLAZA:

Bosch: 0 280 156 090

GM: 93362611

APPLICATION / APLICACIÓN:

CHEVROLET: Classic 1.6 2004>, Corsa Tenuta 1.6 GLS 1997>2002, Corsa hatchback 1.6 GLS 1994>2002, Corsa pick-up 1.6 1994>2002, Corsa Saloon 1.6 2005>2010, Corsa Saloon 1.6 GLS 1994>2002



G19092

REPLACES / REEMPLAZA:

IWP 092; Magneti Marelli: 501 025 02

APPLICATION / APLICACIÓN:

VW: Polo 16V 1.0 (MPI - gasoline) 01>



G19096

REPLACES / REEMPLAZA:

Bosch: 0 280 156 096

Seat/Volkswagen: 032906031D

APPLICATION / APLICACIÓN:

SEAT: Cordoba MK2 Saloon 1.6 03>09



G19099

REPLACES / REEMPLAZA:

IWP 099; Magneti Marelli: 501 021 02

APPLICATION / APLICACIÓN:

PEUGEOT: 206 1.0 16V;
RENAULT: Clio, Kangoo 1.0 16V 00>, Scénic 1.6 16V (gasoline)



GI9101

REPLACES / REEMPLAZA:
IWP 101; Magneti Marelli: 501 023 02
 APPLICATION / APLICACIÓN:
FIAT: Siena, Weekend Fire 1.0 16V (MPI) 03>



GI9105 // NEW //

REPLACES / REEMPLAZA:
GM: 93214012; **DELPHI:** ICD00105; **VDO:** DGM105
 APPLICATION / APLICACIÓN:
GM: S10 1995>2000, Monza 1992>1996, Kadett 1.8/2.0 EFI 1992>1998, Blazer 2.2 EFI 1991>1996



GI9106

REPLACES / REEMPLAZA:
Delphi: ICD00106
Chevrolet: 93227669
 APPLICATION / APLICACIÓN:
GM: Corsa 1.0 8V Gasoline 1994>1996



GI9110

REPLACES / REEMPLAZA:
GM: 17124782; **DELPHI:** ICD00110
 APPLICATION / APLICACIÓN:
GM: Corsa 1.0 2000>2005, Corsa 1.4/1.6 1996>1999



GI9111 // NEW //

REPLACES / REEMPLAZA:
BOSCH: 0 280 157 111;
VOLKSWAGEN: 032 906 031 S
 APPLICATION / APLICACIÓN:
VOLKSWAGEN: Gol V 1.0 8V Total Flex 2008>, Fox 1.0 8V Total Flex 2010>, Voyage 1.0 8V Total Flex 2012>



GI9113

REPLACES / REEMPLAZA:
Magneti Marelli: 501.009.02 (IWP113)
Audi/Volkswagen/Seat: 036 906 031 C
 APPLICATION / APLICACIÓN:
AUDI: A2 hatch 1.4 2000>2005
VOLKSWAGEN: Golf Mk4 hatch/estate 1.4 16v 1997>2005, Lupo hatch 1.4 16v 1998>2005, Polo Classic Mk3 Saloon 75 1.4 16v 1999>2001, Polo Mk3 estate/hatch 1.4 16v 1999>2001
SEAT: Arosa hatch 1.4 16v 2000>2004, Cordoba Mk1 saloon/estate 1.4 16v 2000>2002, Ibiza Mk2 hatch 1.4 16v 2000>2002, Leon Mk1 hatch 1.4 16v 1999>2006, Toledo Mk2 Saloon 1.4 16v 2000>2002



GI9114

REPLACES / REEMPLAZA:
IWP 114; Magneti Marelli: 501 019 02;
VW: 041 906 031
 APPLICATION / APLICACIÓN:
VW: Gol, Parati, Saveiro GIII 1.8 (gasoline) 00>, Quantum, Santana 1.8 (Mi - gasoline) 00>



GI9115

REPLACES / REEMPLAZA:
IWP 115; Magneti Marelli: 501 020 02
 APPLICATION / APLICACIÓN:
VW: Gol, Parati, Saveiro 1.6/1.8 (Total flex) 04>, Gol, Parati, Saveiro 2.0 (gasoline) 99>



GI9116

REPLACES / REEMPLAZA:
IWP 116; Fiat/ Lancia: 71791243
 APPLICATION / APLICACIÓN:
FIAT: Doblo MPV 1.2 2001->, Doblo cargo van 1.2 2001->, Palio Weekend Estate 1.2 J2001->, Panda Mk1 hatch 1100 Trekking 4x4 1991>2004 / 1100 1995>2003 / 1100 4x4 1995>2004, Punto Mk2 hatch 1.2 60 1999>2010, Punto Mk2 Van 1.2 60 2000>2009, Seicento hatch 1.1 1998>2010, Strada Pickup 1.2 1999>2006
LANCIA: Y 1.2 1996>2003



GI9117

REPLACES / REEMPLAZA:
Bosch: 0 280 157 117, 0 280 157 113
 APPLICATION / APLICACIÓN:
NISSAN: Sentra 2.0 Flex 09>

GI9118



REPLACES / REEMPLAZA:
Delphi: ICD00118
GM: 17123919
 APPLICATION / APLICACIÓN:
GM: Corsa 1.0 8V Gasoline MPFI 1996>1998

GI9119



REPLACES / REEMPLAZA:
IWP 119; Magneti Marelli: 501 032 02
 APPLICATION / APLICACIÓN:
FORD: Ka (RoCam), Novo Fiesta 8V 1.0L/1.3L (gasoline) 04>

GI9127



REPLACES / REEMPLAZA:
IWP 127; Magneti Marelli: 501 033 02
 APPLICATION / APLICACIÓN:
FORD: Fiesta, EcoSport 1.6 Zetec RoCam (gasoline), Fiesta, EcoSport 1.0 8V, Supercharger (gasoline)

GI9131



REPLACES / REEMPLAZA:
IWP 131; Magneti Marelli: 501 029 02
 APPLICATION / APLICACIÓN:
FIAT: Palio, Siena, Strada, Weekend RST 8V 1.3L (Fire - flex) >03

GI9143



REPLACES / REEMPLAZA:
IWP 143; Magneti Marelli: 501 026 02;
Renault: 8 200 128 959
 APPLICATION / APLICACIÓN:
RENAULT: Clio, Scénic 1.6 16V 01>, Partner 1.8 8V (MPI - gasolineE) 01>

GI9144



REPLACES / REEMPLAZA:
Bosch: 0 280 156 144
VW: 030 906 031 T
 APPLICATION / APLICACIÓN:
VW: Gol III 1.0Mi 2001>2005

GI9145 // NEW //



REPLACES / REEMPLAZA:
BOSCH: 0 280 157 145; **NISSAN:** 16600-3RZ0A
 APPLICATION / APLICACIÓN:
NISSAN: Sentra 2.0 Flex 2016>

GI9151



REPLACES / REEMPLAZA:
Bosch: 0 280 156 151
GM: 93 325 236
 APPLICATION / APLICACIÓN:
GM: Celta 1.4 MPFI 2003>2006

GI9152



REPLACES / REEMPLAZA:
Bosch: 0 280 156 152
GM: 93325238
FIAT: 7083305
 APPLICATION / APLICACIÓN:
OPEL: Corsa 1.8 8V 2002>
FIAT: Stilo 1.8 8V 2002>

GI9153



REPLACES / REEMPLAZA:
Bosch: 0 280 156 153
GM: 93323289
FIAT: 7083304
 APPLICATION / APLICACIÓN:
CHEVROLET: Meriva 1.8 SFI 16V 02>03
FIAT: Stilo 1.8 MPI 16V 02>04

GI9157

REPLACES / REEMPLAZA:
IWP 157; Magneti Marelli: 501 027 02
 APPLICATION / APLICACIÓN:
FIAT: Doblò 1.8L 8V (gasoline) 03>, Palio RST 1.8L 8V (gasoline) 04>

GI9158

REPLACES / REEMPLAZA:
IWP 158
 APPLICATION / APLICACIÓN:
FIAT: Palio; Doblò 1.8;
VW: Gol, Parati, Saveiro

GI9160 // NEW //

REPLACES / REEMPLAZA:
Denso: 2325016160
 APPLICATION / APLICACIÓN:
Toyota: Corolla 1.8 8V/16V 1998>2002 Gasolina

GI9164

REPLACES / REEMPLAZA:
Bosch: 0 280 156 164
 APPLICATION / APLICACIÓN:
HONDA: Fit 1.4i 8V 03>08

GI9168

REPLACES / REEMPLAZA:
IWP 168; Magneti Marelli: 501 031 02
 APPLICATION / APLICACIÓN:
FIAT: Palio RST II 1.8 (Fire - Flex) (MPI - alcohol/gasoline) 04>

GI9170

REPLACES / REEMPLAZA:
IWP 170; Magneti Marelli: 501 028 02
 APPLICATION / APLICACIÓN:
VW: Fox 1.0L 16V (MPI - gasoline), Gol (Total flex) 03>

GI9173

REPLACES / REEMPLAZA:
Bosch: 0 280 156 173
VW: 06A906031BQ
 APPLICATION / APLICACIÓN:
VW: Bora Sallón 2.0 1998>2005

GI9174

REPLACES / REEMPLAZA:
IWP 174; Magneti Marelli: 501 001 02
 APPLICATION / APLICACIÓN:
FIAT: Tempra 2.0L 16V 95>99;
VW: Gol, Parati 2.0L 16V (MPI - gasoline) 96>

GI9176

REPLACES / REEMPLAZA:
IWP 176; Magneti Marelli: 501 034 02
 APPLICATION / APLICACIÓN:
VW: Gol GIV/ GV, Fox, Voyage (MPI - Total Flex) 2005

GI9179

FEATURES / CARACTERÍSTICAS:
 Multipoint System
 REPLACES / REEMPLAZA:
IWP 179
 APPLICATION / APLICACIÓN:
RENAULT: Clio II 1.6 16V (Hi - Flex) 07/04>, Kangoo, Mégane, Scénic 1.6 16V (Hi - Flex) 07/04>

GI9191 // NEW //

FEATURES / CARACTERÍSTICAS:
 ...
 REPLACES / REEMPLAZA:
BOSCH: 0 280 158 191
 APPLICATION / APLICACIÓN:
FORD: Edge 3.5/3.7 V6 2011>2015, Taurus 3.5/3.7 2011>2015, Mustang 3.5/3.7 2011>2015

GI9210

REPLACES / REEMPLAZA:
IWP210; Magneti Marelli: 501.044.92
 APPLICATION / APLICACIÓN:
CITROËN/ PEUGEOT: All 1.4 2008> Flex MPI

GI9211

REPLACES / REEMPLAZA:
IWP211; Magneti Marelli: 501.743.02
Ford: 9S4G9F593CA
 APPLICATION / APLICACIÓN:
Ford: Ka 1.0 2008>2010 Flex MPI

GI9212

REPLACES / REEMPLAZA:
IWP2012; Magneti Marelli: 501.744.02
 APPLICATION / APLICACIÓN:
Ford: Ka 1.6 2008>2010 Flex MPI

GI9214

REPLACES / REEMPLAZA:
Bosch: 0 280 156 214
GM: 93309823
 APPLICATION / APLICACIÓN:
CHEVROLET: Corsa 1.8 MPFI Flexpower 03>05, Meriva 1.8 MPFI Flexpower 03>05, Montana 1.8 MPFI Flexpower 03>05

GI9218

REPLACES / REEMPLAZA:
Bosch: 0 280 156 018
Fiat: 46528855
 APPLICATION / APLICACIÓN:
FIAT: Marea 2.4 MPI 20V 00>07, Marea Weekend 2.4 MPI 20V 00>07, Stilo 2.4 MPI 20V 02>08

GI9225

REPLACES / REEMPLAZA:
Bosch: 0 280 156 225
VW: 032906031E
 APPLICATION / APLICACIÓN:
VW: Fox 1.6 Total Flex 03>05

GI9228

REPLACES / REEMPLAZA:
IWP228
 APPLICATION / APLICACIÓN:
Hyundai: Tucson, Santa Fé

GI9231

REPLACES / REEMPLAZA:
Bosch: 0 280 156 231
Renault: 8200323215
 APPLICATION / APLICACIÓN:
RENAULT: Clio II 1.0i 16V Hi-Power 2005

GI9252

REPLACES / REEMPLAZA:
Bosch: 0 280 156 252
VW: 032906031F
 APPLICATION / APLICACIÓN:
VW: Fox 1.6 03>04

GI9269

REPLACES / REEMPLAZA:
Bosch: 0 280 156 269
Fiat: 55100258
 APPLICATION / APLICACIÓN:
FIAT: Idea 1.4 MPI flex, Palio 1.4 MPI, Punto 1.4 MPI

GI9274 // NEW //

REPLACES / REEMPLAZA:
Bosch: 0 280 156 274
Volkswagen: 032906031H
 APPLICATION / APLICACIÓN:
Volkswagen: CrossFox 1.6 Total Flex 2005>2008, Fox 1.6 Total Flex 2005>2008, Golf IV 1.6 Total Flex 2006>2007, Kombi 1.4 Total Flex 2006>2008, Polo 1.6 Total Flex 2004>2007, SpaceFox 1.6 Total Flex 2006>2008

GI9276 // NEW //

REPLACES / REEMPLAZA:
BOSCH: 0 280 158 276
 APPLICATION / APLICACIÓN:
NISSAN: March 1.6 16V Flex 2012>, Versa 1.6 16V Flex 2012>;
MITSUBISHI: Asx 2.0 16V 2011>

GI9281

REPLACES / REEMPLAZA:
Bosch: 0 280 156 281
GM: 93383636
 APPLICATION / APLICACIÓN:
CHEVROLET: Vectra 2.4 16V Flexpower 05>09

GI9286

REPLACES / REEMPLAZA:
Bosch: 0 280 156 286
GM: 93385683
 APPLICATION / APLICACIÓN:
CHEVROLET: Corsa 1.0 VHC Flexpower 05>08

GI9310 // NEW //

REPLACES / REEMPLAZA:
HYUNDAI: 35310-3C400
 APPLICATION / APLICACIÓN:
HYUNDAI: Santa Fé 2009>2019, Grand Santa Fé 2013>2018, Azera 2011>2016, Grandeur/Azera 2017>2019, Palisade 2019>

GI9357

FEATURES / CARACTERÍSTICAS:
 Similar GI9002 (Sagem model)
 REPLACES / REEMPLAZA:
Sagem: 01F002A
Citroën/Peugeot: 1984 E0
Bosch: 0 280 156 357
 APPLICATION / APLICACIÓN:
CITROËN: Berlingo MultiSpace 1.4 1996>2008, Berlingo Van 1.4 1996>, C2 1.4 2003>, C3 1.4 2002>, C3 Pluriel 2003>, Saxo hatch 1.4 1996>2004, Xsara hatch 1.4 1997>2005, Xsara Estate 1.4 1997>2010, Xsara Coupe 1.4 1998>2005
PEUGEOT: 106 MK 2 hatch 1.4 1996>, 206 hatch 1.4 1998>, 206 Saloon 1.4 2007>, 206 SW Estate 1.4 2002>, 306 Sallion 1.4 SL 1993>2003, 306 Estate 1.4 1994>2002, 307 hatch 1.4 2000>, 307 Estate 1.4 2002>, 307 SW Estate 1.4 2002>, 1007 1.4 2005>, Partner MK1 MPV 1.4 1996>, Partner MK1 Van 1.4 1996>

GI9414 // NEW //

REPLACES / REEMPLAZA:
Fiat/ Jeep: 55257414
Magneti Marelli: IPE057
 APPLICATION / APLICACIÓN:
FIAT: Argo HGT 1.8 2017>, Toro 1.8 16V 2016>,
JEEP: Renegade 1.8 16V 2016>

GI9450 // NEW //

REPLACES / REEMPLAZA:
Honda: 16450-RNA-A01
 APPLICATION / APLICACIÓN:
Honda: Fit 1.5 2009>2013, Civic 1.3 2006>2011, New Civic 1.8 2006>2011

GI9298

REPLACES / REEMPLAZA:
Bosch: 0 280 156 298
GM: 93 345 364
 APPLICATION / APLICACIÓN:
GM: Celta 1.0 VHC Flexpower 2005>2008, Corsa Sedan 1.0 VHC Flexpower 2006>2008

GI9315 // NEW //

REPLACES / REEMPLAZA:
BOSCH: 0 280 158 315; **MEAT & DORIA:** 75114315
 APPLICATION / APLICACIÓN:
VOLVO: C30 T5 2006>2012, C70 li Conversível T5 2006>2009, S40 li T5 2004>2012, S40 li T5 Awd 2004>2010, S60 li 2.0 T 2012>2015, S80 li 2.5 T 2006>, S80 li 2.5 T Flexfuel 2008>2011, V40 Hatch T4 2013>2015, V40 Hatch T4 Awd 2013>, V40 Hatch T5 2012>, V50 T5 2004>2012, V50 T5 Awd 2004>2010, V60 I T5 2013>, V70 lii 2.5 T 2007>2012, V70 lii 2.5 T Flexifuel 2008>2011, Xc60 T5 Awd 2014>2017

GI9403 // NEW //

REPLACES / REEMPLAZA:
BOSCH: 0 280 156 403
VOLKSWAGEN: 032 906 031 R
 APPLICATION / APLICACIÓN:
VOLKSWAGEN: Fox Hatch 1.6 Rock In Rio Plus Total Flex 2009>2014, Fox Hatch 1.6 Trendline Flex 2014>, Gol V 1.6 Total Flex 2008>, Gol Vi 1.6 Comfortline Highline I-Motion Trendline 2012>, Polo 1.6 Cfl Total Flex 2004>2008, Polo 1.6 Total Flex 2008>2014, Polo Sedan 1.6 Total Flex 2008>2014, Saveiro V 1.6 Cross Flex 2009>, Saveiro Vi 1.6 Total Flex 2014>2016, Spacefox / Space Cross 1.6 Plus Total Flex 2006>, Voyage 1.6 Comfortline Evidence Highline I-Motion Trendline Fle 2008>, Voyage 1.6 Flex 2008>

GI9436 // NEW //

REPLACES / REEMPLAZA:
Bosch: 0 280 156 436;
Fiat: 55233620
 APPLICATION / APLICACIÓN:
FIAT: Uno Mille II Economy 1.0 MPI Flex 2010>

GI9500

REPLACES / REEMPLAZA:
IWM 50001; Magneti Marelli: 501 002 02
 APPLICATION / APLICACIÓN:
VÁRIAS: Fiat, Ford, Renault, VW 1.5/1.6L (SPI - gasoline)
 *monoponto

GI9502 // NEW //



REPLACES / REEMPLAZA:
Bosch: 0 280 150 502; **Kia:** 0K01D 13250, 0K010 13250
APPLICATION / APLICACIÓN:
KIA: Retona 2.0 16V 00>, Sportage Mk1 SUV 2.0/2.0 4WD/2.0 i 16V/2.0 i 16V 4WD 94>03
PS: GI9504 set

GI9504 // NEW //



REPLACES / REEMPLAZA:
Bosch: 0 280 150 504; **Kia:** 0K01D 13260, 0K010 13260
APPLICATION / APLICACIÓN:
KIA: Retona 2.0 16V 00>, Sportage Mk1 SUV 2.0/2.0 4WD/2.0 i 16V/2.0 i 16V 4WD 94>03
PS: GI9502 set

GI9518



REPLACES / REEMPLAZA:
IWP218; Magneti Marelli: 501.050.02
APPLICATION / APLICACIÓN:
Mitsubishi: Pajero V6 2008-> Gasoline MPI

GI9523



REPLACES / REEMPLAZA:
IWM 52300; Magneti Marelli: 501 003 02
APPLICATION / APLICACIÓN:
MISCELLANEOUS: Fiat, VW 1.0L (SPI - gasoline) (monopunto)

GI9534



REPLACES / REEMPLAZA:
Bosch: 0 280 157 153
Fiat: 55258534
APPLICATION / APLICACIÓN:
FIAT: Mobi 1.0 2017>, Novo uno 1.0 2015>2017

GI9593 // NEW //



REPLACES / REEMPLAZA:
Magneti Marelli: IPE007; **FORD:** AS65.9F593. AA, DK.0093699.A
APPLICATION / APLICACIÓN:
FORD: New Ka

GI9680



REPLACES / REEMPLAZA:
Sagem: D2159MA
Citroën/ Peugeot: 1984-87
APPLICATION / APLICACIÓN:
CITROËN: ZX hatch 1.6i 1991>1997, ZX Estate 1.6i 1993>1997;
PEUGEOT: 405 Mk2 Saloon 1.6 1992>1995, 405 Mk2 Estate 1.6 1992>1996

GI9698



REPLACES / REEMPLAZA:
Bosch: 0 280 150 698
APPLICATION / APLICACIÓN:
FIAT: Tipo 1.6 93/95 SPI 8 Válvulas Gasoline;
RENAULT: Clio 1.6 96- SPI, R19 1.6 96-. SPI;
VW: Golf 1.6

GI9812



REPLACES / REEMPLAZA:
Bosch: 0 280 155 812
VW: 309060311
APPLICATION / APLICACIÓN:
VW: Gol II 1.0Mi / 8V 96>99, Gol II Special 1.0Mi 8V 99>05, Gol III 1.0Mi 99>01

GI9820 // NEW //



REPLACES / REEMPLAZA:
GM: 24578820
APPLICATION / APLICACIÓN:
GM: Cobalt 1.4L/1.8L, Prisma 1.4L 8V 2013>2015, Onix 1.4L 8V 2013>2015, Corsa 1.4L 8V 2012>, Astra 1.4L 1.8L, Vectra 1.4L 1.8L

GI9821



REPLACES / REEMPLAZA:
Bosch: 0 280 155 821
GM: 93 267 340
APPLICATION / APLICACIÓN:
GM: Blazer / S10 2.2 MPFI 1997>2000, Blazer / S10 2.4 MPFI 2000>2007, Vectra 2.0 MPFI 1997>2005, Vectra 2.2 MPFI 1997>2002

GI9822



REPLACES / REEMPLAZA:
Bosch: 0 280 155 822
Alfa Romeo: 55180816
GM: 93290696
APPLICATION / APLICACIÓN:
ALFA ROMEO: Alfa 156 Berlina 2.0 TS 16V 97>01
GMC: C4500 Topkick 2003>2009
GM: Vectra 2.2 SFI 16V

GI9835

REPLACES / REEMPLAZA:
Bosch: 0 280 155 835
VW: 409060315
 APPLICATION / APLICACIÓN:
VW: Kombi comercial 1.6 1995>2005, Kombi comercial 1.6 1997>2005

GI9845 // NEW //

REPLACES / REEMPLAZA:
Renault: H106845
 APPLICATION / APLICACIÓN:
Renault: Fluence 2.0 16v Flex 2011>2017

GI9888

REPLACES / REEMPLAZA:
Bosch: 0 280 155 888
Ford: XS5U9F593HA
 APPLICATION / APLICACIÓN:
Ford: Fiesta IV 1.0 1999>2002, Fiesta Mk IV 1.0 i 1999>2002, Sedan Fiesta 1.0, Ikon sedan 1.0 2001>2004, Ka 1.0 1999>2008

GI9892

REPLACES / REEMPLAZA:
IWP030; Magneti Marelli: 501.038.92
 APPLICATION / APLICACIÓN:
Mitsubishi: Pajero TR4 2.0 16V 2008-> Flex MPI

GI9905

REPLACES / REEMPLAZA:
Bosch: 0 280 155 905
Ford: 98BF9F593CA
 APPLICATION / APLICACIÓN:
FORD: Ka 1.3i 1996>2008

GI9925

REPLACES / REEMPLAZA:
Bosch: 0 280 155 925
Ford: YS6U9F593HA
 APPLICATION / APLICACIÓN:
FORD: Courier 1.6i 99>08, Courier Van 1.6i 06>08, Escort 1.6i/SW 1.6i 00>02, Fiesta II 1.6i 99>05, Ka 1.6i 01>07

GI9929

REPLACES / REEMPLAZA:
Bosch: 0 280 155 929
GM: 93 275 197
 APPLICATION / APLICACIÓN:
GM: Astra Sedan 1.8 MPFI 1998>2001, Astra Sedan 2.0 MPFI 1998>, Zafira 2.0 MPFI 2001>

GI9930

REPLACES / REEMPLAZA:
Bosch: 0 280 155 930
GM: 93275196
 APPLICATION / APLICACIÓN:
GM: Zafira 2.0 01>12

GI9962 // NEW //

REPLACES / REEMPLAZA:
BOSCH: 0 280 150 962; **Fiat:** 46436147, 46559066;
GM: 90444453, 93208787
 APPLICATION / APLICACIÓN:
Alfa Romeo: Spider (916_) 1994>2005;
OPEL: Senator B (V88) 1987>1993

GI9966

REPLACES / REEMPLAZA:
Bosch: 0 280 155 966
GM: 17124717
 APPLICATION / APLICACIÓN:
GM: Corsa hatchback 1.0 1994>2000, Corsa sedan 1.0 1994>2000

GI9979

REPLACES / REEMPLAZA:
Bosch: 0 280 155 979
VW: 309060317
 APPLICATION / APLICACIÓN:
VW: Gol II 1.0Mi 8V 98>99, Gol II Special 1.0Mi 8V 99>05, Gol III 1.0Mi 99>05



EMS COMPONENTS | SISTEMA DE CONTROL DE MOTOR

AIR FLOW METER | MAF



GH5001

REPLACES / REEMPLAZA:

VW: 06A 906 461; **BOSCH:** 0 280 217 121, 0 280 217 122; **FORD:** 95 VW12B529 BB

APPLICATION / APLICACIÓN:

AUDI: A3(8L1) 1.9 TDI HATCHBACK 09.96-07.01 66 90 1896, A3(8L1) 1.9 TDI HATCHBACK 10.00 74 100 1896, A3(8L1) 1.9 TDI HATCHBACK 08.97-07.01 81 110 1896, A4(8E2,B6) 1.9TDI SALOON 05.01 74 101 1896;

FORD: GALAXY(WGR) 1.9 TDI MPV 03.95 66 90 1896, GALAXY(WGR) 1.9 TDI MPV 08.97-04.00 81 110 1896, GALAXY(WGR) 1.9 TDI MPV 04.00 85 115 1896;

SKODA: FABIA(6Y2) 1.9 TDI HATCHBACK 01.00 74 100 1896, FABIA COMBI(6Y5) 1.9 TDI ESTATE 04.00 74 100 1896, FABIA SALOON(6Y3) 1.9 TDI SALOON 01.00 74 100 1896, OCTAVIA(1U2) 1.9 TDI HATCHBACK 08.97 81 110 1896, OCTAVIA(1U2) 1.9 TDI HATCHBACK 09.96 66 90 1896, OCTAVIA COMBI(1U5) 1.9 TDI ESTATE 07.98 81 110 1896, OCTAVIA COMBI(1U5) 1.9 TDI ESTATE 07.98 81 110 1896, OCTAVIA COMBI(1U5) 1.9 TDI 4X4 ESTATE 09.00 74 100 1896, OCTAVIA COMBI(1U5) 1.9 TDI 4X4 ESTATE 11.99-09.00 66 90 1896;

VW: BORA(1J2) 1.9 TDI SALOON 09.00 74 101 1896, BORA(1J2) 1.9 TDI SALOON 10.98-06.01 81 110 1896, BORA(1J2) 1.9 TDI SALOON 10.98-06.01 66 90 1896, BORA(1J2) 1.9 TDI SALOON 12.98-06.01 85 115 1896, BORA(1J2) 1.9 TDI 4MOTION SALOON 09.00 74 101 1896, BORA(1J2) 1.9 TDI 4MOTION SALOON 02.99-06.01 85 115 1896, BORA(1J2) 1.9 TDI 4MOTION SALOON 02.99-06.01 66 90 1896, BORA ESTATE(1J6) 1.9 TDI 09.00 74 101 1896, BORA ESTATE(1J6) 1.9 TDI 05.99-06.01 81 110 1896, BORA ESTATE(1J6) 1.9 TDI 05.99-06.01 66 90 1896, BORA ESTATE(1J6) 1.9 TDI 4MOTION 05.99-06.01 85 115 1896, BORA ESTATE(1J6) 1.9 TDI 4MOTION 09.00 74 101 1896, GOLF IV(1J1) 1.9 TDI HATCHBACK 09.00 74 101 1896, GOLF IV(1J1) 1.9 TDI HATCHBACK 08.97-05.04 81 110 1896, GOLF IV(1J1) 1.9 TDI HATCHBACK 08.97-06.01 66 90 1896, GOLF IV(1J1) 1.9 TDI HATCHBACK 12.98-06.01 85 115 1896, GOLF IV(1J1) 1.9 TDI 4MOTION HATCHBACK 09.00 74 101 1896, GOLF IV(1J1) 1.9 TDI 4MOTION HATCHBACK 04.98-06.01 66 90 1896, GOLF IV(1J1) 1.9 TDI 4MOTION HATCHBACK 09.99-06.01 85 115 1896, GOLF IV VARIANT(1J5) 1.9 TDI ESTATE 09.00 74 101 1896, GOLF IV VARIANT(1J5) 1.9 TDI ESTATE 05.99-06.01 66 90 1896, GOLF IV VARIANT(1J5) 1.9 TDI 4MOTION ESTATE 09.00 74 101 1896, GOLF IV VARIANT(1J5) 1.9 TDI 4MOTION ESTATE 05.99-06.01 85 115 1896, GOLF IV VARIANT(1J5) 1.9 TDI 4MOTION ESTATE 05.99-06.01 66 90 1896, NEW BEETLE(9C1,1C1) 1.9 TDI HATCHBACK 01.98-02.01 66 90 1896, POLO(9N_) 1.4 TDI HATCHBACK 10.01 55 75 1422, POLO(9N_) 1.9 TDI HATCHBACK 10.01 74 101 1896, SHARAN(7M8,7M9,7M6) 1.9 TDI MPV 04.00 85 115 1896, SHARAN(7M8,7M9,7M6) 1.9 TDI MPV 09.96-04.00 81 110 1896, SHARAN(7M8,7M9,7M6) 1.9 TDI MPV 09.95 66 90 1896, SHARAN(7M8,7M9,7M6) 1.9 TDI 4 MOTION MPV 04.00 85 115 1896

GH5002

REPLACES / REEMPLAZA:

BOSCH: 0 280 217 123, 08 38 628, 90 529 673, 90 543 282; **SAAB:** 90 543 282

APPLICATION / APLICACIÓN:

OPEL: ASTRA G Estate(F35_) 1.2 16v 02.98-09.00 48 65 1199, ASTRA G Hatchback (F48_,F08_) 1.2 16v 02.98-09.00 48 65 1199, ASTRA Saloon (F69_) 1.2 16V 09.98-09.00 48 65 1199, CORSA B(73_,78_,79_,F35_)1.0 12V Hatch 11.96-09.00 40 54 973, CORSA B(73_,78_,79_,F35_)1.2 12V Hatch 03.98-09.00 48 65 1199;

VAUXH: ASTRA Mk IV 1.2 16V Saloon 09.98-09.00 48 65 1199, ASTRA Mk IV 1.2 16V Estate 02.98-09.00 48 65 1199, ASTRA Mk IV 1.2 16V Hatchback 02.98-09.00 48 65 1199, CORSA 1.0 12V Hatchback 11.96-09.00 40 54 973, CORSA 1.2 16V Hatchback 03.98-09.00 48 65 1199



GH5003

REPLACES / REEMPLAZA:

BOSCH: 0 280 218 019; **FIAT:** 46541253, 46447503, 60814852

APPLICATION / APLICACIÓN:

ALFA: 145(930) 1.6 i.e. 16V T.S.Hatchback 12.96-01.01 88 120 1598, 145(930) 1.6 i.e. 16V Hatchback 03.98-01.01 106 144 1598, 145(930) 1.9 JTD Hatchback 02.99-01.01 77 105 1910, 145(930) 1.9 TD Hatchback 10.94-02.99 66 90 1929, 145(930) 2.0 16V Quadrifoglio Hatchback 03.98-01.01 114 155 1970, 146(930) 1.6 i.e. 16V T.S. Hatchback 11.96-01.01 88 120 1598, 146(930) 1.6 i.e. 16V T.S. Hatchback 03.98-01.01 106 144 1747, 146(930) 1.9 JTD Hatchback 02.99-01.01 77 105 1910, 146(930) 1.9 TD Hatchback 12.94-02.99 66 90 1929, 146(930) 2.0 16V Quadrifoglio Hatchback 03.98-01.01 114 155 1970, 156(932) 1.6 16V T.SPARK(932A4) Saloon 09.97 88 120 1598, 156(932) 1.8 16V T.SPARK(932A3) Saloon 09.97-10.00 106 144 1747, 156(932) 1.9 JTD(932B2) Saloon 09.97-10.00 77 105 1910, 156(932) 2.0 16V T.SPARK(932A2) Saloon 09.97-10.00 114 155 1970, 156(932) 1.9 JTD(932B1) Saloon 09.97-10.00 100 136 2387, 156 Sportwagon (932) 1.6 16V T.Spark(932A4) 05.00 88 120 1598, 156 Sportwagon (932) 1.8 16V T.Spark(932A3) 05.00-10.00 106 144 1747, 156 Sportwagon (932) 1.9 JTD(932B2) 05.00-10.00 77 105 1910, 156 Sportwagon (932) 2.0 16V T.Spark(932A2) 05.00-10.00 114 155 1970, 156 Sportwagon (932) 2.4 JTD(932B1) 05.00-10.00 100 136 2387, 166 (936) 2.0 T.Spark(936A3A_) Saloon 09.98-10.00 114 155 1970, 166 (936) 2.4 JTD (936A2A_) Saloon 09.98-10.00 100 136 2387, GTV(916C_) 1.8 16V(916C3) Coupe 05.98 106 144 1747, GTV(916C_) 2.0 T.S 6V(916C2_)916C2C00 06.95 110 150 1970, Spider(916s_) 1.8 16v(916s3) convertible 05.98 106 144 1747, Spider(916s_)2.0T.spark16v(916s2b)convertible 05.98-08.00 114 155 1970, Spider(916s_)2.0T.spark16v(916scoo)convertible 06.95 110 150 1970;

FIAT: BRAVA(182) 1.9 JTD 105 Hatchback 12.98-10.01 77 105 1910, BRAVO(182) 1.9 JTD 105 Hatchback 12.98-10.01 77 105 1910, BRAVO(182) 2.0 HGT 20V(182AQ) Hatchback 07.98-10.01 113 154 1998, COUPE (FA/175) 2.0 20V 04.98 113 154 1998, MAREA(195) 1.9 JTD 105 Saloon 04.99-01.01 77 105 1910, MAREA(195) 2.0 155 20v Saloon 04.99-01.01 113 154 1998, MAREA Weekend(185) 1.9 JTD 105 Estate 04.99 77 105 1910, MAREA Weekend(185) 2.0 155 20V Estate 04.99-01.01 113 154 1998;

LANCIA: KAPPA(838A) 2.4 JTD(838AL1A4) Saloon 06.98-10.01 100 136 2387, KAPPA(838) 2.4 20V(838cc) Coupe 11.96-03.01 129 175 2446, KAPPA SW(838B) 2.0 20V(838BG1AA) 07.96-10.01 114 155 1998, KAPPA SW(838B)2.4 20V(838BC1AA) 07.96-10.01 129 175 2446838BC11A) Estate, KAPPA SW(838B)2.4 JTD(838BL1AA)Estate06.98-10.01 100 136 2387, LYBRA(839AX) 1.6 16V(839AXA1A) Saloon 07.99 76 103 1581, LYBRA(839AX) 1.8 16V(839AXB1A) 07.99 96 131 1747839AXG1A,) Saloon, LYBRA(839AX) 1.9 JTD (839AXD1A) Saloon 07.99-09.00 77 105 1910, LYBRA(839AX) 2.0 20V(839AXC11) 07.99-09.00 113 154 1998839AXC1A,) Saloon, LYBRA(839AX) 2.4 JTD (839AXE1A) Saloon 07.99-09.00 99 135 2387, LYBRA SW(839bx)1.6 6v(839AXA1A)Estate 07.99 76 103 1581, LYBRA SW(839bx)1.8 16v(839B1A, 07.99 96 131 1747839BXG1A) Estate, LYBRA SW(839BX)1.9JTD(839BXD1A)Estate 07.99-09.00 77 105 1910, LYBRA SW(839BX) 2.0 20V(839BXC11, 07.99-09.00 113 154 1998839BXC1A) Estate, LYBRA SW(839BX)2.4JTD(839BXE1A)Estate 10.99-09.00 99 135 2387





GH5004

REPLACES / REEMPLAZA:

BOSCH: 0 280 218 180, 0 281 002 180; **OPEL:** 90 530 767, 90 543 463, 836 592

APPLICATION / APLICACIÓN:

OPEL: ASTRA G Box (F70) 2.0 DI 01.99 60 82 1995, ASTRA G Estate (F35_) 2.0 DI 02.98 60 82 1995, ASTRA G Estate (F35_) 2.0 DTI 16V 08.99 74 101 1995, ASTRA G Hatchback (F48_F08_) 2.0 DI 02.98 60 82 1995, ASTRA G Hatchback (F48_F08_) 2.0 DTI 16V 08.99 74 101 1995, ASTRA G Saloon(F69_) 2.0 DI 09.98 60 82 1995, ASTRA G Saloon(F69_) 2.0 DTI 16V 08.99 74 101 1995;

VAUXH: ASTRA Mk IV 1.7DTI 16V Saloon 02.00 55 75 1686, ASTRA Mk IV 1.7TD Saloon 09.98-08.00 50 68 1700, ASTRA Mk IV 2.0DTI Saloon 09.98 60 82 1995, ASTRA Mk IV 2.0DTI 16V Saloon 08.99 74 101 1995, ASTRA Mk IV ESTATE 1.7 DTI 16V 02.00 55 75 1686, ASTRA Mk IV ESTATE 1.7 TD 02.98-08.00 50 68 1700, ASTRA Mk IV ESTATE 2.0 DI 02.98 60 82 1995, ASTRA Mk IV ESTATE 2.0 DTI 16V 08.99 74 101 1995, ASTRA Mk IV Hatchback 1.7 DTI 16V 02.00 55 75 1686, ASTRA Mk IV Hatchback 1.7 TD 02.98-08.00 50 68 1700, ASTRA Mk IV Hatchback 2.0 TD 02.98 60 82 1995, ASTRA Mk IV Hatchback 2.0 TD 08.99 74 101 1995, ASTRAVAN Mk IV 1.7 TD Box 08.98 50 68 1700, ASTRAVAN Mk IV 2.0 DI Box 08.98 60 82 1995, ASTRAVAN Mk IV 2.0 DI Box 04.04 74 100 1995, COMBO 1.7 DI 16V Box 09.01 48 65 1686, COMBO 1.7 DTI 16V Box 10.01 55 75 1686, CORSA Mk II 1.7 DI 16V Hatchback 09.00 48 65 1686, CORSA Mk II 1.7 DTI 16V Hatchback 09.00 55 75 1686, CORSAVAN Mk II 1.7 DI 16V Box 09.00 48 65 1686, CORSAVAN Mk II 1.7 DTI 16V Box 09.00 55 75 1686, OMEGA 2.0 DTI 16V Saloon 10.98-09.00 74 101 1995, OMEGA 2.0 DTI 16V Estate 10.98-09.00 74 101 1995, VECTRA 2.0 DI 16V Saloon 11.96 60 82 1995, VECTRA 2.0 DTI 16V Saloon 06.97 74 101 1995, VECTRA 2.0 DI 16V Estate 11.96 60 82 1995, VECTRA 2.0 DI 16V Estate 06.97 74 101 1995, VECTRA 2.0 DTI 16V Hatchback 06.97 74 101 1995, VECTRA 2.0 DI 16V Hatchback 11.96 60 82 1995, ZAFIRA 2.0 DI 16V MPV 10.99 60 82 1995, ZAFIRA 2.0 DTI 16V MPV 04.99 74 101 1995

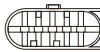

GH5005

REPLACES / REEMPLAZA:

BOSCH: 0 281 002 216, 0 281 002 217; **VW:** 028 906 461

APPLICATION / APLICACIÓN:

AUDI: A4(8D2,B5) 1.9 TDI Saloon 10.95-11.00 81 110 1896, A4(8D2,B5) 1.9 TDI Saloon 01.95-11.00 66 90 1896, A4(8D2,B5) 1.9 TDI Saloon 12.95-11.00 55 75 1896, A4(8D2,B5) 1.9 TDI Saloon 03.00-11.00 85 116 1896, A4(8D2,B5) 1.9 TDI Quattro Saloon 09.96-11.00 81 110 1896, A4(8D2,B5) 1.9 TDI Quattro Saloon 03.00-11.00 85 116 1896, A4 Avant(8D5,B5) 1.9 TDI Estate 03.00-09.01 85 115 1896, A4 Avant(8D5,B5) 1.9 TDI Estate 02.96-09.01 81 110 1896, A4 Avant(8D5,B5) 1.9 TDI quattro Estate 09.96-09.01 81 110 1896, A4 Avant(8D5,B5) 1.9 TDI quattro Estate 03.00-09.01 85 115 1896, A6(4B,C5) 1.9 TDI Saloon 02.97 81 110 1896, A6(4B,C5) 1.9 TDI Saloon 07.00 85 115 1896, A6 Avant (4B,C5) 1.9 TDI Estate 07.00 85 115 1896, A6 Avant (4B,C5) 1.9 TDI Estate 12.97 81 110 1896;

SEAT: CORDOBA(6K2) 1.9 TDI Hatchback 06.99-10.02 81 110 1896, CORDOBA(6K2) 1.9 TDI Hatchback 06.99-10.02 86 90 1896, CORDOBA Vario(6K5) 1.9 TDI Estate 06.99 66 90 1896, CORDOBA Vario(6K5) 1.9 TDI Estate 06.99 81 110 1896, IBIZA III(6K1) 1.9 TDI Hatchback 08.99-02.02 81 110 1896, IBIZA III(6K1) 1.9 TDI Hatchback 08.99-02.02 66 90 1896;

VW: CADY II Box(9K9A) 1.9 TDI 09.96-01.04 66 90 1896, CADY II Estate (9K9B) 1.9 TDI 10.96-01.04 66 90 1896, LT 28-35 II Bus (2DM) 2.5 SDI 07.96 55 75 2461, LT 28-35 II Bus (2DM) 2.5 TDI 05.99 80 109 2461, LT 28-35 II Bus (2DM) 2.5 TDI 05.99 66 90 2461, LT 28-35 II Box (2DX0AE) 2.5 SDI 09.96 55 75 2461, LT 28-35 II Box (2DX0AE) 2.5 TDI 05.99 80 109 2461, LT 28-35 II Box (2DX0AE) 2.5 TDI 05.99 66 90 2461, LT 28-35 II Flatbed/chassis (2DX0FE) 2.5 SDI 09.96 55 75 2461, LT 28-35 II Flatbed/chassis (2DX0FE) 2.5 TDI 05.99 80 109 2461, LT 28-35 II Flatbed/chassis (2DX0FE) 2.5 TDI 05.99 66 90 2461, PASSAT (3B2) 1.9 TDI Saloon 02.00-11.00 74 101 1896, PASSAT (3B2) 1.9 TDI Saloon 10.96-11.00 81 110 1896, PASSAT (3B2) 1.9 TDI Saloon 08.98-11.00 85 115 1896, PASSAT (3B2) 1.9 TDI Saloon 10.96-11.00 66 90 1896, PASSAT (3B2) 1.9 TDI Syncro/4motion Saloon 10.96-11.00 81 110 1896, PASSAT (3B2) 1.9 TDI Saloon 11.00 74 101 1896, PASSAT Variant (3B5) 1.9 TDI Estate 02.00-11.00 74 101 1896, PASSAT Variant (3B5) 1.9 TDI Estate 06.97-11.00 81 110 1896, PASSAT Variant (3B5) 1.9 TDI Estate 08.98-11.00 85 115 1896, PASSAT (3B5) 1.9 TDI Syncro/4motion Estate 06.97-11.00 81 110 1896, PASSAT Variant (3B6) 1.9 TDI Estate 11.00 74 101 1896, POLO CLASSIC(6KV2) 110 1.9 TDI Saloon 06.98-09.01 81 110 1896, POLO CLASSIC(6KV2) 0.9 1.9 TDI Saloon 09.96-09.01 66 90 1896, POLO Variant (6KV5) 1.9 TDI Estate 05.97-09.01 66 90 1896, POLO Variant (6KV5) 1.9 TDI Estate 06.98-09.01 81 110 1896, TRANSPORTER IV Box(70XA) 2.5TDI 12.98 65 88 2461, TRANSPORTER IV Box(70XA) 2.5TDI 09.95 75 102 2461, TRANSPORTER IV Box(70XA) 2.5TDI Syncro 09.95 75 102 2461, TRANSPORTER IV Bus(70XB,70XC,7DB,7DW) 05.98 65 88 2461, 2.5TDI, TRANSPORTER IV Bus(70XB,70XC,7DB,7DW) 09.95 75 102 2461, 2.5TDI, TRANSPORTER IV Bus(70XB,70XC,7DB,7DW) 01.96 75 102 2461, 2.5TDI Syncro, TRANSPORTER IV Flatbed/Chassis(70XD) 05.98 65 88 2461, 2.5TDI, TRANSPORTER IV Flatbed/Chassis(70XD) 09.95 75 102 2461, 2.5TDI, TRANSPORTER IV Flatbed/Chassis(70XD) 05.98 75 102 2461, 2.5TDI Syncro



GH5006

REPLACES / REEMPLAZA:

BOSCH: 0 281 002 309; **FIAT:** 46 559 804, 60 816 137, 55 193 048

APPLICATION / APLICACIÓN:

ALFA: 147(937) 1.6 16V T.SPARK(937AXB1A)Hatch 01.01 88 120 1598, 147(937) 1.6 16V T.SPARK ECO(937AXA1A) 01.01 76 103 1598, 147(937) 2.0 16V T.SPARK(937AXC1_)Hatch 01.01 110 150 1970, 156(932) 1.6 16V T.SPARK(932A4)Saloon 09.97 88 120 1598, 156(932) 1.8 16V T.SPARK(932A31_)Saloon 10.00 103 140 1747, 156(932) 1.9 JTD(932A2B,932A2C)Saloon 05.01 85 115 1910, 156(932) 1.9 JTD(932A2B_)Saloon 10.00-05.01 81 110 1910, 156(932) 2.0 16V T.SPARK(932A21_)Saloon 10.00-03.02 110 150 1970, 156(932) 2.4 JTD(932A1B_)Saloon 10.00 103 140 2387, 156(932) 2.4 JTD(932AXC)Saloon 03.02 110 150 2387, 156 Sportwagon (932)1.6 16V T.SPARK 05.00 88 120 1598, (932A4) Estate, 156 Sportwagon (932)1.8 16V T.SPARK 10.00 103 140 1747, (932B31_) Estate, 156 Sportwagon (932)1.9 JTD(932B2B, 05.01 85 115 1910, 932B2C) Estate, 156 Sportwagon (932)1.9 JTD(932B2B_)Estate 10.00-05.01 81 110 1910, 156 Sportwagon (932)2.0 16V T.SPARK (932)2.0 16V T.SPARK 10.00-03.02 110 150 1970, (932B21_) Estate, 156 Sportwagon (932)2.4 JTD(932B1B_)Estate 10.00 103 140 2387, 156 Sportwagon (932)2.4 JTD(932BXC)Estate 03.02 110 150 2387, 166(936) 2.0 T.SPARK(936A3B_)Saloon 10.00 110 150 1970, 166(936)2.4JTD Saloon 04.02 110 150 2387, 166(936)2.4JTD (936A2B_)Saloon 10.00 103 140 2387, GT 1.8TS Coupe 11.03 103 140 1747, GTV(916C) 1.8 16V(916C3) Coupe 05.98 106 144 1747, SPIDER(916S_) 1.8 16V(916C3) Convertible 05.98 106 144 1747, SPIDER(916S_) 2.0 T.SPARK 16V 06.95 110 150 1970, (916S2C00)Convertible;

FIAT: BRAVIA(182) 1.9 JTD Hatchback 09.00-10.01 74 100 1910, BRAVO(182) 1.9 JTD Hatchback 09.00-10.01 74 100 1910, MAREA(185) 2.0 150 20V Saloon 01.01 110 150 1998, MAREA Weekend(185) 2.0 150 20v Estate 01.01 110 150 1998, PUNTO(188) 1.9 JTD Hatchback 10.01 63 85 1910, PUNTO(188) 1.9 JTD 80(188,237,257,337,357) 09.99 59 80 1910, Hatchback, PUNTO Van(188AX) 1.9 JTD Box 02.00 63 86 1910;

LANCIA: LYBRA(839AX) 1.9 JTD Saloon 05.01 85 116 1910, LYBRA(839AX) 1.9 JTD(839AX1A) Saloon 09.00-05.01 81 110 1910, LYBRA(839AX) 2.020VJTD(839AXH1A)Saloon 09.00 110 150 1998, LYBRA(839AX) 2.4 JTD Saloon 05.02 110 150 2387, LYBRA(839AX) 2.4 JTD(839AXL1A) Saloon 09.00-05.02 103 140 2387, LYBRA SW (839BX) 1.9 JTD Estate 05.01 85 116 1910, LYBRA SW (839BX) 1.9 JTD(839BX1A) Estate 09.00-05.01 81 110 1910, LYBRA SW (839BX) 2.0 20V(839BXH1A)Estate 09.00 110 150 1998, LYBRA SW (839BX) 2.4 JTD Estate 05.02 110 150 2387, LYBRA SW (839BX) 2.4 JTD(839BXL1A) Estate 09.00 103 140 2387, THESIS (841AX) 2.4 (841AXB1B00)Saloon 07.02 125 170 2446, THESIS (841AX) 2.4JTD(841AXD1B02)Saloon 07.02 110 150 2387



GH5007

REPLACES / REEMPLAZA:

BOSCH: 0 281 002 429, 0 281 002 430; **VW:** 059 906 461 E, 059 906 461 EX

APPLICATION / APLICACIÓN:

AUDI: A4(8D2,B5) 2.5 TDI Saloon09.97-11.001101502496, A4(8D2,B5) 2.5 TDI Quattro Saloon09.97-11.001101502496, A4 Avant (8D5,B5) 2.5 TDI Estate09.97-09.011101502496, A4 Avant (8D5,B5) 2.5 TDI quattro Estate09.97-09.011101502496, A6(4B,C5) 2.5 TDI Saloon07.971101502496, A6(4B,C5) 2.5 TDI quattro Saloon07.971101502496, A6 Avant (4B,C5) 2.5 TDI Estate12.971101502496, A6 Avant (4B,C5) 2.5 TDI quattro Estate12.971101502496, A8(4D2,4D8) 2.5TDI Estate01.97-04.001101502496, A8(4D2,4D8) 2.5TDI quattro Estate 01.97-04.00 110 150 2496

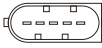

GH5008

REPLACES / REEMPLAZA:

BOSCH: 0 280 217 515, 0 280 217 516; **MERCEDES BENZ:** 112 094 0048

APPLICATION / APLICACIÓN:

MERCEDES BENZ: C-CLASS(W202) C 240(202,026)Saloon 06.97-05.00 125 170 2398, C-CLASS(W202) C 280(202,029)Saloon 06.97-05.00 145 197 2799, C-CLASS(W203) C 240(203,061)Saloon 05.00 125 170 2597, E C-CLASS(W203) C 240 4-Matic(203,081)S 07.02 125 170 2597, E C-CLASS(W203) C 320(203,064)Saloon 05.00 160 218 3199, E C-CLASS(W203)C320 4-Matic(203,081)Sal 07.02 160 218 3199, E C-CLASS Coupe(CL203) C320(203,764) 09.02 160 218 3199, E C-CLASS Estate(S202) C240 T(202,086) 06.97-09.00 125 170 2398, E C-class Estate(s202) c280T(202,089) 06.97-03.01 145 197 2799, E C-class T-model(S203) c240(203,261)Estate 03.01 125 170 2597, E C-class T-model(S203) c240 4-matic (203, 07.02 125 170 2597, 281)Estate , E c-class T-model(S203) C320(203,264)Estate 03.01 160 218 3199, E C-class T-model(S203) c320 4-matic (203, 07.02 160 218 3199, 284)Estate , E CLK(C208)320(208,386) Coupe 06.97-06.02 160 218 3199, E CLK(C209)240(209,361) Coupe 06.02 125 170 2597, E CLK(C209)320(209,365)Coupe 06.02 160 218 3199, E CLK Convertible(A208) 320(208,465) 03.98-03.02 160 218 3199, E CLK Convertible(A209) 240(208,461) 02.03 125 170 2597, E CLK Convertible(A209) 320(209,465) 02.03 160 218 3199, E E-CLASS(W210) E240(210,061)Saloon 06.97-08.00 125 170 2398, E E-CLASS(W210) E240(210,062)Saloon 08.00-03.02 125 170 2597, E E-CLASS(W210) E280(210,063)Saloon 12.96-03.02 150 204 2799, E E-CLASS(W210) E280 4-Matic(210,081)sal 12.96-03.02 150 204 2799, E E-CLASS(W210) E320(210,065)Saloon 06.97-03.02 165 224 3199, E E-CLASS(W210)E320 4-matic(210,082)Saloon 06.97-03.02 165 224 3199, E E-CLASS(W211)E240 (211,061)Saloon 03.02 130 177 2597, E E-class (W211)E240 4-matic(211,080)Saloon 03.03 130 177 2597, E E-CLASS(W211)E320 (211,065)Saloon 03.02 165 224 3199, E E-class (W211)E320 4-matic(211,082)Saloo 03.03 165 224 3199, E E-class Estate(S210) E240T(210,261) 06.97-03.03 125 170 2398, E E-class Estate(S210) E240T(210,262) 08.00-03.03 125 170 2597, E E-class Estate(S210) E280T(210,263) 12.96-03.03 150 204 2799, E E-class Estate(S210) E280T 4-matic(210, 12.96-03.03 150 204 2799, 281) , E E-class Estate(S210) E320T(210,265) 12.96-03.03 165 224 3199, E E-class Estate(S210) E320 T 4-Matic (210 12.96-03.03 165 224 3199, ,265) , E E-CLASS T-Model(S211) E 240 T (211,261) 03.03 130 177 2597, Estate , E E-CLASS T-Model(S211) E 240 T 4-Matic 07.03 130 177 2597, (211,280)ESTATE , E E-CLASS T-Model(S211) E 320 T (211,265) 03.03 165 224 3199, Estate , E E-CLASS T-Model(S211) E 320 T 4-Matic 07.03 165 224 3199, (211.282)ESTATE , E G-CLASS(W463) G 320(463,232,463,233) 07.97 158 215 3199, Closed Off-Road Vehicle , E G-CLASS Cabrio (W463) G 320(463,209) 11.97 158 215 3199, Open off-Road Vehicle , E M-CLASS(W163) ML320(163,154) 02.98-08.02 160 218 3199, Closed Off-Road Vehicle , E S-CLASS(W220) S 280(220,063,220,163) 10.98-08.05 150 204 2799, Saloon , E S-CLASS(W220) S 320(220,065,220,165) 10.98-08.05 165 224 3199, Saloon , E S-CLASS(W220) S350(220,067,220,167) 09.02-08.05 180 245 3724, Saloon , E S-CLASS(W220) S350 4-matic (220,087 06.03-08.05 180 245 3724, 220,187) Saloon , E SL(R129) 280 (129,059) Convertible 05.98-10.01 150 204 2799, E SL(R129) 320 (129,064) Convertible 05.98-10.01 165 224 3199, E SL(R230) 350(230,467) Convertible 03.03 180 245 3724, E SLK(R170) 320 (170,465) Convertible 03.00-04.04 160 218 3199, E VIANO(W639) 3.2 MPV 09.03 160 218 3199, E VIANO(W639) 3.2 MPV 09.03 140 190 3199, E VIANO(W639) 3.7 MPV 06.04 170 231 3724, E VITO Box(W639) 119 3.2 Box 09.03 140 190 3199, E VITO Box(W639) 122 3.2 Box 09.03 160 218 3199, E VITO Bus(W639) 119 09.03 140 190 3199, E VITO Bus(W639) 122 09.03 160 218 3199, E VITO Bus(W639) 123 06.04 170 231 3724



GH5009

REPLACES / REEMPLAZA:

BOSCH: 0 281 002 428; **OPEL:** 90 195 729, 93 171 355, 24 414 665, 08 36 591

APPLICATION / APLICACIÓN:

OPEL: ASTRA G Estate(F35_) 2.0 DTI 16V 08.99 74 101 1995, ASTRA G Hatchback(F48_F08_) 2.0 DTI 16V 08.99 74 10 1995, ASTRA G Saloon(F69_) 2.0 DTI 16V 08.99 74 10 1995, OMEGA B(25_26_27_) 2.2DTI 16V Saloon 09.00-07.03 88 120 2171, OMEGA B(21_22_23_) 2.2DTI 16V Estate 09.00-07.03 88 120 2171, VECTRA B (36_) 2.2 DTI 16V Saloon 09.00-04.02 92 125 2171, VECTRA B (31_) 2.0 DTI 16V Estate 09.00-07.03 74 101 1995, VECTRA B (31_) 2.2 DTI 16V Estate 09.00-07.03 92 125 2172, VECTRA B (38_) 2.0 DTI 16V Hatchback 06.97-07.03 74 101 1995, VECTRA B (38_) 2.0 DTI 16V Hatchback 09.00-07.03 92 125 2172, ZAFIRA(F75_) 2.0 DI 16V MPV 10.99 60 82 1995, ZAFIRA(F75_) 2.0 DTI 16V MPV 09.00 74 101 1995;

VAUXH: ASTRA Mk IV 2.0 DI Saloon 09.98 60 82 1995, ASTRA Mk IV 2.0 DTI 16V Saloon 08.99 74 101 1995, ASTRA Mk IV 2.0 DI Estate 02.98 60 82 1995, ASTRA Mk IV 2.0 DTI Estate 08.99 74 101 1995, ASTRA Mk IV 2.0 DI Hatchback 02.98 60 82 1995, ASTRA Mk IV 2.0 DTI 16V Hatchback 08.99 74 101 1995, ASTRAVAN Mk IV 2.0 DI Box 08.98 60 82 1995, ASTRAVAN Mk IV 2.0 DTI Box 04.04 74 100 1995, OMEGA 2.2 DTI 16V Saloon 09.00 88 120 2171, OMEGA 2.2 DTI 16V Estate 09.00 88 120 2171, VECTRA 2.0 DTI 16V Saloon 06.97 74 101 1995, VECTRA 2.2 DTI 16V Saloon 09.00 92 125 2172, VECTRA 2.0 DTI 16V Hatchback 06.97 74 101 1995, VECTRA 2.2 DTI 16V Hatchback 09.00 92 125 2172, ZAFIRA 2.0 DI 16V MPV 10.99 60 82 1995, ZAFIRA 2.0 DTI 16V MPV 04.99 74 101 1995



GH5010

REPLACES / REEMPLAZA:

BOSCH: 0 280 218 004; **FIAT:** 46 533 308; **LADA:** 21083-1130010-01

APPLICATION / APLICACIÓN:

FIAT: MAREA (185) 2.4JTD 130 Saloon 04.99 96 130 2387, MAREA Weekend(185) 2.4JTD 130 Estate 04.99 96 130 2387, MULTIPLA(186) 1.9 JTD 105(186AXB1A)MPV 04.99 77 105 1910;

LADA: 110 1.5 Saloon 01.95 57 78 1499, 110 1.5 Saloon 01.95 57 78 1499, 110 1.5 16V Saloon 01.95 70 95 1499, 111 1.5 Estate 01.96 57 78 1499, 111 1.5 16V Estate 01.95 70 95 1499, 112 1.5 Hatchback 01.95 57 78 1499, 112 1.5 Hatchback 01.95 54 73 1500, 112 1.5 16V Hatchback 01.95 70 95 1500, NIVA (2121) 1700 I Closed Offroad Vehicle 06.96 59 80 1690, SAMARA(2108,2109)1300 Hatchback 02.96 50 68 1288, SAMARA(2108,2109)1500 Hatchback 01.88 53 72 1499, SAMARA(2108,2109)1500 Hatchback 02.95 52 71 1499, SAMARA FORMA(21099)1500 Saloon 07.91 50 68 1500, SAMARA FORMA(21099)1500 Saloon 11.94 52 71 1499



GH5011

REPLACES / REEMPLAZA:

SIEMENS: 5WK9611, 5WK9612, 5WK9150; HELLA: 8ET 009 142-081; OPEL: 836 569, 90 411 957; DAEWOO: 96 184 230

APPLICATION / APLICACIÓN:

OPEL: ASTRA F(56_57_) 1.8 I 16V Saloon 06.93-10.94 92 125 1799, ASTRA F(56_57_) 1.8 I 16V Saloon 11.94-09.98 85 116 1799, ASTRA F(56_57_) 2.0 I 16V Saloon 02.95-09.98 100 136 1998, ASTRA F Convertible(53_B) 1.8i 16v 11.94-03.01 85 116 1799, ASTRA F Estate(51_52_) 1.8 I 16V 07.94-01.98 85 116 1799, ASTRA F Estate(51_52_) 1.8 I 16V 06.93-01.98 92 125 1799, ASTRA F Estate(51_52_) 2.0 I 16V 02.95-01.98 100 136 1998, ASTRA F(53_54_58_59_) 1.8 I 16V Hatch 09.94-01.98 85 116 1799, ASTRA F(53_54_58_59_) 1.8 I 16V Hatch 06.93-08.94 92 125 1799, ASTRA F(53_54_58_59_) 2.0 I 16V Hatch 02.95-01.98 100 136 1998, CALIBRA A(85_) 2.0 I 16V Coupe 02.94-07.97 100 136 1998, CALIBRA A(85_) 2.0 I 16V 4X4 Coupe 02.94-07.97 100 136 1998, CALIBRA A(85_) 2.0 I 4X4 Coupe 06.90-07.97 85 115 1998, OMEGA B(25_26_27_) 2.0 I 16V Saloon 03.94-09.99 100 136 1998, OMEGA B(21_22_23_) 2.0 I 16V Estate 03.94-09.99 100 136 1998, VECTRA A(86_87_) 2.0 I 16V Saloon 06.94-11.95 100 136 1998, VECTRA A(86_87_) 2.0 I 16V 4X4 Saloon 06.94-11.95 100 136 1998, VECTRA A Hatchback(88_89_20i) 16v 06.94-11.95 100 135 1998, VECTRA B(36_) 1.8 I 16V Saloon 10.95-09.00 85 115 1796, VECTRA B(36_) 2.0 I 16V Saloon 10.95-09.00 100 136 1998, VECTRA B Estate(31_) 1.8 I 16V 11.96-09.00 85 115 1796, VECTRA B Estate(31_) 2.0 I 16V 11.96-09.00 100 136 1998, VECTRA B Estate(38_) 1.8 I 16V 10.95-09.00 85 116 1796, VECTRA B Estate(38_) 2.0 I 16V 10.95-09.00 100 136 1998;

VAUXH: ASTRA Mk III 1.8 I 16V Saloon 01.94-12.96 85 115 1796, ASTRA Mk III 1.8 I 16V Saloon 06.93-10.94 92 125 1799, ASTRA Mk III 2.0 I 16V Saloon 02.95-09.98 100 136 1799, ASTRA Mk III 1.8 I 16V Convertible 11.94-03.01 85 116 1799, ASTRA Mk III 1.8 I 16V Estate 09.94-02.98 85 115 1796, ASTRA Mk III 1.8 I 16V Estate 09.94-02.98 92 125 1796, ASTRA Mk III 2.0 I 16V Estate 01.94-02.98 100 136 1998, ASTRA Mk III 1.8 I 16V Hatchback

GH5012

REPLACES / REEMPLAZA:

SIEMENS: 5WK964; HELLA: 8ET 009 142-03; OPEL: 836 583, 90 530 463

APPLICATION / APLICACIÓN:

OPEL: ASTRA G Convertible 1.8 I 16V 03.01 92 125 1796, ASTRA G Coupe(F07_) 1.8 I 16V 03.00-10.00 85 116 1796, ASTRA G Coupe(F07_) 1.8 I 16V 09.00 92 125 1796, ASTRA G Estate(F35_) 1.8 I 16V 09.00 92 125 1796, ASTRA G Estate(F35_) 1.8 I 16V 02.98-09.00 85 116 1796, ASTRA G Estate(F35_) 2.0 I 16V 02.98 100 136 1998, ASTRA G Hatchback(F48_F08_) 1.8 I 16V 02.98-09.00 85 116 1796, ASTRA G Hatchback(F48_F08_) 1.8 I 16V 09.00 92 125 1796, ASTRA G Hatchback(F48_F08_) 2.0 I 16V 02.98 100 136 1998, ASTRA G Hatchback(F48_F08_) 2.0 I 16V OPC 11.98-09.02 118 160 1998, ASTRA G Saloon(F69_) 1.8 I 16V 09.00 92 125 1796, ASTRA G Saloon(F69_) 1.8 I 16V 09.98-09.00 85 116 1796, ASTRA G Saloon(F69_) 2.0 I 16V 09.98 100 136 1998, ASTRA H 1.8 I 03.04 92 125 1796, ASTRA H Estate 1.8 I 08.04 92 125 1796, CORSA C(F08_F68) 1.8 Hatchback 09.00 92 125 1796, MERIVA 1.8 I 05.03 92 125 1796, OMEGA B(25_26_27_) 2.2 I 16V Saloon 09.99-07.03 106 144 2198, OMEGA B(25_26_27_) 2.2 I 16V Estate 09.99-07.03 106 144 2198, SIGNUM 1.8 Hatchback 05.03 90 122 1796, TIGRA Twin Top 1.8 Convertible 06.04 92 125 1796, VECTRA B(36_) 1.8 I 16V Saloon 10.95-09.00 85 115 1796, VECTRA B(36_) 1.8 I 16V Saloon 09.00-04.02 92 125 1796, VECTRA B(31_) 1.8 I 16V Estate 11.96-09.00 85 115 1796, VECTRA B(31_) 1.8 I 16V Estate 09.00-07.03 92 125 1796, VECTRA B hatchback(38_) 1.8 I 16V 10.95-09.00 85 116 1796, VECTRA B hatchback(38_) 1.8 I 16V 09.00-07.03 92 125 1796, VECTRA C 1.8 I 16V Saloon 04.02 90 122 1796, VECTRA C GTS 1.8 I 16V Hatchback 08.02 90 122 1796, ZAFIRA(F75_) 1.8 I 16V MPV 09.00 92 125 1796, ZAFIRA(F75_) 1.8 I 16V MPV 04.99-09.00 85 116 1796;

VAUXH: ASTRA MK IV Convertible 1.8 I 16V 03.01 92 125 1796, ASTRA MK IV 1.8 I 16V Saloon 09.00 92 125 1796, ASTRA MK IV 1.8 I 16V Saloon 09.98-09.00 85 116 1796, ASTRA MK IV 2.0 I 16V Saloon 08.98 100 136 1998, ASTRA MK IV Coupe 1.8 I 16V 09.00 92 125 1796, ASTRA MK IV Coupe 1.8 I 16V 03.00-10.00 85 115 1796, ASTRA MK IV Estate 1.8 I 16V 02.98-09.00 85 116 1796, ASTRA MK IV Estate 1.8 I 16V 09.00 92 125 1796, ASTRA MK IV Estate 2.0 I 16V 02.98 100 136 1998, ASTRA MK IV Hatchback 1.8 I 16V 02.98-09.00 85 116 1796, ASTRA MK IV Hatchback 1.8 I 16V 09.00 92 125 1796, ASTRA MK IV Hatchback 2.0 I 16V 02.98 100 136 1998, ASTRA MK II Hatchback 1.8 I 16V 09.00 92 125 1796, MERIVA 1.8 I 16V MPV 05.03 92 125 1796, OMEGA 2.2 I 16V Saloon 09.99 106 144 2198, OMEGA Estate 2.2 I 16V 09.99 106 144 2198, TIGRA Twin Top 1.8 convertible 06.04 92 125 1796, VECTRA 1.8 I 16V Saloon 09.00 92 125 1796, VECTRA 1.8 I 16V Saloon 10.95-09.00 85 116 1796, VECTRA Estate 1.8 I 16V 11.96-09.00 85 115 1796, VECTRA Estate 1.8 I 16V 09.00 92 125 1796, VECTRA Hatchback 1.8 I 16V 10.95-09.00 85 116 1796, VECTRA Hatchback 1.8 I 16V 09.00 92 125 1796, VECTRA Mk II 1.8 I 16V Saloon 04.02 90 122 1796, VECTRA Mk II GTS 1.8 I 16V Hatchback 08.02 90 122 1796, ZAFIRA 1.8 I 16V MPV 09.00 92 125 1796, ZAFIRA 1.8 I 16V MPV 04.99-09.00 85 116 1796



GH5013

REPLACES / REEMPLAZA:

BOSCH: 0 280 218 013; VW: 06B 133 471

APPLICATION / APLICACIÓN:

AUDI: A4 (8D2,B5) 1.8 Saloon 01.95-11.00 92 125 1781, A4 (8D2,B5) 1.8 quattro Saloon 01.95-11.00 92 125 1781, A4 Avant (8D5,B5) 1.8 Estate 02.96-09.01 92 125 1781, A4 Avant (8D5,B5) 1.8 quattro Estate 01.96-09.01 92 125 1781, A6(4B,C5) 1.8 Saloon 07.97 92 125 1781, A6 Avant (4B,C5) 1.8 Estate 12.97 92 125 1781, VW: PASSAT (3B2) 1.8 Saloon 10.96-11.00 92 125 1781, PASSAT (3B2) 1.8 Syncro/4 motion Saloon 10.96-11.00 92 125 1781, PASSAT Variant(3B5) 1.8 Estate 06.97-11.00 92 125 1781, PASSAT Variant(3B5) 1.8 Syncro/4motion Estate 06.97-11.00 92 125 1781



GH5014

REPLACES / REEMPLAZA:

BOSCH : 0 280 218 060; VW: 06A 906 461G

APPLICATION / APLICACIÓN:

AUDI: A3(8L1) 1.8 Hatchback 09.96 92 125 1781;

SEAT: ALHAMBRA(7V8,7V9) 1.8 T 20V 10.97 110 150 1781, ALHAMBRA(7V8,7V9) 2.0 I MPV 04.96 85 115 1984, CORDOBA(6L2) 2.0 Saloon 09.02 85 115 1984, LEON(1M1) 1.8 20V Hatchback 11.99 92 125 1781, TOLEDO II(1M2) 1.8 20V 04.99 92 125 1781;

SKODA: FABIA (6Y2) 2.0 Hatchback 12.99 85 116 1984, FABIA combi(6Y5) 2.0 Estate 04.00 85 116 1984, FABIA Saloon(6Y3) 2.0 Saloon 12.99 85 116 1984, OCTAVIA Combi(1U5) 2.0 4X4 05.01 85 116 1984;

VW: BORA (1J2) 1.6 06.02-10.04 78 107 1595, BORA (1J2) 1.6 FSI 01.02 81 110 1598, BORA (1J2) 2.0 10.98 85 115 1984, BORA (1J2) 2.0 4motion 04.00 85 115 1984, BORA Estate(1J6) 1.6 FSI 01.02 81 110 1598, BORA Estate(1J6) 2.0 Estate 05.99 85 115 1984, BORA Estate(1J6) 2.0 4motion Estate 04.00 85 115 1984, GOLF IV (1J1) 1.6 16V Hatchback 08.03-06.05 78 107 1595, GOLF IV (1J1) 1.6 FSI Hatchback 01.02 81 110 1598, GOLF IV (1J1) 2.0 Hatchback 07.98 85 115 1984, GOLF IV (1J1) 2.0 4motion Hatchback 10.00 85 115 1984, GOLF IV Variant(1J5) 1.6 FSI 01.02 81 110 1598, GOLF IV Variant(1J5) 2.0 Estate 05.99 85 115 1984, GOLF IV Variant(1J5) 2.0 4motion Estate 10.00 85 115 1984, GOLF IV Variant(1J5) 2.0 Bi-Fuel 02.02 85 116 1984, MULTIVAN(7HM)2.0 MPV 04.03 85 116 1984, NEW BEETLE(9C1,1C1) 2.0 Hatchback 01.98 85 115 1984, NEW BEETLE conv. (1Y7) 2.0 01.03 85 115 1984, PHAETON(3D2) 4.2 V8 4motion 05.03 246 335 4172, SHARAN(7M8,7M9,7M6) 1.8 T 2.0 V MPV 09.97 110 150 1781, SHARAN(7M8,7M9,7M6) 2.0 V MPV 09.95 85 115 1984, TOUAREG(7LA) 4.2 V8 12.02 228 310 4172, TRANSPORTER V Box(7HA,7HH) 2.0 04.03 85 115 1984, TRANSPORTER V Bus(7HA,7HH) 2.0 04.03 85 115 1984, TRANSPORTER V Flabted/Chasis(7JD,7JE 04.03 85 115 1984, 7JL) 2.0





GH5015

REPLACES / REEMPLAZA:

BOSCH: 0 280 218 063; **VW:** 06A 906 461L

APPLICATION / APLICACIÓN:

AUDI: A4 Avant(8E5,B6) 1.8 T Estate 09.01-07.02 110 150 1781, A6 Avant(4B,C5) 1.8 quattro Estate 12.97 110 150 1781, A3(8L1) 1.8 T quattro Hatchback 10.98 132 180 1781, A3(8L1) 1.8 T Hatchback 12.96 110 150 1781, A3(8L1) 1.8 T Hatchback 12.98 132 180 1781, A3(8L1) 1.8 T quattro Hatchback 12.96 110 150 1781, A4(8D2,B5) 1.8 T quattro Saloon 01.95-11.00 110 150 1781, A4(8D2,B5) 1.8 T Saloon Saloon 01.95-11.00 110 150 1781, A4(8EC) 1.8 T quattro Saloon 11.04 120 163 1781, A4(8EC) 1.8 T Saloon 11.04 120 163 1781, A4 Avant(8D5,B5) 1.8 T Estate 03.96-09.01 110 150 1781, A4 Avant(8D5,B5) 1.8 T quattro Estate 01.96-09.01 110 150 1781, A4 Avant(8E5,B6) 1.8 T Estate 11.02 140 190 1781, A4 Avant(8E5,B6) 1.8 T quattro 07.02 120 163 1781, A4 Avant(8E5,B6) 1.8 T quattro Estate 11.02 140 190 1781, A4 Avant(8E5,B6) 1.8 T Saloon 07.02 120 163 1781, A4 Avant(8ED) 1.8 T Estate 11.04 120 163 1781, A4 Avant(8ED) 1.8 T quattro Estate 11.04 120 163 1781, A4 convertible(8H7) 1.8 T 07.02 120 163 1781, A4 Convertible(8H7) 1.8 T quattro 05.03 120 163 1781, A4(8E2,B6) 1.8 T 11.00-07.02 110 150 1781, A4(8E2,B6) 1.8 T quattro 11.00-07.02 110 150 1781, A4(8E2,B6) 1.8 T quattro 11.02 140 190 1781, A4(8E2,B6) 1.8 T quattro Saloon 07.02 120 163 1781, A4(8E2,B6) 1.8 T Saloon 07.02 120 163 1781, A4(8E2,B6) 1.8 T Saloon 11.02 140 190 1781, A4(8EC) 1.8 T Saloon 11.04 120 163 1781, A6 Avant(4B,C5) 1.8 T 12.97 110 150 1781, A6(4B,C5) 1.8 T quattro Saloon 02.97 110 150 1781, A6(4B,C5) 1.8 T Saloon 01.97 110 150 1781, TT(8N3) 1.8 T Coupe 10.98 132 180 1781, TT(8N3) 1.8 T quattro Coupe 10.98 132 180 1781, TT Roadster(8N9) 1.8 T Convertible 10.99 132 180 1781, TT Roadster(8N9) 1.8 T Convertible 01.01 110 150 1781, TT Roadster(8N9) 1.8 T quattro Convertible 02.00 132 180 1781, TT(8N3) 1.8 T Coupe 09.02 110 150 1781;

SEAT: IBIZA IV(6L1) 1.8 T Cupra R Hatchback 01.04 132 180 1781, IBIZA IV(6L1) 1.8 T FR 12.03 110 160 1781, LEON(1M1) 1.8 20V T4 Hatchback 11.99 132 180 1781, LEON(1M1) 1.8 20V T Hatchback 11.99 132 180 1781, TOLEDO II(1M2) 1.8 20VT 05.01 132 180 1781;

SKODA: OCTAVIA(1U2) 1.8 T 4X4 05.01 110 150 1781, OCTAVIA Combi(1U5) 1.8 T 07.98 110 150 1781, OCTAVIA Combi(1U5) 1.8 T 4X4 05.01 110 150 1781, OCTAVIA Combi(1U5) RS 1.8 T 08.02 132 180 1781, OCTAVIA(1U2) 1.8 T Hatchback 08.97 110 150 1781, OCTAVIA(1U2) RS 1.8 T Hatchback 05.01 132 180 1781;

VW: BORA(1J2) 1.8 T Saloon 05.00 110 150 1781, BORA(1J2) 1.8 T Saloon 03.02 132 180 1781, BORA Estate(1J6) 1.8 Estate 05.00 110 150 1781, BORA Estate(1J6) 1.8 Estate 05.02 132 180 1781, GOLF IV(1J1) 1.8 T GTI 08.01 132 180 1781, GOLF IV Variant(1J5) 1.8 T Estate 05.00 110 150 1781, GOLF IV(1J1) 1.8 T Hatchback 08.97 110 150 1781, NEW BEELTE(9C1,C1) 1.8 T Hatchback 10.99 110 150 1781, NEW BEELTE Convertible(1Y7) 1.8T 01.04 110 150 1781, PASSAT Variant(3B6) 1.8 T 20 V 11.00 110 150 1781, PASSAT(3B3) 1.8 T 20V Saloon 11.00 110 150 1781, POLO(9N_) 1.8 GTI Hatchback 09.05 110 150 1781

GH5016

REPLACES / REEMPLAZA:

BOSCH: 0 280 217 114, 0 280 217 115; **MERCEDES BENZ:** 000 094 09 48

APPLICATION / APLICACIÓN:

MERCEDES BENZ: C-CLASS(W202) C 180 (202.018) Saloon 11.94-05.00 89 121 1799, C-CLASS(W202) C 180 (202.018) Saloon 03.93-05.00 90 122 1799, C-CLASS(W202) C 200 (202.020) Saloon 01.94-05.00 100 136 1998, C-CLASS(W202) C 200 CDI(202.134) Saloon 03.98-05.00 75 102 2151, C-CLASS(W202) C 200 Kompressor 11.96-05.00 141 192 1998, (202.134) Saloon, C-CLASS(W202) C 200 Kompressor 10.95-05.00 132 180 1998, (202.134) Saloon, C-CLASS(W202) C 220 CDI(202.133) Saloon 09.97-05.00 92 125 2151, C-CLASS(W202) C 230(202.023) Saloon 06.96-06.97 110 150 2295, C-CLASS(W202) C 230Kompressor(202.024) 10.95-05.00 142 193 2295, C-CLASS(W202)C250Turbo-D(202.128)saloon 10.95-05.00 110 150 2497, C-CLASS Estate (S202) C 180 T(202.078) 06.96-09.00 90 122 1799, C-CLASS Estate (S202) C 200 T(202.080) 06.96-03.01 100 136 1998, C-CLASS Estate (S202) C 200 T CDI(202.1940 03.98-03.01 75 102 2151, C-CLASS Estate (S202) C 200 T Kompressor 11.96-03.01 141 192 1998, 202.082), C-CLASS Estate(S202) C 220 T CDI(202.09.97-03.01 92 125 2151, 193), C-CLASS Estate(S202) C 230 T(202.083) 06.96-06.98 110 150 2295, C-CLASS Estate(S202) C 230 T Kompressor 06.97-09.00 142 193 2295, 202.085), C-CLASS Estate(S202) C 250 turbo-D 06.96-03.01 110 150 2497, 202.188), CLK(C208) 200 (208.335) Coupe 06.97-06.02 100 136 1998, CLK(C208) 200 Kompressor(208.345) 06.97-06.00 141 192 1998, CLK(C208) 230 Kompressor(208.347) 06.97-06.00 142 193 2295, CLK Convertible(A208) 200 (208.435) 03.98-03.02 100 136 1998, CLK Convertible(A208) 200 Kompressor(03.98-06.00 141 192 1998, 208.445), CLK Convertible(A208) 230 Kompressor(03.98-06.00 142 193 2295, 208.447), E-CLASS (W210) E 200 (210.035) 06.95-08.00 100 136 1998, E-CLASS (W210) E 200 Kompressor 06.97-03.02 137 186 1998, 210.045), E-CLASS (W210) E 230(210.037) 06.95-06.97 110 150 2295, E-CLASS Estate(S210) E 200 T (210.235) 06.96-08.00 100 136 1998, E-CLASS Estate(S210) E 200 T Kompressor 06.97-03.03 137 186 1998, 210.245), E-CLASS Estate(S210) E 230 T(210.237) 06.96-06.97 110 150 2295, M-CLASS (W163) ML 230(163.136) 02.98-06.05 110 150 2295, SLK(R170) 200 (170.435) convertible 09.96-03.00 100 136 1998, SLK(R170) 200 Kompressor(170.445) 10.96-03.00 141 192 1998, convertible, SLK(R170) 230 Kompressor(170.447) 09.96-03.00 142 193 2295, convertible, V-CLASS(638/2) V 200 CDI(638.294) MPV 03.99 75 102 2148, V-CLASS(638/2) V 220 CDI(638.294) MPV 03.99 90 122 2148, VITO Box(638) 108 CDI 2.2 03.99 60 82 2151, VITO Box(638) 110 CDI 2.2 03.99 75 102 2151, VITO Box(638) 112 CDI 2.2 03.99 90 122 2151, VITO Bus(638) 108 CDI 2.2 03.99 60 82 2148, VITO Bus(638) 110 CDI 2.2 03.99 75 105 2148, VITO Bus(638) 112 CDI 2.2 03.99 90 122 2148

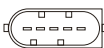

GH5018

REPLACES / REEMPLAZA:

BOSCH: 0 280 217 124; **BMW:** 13 62 1 433 565

APPLICATION / APLICACIÓN:

BMW: 3 (E46) 316 I Saloon 09.98-02.05 77KW 105HP 1895CC, 3 (E46) 316 I Saloon 04.00-02.05 77KW 105HP 1596CC, 3 (E46) 318 I Saloon 02.98-09.01 87KW 118HP 1895CC, 3 compact (E36) 316 I Hatchback 12.98-08.00 77KW 105HP 1895CC, 3 Coupe (E46) 316 Ci 04.00 77KW 105HP 1596CC, 3 Coupe (E46) 318 Ci 11.99-09.01 87KW 118HP 1895CC, 3 Touring (E46) 318 Ci Estate 10.99-09.01 87KW 118HP 1895CC, 7 (E38) 740 d Saloon 05.99-11.01 180KW 245HP 3901CC, Z3 1.9 Convertible 07.98 87KW 118HP 1895CC

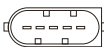

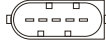

GH5017

REPLACES / REEMPLAZA:

BOSCH: 0 280 217 517; **MERCEDES:** 000 094 1048; **SSANGYONG:** 000 094 0548

APPLICATION / APLICACIÓN:

MERCEDES: C-CLASS(W202) C 280 (202.028) Saloon 05.93-05.00 142KW 193HP 2799CC, C-CLASS(W202) C 36 AMG(202.028) Saloon 05.94-05.00 206KW 280HP 3606CC, S-CLASS(W140) 300 SE 2.8(140.028) Saloon 01.93-10.98 145KW 197HP 2799CC, S-CLASS(W140) 300 SE,SEL/320(140.032,140.033) Saloon 03.91-10.98 170KW 231HP 3199CC, S-CALSS(W140) S 280(140.028) Saloon 02.93-10.98 142KW 193HP 2799CC, SL(R129) 280(129.058) Convertible 08.93-10.01 142KW 193HP 2799CC, SL(R129) 280(129.063) Convertible 09.93-10.01 170KW 231HP 3199CC, SPRINGTER 2-t Box(901.902) 208 CDI 04.00-05.06 60KW 82HP 2148CC, SPRINGTER 2-t Box(901.902) 211 CDI 04.00-05.06 80KW 109HP 2148CC, SPRINGTER 2-t Box(901.902) 213 CDI 04.00-05.06 95KW 129HP 2148CC, SPRINGTER 2-t Box(901.902) 216 CDI 04.00-05.06 115KW 156HP 2685CC, SPRINGTER 2-t Flatbed /Chassis(901.902) 208 CDI 04.00-05.06 60KW 82HP 2148CC, SPRINGTER 2-t Flatbed /Chassis(901.902) 211 CDI 04.00-05.06 80KW 109HP 2148CC, SPRINGTER 2-t Flatbed /Chassis(901.902) 213 CDI 04.00-05.06 95KW 129HP 2148CC, SPRINGTER 2-t Flatbed /Chassis(901.902) 216 CDI 04.00-05.06 115KW 156HP 2685CC, SPRINGTER 3-t Box(903) 308 CDI 04.00-05.06 60KW 82HP 2148CC, SPRINGTER 3-t Box(903) 311 CDI 04.00-05.06 80KW 109HP 2148CC, SPRINGTER 3-t Box(903) 313 CDI 04.00-05.06 95KW 129HP 2148CC, SPRINGTER 3-t Box(903) 313 CDI 4X4 08.02-05.06 80KW 109HP 2148CC, SPRINGTER 3-t Box(903) 316 CDI 04.00-05.06 115KW 156HP 2685CC, SPRINGTER 3-t Box(903) 316 CDI 4X4 08.02-05.06 115KW 156HP 2685CC, SPRINGTER 3-t Box(903) 308 CDI 04.00-05.06 60KW 82HP 2148CC, SPRINGTER 3-t Box(903) 311 CDI 04.00-05.06 80KW 109HP 2148CC, SPRINGTER 3-t Bus (903) 313 CDI 4X4 08.02-05.06 95KW 129HP 2148CC, SPRINGTER 3-t Bus (903) 313 CDI 4x4 08.02-05.06 95KW 129HP 2148CC, SPRINGTER 3-t Bus (903) 316 CDI 04.00-05.06 115KW 156HP 2685CC, SPRINGTER 3-t Bus(903) 315 CDI 4X4 08.02-05.06 115KW 156HP 2685CC, SPRINGTER 3-t Flatbed/Chassis(903) 308CDI 04.00-05.06 60KW 82HP 2148CC, SPRINGTER 3-t Flatbed/Chassis(903) 311CDI 04.00-05.06 80KW 109HP 2148CC, SPRINGTER 3-t Flatbed/Chassis(903)311CDI 4X4 08.02-05.06 80KW 109HP 2148CC, SPRINGTER 3-t Flatbed/Chassis(903) 313CDI 04.00-05.06 95KW 129HP 2148CC, SPRINGTER 3-t Flatbed/Chassis(903) 313CDI 4X4 08.02-05.06 95KW 129HP 2148CC, SPRINGTER 3-t Flatbed/Chassis(903)316CDI 04.00-05.06 115KW 156HP 2685CC, SPRINGTER 3-t Flatbed/Chassis(903)316CDI 4X4 08.02-05.06 115KW 156HP 2685CC, SPRINGTER 4-t Box(904) 408 CDI 04.00-05.06 60KW 82HP 2148CC, SPRINGTER 4-t Box(904) 411 CDI 04.00-05.06 80KW 109HP 2148CC, SPRINGTER 4-t Box(904) 411 CDI 4X4 04.00-05.06 80KW 109HP 2148CC, SPRINGTER 4-t Box(904) 413 CDI 04.00-05.06 95KW 129HP 2148CC, SPRINGTER 4-t Box(904) 413 CDI 4x4 04.00-05.06 95KW 129HP 2148CC, SPRINGTER 4-t Box(904) 416 CDI 04.00-05.06 115KW 156HP 2685CC, SPRINGTER 4-t Bus(904) 408 CDI 04.00-05.06 60KW 82HP 2148CC, SPRINGTER 4-t Bus(904) 411 CDI 04.00-05.06 80KW 109HP 2148CC, SPRINGTER 4-t Bus(904) 413 CDI 04.00-05.06 95KW 129HP 2148CC, SPRINGTER 4-t Bus(904) 416 CDI 04.00-05.06 115KW 156HP 2148CC, SPRINGTER 4-t Flatbed/Chassis(904) 408cdi 04.00-05.06 60KW 82HP 2148CC, SPRINGTER 4-t Flatbed/Chassis(904) 411cdi 04.00-05.06 80KW 109HP 2148CC, SPRINGTER 4-t Flatbed/Chassis(904) 411cdi 4X4 04.00-05.06 80KW 109HP 2148CC, SPRINGTER 4-t Flatbed/Chassis(904) 413cdi 04.00-05.06 95KW 129HP 2148CC, SPRINGTER 4-t Flatbed/Chassis(904) 413cdi 4X4 04.00-05.06 95KW 129HP 2148CC, SPRINGTER 4-t Flatbed/Chassis(904) 416cdi 04.00-05.06 115KW 156HP 2685CC, SPRINGTER 4-t Flatbed/Chassis(904) 416cdi 4X4 04.00-05.06 115KW 156HP 2685CC, SPRING 616 CDI Dump Truck 04.01 115KW 156HP 2685CC, SPRING 616 CDI Platform/Chassis 04.01 115KW 156HP 2685CC; **SSANG:** MUSSO(FJ) 3.2 Closed off Road Vehicle 06.96 162KW 220HP 3199CC



GH5019

REPLACES / REEMPLAZA:

BOSCH: 0 280 217 100; **MERCEDES:** 000 094 00 48; **SSANGYONG:** 000 094 00 48

APPLICATION / APLICACIÓN:

MERCEDES: C-CLASS (W202) C 180 (202.018) Saloon 03.93-05.00 90 122 1799, C-CLASS (W202) C 200 (202.020) Saloon 01.94-05.00 100 136 1998, C-CLASS (W202) C 220 (202.022) Saloon 03.95-05.00 110 160 2199, C-CLASS (S202) C 180 T(202.078) Estate 06.96-09.00 90 122 1799, C-CLASS (S202) C 200 T(202.080) Estate 06.96-03.01 100 136 1998, COUPE (C124) 220 CE (124.042) 10.92-05.93 110 150 2199, E-CLASS(W124) E 220(124.022) Saloon 06.93-06.95 110 150 2199, E-CLASS(W210) E 230(124.037) Saloon 06.95-06.97 110 150 2295, E-CALSS Convertible (A124) E 220 (124.062) 06.93-03.98 110 150 2199, E-CLASS Coupe (124) E 220(124.042) 06.93-06.97 110 150 2199, E-CLASS Estate(S124) E 220 T(124.082) 06.93-06.96 110 150 2199, E-CLASS Estate(S210) E 230 T(210,237) 06.96-06.97 110 150 2295, KOMBI Estate (S124) 220 TE(124.082) 10.92-05.93 110 150 2199, Saloon(W124) 220 E(124.022) 10.92-06.93 110 150 2199;

SSANG: KORANDO (KJ) 2.0 Closed off road Vehicle 05.97 94 128 1998, KORANDO(KJ) 2.3 Closed off road Vehicle 05.97 103 140 2295, KORANDO(KJ) 2.3 Closed off road Vehicle 01.99 105 143 2295, KORANDO Cabrio(KJ)2.3 Closed off road Vehicle 02.99 105 143 2295, KORANDO Cabrio(KJ)2.3 Closed off road Vehicle 11.97 103 140 2295, MUSSO (FJ) 2.0Close off road Vehicle 10.96 93 126 1998, MUSSO (FJ) 2.3Close off road Vehicle 10.96 103 140 2295, MUSSO (FJ) 2.3Close off road Vehicle 04.03 110 150 2295



GH5020

REPLACES / REEMPLAZA:

BOSCH: 0 280 217 500; **MERCEDES:** 000 094 05 48

APPLICATION / APLICACIÓN:

MERCEDES: C-CLASS (W202) C 280 (202.028) Saloon 05.93-05.00 142 193 2799, C-CLASS (W202) C 36 AMG (202.028) Saloon 05.94-05.00 206 280 3606, COUPE (C124) 320 CE (124.052) 10.92-05.93 162 220 3199, E-CLASS(W124) E 280 (124.028) Saloon 06.93-06.95 145 197 2799, E-CLASS(W124) E 280 long (124.029) Saloon 06.93-06.95 142 193 2799, E-CLASS(W124) E 320 (124.032) Saloon 06.93-06.95 162 220 3199, E-CLASS(W210) E 280 (210.053) Saloon 01.96-06.97 142 193 2799, E-CLASS(W210) E 320 (210.055) Saloon 06.95-06.97 162 220 3199, E-CLASS(A124) E 320 (124.066) Convertible 06.93-03.98 162 220 3199, E-CLASS(A124) E 36 AMG(124.066) Convertible 05.94-03.98 200Q 272 3606, E-CLASS Coupe (C124) E 320(124.052) 06.93-06.97 162 220 3199, E-CLASS Coupe (C124) E36 amg(124.052) 05.94-06.97 200 272 3606, E-CLASS Estate (S124) E 280 T(124.088) 06.93-06.96 142 193 2799, E-CLASS Estate (S124) E 280 T(124.088) 06.93-06.96 145 197 2799, E-CLASS Estate (S124) E 320 T(124.092) 06.93-06.96 162 220 3199, E-CLASS Estate (S124) E 36 amg T(124.092) 05.94-06.96 200 272 3606, E-CLASS(W463) G 320(463.230,463.241) 09.94-12.97 155 211 3199, Closed off road Vehicle , E-CLASS Cabrio(W463) 320 GE (463.208) 09.94-11.97 155 211 3199, Open off road Vehicle , KOMBI Estate (S124) 280 TE (124.088) 10.92-06.93 145 197 2799, KOMBI Estate (S124) 320 TE (124.092) 10.92-06.93 162 220 3199, S-CLASS(140) 300 SE 2.8(140.028) Saloon 01.93-10.98 145 197 2799, S-CLASS(140) 300 SE/S320(140.032,140.039) 03.91-10.98 170 231 3199, ,033) Saloon , S-CLASS(W140) S 280 (140.028) Saloon 02.93-10.98 142 193 2799, SL(R129) 280 (129.058) Convertible 08.93-10.01 142 193 2799, SL(R129) 320 (129.063) Convertible 09.93-10.01 170 231 3199, Saloon (W124) 280 E(124.028) Saloon 10.92-06.93 145 197 2799, Saloon (W124) 320 E(124.028) Saloon 10.92-06.93 162 220 3199



GH5021

REPLACES / REEMPLAZA:

BOSCH: 0 280 217 529; **VW:** 071 906 461A

APPLICATION / APLICACIÓN:

AUDI: A3(8L1) 1.9 TDI Hatchback 08.00 96 130 1896, A3(8L1) 1.9 TDI quattro Hatchback 08.00 96 130 1896, A4(8E2.B6) 1.9 5DI Saloon 11.00 96 130 1896;

SEAT: LEON(1M1) 1.9 TDI Hatchback 02.01 110 150 1896, LEON(1M1) 1.9 TDI Hatchback 05.02 110 150 1896, TOLEDO II(1M2) 1.9 TDI 10.00 110 150 1896, TOLEDO II(1M2) 2.3 TDI 04.99-05.01 110 150 2324;

VW:BORA (1J2) 1.9 TDI Saloon 05.00 110 150 1896, BORA (1J2) 1.9 TDI Saloon 11.00 96 130 1896, BORA (1J2) 1.9 TDI 4motion Saloon 05.00 110 150 1896, BORA (1J2) 1.9 TDI 4motion Saloon 11.00 96 130 1896, BORA (1J2) 2.3 V5 10.98-10.00 110 150 2324, BORA (1J2) 2.3 V5 4motion 12.98-10.00 110 150 2324, BORA Estate(1J6) 1.9 TDI 11.00 96 130 1896, BORA Estate(1J6) 1.9 TDI 4motion 11.00 96 130 1896, BORA Estate(1J6) 2.3 V5 05.99-10.00 110 150 2324, BORA Estate(1J6) 2.3 V5 4motion 05.99-10.00 110 150 2324, GOLF IV (1J1) 1.9 TDI Hatchback 11.00 96 130 1896, GOLF IV (1J1) 1.9 TDI Hatchback 05.00 110 150 1896, GOLF IV (1J1) 1.9 TDI 4 Motion Hatchback 11.00 96 130 1896, GOLF IV (1J1) 1.9 TDI 4 Motion Hatchback 02.00 110 150 1896, GOLF IV (1J1) 2.3 V5 Hatchback 08.97-10.00 110 150 2324, GOLF IV (1J1) 2.3 V5 4 motion Hatchback 12.98-10.00 110 150 2324, GOLF IV Variant(1J5) 1.9 TDI Estate 11.00 96 130 1896, GOLF IV Variant(1J5) 1.9 TDI 4 motion Estate 11.00 96 130 1896, GOLF IV Variant(1J5) 2.3 V5 Estate 05.99 110 150 2324, GOLF IV Variant(1J5) 2.3 V5 4 motion Estate 05.99 110 150 2324, PASSAT(3B2) 2.3 VR 5 Saloon 10.96-11.00 110 150 2324, PASSAT(3B2) 2.3 VR 5 Syncro/4 motion Saloon 10.97-11.00 110 150 2324, PASSAT(3B3) 1.9 TDI Saloon 11.00 96 130 1896, PASSAT(3B3) 1.9 TDI 4motion Saloon 11.00 96 130 1896, PASSAT Variant(3B5) 2.3 VR5 Estate 06.97-11.00 110 150 2324, PASSAT Variant(3B5)2.3 VR5Syncro/4motionEstate 10.97-11.00 110 150 2324, PASSAT Variant(3B6) 1.9 TDI Estate 11.00 96 130 1896, PASSAT Variant(3B6) 1.9 TDI 4motion Estate 11.00 96 130 1896, TRANSPORTER IV bus(70xb,70xc,7db,7dw)2.5tdi 05.98 111 151 2461

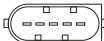

GH5022

REPLACES / REEMPLAZA:

BOSCH: 0 280 217 810; **MERCEDES:** 113 094 00 48

APPLICATION / APLICACIÓN:

MERCEDES: C-CLASS (W203) C 43 AMG(202.033) Saloon 08.97-05.00 225 306 4266, MERCE C-CLASS (W203) C 55 AMG(203.076) Saloon 02.04 270 367 5439, MERCE C-CLASS Estate (S202) C 43 AMG(202.093) 08.97-03.01 225 306 4266, MERCE C-CLASS T-model (S203) C 55 AMG(203.276) 02.04 270 367 5439, MERCE CLK(C208) 430 (208.370) Coupe 07.98-06.02 205 279 4266, MERCE CLK(C209) 500 (209.375) Coupe 06.02 225 306 4966, MERCE CLK(C209) 55 AMG(209.376) Coupe 09.02 270 367 5439



GH5023

REPLACES / REEMPLAZA:

BOSCH: 0 280 218 010; **ROVER:** MHK 100800

APPLICATION / APLICACIÓN:

LAND ROVER: LANDR RANGE ROVER II(LP) 3.9 07.94-03.02 140 190 3947, LANDR RANGE ROVER II(LP) 4.0 06.98-03.02 136 185 3950, LANDR RANGE ROVER II(LP) 4.6 07.94-03.02 165 224 4553, LANDR RANGE ROVER II(LP) 4.6 06.98-03.02 160 218 4554



GH5024

REPLACES / REEMPLAZA:

BOSCH: 0 281 218 002, 0 281 218 003; **VW:** 06A 906 461 A

APPLICATION / APLICACIÓN:

AUDI: A3(8L1) 1.8 Hatchback 09.96 92 125 1781, A3(8L1) 1.8 Quattro Hatchback 08.98 92 125 1781;

SEAT: LEON(1M1) 1.8 20V Hatchback 08.98 92 125 1781, TOLEDO II (1M2) 1.8 20 V Saloon 04.99 92 125 1781;

SKODA: OCTAVIA (1U2) 1.8 Hatchback 09.96 92 125 1781, OCTAVIA (1U2) 2.0 Hatchback 04.99 92 125 1781, OCTAVIA combi (1U5) 1.8 20v Estate 07.98 92 125 1781, OCTAVIA Combi (1U5) 2.0 Estate 04.99 85 116 1984, OCTAVIA Combi(1U5) 2.0 4X4 Estate 05.01 85 116 1984,

VW: BORA (1J2) 1.8 Saloon 10.98 92 125 1781, BORA (1J2) 1.8 4 motion 02.99 92 125 1781, BORA (1J2) 2.0 10.98 85 115 1984, BORA (1J2) 2.0 4 motion 04.00 85 115 1984, BORA Estate (1J6) 1.8 4 motion 05.99 92 125 1781, BORA Estate (1J6) 2.0 05.99 85 115 1984, BORA Estate (1J6) 2.0 4 motion 04.00 85 115 1984, GOLF IV (1J1) 1.8 Hatchback 08.97 92 125 1781, GOLF IV (1J1) 1.8 4 motion Hatchback 05.98 92 125 1781, GOLF IV (1J1) 2.0 Hatchback 07.98 85 115 1984, GOLF IV (1J1) 2.0 4 motion Hatchback 10.00 85 115 1984, GOLF IV Variant(1J5) 1.8 4 motion Estate 05.99 92 125 1781, GOLF IV Variant(1J5) 2.0 Estate 05.99 85 115 1984, GOLF IV Variant(1J5) 2.0 4 motion Estate 10.00 85 115 1984, LUPO (6X1,6E1) 1.2 TDI 3L Hatchback 07.99 45 61 1191, NEW BEETLE (9C1,1C1) 1.8 T Hatchback 10.99 110 150 1781, NEW BEETLE (9C1,1C1) 2.0 Hatchback 01.98 85 115 1984



GH5025

REPLACES / REEMPLAZA:

BOSCH: 0 280 218 017; **VW:** 071 906 461 B

APPLICATION / APLICACIÓN:

SEAT: ALHAMBRA(7V8,7V9) 2.8 V6 MPV 06.00 150 204 2792, ALHAMBRA(7V8,7V9) 2.8 V6 4motion MPV 02.01 150 204 2792, LEON (1M1) 2.8 Cupra 4 Hatchback 02.01 150 204 2792, TOLEDO II (1M2) 2.3 V5 20V 05.01 125 170 2324;

VW: BORA (1J2) 2.3 V5 10.00 125 170 2324, BORA (1J2) 2.3 V5 4 motion 10.00 125 170 2324, BORA (1J2) 2.8 V5 4 motion 03.99 150 204 2792, BORA Estate(1J6) 2.3 V5 10.00 125 170 2324, BORA Estate(1J6) 2.3 V5 4 motion 10.00 125 170 2324, BORA Estate(1J6) 2.8 V6 4 motion 05.99 150 204 2792, GOLF IV (1J1) 2.3 V5 Hatchback 10.00 125 170 2324, GOLF IV (1J1) 2.3 V5 4motion Hatchback 10.00 125 170 2324, GOLF IV (1J1) 2.8 V6 4motion Hatchback 03.99 150 204 2792, GOLF IV Variant(1J5) 2.3 V5 Estate 10.00 125 170 2324, GOLF IV Variant(1J5) 2.8 V6 Estate 05.99 150 204 2792, NEW BEETLE(9C1,1C1) 2.3 V5 Hatchback 10.00 125 170 2324, NEW BEETLE(9C1,1C1) RSI 3.2 Hatchback 04.00 165 224 3188, PASSAT (3B3) 2.3 V5 Saloon 11.00 125 170 2324, PASSAT (3B3) 2.3 V5 4 motion Saloon 11.00 125 170 2324, PASSAT Variant(3B6) 2.3 VR 5Estate 11.00 125 170 2324, PASSAT Variant(3B6) 2.3 VR 5 4motion Estate 11.00 125 170 170 2324, SHARAN (7M8,7M9,7M6) 2.8 V6 24V MPV 04.00 150 204 2792, SHARAN (7M8,7M9,7M6) 2.8 V6 24V 4motion MPV 04.00 150 204 2792, TRANSPORTER IV Bus(70xb,70xc,7db,7dw)2.8v6 04.00 150 204 2792



GH5026

REPLACES / REEMPLAZA:

BOSCH: 0 280 218 031; **OPEL:** 91 93 149, 92 27 760, 08 36 584

APPLICATION / APLICACIÓN:

OPEL: AGILA(H00) 1.0 12V Estate 09.00 43 58 973, AGILA(H00) 1.2 16V Esate 09.00 55 75 1199, ASTRA G Estate (F35_) 1.2 16V 09.00 55 75 1199, ASTRA G Hatchback(F48_,F08_) 1.2 16V 09.00 55 75 1199, ASTRA G Saloon(F69_) 1.2 16V 09.00 55 75 1199, CORSA C (F08,F68) 1.0 Hatchback 09.00 43 58 973, CORSA C (F08,F68) 1.2 Hatchback 09.00 55 75 1199, CORSA C Box (F08,W5L) 1.2 16V 09.00 55 75 1199;

VAUXH: AGILA 1.0 12 V Esate 09.00 43 58 973, VAUXH AGILA 1.2 12 V Esate 09.00 55 75 1199, VAUXH ASTRA Mk IV 1.2 16V Saloon 09.00 55 75 1199, VAUXH ASTRA Mk IV 1.2 16V Estate 09.00 55 75 1199, VAUXH ASTRA Mk IV 1.2 16V Hatchback 09.00 55 75 1199, VAUXH CORSA Mk IV II 1.0 12V Hatchback 09.00 43 58 973, VAUXH CORSA Mk IV II 1.2 16V Hatchback 09.00 55 75 1199, VAUXH CORSA Mk IV II 1.2 16V dualfuel Hatchback 08.01 55 75 1199, VAUXH CORSAVAN Mk IV II 1.2 16V Box 09.00 55 75 1199, VAUXH CORSAVAN Mk IV II 1.2 16V dualfuel Box 08.01 55 75 1199



GH5027

REPLACES / REEMPLAZA:

BOSCH: 0 280 217 117; **VW:** 037 906 461 C; **FORD:** 98VW 12B529 BA

APPLICATION / APLICACIÓN:

AUDI: A3(8L1) 1.8 T Hatchback 12.96 110 150 1781, A3(8L1) 1.8 T quattro Hatchback 12.96 110 150 1781, A4(8D2,B5) 1.8 T Saloon 12.97-11.00 132 180 1781, A4(8D2,B5) 1.8 T quattro Saloon 12.97-11.00 132 180 1781, A4 Avant (8D5,B5) 1.8 T quattro Estate 12.97-09.01 132 180 1781, A6(4B,C5) 1.8 T Saloon 01.97 110 150 1781, A6(4B,C5) 1.8 T Saloon 12.97 132 180 1781, A6(4B,C5) 1.8 T quattro Saloon 12.97 132 180 1781, A6(4B,C5) 1.8 T quattro Saloon 02.97 110 150 1781, A6 Avant (4B,C5) 1.8 T Estate 12.97 110 150 1781, A6 Avant (4B,C5) 1.8 T Estate 04.99 132 180 1781, A6 Avant (4B,C5) 1.8 T quattro Estate 12.97 110 150 1781, A6 Avant (4B,C5) 1.8 T quattro Estate 12.97 132 180 1781;

SEAT: ALHAMBRA(7V8,7V9) 1.8 T 20V MPV 10.97 110 150 1781;

SKODA: OCTAVIA(1U2) 1.8 T Hatchback 08.97 110 150 1781, OCTAVIA(1U2) 1.8 T 4x4 Hatchback 05.01 110 150 1781, OCTAVIA(1U2) combi (1U5) 1.8T Estate 07.98 110 150 1781, OCTAVIA(1U2) combi (1U5) 1.8T 4x4 Estate 05.01 110 150 1781;

VW: BORA (1J2) 1.8 T Saloon 05.00 110 150 1781, BORA Estate(1J6) 1.8 Estate 05.00 110 150 1781, GOLF IV (1J1) 1.8 T Hatchback 08.97 110 150 1781, GOLF IV Variant(1J5) 1.8 T 05.00 110 150 1781, PASSAT(3B2) 1.8 T 10.96-11.00 110 150 1781, PASSAT Variant (3B5) 1.8 T Estate 06.97-11.00 110 150 1781, SHARAN(7M8,7M9,7M6) 1.8 T 20 V 09.97 110 150 1781



GH5028

REPLACES / REEMPLAZA:

BOSCH : 0 280 217 106; **FIAT:** 60588419, 7763718; **HOLDEN:** 90 510 154; **OPEL:** 8 36 567, 90 448 964, 90 510 154

APPLICATION / APLICACIÓN:

OPEL: ASTRA F Estate(51_,51_) 2.0 I 16V 03.93-01.98 110 150 1998, ASTRA FHatchback(53_,54_,58_,59_)2.0 GSI16V 09.91-01.98 110 150 1998, CALIBRA A(85_) 2.0 I 16V Coupe 06.90-02.94 110 150 1998, CALIBRA A(85_) 2.0 I 16V 4X4 Coupe 06.90-02.94 110 150 1998, OMEGA B(25_,26_,27_) 2.0 Saloon 03.94-12.00 85 115 1998, OMEGA B(25_,26_,27_) 2.0 Saloon 03.94-09.99 85 115 1998, OMEGA B Estate(21_,22_,23_) 2.0 Estate 03.94-09.99 85 116 1998, VECTRA A(86_,87_) 2000/GT 16V 01.89-06.94 110 150 1998, VECTRA A(86_,87_) 2000/GT 16V CAT 02.90-11.95 110 150 1998, VECTRA A Hatchback(88_,89_) 2.0 I 16v CAT 02.90-11.95 110 150 1998, VECTRA B(36_) 2.0 I Saloon 10.95-04.02 82 112 1998, VECTRA B Estate (31_) 2.0 I 11.96-02.02 82 112 1998, VECTRA B Hatchback(38_) 2.0 I 10.95-02.02 82 112 1998;

VAUXH: ASTRA Mk III Hatchback 2.0 I 16V 09.91-02.98 110 150 1998, CALIBRA 2.0 I 16V Coupe 06.90-02.94 110 150 1998, CALIBRA 2.0 I 16V 4x4 Coupe 06.90-02.94 110 150 1998, OMEGA 2.0 Saloon 03.94-12.00 110 150 1998, OMEGA 2.0 Saloon 03.94-09.99 85 115 1998, OMEGA 2.0 Estate 03.94-09.99 85 116 1998



GH5029

REPLACES / REEMPLAZA:

BOSCH : 0 281 002 144; **FIAT:** 46411675; **OPEL:** 91 153 783, 93 171 356, 08 36 582

APPLICATION / APLICACIÓN:

FIAT: BRAVO(182) 1.9 TD 100 S(182.BF) 03.96-10.01 74 100 1910, FIAT BRAVO(182) 1.9 TD 100 S(182.AF) 03.96-10.01 74 100 1910, FIAT MAREA (185) 1.9 TD 100 09.96 74 100 1910, FIAT MAREA (185) 2.4 TD 125 09.96-04.99 91 125 2387, FIAT MAREA Weekend(185) 1.9 TD 100 Estate 09.96 74 100 1910, FIAT MAREA Weekend(185) 1.9 TD 125 Estate 09.96-04.99 91 125 2387;

OPEL: ASTRA G Box(F70) 1.7TD 01.99 50 68 1700, ASTRA G Estate (F35) 1.7 DTI 16V 02.00 55 75 1686, ASTRA G Estate (F35) 1.7 DTI 16V 02.98-08.00 50 68 1700, ASTRA G Hatchback(F48_,F08_) 1.7 DTI 16V 02.00 55 75 1686, ASTRA G Hatchback(F48_,F08_) 1.7 DTI 16V 02.98-08.00 50 68 1700, ASTRA G Saloon(F69_) 1.7 DTI 16V 02.00 55 75 1686, ASTRA G Saloon(F69_) 1.7 TD 09.98-08.00 50 68 1700, COMBO Box Body / Estate 1.7 Di 16V 10.01 48 65 1686, COMBO Box Body / Estate 1.7 Di 16V 10.01 55 75 1686, COMBO Tour 1.7 Di 16V MPV 10.01 48 65 1686, COMBO Tour 1.7 Di 16V MPV 10.01 55 75 1686, CORSA C(F08,F68) 1.7 Di Hatchback 09.00 48 65 1686, CORSA C(F08,F68) 1.7 TDI Hatchback 09.00 55 75 1686, CORSA C Box(F08,W5L) 1.7 Di 16V 09.00 48 65 1686, CORSA C Box(F08,W5L) 1.7 TDI 16V 09.00 55 75 1686, FRONTERA A (5_MWL4) 2.3 TD(5JMWL4) 03.92-10.98 74 100 2260, FRONTERA A (5_MWL4) 2.R TDS 09.96-10.98 85 115 2499, FRONTERA A sport(5_SUD2) 2.5 TDS 09.96-10.98 85 115 2499, OMEGA B(25_,26_,27_) 2.0 DTI 16V Saloon 09.97-09.00 74 101 1995, OMEGA B Estate(21_,22_,23_) 2.0 DTI 16V 09.97-09.00 74 101 1995, VECTRA B(36_) 2.0 Di 16V Saloon 11.96-04.02 60 82 1995, VECTRA B(36_) 2.0 DTI 16V Saloon 06.97-04.02 74 101 1995, VECTRA B Estate (31_) 2.0 Di 16V 11.96-06.00 60 82 1995, VECTRA B Estate (31_) 2.0 DTI 16V 06.97-07.03 74 101 1995, VECTRA B Hatchback(38_) 2.0 Di 16V 11.96-06.00 60 82 1995, VECTRA B Hatchback(38_) 2.0 DTI 16V 06.97-07.03 74 101 1995, ZAFIRA(F75_) 2.0 Di 16V MPV 10.99 60 82 1995, ZAFIRA(F75_) 2.0 DTI 16V MPV 09.00 74 101 1995;

VAUXH: FRONTERA 2.3 TD Closed offroad Vehcile 03.92-10.98 74 100 2260, VAUXH FRONTERA 2.5 TDS Closed offroad Vehcile 09.96-10.98 85 115 2499, VAUXH FRONTERA Sport 2.5 TDS Open offroad Vehicle 09.96-10.98 85 115 2499

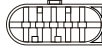

GH5030

REPLACES / REEMPLAZA:

BOSCH: 0 281 002 461; **VW:** 074 906 461 B; **FORD:** M211B529AA

APPLICATION / APLICACIÓN:

AUDI: A3(8L1) 1.9 TDI Hatchback 08.00 96 130 1896, A3(8L1) 1.9 TDI quattro Hatchback 08.00 96 130 1896, A3(8P1) 2.0 TDI Hatchback 05.03 103 140 1968, A3(8P1) 2.0 TDI Hatchback 05.03 100 136 1968, A3(8P1) 2.0 TDI quattro Hatchback 08.04 103 140 1968, A3 Sportback(8PA) 2.0 TDI Hatchback 09.04 103 140 1968, A3 Sportback(8PA) 2.0 TDI quattro Hatchback 11.05 103 140 1968, A4 (8E2,B6) 1.9 TDI Saloon 11.00 96 130 1896, A4 (8E2,B6) 1.9 TDI Saloon 06.04 85 116 1896, A4 (8E2,B6) 1.9 TDI quattro Saloon 11.01 96 130 1896, A4(8EC) 1.9 TDI Saloon 11.04 85 116 1896, A4(8EC) 2.0 TDI Saloon 11.04 100 136 1968, A4(8EC) 2.0 TDI Saloon 11.04 103 140 1968, A4 Avant(8E5,B6) 1.9 TDI Estate 06.04 85 116 1896, A4 Avant(8E5,B6) 1.9 TDI Estate 09.01 96 130 1896, A4 Avant(8E5,B6) 1.9 TDI quattro Estate 11.01 96 130 1896, A4 Avant(8ED) 1.9 TDI Estate 11.04 85 116 1896, A4 Avant(8ED) 2.0 TDI Estate 11.04 103 140 1968, A4 Convertible(8H) 2.0 TDI 10.05 103 140 1968, A6(4B,C5) 1.9 TDI Saloon 08.01 96 130 1896, A6(4F2) 2.0 TDI Saloon 06.05 100 136 1968, A6(4F2) 2.0 TDI Saloon 07.04 103 140 1968, A6 Avant(4B,C5) 1.9 TDI Estate 08.01 96 130 1896, A6 Avant(4F5) 2.0 TDI Estate 06.05 103 140 1968;

SEAT: ALTEA (5P1) 2.0 TDI MPV 03.04 100 136 1968, ALTEA (5P1) 2.0 TDI MPV 03.04 103 140 1968, LEON(1M1) 1.9 TDI Hatchback 05.03 96 130 1896, LEON(1M1) 1.9 TDI Hatchback 02.01 110 150 1896, LEON(1M1) 1.9 TDI Syncro Hatchback 05.02 110 150 1896, LEON(1P1) 2.0 TDI Hatchback 09.05 103 140 1968, TOLEDO II(1M2) 1.9 TDI Saloon 05.03 96 130 1896, TOLEDO II(5P2) 2.9 TDI MPV 10.04 103 140 1968;

SKODA: FABIA(6Y2) RS Hatchback 06.03 96 130 1896, OCTAVIA(1Z3) 2.0 TDI Hatchback 06.04 103 140 1968, OCTAVIA Combi (1Z5) 2.0 TDI Estate 06.04 103 140 1968;

VW: BORA (1J2) 1.9 TDI Saloon 05.00 110 150 1896, BORA (1J2) 1.9 TDI Saloon 11.00 96 130 1896, BORA (1J2) 1.9 TDI 4 motion 05.00 110 150 1896, BORA (1J2) 1.9 TDI 4 motion 11.00 96 130 1896, BORA Estate(1J6) 1.9 TDI 11.00 96 130 1896, BORA Estate(1J6) 1.9 TDI 05.01 110 150 1896, BORA Estate(1J6) 1.9 TDI 4 motion 05.01 110 150 1896, EOS 2.0 TDI Convertible 06.06 103 140 1968, GOLF IV (1J1) 1.9 TDI Hatchback 05.00 110 150 1896, GOLF IV (1J1) 1.9 TDI Hatchback 11.00 96 130 1896, GOLF IV (1J1) 1.9 TDI 4 motion Hatchback 11.00 96 130 1896, GOLF IV (1J1) 1.9 TDI 4 motion Hatchback 02.00 110 150 1896, GOLF IV Variant(1J5) 1.9 TDI Estate 11.00 96 130 1896, GOLF IV Variant(1J5) 1.9 TDI 4 motion 11.00 96 130 1896, GOLF V (1K1) 2.0 GTD Hatchback 11.05 125 170 1968, GOLF V (1K1) 2.0 TDI Hatchback 10.03 103 140 1968, GOLF V (1K1) 2.0 TDI Hatchback 10.03 100 136 1968, GOLF V PLUS(5M1) 2.0 TDI Hatchback 01.05 103 140 1968, GOLF V PLUS(5M1) 2.0 TDI Hatchback 05.05 100 136 1968, LT 28-46 II Box (2DX0AE) 2.8 TDI 01.99 96 130 2799, LT 28-46 II Box (2DX0AE) 2.8 TDI 06.97-12.98 92 125 2799, LT 28-46 II Box (2DX0AE) 2.8 TDI 04.02 116 158 2799, LT 28-46 II Flatbed / Chassis(2DX0FE) 2.8 TDI 06.97-12.98 92 125 2799, LT 28-46 II Flatbed / Chassis(2DX0DFE) 2.8 TDI 01.99 96 130 2799, LT 28-46 II Flatbed / Chassis(2DX0FE) 2.8 TDI 04.02 116 158 2799, MULTIVAN V (7HM) 2.5 TDI MPV 04.03 128 174 2461, MULTIVAN V (7HM) 2.5 TDI 4 motion MPV 07.04 128 174 2461, MULTIVAN V (7HM) 2.2 TDI 4 motion MPV 07.04 96 130 2461, PASSAT (3B3) 1.9 TDI Saloon 11.00 96 130 1896, PASSAT (3B3) 1.9 TDI 4motion Saloon 11.00 96 130 1896, PASSAT (3B3) 2.0 TDI Saloon 12.03 100 136 1968, PASSAT (3C2) 2.0 TDI Saloon 08.05 125 170 1968, PASSAT (3C2) 2.0 TDI Saloon 03.05 103 140 1968, PASSAT (3C2) 2.0 TDI 4 motion Saloon 03.05 103 140 1968, PASSAT Variant (3B6) 1.9 TDI Estate 11.00 96 130 1896, PASSAT Variant (3B6) 2.0 TDI Estate 12.03 100 136 1968, PASSAT Variant (3C5) 2.0 TDI Estate 08.05 125 170 1968, PASSAT Variant (3C5) 2.0 TDI Estate 08.05 100 136 1968, PASSAT Variant (3C5) 2.0 TDI Estate 08.05 90 122 1968, PASSAT Variant (3C5) 2.0 TDI 4 motion Estate 08.05 103 140 1968, PHAETON (3D2) 5.0 V10 TDI 4 motion Saloon 11.02 230 313 4921, POLO (9N_) 1.9 TDI Hatchback 11.03 96 130 1896, SHARAN (7M8,7M9,7M6) 1.9 TDI MPV 11.02 96 130 1896, SHARAN (7M8,7M9,7M6) 1.9 TDI MPV 06.05 110 150 1896, TOUAREG (7LA) 2.5 R5 TDI Close offroad Vehicle 01.03 128 174 2461, TOUAREG (7LA) 5.0 V10 TDI Close offroad Vehicle 10.02 230 313 4921, TOURAN 2.0 TDI MPV 08.03 103 140 1968, TOURAN 2.0 TDI MPV 12.05 125 170 1968, TOURAN 2.0 TDI MPV 02.03 100 136 1968, TRANSPORTER IV Box (70X,70XC,7DB,7DW) 05.98 111 151 2461, 2.5 TDI Bus, TRANSPORTER V Box(7HA,7HH) 2.5 TDI 04.03 128 174 2461, TRANSPORTER V Box(7HA,7HH) 2.5 TDI 04.03 96 130 2461, TRANSPORTER V Box(7HA,7HH) 2.5 TDI 4motion 07.04 128 174 2461, TRANSPORTER V Box(7HA,7HH) 2.5 TDI 4motion 07.04 96 130 2461, TRANSPORTER V Bus(7HB,7HJ) 2.5 TDI 04.03 96 130 2461, **VW TRANSPORTER V Bus(7HB,7HJ) 2.5 TDI 4motion 07.04 128 174 2461, VW TRANSPORTER V Bus(7HB,7HJ) 2.5 TDI 4motion 07.04 96 130 2461**

GH5031

REPLACES / REEMPLAZA:

SIEMENS: 5WK9623; **HELLA:** 8ET 009 142-141; **CITROËN:** 1920.8Q; **FIAT:** 9628336380; **PEUGEOT:** 1920.8Q

APPLICATION / APLICACIÓN:

CITROËN: BERLINGO(MF) 1.9 D(MFWJZ) MPV 07.98 51 70 1868, BERLINGO Box(M_) 1.9 D(MBWJZ,MCWJZ) 04.99 51 69 1868, JUMPER Box(230L) 2.0 HDI 11.01-04.02 62 84 1997, JUMPER Box(244L) 2.0 HDI 04.02 62 84 1997, JUMPER Box(244) 2.2 HDi 04.02 74 101 2179, JUMPER Bus(244_Z_) 2.0 HDi 04.02 62 84 1997, JUMPER Bus(244_Z_) 2.2 HDi 04.02 74 101 2179, JUMPER Flatbed/Chassis (244) 2.0 HDi 04.02 62 84 1997, JUMPER Flatbed/Chassis (244) 2.2 HDi 04.02 74 101 2179, XSARA (N1) 2.9 HDi 109 Hatchback 05.01 80 109 1997, XSARA (N1) 2.9 HDi 90 Hatchback 02.99 66 90 1997, XSARA Break (N2) 2.0 HDi 90 Estate 02.99 66 90 1997, XSARA Break (N2) 2.0 HDi 109 Estate 05.01 80 109 1997, XSARA Coupe (N0) 2.0 HDi 90 02.99 66 90 1997, XSARA Coupe (N0) 2.0 HDi 109 05.01 80 109 1997, XSARA PICASSO (N68) 2.0 HDi MPV 12.99 66 90 1997;

FIAT: DUCATO Box(230L) 2.0 JTD 10.01-04.02 62 84 1997, DUCATO Box(244) 2.0 JTD 04.02 62 84 1997, DUCATO Bus(230) 2.0 JTD 10.01-04.02 62 84 1997, DUCATO Bus(244_Z_) 2.0 JTD 04.02 62 84 1997, DUCATO Flatbed/Chassis (244) 2.0 JTD 04.02 62 84 1997;

PEUGEOT: 206(2A/C) 2.0 HDi 90 Hatchback 12.99 66 90 1997, 206 SW (2E/K) 2.0 HDi Estate 07.02 66 90 1997, 306(7B,N3,N5) 1.9 D Saloon 09.98 51 69 1868, 306 Break(7E,N3,N5) 1.9 D Estate 09.98 51 69 1868, 306 Hatchback(7A,7C,N3,N5) 1.9 D 09.98 51 69 1868, 307 (3A/C) 2.0 HDi 90 Hatchback 08.00 66 90 1997, 307 Break(3E) 2.0 HDi 90 03.02 66 90 1997, 307 SW (3H) 2.0 HDi 90 Estate 03.02 66 90 1997, BOXER Box (244) 2.0 HDi 04.02 62 84 1997, BOXER Box(244) 2.2 HDi 04.02 74 101 2179, BOXER Box(244_Z_) 2.0 HDi 04.02 62 84 1997, BOXER Box(244_Z_) 2.2 HDi 04.02 74 101 2179, BOXER Flatbed /Chassis (244) 2.0 HDi 04.02 62 84 1997, BOXER Flatbed /Chassis (244) 2.2 HDi 04.02 74 101 2179, EXPERT Flatbed/Chassis (223) 1.9D 02.96 51 70 1905, PARTNER Box(5) 1.9 D 06.96 51 69 1905, PARTNER CombiSpace(5F) 1.9 D MPV 12.98 51 69 1868

GH5032

REPLACES / REEMPLAZA:

BOSCH: 0 280 218 108; **VOLVO:** 8670112, 8670263

APPLICATION / APLICACIÓN:

VOLVO: C70 Convertible 2.0 T 03.98 166 226 1984, C70 Convertible 2.0 T 03.00 120 163 1984, C70 Convertible 2.3 T-5 03.98 176 239 2319, C70 Convertible 2.5 T 03.98 142 193 2435, C70 Coupe 2.0 T 03.00-09.02 120 163 1984, C70 Coupe 2.0 T 03.97-09.02 166 226 1984, C70 Coupe 2.3 T-5 03.97-09.02 176 240 2319, C70 Coupe 2.5 T 03.97-09.02 142 193 2435, S60 2.4 T Saloon 11.00 147 200 2435, S60 T 5 Saloon 11.00 184 250 2319, S70 2.0 Saloon 01.97-11.00 120 163 1984, S70 2.0 Turbo Saloon 01.97-11.00 166 226 1984, S70 2.3 T-5 Saloon 01.97-11.00 176 239 2319, S70 2.4 Turbo Saloon 01.97-11.00 142 193 2435, S70 2.5 TDI Saloon 01.97-11.00 103 140 2461, S80 2.0 Saloon 06.98 120 163 1984, S80 2.0 T Saloon 06.98 166 226 1984, S80 2.0 T Saloon 12.99 132 180 1984, S80 2.4 T Saloon 06.00 147 200 2435, S80 2.5 TDI Saloon 01.99 103 140 2461, S80 2.9 Saloon 05.98 150 204 2922, S80 2.9 Saloon 03.99 147 220 2922, V70 I Estate 2.0 01.97-03.00 120 163 1984, V70 I Estate 2.0 Turbo 01.97-03.00 166 226 1984, V70 I Estate 2.0 Turbo AWD 01.97-03.00 166 226 1984, V70 I Estate 2.3 T-5 01.97-03.00 176 239 2319, V70 I Estate 2.3 T-5 AWD 01.97-03.00 176 239 2319, V70 I Estate 2.4 Turbo 01.97-03.00 142 193 2435, V70 I Estate 2.5 AWD 03.99-03.00 195 265 2435, V70 I Estate 2.5 TDI 01.97-05.00 103 140 2461, V70 I Estate 2.5 Turbo AWD 01.97-05.00 142 193 2435, V70 II Estate 2.0 T 07.01 132 180 1984, V70 II Estate 2.3 T 5 03.00 184 250 2319, V70 II Estate 2.4 T 03.00 147 200 2435, V70 II Estate 2.5 TDI 03.00 103 140 2461, XC70 CROSS COUNTRY 2.4 T XC AWD 03.00-09.02 147 200 2435





GH5033

REPLACES / REEMPLAZA:

SIEMENS: 5WK9621; FIAT: 9629471080; LANCIA: 9629471080; PEUGEOT: 1920.7S

APPLICATION / APLICACIÓN:

CITROËN: BERLINGO(MF) 1.9 D(MFWJZ) MPV 07.98 51 70 1868, BERLINGO(MF) 2.0 HDI (MFRHY) MPV 12.99 66 90 1997, BERLINGO Box(m_) 1.9 D (MBWJZ,MCWJZ) 04.99 51 69 1868, BERLINGO Box(M_) 1.9 D 4WD 07.98 51 69 1868, BERLINGO Box(M_) 2.0 HDI 90 (MBRHY,MCRHY) 12.99 66 90 1997, EVASION (22.U6) 2.0 HDI MPV 08.99-07.02 80 109 1997, JUMPY(U6U) 1.9 D MPV 04.98 51 69 1868, JUMPY(U6U) 2.0 HDi MPV 03.00 80 109 1997, JUMPY(U6U) 2.0 HDi MPV 10.99 69 94 1997, JUMPY Box 1.9 D 04.98 51 69 1868, JUMPY Box 2.0 HDi 01.02 80 109 1997, JUMPY Box 2.0 HDi 10.99 69 94 1997, JUMPY Flatbed/Chassis 2.0 HDi 10.99 69 94 1997, JUMPY (X2) 2.0 HDi 109 Hatchback 02.99 80 109 1997, XANTIA (X2) 2.0 HDi 90 Hatchback 03.99 66 90 1997, XANTIA Break (X2) 2.0 HDi 109 Estate 02.99 80 109 1997, XANTIA Break (X2) 2.0 HDi 90 Estate 03.99 66 90 1997, XSARA(N1) 1.9 D Hatchback 07.98 51 70 1868, XSARA Break(N2) 1.9 D Estate 07.98 51 70 1868, XSARA Coupe (NO) 1.9 D Coupe 02.99 51 70 1868, XSARA PICASSO (N68) 2.0 HDi MPV 12.99 66 90 1997;

FIAT: SCUDO Box(220L) 2.0 JTD 12.02 80 109 1997, SCUDO Box(220L) 2.0 JTD 12.99 69 94 1997, SCUDO Combinato (220P) 1.9 D Estate 04.98 51 69 1868, SCUDO Combinato (220P) 2.0 JTD Estate 12.99 80 109 1997, ULYSSE(220L) 2.0 JTD MPV 10.99-08.02 80 109 1997;

LANCIA: ZETA (220) 2.0 JTD (220AN5) MPV 09.99-09.02 80 109 1997;

PEUGEOT: 306 (7B,N3,N5) 2.0 HDI 90 Saloon 06.99 66 90 1997, 306 Break(7E,N3,N5) 2.0 HDi 90 Estate 06.99 66 90 1997, 306 Hatchback(7A,7C,N3,N5) 2.0 HDI 90 06.99 66 90 1997, 307 (3A/C) 2.0 HDi 110 FAP Hatchback 08.00 79 107 1997, 307 (3A/C) 2.0 HDi 90 Hatchback 08.00 66 90 1997, 307 Break (3E) 2.0 HDI 90 Estate 03.02 66 90 1997, 307 SW(3H) 2.0 HDI 110 FAP Estate 03.02 79 107 1997, 307 SW(3H) 2.0 HDI 90 Estate 03.02 66 90 1997, 406(8B) 2.0 HDI 110 Saloon 06.98-08.01 80 109 1997, 406(8B) 2.0 HDI 90 Saloon 02.99-05.04 66 90 1997, 406(8B) 2.0 HDi 110 FAP Saloon 08.01-05.04 79 107 1997, 406 Break(8E/F) 2.0 HDi 110 Estate 02.99-04.04 80 109 1997, 406 Break(8E/F) 2.0 HDi 90 Estate 02.99 66 90 1997, 406 Break(8E/F) 2.0 HDi 110 FAP 08.01 79 107 1997, 806(221) 2.0 HDi MPV 08.99-08.02 80 109 1997, EXPERT (224) 2.0 HDi MPV 07.00 80 109 1997, EXPERT (224) 2.0 HDi MPV 07.00 80 109 1997, EXPERT Box(222) 1.9 D 70 12.98 51 69 1868, EXPERT Box(222) 2.0 HDi 07.00 80 109 1997, EXPERT Box(222) 2.0 HDi 07.00 69 94 1997, PARTNER Box(5) 2.0 HDi 04.00 66 90 1997, PARTNER Combispace (5F) 2.0 HDi MPV 02.00 66 90 1997



GH5034

REPLACES / REEMPLAZA:

BOSCH: 0 281 002 224; VW: 059 906 461A

APPLICATION / APLICACIÓN:

VW: PASSAT(3B2) 2.5 TDI Saloon 07.98-11.00 110 150 2496, PASSAT(3B2) 2.5 TDI Syncro/4motion Saloon 12.98-11.00 110 150 2496, PASSAT Variant(3B5) 2.5 TDI Estate 07.98-11.00 110 150 2496, PASSAT Variant(3B5) 2.5 TDI Syncro/4motion Estate 12.98-11.00 110 150 2496

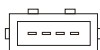

GH5035

REPLACES / REEMPLAZA:

BOSCH : 0 281 002 139; OPEL: 90 528 254, 08 36 626

APPLICATION / APLICACIÓN:

OPEL: VECTRA B(36_) 2.0 DI 16V Saloon 11.96-04.02 60 82 1995, VECTRA B(31_) 2.0 DI 16V Estate 11.96-06.00 60 82 1995, VECTRA B Hatchback(38_) 2.0 DI 16V 11.96-06.00 60 82 1995;

VAUXH: VECTRA 2.0 DI 16V Saloon 11.96 60 82 1995, VAUXH VECTRA Estate 2.0 DI 16V 11.96 60 82 1995, VAUXH VECTRA Hatchback 2.0 DI 16V 11.96 60 82 1995



GH5036

REPLACES / REEMPLAZA:

HELLA: 8ET 009 142-001; SIEMENS: 5WK9620; RENAULT: 7700104426, 7700109812; OPEL: 44 02 733, 9110733; NISSAN: 16580-00QAB

APPLICATION / APLICACIÓN:

OPEL: MOVANO Box(F9) 1.9 DTI 09.00-10.01 59 80 1870, MOVANO Combi(J9) 1.9 TDI Bus 09.00-10.01 59 80 1870, VIVARO Box 1.9 DI 08.01 60 80 1870, VIVARO Box 1.9 DTI 08.01 74 101 1870, VIVARO Box 2.5 DTI 05.03 99 135 2463, VIVARO Combi 1.9 DTI 08.01 74 101 1870, VIVARO Combi 2.5 DTI 05.03 99 135 2463;

RENAULT: CLIO II(BB0/1/2,CB0/1/2_) 1.9 DTI (B/CB0U)Hatch 02.00 59 80 1870, KANGOO(KC0/1_) 1.9 Dci 4x4 (KC0V) MPV 10.01 59 80 1870, KANGOO(KC0/1_) 1.9 DTI(KC0U) MPV 02.00 59 80 1870, KANGOO Express (FC0/1_) 1.9 dci 4x4(FC0V) 10.01 59 80 1870, KANGOO Express (FC0/1_) 1.9 DTI (FC0V) 02.00 59 80 1870, LAGUNA (B56_)556_)1.9 DCI (B56W) Hatchback 09.99-03.01 79 107 1870, LAGUNA (B56_)556_)1.9 DTI (B56J) Hatchback 10.97-03.01 72 98 1870, LAGUNA Grandtour (K56_) 1.9 dci(K56W) Estate 09.99-03.01 79 107 1870, LAGUNA Grandtour (K56_) 1.9 dTi(K56J) Estate 10.97-03.01 72 98 1870, MASTER II Box (FD) 1.9 Dti Box 09.00 59 80 1870, MASTER II Bus(JD/ND) 1.9 DCI 80 Bus 11.01 60 82 1870, MASTER II Bus(JD/ND) 1.9 Dti Bus 09.00 59 80 1870, MEGANE Classic(LA0/1) 1.9 DCI (LA05,LA1F) 02.01 75 102 1870, MEGANE Classic(LA0/1) 1.9 DTI (LA08,LA0N) 03.97-02.01 72 98 1870, MEGANE Coach (DA0/1) 1.9 Dci (DA05,DA1F) 02.01 75 102 1870, MEGANE Coach(DA0/1) 1.9 Dti(DA0N) 03.97-02.01 72 98 1870, MEGANE Grandtour(KA0/1_) 1.9 dCi (KA05,KA1F) 02.01 75 102 1870, MEGANE I (BA0/1_) 1.9 dCi (BA05,BA1F) 02.01 75 102 1870, MEGANE I (BA0/1_) 1.9 dTi (BA08,BA0N) 03.97-02.01 72 98 1870, SCIC (JA0/1_) 1.9 dCi (JA05,JA1F) 11.00 75 102 1870, SCIC (JA0/1_) 1.9 dCi RX4 MPV 11.00 75 102 1870, SCIS (JA0/1_) 1.9 dTi (JA0N) MPV 09.99 72 98 1870, TRAFIC II Box (FL) 1.9 dCi 100 03.01 74 101 1870, TRAFIC II Box(FL) 1.9 dCi 80 03.01 60 82 1870, TRAFIC II Bus (JL) dCi 100 03.01 74 101 1870, TRAFIC II Bus (JL) dCi 80 03.01 60 82 1870;

VAUXH: MOVANO Combi (JD) 1.9 DTI 09.00-10.01 59 80 1870, MOVANO Van (FD) 1.9 DTI 09.00-10.01 59 80 1870, VIVARO Box 1.9 DTI 08.01 74 101 1870, VIVARO Box 2.5 DTI 04.04 99 135 2463, VIVARO Combi 1.9DTI 08.01 74 101 1870, VIVARO Combi 2.5 DTI 04.04 99 135 2463



GH5037

REPLACES / REEMPLAZA:

BMW: 13 621 432 356; **HYUNDAI:** 28164-37100; **SIEMENS:** 5WK9605, 5WK9608, 5WK9626; **KIA:** OK5581321, OK55813210; **HELLA:** 8ET009142-021

APPLICATION / APLICACIÓN:

BMW: 3(E46) 320 I Saloon03.98-09.00 110 150 1991,3(E46) 320 I Saloon09.00-02.05 125 170 2171,3(E46) 323 I Saloon03.98-09.00 125 170 2494,3(E46) 325 I Saloon09.00-02.05 141 192 2494,3(E46) 325 xi Saloon09.00-02.05 141 192 2494,3(E46) 328 I Saloon02.98-06.00 142 193 2973,3 compact(E46)325 ti Hatchback06.01-02.05 141 192 2494,3 Convertible (E46) 320 Ci 09.00 125 170 2171,3 Convertible (E46) 323 Ci 04.00-09.00 125 170 2494,3 Convertible (E46) 325 Ci 09.00 141 192 2494,3 Coupe (E46) 320 Ci 09.00 125 170 2171,3 Coupe (E46) 320 Ci 08.99-09.00 110 150 1991,3 Coupe (E46) 323 Ci 04.99-09.00 125 170 2494,3 Coupe (E46) 325 Ci 09.00 141 192 2494,3 Coupe (E46) 328 Ci04.99-06.00 142 193 2793,3 Touring (E46) 320 I Estate10.99-09.00 110 150 1991,3 Touring (E46) 320 I Estate09.00 125 170 2171,3 Touring (E46) 325 I Estate09.00 141 192 2494,3 Touring (E46) 325 XI Estate09.00 141 192 2494,3 Touring (E46) 328 I Estate 10.99-06.00 142 193 2793,5 (E39) 520 ISaloon09.00-06.03 125 170 2171,5 (E39) 520 ISaloon01.96-09.00 110 150 1991,5 (E39) 523 ISaloon11.95-09.00 125 170 2494,5 (E39) 525 ISaloon09.00-06.03 141 192 2494,5 (E39) 528 ISaloon11.95-09.00 142 193 2793,5 Touring (E39) 520 IEstate09.00-05.04 125 170 2171,5 Touring (E39) 520 IEstate01.97-09.00 110 150 1991,5 Touring (E39) 523 IEstate01.97-09.00 125 170 2494,5 Touring (E39) 525 IEstate09.00-05.04 141 192 2494,5 Touring (E39) 528 IEstate01.97-09.00 142 193 2793,7(E38) 728 iL Saloon08.95-11.01 142 193 2793,Z3 2.0Convertible04.99 110 150 1991,Z3 2.2 Convertible08.00 125 170 2171,Z3 2.8Convertible04.97-06.00 141 192 2793,Z3Coupe 2.8 07.97-06.00 141 192 2793;

HYUNDAI : SONATA III(EF) 2.5 V6 24V Saloon06.98-10.01 118 160 2493,XG 25Saloon12.98 120 163 2493;

KIA: CARNIVAL (UP) 2.5 V6 MPV08.99-10.01 121 165 2497



GH5039

REPLACES / REEMPLAZA:

BOSCH: 0 928 400 527; **BMW:** 13 62 2 247 074, 13 62 7 787 076, 13 71 2 247 002

APPLICATION / APLICACIÓN:

BMW: 3(E46) 318 d Saloon 09.01-03.03 85 116 1951, 3(E46) 318 d Saloon 03.03-02.05 85 116 1995, 3(E46) 320 d Saloon 09.01-02.05 110 150 1995, 3(E46) 320 d Saloon 04.98-09.01 100 136 1951, 3(E46) 330 d Saloon 10.99-02.05 135 184 2926, 3(E46) 330 xd Saloon 06.00-02.05 135 184 2926, 3 Compact(E46) 318 td Hatchback 03.03-02.05 85 115 1995, 3 Compact(E46) 320 td Hatchback 09.01-02.05 110 150 1995, 3 Convertible(E46) 320 cd 02.05 110 150 1995, 3 Coupe(E46) 320 Cd 11.03 110 150 1995, 3 Touring(E46) 318 d Estate 03.02 85 115 1951, 3 Touring(E46) 318 d Estate 03.03 85 116 1995, 3 Touring(E46) 320 d Estate 09.01 110 150 1995, 3 Touring(E46) 320 d Estate 03.00-09.01 100 136 1951, 3 Touring(E46) 330 d Estate 10.99 135 184 2926, 3 Touring(E46) 330 Xd Estate 06.00 135 184 2926, 5 (E39) 520 d Saloon 02.00-06.03 100 136 1951, 5 (E39) 525 d Saloon 02.00-06.03 120 163 2497, 5 (E39) 520 d Saloon 09.00-06.03 142 193 2926, 5 Touring (E39) 520 d Estate 02.00-09.03 100 136 1951, 5 Touring (E39) 520 d Estate 02.00-05.04 120 163 2497, 5 Touring (E39) 530 d Estate 09.00-05.04 142 193 2926, 7 (E39) 730 d Saloon 04.00-11.01 142 193 2926, X5(E53) 3.0 d Closed off- Road Vehicile 05.01 135 184 2925

GH5040

REPLACES / REEMPLAZA:

BOSCH: 0 281 002 308; **FIAT:** 4655982, 6081644

APPLICATION / APLICACIÓN:

FIAT: MAREA (185) 1.9 JTD Saloon 01.01 81 110 1910, MAREA Weekend(185) 1.9 JTD 110 Estate 01.01 81 110 1910, MULTIPLA (186) 1.9 JTD 110 MPV 03.01-07.02 81 110 1910, MULTIPLA (186) 1.9 JTD 110 MPV 07.02 85 115 1910, STILO(192) 1.9 D Multijet Hatchback 09.05 74 100 1910, SITLO(192) 1.9 JTD (192_XE1A) Hatchback 10.01 85 115 1910, SITLO(192) 1.9 JTD (192_XF1A) Hatchback 02.02 59 80 1910, SITLO(192) 1.9 JTD (192_XD1A) Hatchback 10.01 125 170 2446, STILO Multi Wagon (192) 1.9 D Multijet Estate 09.05 74 100 1910, STILO Multi Wagon (192) 1.9 JTD Multijet Estate 01.03 85 115 1910, STILO Multi Wagon (192) 1.9 JTD Estate 01.03 59 80 1910, STRADA (178E) 1.9 JTD Pickup 04.03 59 80 1910



GH5041

REPLACES / REEMPLAZA:

BOSCH: 0 280 218 032; **VW:** 06A 906 461 D

APPLICATION / APLICACIÓN:

AUDI: A3(8L1) 1.8 T Hatchback 12.96 110 150 1781, A3(8L1) 1.8 T Hatchback 12.98 132 180 1781, A3(8L1) 1.8 T Quattro Hatchback 10.98 132 180 1781, A3(8L1) 1.8 T Quattro Hatchback 12.96 110 150 1781, A4(8D2,B5) 1.8 T Saloon 01.95-11.00 110 150 1781, A4(8D2,B5) 1.8 T Quattro Saloon 01.95-11.00 110 150 1781, A4 Avant(8D5,B5) 1.8 T Estate 03.96-09.01 110 150 1781, A4 Avant(8D5,B5)T Quattro Estate 01.96-09.01 110 150 1781, A6 (4B,C5) 1.8 T Saloon 01.97 110 150 1781, A6 (4B,C5) 1.8 T Quattro Saloon 02.97 110 150 1781, A6 Avant(4B,C5) 1.8 T Estate 12.97 110 150 1781, A6 Avant(4B,C5) 1.8 T quattr Estate 12.97 110 150 1781, TT(8N3) 1.8 T Coupe 10.98 110 150 1781, TT(8N3) 1.8 T quattr Coupe 10.98 110 150 1781, TT Roadster (8N9) 1.8 T Convertible 10.99 110 150 1781, TT Roadster(8N9) 1.8 T Quattro Convertible 02.00 132 180 1781;

SEAT: CORDORA (6K2) 1.8 T 20V Cupra Hatchback 07.00-10.02 115 156 1781, IBIZA III (6K1) 1.8 T 20V Cupra Hatchback 07.00-02.02 115 156 1781, LEON(1M1) 1.8 20 VT Hatchback 11.99 132 180 1781, LEON(1M1) 1.8 20 VT4 Hatchback 11.99 132 180 1781;

SKODA: OCTAVIA(1U2) 1.8 T Hatchback 08.97 110 150 1781, OCTAVIA(1U2) combi(1U5) 1.8 T 07.98 110 150 1781;

VW: GOLF IV (1J1) 1.8 T Hatchback 08.97 110 150 1781, PASSAT Variant(3B5) 1.8 T Estate 06.97-11.00 110 150 1781



GH5042

REPLACES / REEMPLAZA:

BOSCH: 0 281 002 528; **HYUNDAI:** 28164 27500

APPLICATION / APLICACIÓN:

HYUNDAI: ACCENT(LC) 1.5 CRDI Hatchback 04.02 60 82 1493, ACCENT(LC) 1.5 CRDI Hatchback 01.02 60 82 1493, GTEZ (TB) 1.5 CRDI 03.03 60 82 1496, MATRIX (FC) 1.5 CRDI 10.01 60 82 1496





GH5043

REPLACES / REEMPLAZA:

BOSCH: 0 281 002 554; **HYUNDAI:** 281644A000

APPLICATION / APLICACIÓN:

HYUNDAI: H-1 Box 2.5 CRDi 08.03 103 140 2497, TERRACAN(HP) 2.9 CRDi Closed offroad Vehicle 12.01 110 150 2902, TERRACAN(HP) 2.9 CRDi Closed offroad Vehicle 11.03 120 163 2902;

KIA: SCORENTO (JC) 2.5 CRDi Closed offroad Vehicle 08.02 103 140 2497



GH5044

REPLACES / REEMPLAZA:

BOSCH: 0 280 218 111; **HYUNDAI:** 28164 38200, 28164 38210

APPLICATION / APLICACIÓN:

HYUNDAI: SANTA Fé(SM) 2.4 16V Closed offroad vehicle 02.01 107 146 2351, SANTA Fé(SM) 2.4 16V 4X4 Closed offroad vehicle 02.01 107 146 2351, SANTA Fé(SM) 2.7 16V 4X4 Closed offroad vehicle 02.01 127 173 2656;

KIA: SORENTO(JC) 2.4 Closed off road vehicle 08.02 102 139 2351



GH5045

REPLACES / REEMPLAZA:

BOSCH: 0 280 218 027; **HYUNDAI:** 28164 22610

APPLICATION / APLICACIÓN:

HYUNDAI: ACCENT(LC) 1.3 Hatchback 01.00 55 75 1341, ACCENT(LC) 1.3 Hatchback 08.02 62 84 1341, ACCENT(LC) 1.3 Hatchback 01.00 63 86 1341, ACCENT Saloon(LC) 1.3 01.00 63 86 1341, ACCENT Saloon(LC) 1.3 01.00 55 75 1341



GH5046

REPLACES / REEMPLAZA:

BOSCH: 0 280 218 037; **UAZ:** 20 385/293 376000-04/31602 3877012, 31602 3877014

APPLICATION / APLICACIÓN:

LADA: 112 1.5 Hatchback 01.95 54 73 1500

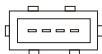

GH5047

REPLACES / REEMPLAZA:

KIA: 0K08013210

APPLICATION / APLICACIÓN:

KIA: SPORTAGE 2000 cc MOT.2.0 i.e 03.99 2000

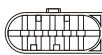

GH5048

REPLACES / REEMPLAZA:

BOSCH: 0 280 218 034; **VW:** 06A 906 461 E

APPLICATION / APLICACIÓN:

AUDI : A3 (8L1) S3 quattro Hatchback 03.99 154 210 1781, A3 (8N3) 1.8 T quattro Coupe 10.98 165 224 1781, AUDI TT Roadster (8N9) 1.8 T quattro 10.98 165 224 1781



GH5049

REPLACES / REEMPLAZA:

BOSCH: 0 280 218 152; **NISSAN:** 22680 5M000

APPLICATION / APLICACIÓN:

NISSAN: MAXIMA QX(A33) 2.0 V6 24V 03.00 103 140 1995, MAXIMA QX(A33) 3.0 V6 24V 03.00 147 200 2998, PATROL GR II (Y61) 3.0 DTI 05.00 116 158 2953, X-TRAIL (T30) 2.0 4X4 07.01 103 140 1998, X-TRAIL (T30) 2.0 4X4 01.03 121 165 2498;

SUBARU : FORESTER (SF) 2.0 S Turbo 06.98-04.01 125 170 1994, IMPREZA (GC) 2.0 I 4WD 06.98-12.00 92 125 1994



GH5050

REPLACES / REEMPLAZA:

BOSCH: 0 280 217 800; **BMW:** 13 62 1 702 078, 13 62 1 733 262, 13 62 1 747 156; **FERRARI:** 162397

APPLICATION / APLICACIÓN:

BMW: 5 (E34) 540 I V8 Saloon 09.92-09.95 210 286 3982, 5 (E39) 540 I Saloon 04.96-06.03 210 286 4398, 5 Touring (E34) 540 I Estate 09.93-01.97 210 286 3982, 5 Touring (E34) 540 I Estate 01.97-05.04 210 286 4398, 7 (E32) 740 I, LV8 Saloon 04.92-09.94 210 286 3982, 7 (E38) 740 I, iL Saloon 01.96-11.01 210 286 4398, 7 (E38) 740 I, iL Saloon 10.94-11.01 210 286 3982, 8 (E31) 840 Ci Coupe 01.96-12.99 210 286 4398, 8 (E31) 840 I Coupe 02.93-02.96 210 286 3982

GH5051

REPLACES / REEMPLAZA:

PIERBURG: 7.22684.07.0; **MERCEDES:** A 611 094 00 48, 611 094 00 48

APPLICATION / APLICACIÓN:

MERCEDES: A-CALSS(W168) A 170 CDI(168.008) Hatchback 07.98-02.01 66 90 1689, A-CALSS(W168) A 170 CDI(168.009 02.01-08.04 70 95 1689, 168.109) Hatchback, C-CALSS(W202) A 200 CDI(202.134) Saloon 03.98-05.00 75 102 2151, C-CALSS(W202) A 220 CDI(202.133) Saloon 09.97-05.00 92 125 2151, C-CALSS(W203) A 200 CDI(203.004) Saloon 09.00 85 116 2148, C-CALSS(W203) A 220 CDI(203.006) Saloon 05.00 105 143 2148, C-CALSS(W203) A 270 CDI(203.016) Saloon 12.00 125 170 2685, C-CALSS(W203) Coupe (CL203) C 220 CDI (203.03.01 75 102 2151, 706), C-CALSS(W203) Estate (S202) C 200 T CDI (202.03.98-03.01 75 102 2151, 194), C-CALSS(W203) Estate (S202) C 220 T CDI (202.09.97-03.01 92 125 2151, 193), C-CLASS T-model(S203) C 220 CDI (203.206) Estate 03.01 105 143 2148, C-CLASS T-model(S203) C 270 CDI (203.216) Estate 03.01 125 170 2685, E-CLASS (W210) E 200 CDI (210.007) Saloon 07.99-03.02 85 116 2148, E-CLASS (W210) E 200 CDI (210.007) Saloon 06.98-03.02 75 102 2151, E-CLASS (W210) E 220 CDI (210.006) Saloon 07.99-03.02 105 143 2148, E-CLASS (W210) E 220 CDI (210.006) Saloon 06.98-07.99 92 125 2151, E-CLASS (W210) E 270 CDI (210.006) Saloon 07.99-03.02 125 170 2688, E-CLASS(W210) E 320 CDI(210.026) Saloon 07.99-03.02 145 197 3226, E-CLASS Estate(S210) E 220 T CDI (210.206) 06.98-07.99 92 125 2151, E-CLASS Estate(S210) E 220 T CDI (210.206) 07.99-03.03 105 143 2148, E-CLASS Estate(S210) E 270 T CDI (210.216) 07.99-03.03 125 170 2668, E-CLASS Estate(S210) E 320 T CDI (210.226) 07.99-03.03 145 197 3226, G-CLASS (W463) G 270 CDI(463.322,463.323) 10.01 115 156 2685, M-CLASS (W163) ML 270 CDI(163.113) 12.99-06.05 120 163 2685, S-CLASS (W220) S 320 CDI (220.026,220.126)Saloon 08.99-09.02 145 197 3222, S-CLASS (W220) S 400 CDI (220.028,220.128)Saloon 06.03-08.05 191 260 3996, S-CLASS (W220) S 400 CDI (220.028,220.128)Saloon 06.00-08.05 184 250 3996, V-CLASS(638/2) V 200 CDI(638.294) MPV 03.99 75 102 2148, V-CLASS(638/2) V 220 CDI(638.294) MPV 03.99 90 122 2148, V-CLASS(638/2) V 220 CDI(638.294) MPV 02.02 67 91 1689, V-CLASS(638/2) V 220 CDI(638.294) MPV 02.02 55 75 1689, VITO Box(638) 108 CDI 2.2 03.99 60 82 2151, VITO Box(638) 110 CDI 2.2 03.99 75 102 2151, VITO Box(638) 112 CDI 2.2 03.99 90 122 2148, VITO Bus(638) 108 CDI 2.2 03.99 60 82 2148, VITO Bus(638) 110 CDI 2.2 03.99 75 102 2148, VITO Bus(638) 112 CDI 2.2 03.99 90 122 2148



GH5052

REPLACES / REEMPLAZA:

BOSCH: 0 280 217 111; **FIAT:** 60810813; **ALFA ROMEO:** 46407008

APPLICATION / APLICACIÓN:

ALFA: 145(930) 1.6 i.e 16V T.S. Hatchback 12.96-01.01 88 120 1598, 145(930) 1.7 i.e 16V Hatchback 10.94-12.96 95 129 1712, 145(930) 1.8 i.e 16V Hatchback 03.98-01.01 106 144 1747, 145(930) 1.8 i.e 16V T.S. Hatchback 12.96-12.98 103 140 1747, 145(930) 2.0 16V Quadrifoglio Hatchback 03.98-01.01 114 155 1970, 145(930) 2.0 16V T.S. Hatchback 10.95-01.01 110 150 1970, 146(930) 1.6 16V T.S. Hatchback 11.96-01.01 88 120 1598, 146(930) 1.7 16V Hatchback 12.94-12.96 95 129 1712, 146(930) 1.8 i.e 16V T.S. Hatchback 11.96-01.01 103 140 1747, 146(930) 1.8 i.e 16V T.S. Hatchback 03.98-01.01 106 144 1747, 146(930) 2.0 i.e 16V Quadrifoglio Hatchback 03.98-01.01 114 155 1970, 146(930) 2.0 16V T.S. Hatchback 10.95-01.01 110 150 1970, 155(167) 1.6 16V T.S. Saloon 05.96-01.98 88 120 1598, 155(167) 1.7 16V T.S. Saloon 05.96-12.97 103 140 1747, 155(167) 2.0 T.S. 16V(167.A2G) Saloon 03.95-12.97 110 150 1970, 156(932) 1.6 16V T.SPARK(932A4) Saloon 09.97 88 120 1598, GTV(916C_) 2.0 T.SPARK 16V(916.C2_916C2C00) 06.95 110 150 1970, SPIDER(916S_) 2.0 T.SPARK 16V(916S2C00) 06.95 110 150 1970;

FIAT: BRAVO (182) 2.0 HGT 20V (182.AD) Hatchback 10.95-07.98 108 147 1998, Coupe(FA/175) 2.0 20V 08.96-04.98 108 147 1998, MAREA (185) 2.0 150 20V Saloon 09.96-04.99 108 147 1998, MAREA Weekend (185) 2.0 150 20V Estate 09.96-04.99 108 147 1998;

LANCIA: KAPPA(838A) 2.0 20V(838AA1AA) Saloon 10.94-10.01 107 146 1998, KAPPA(838A) 2.0 20V(838AG1AA,838AG11A) Saloon 07.96-10.01 114 155 1998, KAPPA(838A) 2.4 20V(838AC1AA,838AC11A)Saloon 08.94-10.01 129 175 2446, KAPPA Coupe (838) 2.0 20 V 07.96-03.01 114 155 1998, KAPPA Coupe (838) 2.4 20 V(838CC) 11.96-03.01 129 175 2446, KAPPA SW(838B) 2.0 20V(838BG1AA) Estate 07.96-10.01 114 155 1998, KAPPA SW(838B) 2.4 20V(838BC1AA,838BC11A) 07.96-10.01 129 175 2446

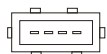

GH5053

REPLACES / REEMPLAZA:

BOSCH: 0 280 218 132; **VW:** 06B 906 461

APPLICATION / APLICACIÓN:

VW: PASSAT (3B3) 2.0 11.00 85 115 1984



GH5054

REPLACES / REEMPLAZA:

PIERBURG: 7.22684.08.0; **VW:** 028 906 461, 06A 906 461; **FORD:** 95 VW12B529 BB

APPLICATION / APLICACIÓN:

AUDI: A3(8L1) 1.9 TDI Hatchback 08.97-07.01 81 110 1896, A3(8L1) 1.9 TDI Hatchback 09.96-07.01 66 90 1896, A3(8L1) 1.9 TDI Hatchback 08.00 96 130 1896, A3(8L1) 1.9 TDI Hatchback 10.00 74 100 1896, A3(8L1) 1.9 TDI Hatchback 08.97-07.01 96 130 1896, A3(8L1) 1.9 TDI quattro Hatchback 08.00 96 130 1896, A3(8P1) 1.9 TDI Hatchback 05.03 77 105 1896, A4(8D2,B5) 1.9 TDI Saloon 12.95-11.00 55 75 1896, A4(8D2,B5) 1.9 TDI Saloon 01.95-11.00 66 90 1896, A4(8D2,B5) 1.9 TDI Saloon 03.00-11.00 85 116 1896, A4(8D2,B5) 1.9 TDI Saloon 10.95-11.00 81 110 1896, A4(8D2,B5) 1.9 TDI Saloon 01.95-11.00 66 90 1896, A4(8E2,B6) 1.9 TDI Saloon 11.00 96 130 1896, A4(8E2,B6) 1.9 TDI Saloon 05.01 74 101 1896, A4(8E2,B6) 1.9 TDI Saloon 11.00 96 130Q 1896, A4(8E2,B6) 1.9 TDI Saloon 06.04 85 116 1896, A4(8EC) 1.9 TDI 11.04 85 116 1896, A4 Avant(8D5,B5) 1.9 TDI Estate 02.96-09.01 66 90 1896, A4 Avant(8D5,B5) 1.9 TDI Estate 03.96-09.01 55 75 1896, A4 Avant(8D5,B5) 1.9 TDI Estate 02.96-09.01 81 110 1896, A4 Avant(8D5,B5) 1.9 TDI Estate 03.00-09.01 85 115 1896, A6(4A,C4) 1.9 TDI Saloon 06.94-02.97 66 90 1896, A6(4B,C5) 1.9 TDI Saloon 08.01 96 130 1896, A6(4B,C5) 1.9 TDI Saloon 07.00 85 115 1896, A6(4B,C5) 1.9 TDI Saloon 02.97 81 110 1896, A6 Avant(4A,C4) 1.9 TDI Estate 06.94-12.97 66 90 1896, A6 Avant(4B,C5) 1.9 TDI Estate 12.97 81 110 1896, A6 Avant(4B,C5) 1.9 TDI Estate 07.00 85 115 1896;

FORD: GALAXY (WGR) 1.9 TDI MPV 03.95 66 90 1896, GALAXY (WGR) 1.9 TDI MPV 08.97-04.00 81 110 1896, GALAXY (WGR) 1.9 TDI MPV 04.00 85 115 1896;

SEAT: ALHAMBRA(7V8,7V9) 1.9 TDI MPV 06.00 85 115 1896, ALHAMBRA(7V8,7V9) 1.9 TDI MPV 04.96 66 90 1896, ALHAMBRA(7V8,7V9) 1.9 TDI MPV 08.96-06.00 81 110 1896, ALHAMBRA(7V8,7V9) 1.9 TDI 4motion MPV 02.01 85 115 1896, CORDOBA(6K2) 1.9 TDI Hatchback 06.99-10.02 81 110 1896, CORDOBA Vario(6K5) 1.9 TDI Estate 06.99 81 110 1896, CORDOBA Vario(6K5) 1.9 TDI Estate 06.99 66 90 1896, IBIZA III(6K1) 1.9 TDI Hatchback 08.99-02.02 81 110 1896, LEON(1M1) 1.9 TDI Hatchback 11.99 81 110 1896, LEON(1M1) 1.9 TDI Hatchback 11.99 66 90 1896, TOLEDO I(1L) 1.9 TDI Hatchback 08.95-03.99 66 90 1896, TOLEDO I(1L) 1.9 TDI Hatchback 11.96-03.99 81 110 1896, TOLEDO II(1M2) 1.9 TDI Saloon 04.99 66 90 1896;

SKODA: FABIA(6Y2) 1.9 TDI Hatchback 01.00 74 100 1896, FABIA combi(6Y5) 1.9 TDI Estate 04.00 74 100 1896, FABIA Saloon(6Y3) 1.9 TDI Saloon 01.00 74 100 1896, OCTAVIA(1U2) 1.9 TDI Hatchback 09.96 66 90 1896, OCTAVIA(1U2) 1.9 TDI Hatchback 08.97 81 110 1896, OCTAVIA(1U2) 1.9 TDI Hatchback 01.03 96 130 1896, OCTAVIA(1Z3) 1.9 TDI Hatchback 06.04 77 105 1896, OCTAVIA Combi(1U5) 1.9 TDI Estate 07.98 66 90 1896, OCTAVIA Combi(1U5) 1.9 TDI Estate 07.98 81 110 1896, OCTAVIA Combi(1U5) 1.9 TDI Estate 07.98 66 90 1896, OCTAVIA Combi(1U5) 1.9 TDI Estate 01.03 96 130 1896, OCTAVIA Combi(1U5) 1.9 TDI 4X4 Estate 09.00 74 100 1896, OCTAVIA Combi(1U5) 1.9 TDI 4X4 Estate 09.00 74 100 1896, OCTAVIA Combi(1Z5) 1.9 TDI Estate 06.04 77 105 1896;

VW: BORA (1J2) 1.9 TDI Saloon 10.98-06.01 81 110 1896, BORA (1J2) 1.9 TDI Saloon 09.00 74 101 1896, BORA (1J2) 1.9 TDI Saloon 09.00 74 101 1896, BORA (1J2) 1.9 TDI Saloon 05.00 110 150 1896, BORA (1J2) 1.9 TDI Saloon 12.98-06.01 85 115 1896, BORA (1J2) 1.9 TDI Saloon 10.98-06.01 66 90 1896, BORA Estate(1J6) 1.9 TDI Estate 09.00 74 101 1896, BORA Estate(1J6) 1.9 TDI Estate 05.99-06.01 85 115 1896, BORA Estate(1J6) 1.9 TDI Estate 05.99-06.01 81 110 1896, BORA Estate(1J6) 1.9 TDI 4motion Estate 09.00 74 101 1896, BORA Estate(1J6) 1.9 TDI 4motion Estate 05.99-06.01 85 115 1896, CADDY II box(9K9A) 1.9 TDI 09.96-01.04 66 90 1896, CADDY II Estate(9K9B) 1.9 TDI 10.96-01.04 66 90 1896, COLF IV (1J1) 1.9 TDI Hatchback 09.00 74 101 1896, COLF IV (1J1) 1.9 TDI Hatchback 05.00 110 150 1896, COLF IV (1J1) 1.9 TDI Hatchback 08.97-05.04 81 110 1896, COLF IV (1J1) 1.9 TDI Hatchback 08.97-06.01 66 90 1896, COLF IV (1J1) 1.9 TDI Hatchback 12.98-06.01 85 115 1896, COLF IV (1J1) 1.9 TDI 4motion Hatchback 09.00 74 101 1896, COLF IV (1J1) 1.9 TDI 4motion Hatchback 04.98-06.01 66 90 1896, COLF IV (1J1) 1.9 TDI 4motion Hatchback 09.99-06.01 85 115 1896, GOLF IV Variant(1J5) 1.9 TDI Estate 09.00 74 101 1896, GOLF IV Variant(1J5) 1.9 TDI Estate 08.99-06.01 85 115 1896, GOLF IV Variant(1J5) 1.9 TDI Estate 05.99-06.01 81 110 1896, GOLF IV Variant(1J5) 1.9 TDI Estate 11.00 96 130 1896, GOLF IV Variant(1J5) 1.9 TDI 4 motion Estate 09.00 74 101 1896, GOLF IV Variant(1J5) 1.9 TDI 4 motion Estate 05.99-06.01 66 90 1896, GOLF IV Variant(1J5) 1.9 TDI 4 motion Estate 11.00 96 130 1896, NEW BEETLE(9C1,1C1) 1.9 TDI Hatchback 02.01 74 101 1896, NEW BEETLE(9C1,1C1) 1.9 TDI Hatchback 01.98-02.01 66 90 1896, PASSAT (3A2,351) 1.9 TDI Saloon 03.96-08.96 81 110 1896, PASSAT (3B2) 1.9 TDI Saloon 08.98-11.00 85 115 1896, PASSAT (3B2) 1.9 TDI Saloon 10.96-11.00 66 90 1896, PASSAT (3B2) 1.9 TDI Saloon 10.96-11.00 81 110 1896, PASSAT (3B2) 1.9 TDI Saloon 02.00-11.00 74 101 1896, PASSAT (3B2) 1.9 TDI 4 motion Saloon 08.99-11.00 85 115 1896, PASSAT (3B2) 1.9 TDI Syncro/4 motion Saloon 10.96-11.00 81 110 1896, PASSAT (3B3) 1.9 TDI Saloon 11.00 74 101 1896, PASSAT (3B3) 1.9 TDI Saloon 11.00 96 130 1896, PASSAT (3B3) 1.9 TDI 4 motion Saloon 11.00 96 130 1896, PASSAT Variant(3A5,351) 1.9 TDI Estate 10.93-05.97 66 90 1896, PASSAT Variant(3A5,351) 1.9 TDI Estate 03.96-05.97 81 110 1896, PASSAT Variant(3B5) 1.9 TDI Estate 06.97-11.00 66 90 1896, PASSAT Variant(3B5) 1.9 TDI Estate 02.00-11.00 74 101 1896, PASSAT Variant(3B5) 1.9 TDI Estate 08.98-11.00 85 115 1896, PASSAT Variant(3B5) 1.9 TDI 4 motion Estate 08.99-11.00 85 115 1896, PASSAT Variant(3B5) 1.9 TDI Syncro /4 motion Estate 06.97-11.00 81 110 1896, PASSAT Variant(3B6) 1.9 TDI Estate 11.00 74 101 1896, PASSAT Variant(3B6) 1.9 TDI Estate 11.00 96 130 1896, PASSAT Variant(3B6) 1.9 TDI 4motion Estate 11.00 96 130 1896, POLO (9N_) 1.9 TDI Hatchback 10.01 74 101 1896, POLO CLASSIC (6KV2) 110 1.9 TDI Saloon 06.98-09.01 81 110 1896, POLO CLASSIC (6KV2) 90 1.9 TDI Saloon 09.96-09.01 66 90 1896, POLO Variant(6KV5) 1.9 TDI Estate 05.97-09.01 66 90 1896, POLO Variant(6KV5) 1.9 TDI Estate 06.98-09.01 81 110 1896, SHARAN (7M8,7M9,7M6) 1.9 TDI MPV 11.02 96 130 1896, SHARAN (7M8,7M9,7M6) 1.9 TDI MPV 04.00 85 115 1896, SHARAN (7M8,7M9,7M6) 1.9 TDI MPV 09.95 66 90 1896, SHARAN (7M8,7M9,7M6) 1.9 TDI MPV 09.96-04.00 81 110 1896, SHARAN (7M8,7M9,7M6) 1.9 TDI 4 motion MPV 04.00 85 115 1896, TRANSPORTER IV Box (70XA) 2.5 TDI 09.95 75 102 2461, TRANSPORTER IV Box (70XA) 2.5 TDI 12.98 65 88 2461, TRANSPORTER IV Box (70XA) 2.5 TDI Syncro 09.95 75 102 2461, TRANSPORTER IV Bus(70XB,70XC,7DB,7DW) 2.5 TDI 05.98 65 88 2461, TRANSPORTER IV Bus(70XB,70XC,7DB,7DW) 2.5 TDI 09.95 75 102 2461, TRANSPORTER IV Bus(70XB,70XC,7DB,7DW) 2.5 TDI 01.96 75 102 2461, TRANSPORTER IV Flatbed /chassis (70XD) 2.5 TDI 09.95 75 102 2461, TRANSPORTER IV Flatbed /chassis (70XD) 2.5 TDI 05.98 65 88 2461, TRANSPORTER IV Flatbed /chassis (70XD) 2.5 TDI 05.98 75 102 2461

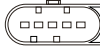

GH5055

REPLACES / REEMPLAZA:

BOSCH: 0 280 218 012; **FERRARI:** 171707; **HONDA :** 16400 PDD X00; **ROVER:** MHK 101070

APPLICATION / APLICACIÓN:

FERRARI: 360 MODENA (F131) 360 F1 Coupe 03.99 294 400 3586, 360 MODENA Spider (F131) 3.6 Convertible 02.00 294 400 3586;

HONDA: ACCORD VII (CG) 2.0 Turbo Di Saloon 02.99 77 105 1994, ACCORD VII Hatchback(CH) 2.0 Tdi 12.99-10.00 77 105 1994;

MG: MG ZR Turbo diesel Hatchback 06.01 74 100 1994, MG ZS 2.0 TD Saloon 01.04 74 101 1994, MG ZS Hatchback 2.0 TD 01.04 74 101 1994;

ROVER: 200(RF) 220 D/SD Hatchback 11.95-03.00 63 86 1994, 200(RF) 220 Sdi Hatchback 11.95-03.00 77 105 1994, 25 (RF) 2.0 Idt Hatchback 10.99 74 101 1994, 400 (RT) 420 D Saloon 11.95-03.00 63 86 1994, 400 (RT) 420 Di Saloon 05.95-03.00 77 105 1994, 400 (RT) 420 D Hatchback 11.95-03.00 63 86 1994, 400 (RT) 420 Di Hatchback 05.95-03.00 77 105 1994, 45(RT) 2.0 Idt Hatchback 02.00 74 101 1994, 45 Saloon (RT) 2.0 Idt 02.00 74 101 1994



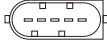

GH5058

REPLACES / REEMPLAZA:

BOSCH: 0 280 217 532; **ROVER:** ERR7171

APPLICATION / APLICACIÓN:

LAND ROVER: DISCOVERY II(LJ,LT) 4.0 V8 Closed off road 11,98 136 185 3950

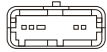

GH5060

REPLACES / REEMPLAZA:

SIEMENS: 5WK9628; **HELLA:** 8ET 009 142-321; **CITROËN:** 1920.AG; **FIAT:** 9632215820; **LANCIA:** 9632215820; **PEUGEOT:** 1920.AG

APPLICATION / APLICACIÓN:

CITROËN: C5 2.0 Hdi (DCRHZB,DCRHZE) Hatchback 03.01 80 109 1997, C5 2.0 Hdi (DC4HXB,DC4HXE) Hatchback 04.01 98 133 2179, C5 2.2 Hdi (RC4HXE) Hatchback 09.04 98 133 2179, C5 Break 2.0 Hdi(DERHZA,DERHZE) Estate 06.01 79 107 1997, C5 Break 2.2 Hdi(DE4HXB,DE4HXE) Estate 06.01 98 133 2179, C5 Break 2.2 Hdi(RE4HXE) Estate 09.04 98 133 2179, C8 2.0 Hdi MPV 07.02 79 107 1997, C8 2.2 Hdi MPV 07.02 94 128 217;

FIAT: ULYSSE(179AX) 2.0 JTD MPV 05.03 79 107 1997, ULYSSE(179AX) 2.0 JTD MPV 08.02 80 109 1997, ULYSSE(179AX) 2.2 JTD MPV 08.02 94 128 2179;

LANCIA: PHEDRA(179) 2.0 JTD MPV 07.03 79 107 1997, PHEDRA(179) 2.0 JTD(179AXB1A) MPV 09.02 80 109 1997, PHEDRA(179) 2.2 JTD(179AXC1A) MPV 09.02 94 128 2179;

PEUGEOT: 406(8B) 2.2 Hdi FAP Saloon 03.00-05.04 98 133 2179, 406 Break(8E/F) 2.2 HDI FAP Estate 03.00 98 133 2179, 406 Coupe(8C) 2.2 HDI FAP Coupe 03.00 98 133 2179, 607(9D,9U) 2.0 Hdi Saloon 05.00 80 109 1997, 607(9D,9U) 2.2 Hdi Saloon 02.00 98 133 2179, 806 (221) 2.0 Hdi 16V 08.99-08.02 80 109 1997, 807(E) 2.0 HDI FAP MAP 06.02 79 107 1997, 807(E) 2.2 HDI FAP MAP 06.02 94 128 2179

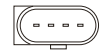

GH5061

REPLACES / REEMPLAZA:

VW: 06A906461B; **HELLA:** 8ET 009 142-261

APPLICATION / APLICACIÓN:

AUDI: A3 (8L1) 1.6 Hatchback 09.96-08.00 74 101 1595, A3 (8L1) 1.6 Hatchback 08.00 75 102 1595, A4 (8D2,B5) 1.6 Saloon 01.95-07.00 74 100 1595, A4 Avant (8D5,B5) 1.6 Estate 03.96-07.00 74 100 1595;

SEAT: CORDOBA(6K2) 1.6 Hatchback 06.99-10.02 74 101 1595, CORDOBA Vario(6K5) 1.6 Estate 06.99 74 101 1595, IBIZA III (6K1) 1.6 Hatchback 08.99-02.02 74 101 1595, LEON (1M1) 1.6 Hatchback 11.99 74 100 1595, TOLEDO II(1M2) 1.6 Saloon 04.99-09.00 74 100 1595;

SKODA: OCTAVIA(1U2) 1.6 Hatchback 02.97 74 101 1595, SKODA OCTAVIA Combi(1U5) 1.6 07.98 74 101 1595;

VW: BORA (1J2) 1.6 Saloon 10.98 74 101 1595, BORA (1J2) 1.6 Saloon 08.00 75 102 1595, BORA Estate (1J5) 1.6 08.00 75 102 1595, BORA Estate(1J6) 1.6 10.98 74 100 1595, GOLF IV(1J1) 1.6 Hatchback 08.00 75 102 1595, GOLF IV(1J1) 1.6 Hatchback 08.97-02.00 74 100 1595, GOLF IV Variant (1J5) 1.6 Estate 08.00 75 102 1595, GOLF IV Variant (1J5) 1.6 Estate 05.99-02.00 74 101 1595, NEW BEETLE (9C1,1C1) 1.6 Hatchback 09.00 75 102 1595, PASSAT(3B2) 1.6 Saloon 10.96-11.00 74 101 1595, PASSAT(3B3) 1.6 Saloon 11.00 75 102 1595, PASSAT(3B3) 2.0 Saloon 11.00 85 115 1984, PASSAT(3B3) 2.0 4 motion 11.00 85 115 1984, PASSAT Variant(3B5) 1.6 Estate 06.97-11.00 74 101 1595, PASSAT Variant(3B6) 1.6 Estate 11.00 75 102 1595, PASSAT Variant(3B6) 2.0 Estate 11.00 85 115 1984, PASSAT Variant(3B6) 2.0 4 motion 11.00 85 115 1984, POLO CLASSIC (6KV2) 100 1.6 Saloon 12.95-09.01 74 100 1595, POLO Variant(6KV5) 1.6 Estate 05.97-09.01 74 101 1595, TRANSPORTER IV Box(70XA) 2.5 08.96 85 115 2461, TRANSPORTER IV Box(70XB,70XC,7DB,7DW) 2.5 Syncro 08.96 85 115 2461, TRANSPORTER IV Bus(70XB,70XC,7DB,7DW) 2.5 08.96 85 115 2461, TRANSPORTER IV Flatbed / Chassis (70XD) 2.5 Syncro 08.96 85 115 2461, TRANSPORTER IV Flatbed / Chassis (70XD) 2.5 Syncro 08.96 85 115 2461

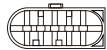

GH5062

REPLACES / REEMPLAZA:

BOSCH: 0 281 002 318; **VW:** 045 906 461

APPLICATION / APLICACIÓN:

SEAT: AROSA (6H) 1.4 TDI Hatchback 01.00 55 75 1422;

VW: LUPO (6X1,6E1) 1.4 TDI Hatchback 01.99 55 75 1422, **VW** LUPO (6N2) 1.4 TDI Hatchback 10.99-09.01 55 75 1422

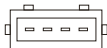

GH5063

REPLACES / REEMPLAZA:

BOSCH: 0 281 217 112; **VW:** 058 133 471 A

APPLICATION / APLICACIÓN:

AUDI: A3 (8L1) 1.8 T Hatchback 12.96 110 150 1781, A4(8D2,B5) 1.8 T Saloon 01.95-11.00 110 150 1781, A4(8D2,B5) 1.8 T Quattro 01.95-11.00 110 150 1781, A4 Avant(8D5,B5) 1.8 T Estate 03.96-09.01 110 150 1781, A4 Avant(8D5,B5) 1.8 T Quattro 01.96-09.01 110 150 1781, A6 (4B,C5) 1.8 T Saloon 01.97 110 150 1781, A6(4B,C5) 1.8 T Quattro 02.97 110 150 1781;

VW: PASSAT(3B2) 1.8 T Saloon 10.96-11.00 110 150 1781, PASSAT Variant (3B5) 1.8 T Estate 06.97-11.00 110 150 1781



GH5064

REPLACES / REEMPLAZA:

BOSCH: 0 280 217 103; **VW:** 037 906 461, 037 906 461A

APPLICATION / APLICACIÓN:

VW: GOLF III(1H1) 1.6 07.95-08.97 74 101 1595, GOLF III Cabriolet(1E7) 1.6 Convertible 10.94-05.98 74 101 1595, GOLF III Variant(1H5) 1.6 Estate 07.94-04.99 74 101 1595, PASSAT (3A2,351) 1.6 Saloon 10.94-08.96 74 101 1595, PASSAT Variant(3A5,351) 1.6 Estate 07.94-12.95 74 101 1595, VENTO(1H2) 1.6 Saloon 10.94-09.98 74 101 1595

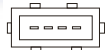

GH5065

REPLACES / REEMPLAZA:

BOSCH: 0 280 217 102; **FIAT:** 4646928; **HYUNDAI:** 28164 22060, 28164 22051; **LANCIA:** 4646928

APPLICATION / APLICACIÓN:

ALFA : 145(930) 1.4 i.e 16V T.S. Hatchback 12.96-01.01 76 103 1370, 146(930) 1.4 i.e 16V T.S Hatchback 11.96-01.01 76 103q 1370;
HYUNDAI: ACCENT(X-3) 1.3 Hatchback 10.94-01.00 44 60 1341, ACCENT(X-3) 1.3 Hatchback 10.94-01.00 55 75 1341, ACCENT(X-3) 1.5 I 12V Hatchback 10.94-01.00 65 88 1495, ACCENT(X-3) 1.5 I 16V 12.95-01.00 73 99 1495, ACCENT Saloon(X-3) 1.3 10.94-01.00 55 75 1341, ACCENT Saloon(X-3) 1.3 10.94-01.00 44 60 1341, ACCENT Saloon(X-3) 1.3 I 12V 10.94-01.00 62 84 1341, ACCENT Saloon(X-3) 1.5 I 12V 10.94-01.00 65 88 1495, ACCENT Saloon(X-3) 1.5 I 16V 10.95-01.00 73 99 1495, S COUPE(SLC) 1.5 I 04.92-05.96 65 98 1495

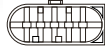

GH5066

REPLACES / REEMPLAZA:

BOSCH: 0 281 002 403; **VW:** 0 59 906 461B

APPLICATION / APLICACIÓN:

AUDI: A4(8D2,B5) 2.5 TDI 09.97-11.00 110 150 2496, A4(8D2,B5) 2.5 TDI quattro 09.97-11.00 110 150 2496, A4 Avant(8D5,B5) 2.5 TDI Estate 09.97-09.01 110 150 2496, A4 Avant(8D5,B5) 2.5 TDI Quattro 09.97-09.01 110 150 2496, A6 Avant(4B,C5) 2.5 TDI Estate 12.97 110 150 2496;
VW: PASSAT (3B2) 2.5 TDI Syncro/4 motion 12.98-11.00 110 150 2496, PASSAT (3B5) 2.5 TDI Syncro/4 motion 12.98-11.00 110 150 2496



GH5068

REPLACES / REEMPLAZA:

BOSCH: 0 281 002 478; **OPEL:** 244 37 502, 93 171 527, 93 171 627

APPLICATION / APLICACIÓN:

OPEL: ASTRA G Estate(F35_) 2.0 DTI 16V 08.99 74 101 1995, ASTRA G Hatchback (F48_,F08_) 2.0 DTI 16V 08.99 74 101 1995, ASTRA G Saloon (F69_) 2.0 DTI 16V 08.99 74 101 1995

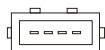

GH5069

REPLACES / REEMPLAZA:

BOSCH: 0 280 217 511; **VOLVO:** 9146483

APPLICATION / APLICACIÓN:

VOLVO: 960 II (964) 2.5 Saloon 07.94-12.96 125 170 2473, 960 II (964) 2.9 Saloon 07.94-12.96 150 204 2922, 960 II Estate (965) 2.5 08.94-12.96 125 170 2473, 960 II Estate (965) 2.9 08.95-12.96 150 204 2922, S90 2.9 Saloon 01.97-05.98 150 204 2922, S90 2.9 Saloon 01.97-05.98 132 180 2922, V90 Estate 2.9 01.97-12.98 132 180 2922, V90 Estate 2.9 01.97-12.98 150 204 2922

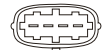

GH5070

REPLACES / REEMPLAZA:

BOSCH: 0 280 217 519; **OPEL:** 90 530 442/90 541 591; **SCANIA:** 4780177

APPLICATION / APLICACIÓN:

OPEL: OMEGA B(25_,26_,27_)2.5 V6 Saloon 03.94-09.00 125 170 2498, OMEGA B(25_,26_,27_)3.0 V6 Saloon 04.94-02.01 155 211 2962, OMEGA B Estate(21_,22_,23_) 2.5 V6 03.94-09.00 125 170 2498, OMEGA B Estate(21_,22_,23_) 3.0 V6 04.94-02.01 155 211 2962, VECTRA B(36_) 2.5 I V6 Saloon 10.95-09.00 125 170 2498, VECTRA B(36_) I 500 2.5 Saloon 05.98-09.00 143 194 2498, VECTRA B Estate(31_) 2.5 I V6 11.96-09.00 125 170 2498, VECTRA B Estate(31_) I 500 2.5 05.98-09.00 143 194 2498, VECTRA B Hatchback(38_) 2.5 I V6 10.95-09.00 125 170 2498;

SAAB: 900 II 2.5- 24 V6 Hatchback 07.93-02.98 125 170 2498, 900 II Convertible 2.5-24 V6 12.93-02.98 125 170 2498;

VAUXH: OMEGA 2.5 V6 Saloon 03.94-09.00 125 170 2498, OMEGA 3.0 V6 Saloon 04.94 155 211 2962, OMEGA Estate 2.5 V6 03.94-09.00 125 170 2498, OMEGA Estate 3.0 V6 04.94 155 211 2962, VECTRA 2.5 I Gsi Saloon 05.98-09.99 143 194 2498, VECTRA 2.5 I V6 10.95-09.00 125 170 2498, VECTRA Estate 2.5 I Gsi 05.98-09.99 143 194 2498, VECTRA Estate 2.5 I V6 11.96-09.00 125 170 2498, VECTRA Hatchback 2.5 I GSI 05.98-09.99 143 194 2498, VECTRA Hatchback 2.5 I V6 10.95-09.00 125 170 2498

GH5071

REPLACES / REEMPLAZA:

BOSCH: 0 280 217 519; **OPEL:** 90 530 442/90 541 591; **SCANIA:** 4780177

APPLICATION / APLICACIÓN:

LAND ROVER: FREELANDER(LN) 2.0 Closed off road 02.98-11.00 72 98 1994, FREELANDER Soft Top Open off road 02.98 72 98 1994



GH5072

REPLACES / REEMPLAZA:

BOSCH: 0 280 218 090; **HYUNDAI:** 28100-39450

APPLICATION / APLICACIÓN:

HYUNDAI: XG 350 Saloon 04.03 145 197 3497;

KIA: OPIRUS 3.5 Saloon 09.03 149 203 3497, **SORENTO (JC)** 3.5 V6 Closed off-Road 08.02 143 194 3497



GH5073

REPLACES / REEMPLAZA:

BOSCH: 0 280 217 003; **OPEL:** 8 36 565, 90 510 153

APPLICATION / APLICACIÓN:

OPEL: ASTRA F Convertible(53_B) 2.0 03.93-10.94 85 115 1998, ASTRA F Estate(51_52_) 2.0 09.91-07.94 85 115 1998, ASTRA F Hatchback(53_54_58_59_) 2.0i 09.91-01.98 85 115 1998, ASTRA F(56_57_) 2.0 I Saloon 03.92-09.98 85 115 1998, FRONTERA A(5_MWL4) 2.2 i(54MWL4) off road 03.95-10.98 100 136 2198;

VAUXH: ASTRA Mk III 2.0 I Saloon 03.92-09.98 85 115 1998, ASTRA Mk III convertible 2.0 I 03.93-10.94 85 115 1998, ASTRA Mk III Estate 2.0 I 09.91-02.98 85 115 1998, ASTRA Mk III Estate 2.0 I 09.91-02.98 85 115 1998, ASTRA Mk III Hatchback 2.0 I 09.91-02.98 85 115 1998, FRONTERA Sport 2.0 I Open off road Vehicle 03.92-10.98 85 115 1998, FRONTERA 2.2 I Closed off road Vehicle 03.95-10.98 100 136 2198

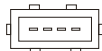

GH5074

REPLACES / REEMPLAZA:

BOSCH: 0 280 218 001; **FIAT:** 46469917; **ALFA ROMEO:** 46469917; **LANCIA:** 46469917

APPLICATION / APLICACIÓN:

ALFA: 145(930) 1.4 i.e 16V T.S. Hatchback 12.96-01.01 76 103 1370, ALFA 145(930) 1.4 i.e 16V T.S. Hatchback 11.96-01.01 76 103 1370



GH5075

REPLACES / REEMPLAZA:

BOSCH: 0 281 002 757; **FORD:** 1051396, 95VW 12B529 BB, 95VW 12B529 BC, 038 906 461C, 06A 906 461

APPLICATION / APLICACIÓN:

AUDI: A3(8L1) 1.9 TDI Hatchback 09.96-07.01 66 90 1896, A3(8L1) 1.9 TDI Hatchback 10.00 74 100 1896, A3(8L1) 1.9 TDI Hatchback 08.97-07.01 81 110 1896, A4(8E2,B6) 1.9TDI Saloon 05.01 74 101 1896;

FORD: GALAXY(WGR) 1.9 TDI MPV 03.95 66 90 1896, GALAXY(WGR) 1.9 TDI MPV 08.97-04.00 81 110 1896, GALAXY(WGR) 1.9 TDI MPV 04.00 85 115 1896;

SEAT: ALHAMBRA (7V8,7V9) 1.9 TDI MPV 04.96 66 90 1896, ALHAMBRA (7V8,7V9) 1.9 TDI MPV 06.00 85 115 1896, ALHAMBRA (7V8,7V9) 1.9 TDI MPV 08.96-06.00 81 110 1896, OCTAVIA(1U2) 1.9 TDI Hatchback 08.97 81 110 1896, OCTAVIA(1U2) 1.9 TDI Hatchback 09.96 66 90 1896, OCTAVIA 1896, LEON(1M1) 1.9 TDI Hatchback 11.99 66 90 1896, LEON(1M1) 1.9 TDI Hatchback 11.99 81 110 1896, TOLEDO II(1M2) 1.9 TDI Saloon 04.99 81 110 1896, TOLEDO II(1M2) 1.9 TDI Saloon 04.99 66 90 1896;

SKODA: FABIA(6Y2) 1.9 TDI Hatchback 01.00 74 100 1896, FABIA combi(6Y5) 1.9 TDI Estate 04.00 74 100 1896, FABIA Saloon(6Y3) 1.9 TDI Saloon 01.00 74 100 1896, OCTAVIA(1U2) 1.9 TDI Hatchback 01.00 74 100 1896, OCTAVIA(1U2) 1.9 TDI Hatchback 09.96 66 90 1896, OCTAVIA combi(1U5) 1.9 TDI Estate 07.98 66 90 1896, OCTAVIA combi(1U5) 1.9 TDI Estate 07.98 81 110 1896, OCTAVIA combi(1U5) 1.9 TDI 4x4 Estate 09.00 74 100 1896, OCTAVIA combi(1U5) 1.9 TDI 4x4 Estate 11.99-09.00 66 90 1896;

VW: BORA(1J2) 1.9 TDI Saloon 09.00 74 101 1896, BORA(1J2) 1.9 TDI Saloon 10.98-06.01 81 110 1896, BORA(1J2) 1.9 TDI Saloon 10.98-06.01 66 90 1896, BORA(1J2) 1.9 TDI Saloon 12.98-06.01 85 115 1896, BORA(1J2) 1.9 TDI 4Motion Saloon 09.00 74 101 1896, BORA(1J2) 1.9 TDI 4Motion Saloon 02.99-06.01 85 115 1896, BORA(1J2) 1.9 TDI 4Motion Saloon 02.99-06.01 66 90 1896, BORA Estate(1J6) 1.9 TDI 09.00 74 101 1896, BORA Estate(1J6) 1.9 TDI 05.99-06.01 81 110 1896, BORA Estate(1J6) 1.9 TDI 05.99-06.01 66 90 1896, BORA Estate(1J6) 1.9 TDI 05.99-06.01 85 115 1896, BORA Estate(1J6) 1.9 TDI 4Motion 05.99-06.01 85 115 1896, BORA Estate(1J6) 1.9 TDI 4Motion 09.00 74 101 1896, GOLF IV(1J1) 1.9 TDI Hatchback 09.00 74 101 1896, GOLF IV(1J1) 1.9 TDI Hatchback 08.97-05.04 81 110 1896, GOLF IV(1J1) 1.9 TDI Hatchback 08.97-06.01 66 90 1896, GOLF IV(1J1) 1.9 TDI Hatchback 08.97-06.01 66 90 1896, GOLF IV(1J1) 1.9 TDI Hatchback 12.98-06.01 85 115 1896, GOLF IV(1J1) 1.9 TDI 4motion Hatchback 09.00 74 101 1896, GOLF IV(1J1) 1.9 TDI 4motion Hatchback 04.98-06.01 66 90 1896, GOLF IV(1J1) 1.9 TDI 4motion Hatchback 09.99-06.01 85 115 1896, GOLF IV Variant(1J5) 1.9 TDI Estate 09.00 74 101 1896, GOLF IV Variant(1J5) 1.9 TDI Estate 08.99-06.01 85 115 1896, GOLF IV Variant(1J5) 1.9 TDI Estate 05.99-06.01 81 110 1896, GOLF IV Variant(1J5) 1.9 TDI Estate 05.99-06.01 66 90 1896, GOLF IV Variant(1J5) 1.9 TDI 4motion Estate 05.99-06.01 85 115 1896, GOLF IV Variant(1J5) 1.9 TDI 4motion Estate 05.99-06.01 66 90 1896, NEW BEETLE(9C1,1C1) 1.9 TDI Hatchback 01.98-02.01 66 90 1896, POLO(9N_) 1.4 TDI Hatchback 10.01 55 75 1422, POLO(9N_) 1.9 TDI Hatchback 10.01 74 101 1896, SHARAN(7M8,7M9,7M6) 1.9 TDI Mpv 04.00 85 115 1896, SHARAN(7M8,7M9,7M6) 1.9 TDI Mpv 09.96-04.00 81 110 1896, SHARAN(7M8,7M9,7M6) 1.9 TDI Mpv 09.95 66 90 1896, SHARAN(7M8,7M9,7M6) 1.9 TDI 4 motion Mpv 04.00 85 115 1896

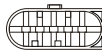

GH5076

REPLACES / REEMPLAZA:

BOSCH: 0 281 002 463; **VOLKSWAGEN:** 038 906 461

APPLICATION / APLICACIÓN:

SKODA: SUPERB(3U4) 1.9 TDI Saloon 08.02.74 101 1896;

VW: LT 28-35 II Bus(2DM) 2.5 TDI Bus 05.01.61 83 2461, LT 28-35 II Bus(2DM) 2.5 TDI Bus 05.99.80 109 2461, LT 28-35 II Bus(2DM) 2.5 TDI Bus 05.01.70 95 2461, LT 28-46 II Box(2DX0AE) 2.5 TDI Box 05.99.80 109 2461, LT 28-46 II Box(2DX0AE) 2.5 TDI Box 05.01.70 95 2461, LT 28-46 II Box(2DX0AE) 2.5 TDI Box 05.01.61 83 2461, LT 28-46 II Flatbed/Chassis(2DX0FE) 2.5TDI 05.01.61 83 2461, LT 28-46 II Flatbed/Chassis(2DX0FE) 2.5TDI 05.99.80 109 2461, PASSAT (3B3) 1.9 TDI Saloon 11.00-05.05 74 101 1896, PASSAT Variant(3B6) 1.9 TDI Estate 11.00-05.05 74 101 1896, TRANSPORTER IV Box (70XA) 2.5TDI 12.98.65 88 2461, TRANSPORTER IV Box (70XA) 2.5TDI 09.95.75 102 2461, TRANSPORTER IV Box (70XA) 2.5TDI Syncro 09.95.75 102 2461, TRANSPORTER IV Bus(70XB,70XC,7DB,7DW)2.5TDI 09.95.75 102 2461, TRANSPORTER IV Bus(70XB,70XC,7DB,7DW)2.5TDI 05.98.65 88 2461, TRANSPORTER IV Bus(70XB,70XC,7DB,7DW)2.5TDI 01.96.75 102 2461, TRANSPORTER IV Flatbed/Chassis (70XD) 2.5TDI 05.98.65 88 2461, TRANSPORTER IV Flatbed/Chassis (70XD) 2.5TDI 09.95.75 102 2461, TRANSPORTER IV Flatbed/Chassis (70XD) 2.5TDI 09.95.75 102 2461, TRANSPORTER IV Flatbed/Chassis (70XD) 2.5TDI 05.98.75 102 2461



GH5077

REPLACES / REEMPLAZA:

BOSCH : 0 281 002 613; **FIAT:** 46784582, 517745310

APPLICATION / APLICACIÓN:

FIAT: DOBLÒ Cargo (223) 1.3 JTD 16V Box 05.04.51 70 1248, IDEA 1.3 JTD MPV 01.04.51 70 1248, PANDA (169) 1.3 JTD Hatchback 09.03.51 70 1248, PANDA (169) 1.3 JTD 4X4 Hatchback 10.04.51 70 1248, PUNTO (188) 1.3 JTD 16V 06.03.51 70 1248;

LANCIA: MUSA 1.3 Multijet 10.04.51 70 1248, MUSA 1.4 MPV 09.05.57 78 1368, MUSA 1.4 MPV 10.04.70 95 1368, YPSILON 1.3 JTD 10.03.51 70 1248



GH5078

REPLACES / REEMPLAZA:

BOSCH : 0 281 002 531; **VW:** 038 906 461B

APPLICATION / APLICACIÓN:

AUDI: A3(8L1) 1.9 TDI Hatchback 10.00.77 100 1896, A3(8P1) 1.9 TDI Hatchback 05.03.77 105 1896, A3 Sportback(8PA) 1.9 TDI Hatchback 09.04.77 105 1896, A4(8E2,B6) 1.9 TDI Saloon 05.01-12.04 74 101 1896, A4 Avant(8E5,B6) 1.9 TDI Estate 11.01-12.04 74 101 1896;

SEAT: ALTEA (5P1) 1.9 TDI MPV 04.04.77 105 1896, CORDOBA(6L2) 1.4 TDI Saloon 05.05.51 70 1422, CORDOBA(6L2) 1.4 TDI Saloon 06.05.59 80 1422, CORDOBA(6L2) 1.4 TDI Saloon 10.02.55 75 1422, CORDOBA(6L2) 1.4 TDI Saloon 09.02.74 100 1896, IBIZA IV (6L1) 1.4 TDI Hatchback 06.05.59 80 1422, IBIZA IV (6L1) 1.4 TDI Hatchback 05.02.55 75 1422, IBIZA IV (6L1) 1.4 TDI Hatchback 05.05.51 70 1422, IBIZA IV (6L1) 1.9 TDI Hatchback 02.02.74 100 1896, LEON (1M1) 1.9 TDI Hatchback 11.99.66 90 1896, LEON (1M1) 1.9 TDI Hatchback 10.05.74 100 1896, LEON (1M1) 1.9 TDI Hatchback 11.99.81 110 1896, LEON (1P1) 1.9 TDI Hatchback 09.95.77 105 1896, TOLEDO II(1M2) 1.9 TDI Saloon 04.99.66 90 1896, TOLEDO II(1M2) 1.9 TDI Saloon 04.99.81 110 1896, TOLEDO III(5P2) 1.9 TDI MPV 10.04.77 105 1896;

SKODA: OCTAVIA (1Z3) 1.9 TDI Hatchback 06.04.77 105 1896, OCTAVIA Combi(1Z5) 1.9 TDI Estate 06.04.77 105 1896, OCTAVIA Combi(1Z5) 1.9 TDI 4X4 Estate 11.04.77 105 1896, ROOMSTER(5J) 1.4 TDI MPV 09.06.59 80 1422, ROOMSTER(5J) 1.4 TDI MPV 09.06.51 70 1422, ROOMSTER(5J) 1.9 TDI MPV 09.06.77 105 1896;

VW: BORA (1J2) 1.9 TDI Saloon 09.00-05.05 74 101 1896, BORA (1J2) 1.9 TDI 4 motion Saloon 09.00-05.05 74 101 1896, BORA Estate (1J6) 1.9 TDI Estate 09.00-05.05 74 101 1896, BORA Estate (1J6) 1.9 TDI 4 motion 09.00-05.05 74 101 1896, CADDY III Box(2KA) 1.9 TDI 04.04.77 105 1896, CADDY III Estate (2KB) 1.9 TDI 04.04.77 105 1896, CADDY III Estate (2KB) 1.9 TDI 09.05.55 75 1896, FOX (5Z1) 1.4 TDI Hatchback 04.05.51 70 1422, GOLF IV (1J1) 1.9 TDI Hatchback 09.00-06.05 74 101 1896, GOLF IV (1J1) 1.9 TDI 4 motion Hatchback 09.00-06.05 74 101 1896, GOLF IV (1J1) Variant (1J5) 1.9 TDI 09.00.74 101 1896, GOLF IV Variant(1J5) 1.9 TDI 4motion 09.00.74 101 1896, GOLF V (1K1) 1.9 TDI Hatchback 10.03.77 105 1896, GOLF V (1K1) 1.9 TDI Hatchback 05.04.66 90 1896, GOLF V (1K1) 2.0 SDI Hatchback 01.04.55 75 1968, GOLF V (1K1) 2.0 TDI Hatchback 10.03.100 136 1968, GOLF V (1K1) 2.0 TDI 16V Hatchback 10.03.103 140 1968, GOLF V PLUS (5M1) 1.9 TDI Hatchback 05.05.66 90 1896, GOLF V PLUS (5M1) 1.9 TDI Hatchback 01.05.77 105 1896, JETTA III (1K2) 1.9 TDI Saloon 09.05.77 105 1896, JETTA III (1K2) 2.0 TDI 16V Saloon 08.05.103 140 1968, MULTIVAN V (7HM) 1.9 TDI MPV 04.03.77 105 1896, NEW BEETLE(9C1,1C1) 1.9 TDI Hatchback 02.01.74 101 1896, NEW BEETLE Convertible (1Y7) 1.9 TDI 07.05.77 105 1896, PASSAT (3C2) 1.9 TDI Saloon 03.05.77 105 1896, PASSAT Variant (3C5) 1.9 TDI Estate 08.05.77 105 1896, POLO (9N_) 1.4 TDI Hatchback 10.01.55 75 1422, POLO (9N_) 1.4 TDI Hatchback 04.05.51 70 1422, POLO (9N_) 1.4 TDI Hatchback 04.05.59 80 1422, POLO (9N_) 1.4 TDI Hatchback 10.01.74 101 1896, POLO Saloon 1.4 TDI Saloon 07.03.55 75 1422, TOURAN 1.9 TDI MPV 02.03.74 100 1896, TOURAN 1.9 TDI MPV 11.04.66 90 1896, TOURAN 1.9 TDI MPV 08.03.77 105 1896, TRANSPORTER V Box (7HA,7HH) 1.9 TDI 04.03.77 105 1896, TRANSPORTER V Box (7HA,7HH) 1.9 TDI 04.03.63 85 1896, TRANSPORTER V Bus(7HB,7HJ) 1.9 TDI 04.03.63 85 1896, TRANSPORTER V Flatbed/Chassis(7JD,7JE,7JL)1.9 TDI 06.06.75 102 1896, TRANSPORTER V Flatbed/Chassis(7JD,7JE,7JL)1.9 TDI 04.03.63 85 1896, TRANSPORTER V Flatbed/Chassis(7JD,7JE,7JL)1.9 TDI 04.03.77 105 1896, TRANSPORTER V Flatbed/Chassis(7JD,7JE,7JL)2.5TDI 04.03.128 174 2461, TRANSPORTER V Flatbed/Chassis(7JD,7JE,7JL)2.5TDI 04.03.96 130 2461, TRANSPORTER V Flatbed/Chassis(7JD,7JE,7JL)2.5TDI 04.03.96 130 2461



GH5079

REPLACES / REEMPLAZA:

BOSCH: 0 281 002 281, 0 281 002 282; **MERCEDES:** 0041530628

APPLICATION / APLICACIÓN:

MERCEDES: A-CLASS(W168) A 160 CDI (168.006) Hatchback 02.01-08.04 55 75 1689, A-CLASS(W168) A 160 CDI (168.007) Hatchback 07.98-02.01 44 60 1689, A-CLASS(W168) A 170 CDI (168.008) Hatchback 07.98-02.01 66 90 1689, A-CLASS(W168) A 170 CDI (168.009,168.109) 02.01-08.04 70 95 1689, Vaneo (414) 1.7 CDI (414.700) MPV 02.02.55 75 1689, Vaneo (414) 1.7 CDI (414.700) MPV 02.02.67 91 1689

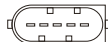



GH5080

REPLACES / REEMPLAZA:

BOSCH: 0 281 002 184; **CITROËN:** 1192 W5; **FIAT:** 13243690, 13244369080, 717359980; **IVECO:** 5045051082; **OPEL:** 90 528 435, 91 93 533; **PEUGEOT:** 1192 W5

APPLICATION / APLICACIÓN:

CITROËN: JUMPER Box(230L) 2.8Hdi 09.00-04.02 94 128 2798, JUMPER Box(230L) 2.8Hdi 4x4 09.00-04.02 94 128 2798, JUMPER Box(244) 2.8 Hdi 04.02 94 128 2798, JUMPER Box(244) 2.8 Hdi 05.04 107 146 2798, JUMPER Box(244) 2.8 Hdi 4x4 04.02 94 128 2798, JUMPER Bus(230P) 2.8 Hdi 09.00-04.02 94 128 2798, JUMPER Bus(230P) 2.8 Hdi 4x4 09.00-04.02 94 128 2798, JUMPER Bus(244.Z_) 2.8 Hdi 04.02 94 128 2798, JUMPER Flatbed/Chassis(230) 2.8 Hdi 09.00-04.02 94 128 2798, JUMPER Flatbed/Chassis(244) 2.8 Hdi 04.02 94 128 2798, JUMPER Flatbed/Chassis(244) 2.8 Hdi 05.04 107 146 2800;

FIAT: DUCATO Box (230L) 2.8 JTD 11.00-04.02 94 128 2798, DUCATO Box (230L) 2.8 JTD 4x4 11.00-04.02 94 128 2798, DUCATO Box (244) 2.8 JTD 04.02 94 128 2798, DUCATO Box (244) 2.8 JTD 4x4 07.02 94 128 2798, DUCATO Bus (230) 2.8 JTD 11.00-04.02 94 128 2798, DUCATO Bus (230) 2.8 JTD 4x4 11.00-04.02 94 128 2798, DUCATO Bus (244.Z_) 2.8 JTD 04.02 94 128 2798, DUCATO Bus (244.Z_) 2.8 JTD 4x4 07.02 94 128 2798, DUCATO Flatbed/Chassis (230) 2.8 JTD 11.00-04.02 94 128 2798, DUCATO Flatbed/Chassis (244) 2.8 JTD 04.02 94 128 2798, DUCATO Flatbed/Chassis (244) 2.8 JTD 4x4 10.02 94 128 2798;

OPEL: FRONTERA B(6B_) 2.2 DTI closed off road 09.02 88 120 2171, FRONTERA B(6B_) 2.2 DTI(6B_ZC,6B_VF,6B_66, 10.98-09.02 85 116 2171, 6B_76) closed off road;

VAUXH: VECTRA Hatchback 2.6 I V6 09.00 125 170 2597, OMEGA 2.6 V6 Saloon 09.00 132 180 2597, VECTRA Estate 2.6 I V6 09.00 125 170 2597, VECTRA 2.6 I V6 Saloon 09.00 125 170 2597, OMEGA Estate 2.6 V6 09.00 132 180 2597, OMEGA 3.2 V6 Saloon 02.01 160 218 3175, OMEGA 3.2 V6 Estate 02.01 160 218 3175, SINTRA 2.2 Dti MPV 07.97-04.99 85 116 2171

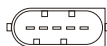

GH5081

REPLACES / REEMPLAZA:

BOSCH: 0 281 002 535; **MERCEDES:** 646 094 00 48

APPLICATION / APLICACIÓN:

MERCEDES: C-CLASS(W203) C 200 CDI Saloon Model Year KW HP cc, C-CLASS(W203) C 200 CDI (203.007) Saloon 02.01 75 102 2148, C-CLASS(W203) C 220 CDI (203.008) Saloon 04.03 90 122 2148, C-CLASS(W203) C 30 CDI AMG(203.018) Saloon 02.04 110 150 2148, C-CLASS Coupe(CL203) C 200 CDI (203.707) 01.03 170 231 2950, C-CLASS Coupe(CL203) C 220 CDI (203.708) 07.03 90 122 2148, C-CLASS Coupe(CL203) C 30 CDI AMG(203.718) 02.04 110 150 2148, C-CLASS T-model (S203) C200 CDI Estate 09.02 170 231 2950, C-CLASS T-model (S203) C200 CDI(203.207) 03.01 75 102 2148, C-CLASS T-Model (S203) C220 CDI (203.208) 04.03 90 122 2148, C-CLASS T-Model (S203) C 30 CDI AMG(203.218) 02.04 110 150 2148, CLK(C209) 220 CDI (209.308) Coupe 01.03 170 231 2950, E-CLASS(W211) 200 CDI (211.007) Saloon 01.05 110 150 2148, E-CLASS(W211) E 200 CDI (211.004) Saloon 04.06 100 136 2148, E-CLASS(W211) E 200 CDI (211.004) Saloon 07.02 75 102 2148, E-CLASS(W211) E 220 CDI (211.006) Saloon 07.02 90 122 2148, E-CLASS(W211) E 220 CDI (211.008) Saloon 03.02 110 150 2148, E-CLASS(W211) E 270 CDI (211.016) Saloon 04.06 125 170 2148, E-CLASS(W211) E 280 CDI (211.023) Saloon 03.02 130 177 2685, E-CLASS(W211) E 320 CDI (211.026) Saloon 05.04 130 177 3222, E-CLASS T-Model(S211) E220 T CDI (211.206) 11.02 150 204 3222, E-CLASS T-Model(S211) E220 T CDI (211.208) 03.03 110 150 2148, E-CLASS T-Model(S211) E270 T CDI (211.216) 04.06 125 170 2148, E-CLASS T-Model(S211) E280 T CDI (211.223) 03.03 130 177 2685, E-CLASS T-Model(S211) E320 T CDI (211.226) 05.04 130 177 3222, S-CLASS (W220) S 320 CDI (220.025,220.1250 03.03 150 224 3222, 09.02-08.05 150 204 3222



GH5082

REPLACES / REEMPLAZA:

HELLA: 8ET 009 142-441; **SIEMENS:** 5WK9643Z; **HYUNDAI:** 28164-37200

APPLICATION / APLICACIÓN:

HYUNDAI: COUPE (GK) 2.7 V6 SANTA F (SM) 2.7 V6 4x4 Close off road Vehicle 03.02 123 167 2656, SONATA III(EF) 2.5 V6 24V Saloon 02.01 127 173 2656, SONATA IV 2.7 V6 Saloon 06.98-10.01 118 160 2493, TRAJET (FO) 2.7 V6 MPV 10.01 127 173 2656, TUCSON(JM) 2.7 All wheel Drive 09.00 127 173 2656, XG 25 Saloon 08.04 129 175 2656;

KIA: MAGENTIS (GD) 2.5 V6 Saloon 05.01 124 169 2493, SPORTAGE 2.7 V6 4WD Closed off road vehicle 09.04 129 175 2656



GH5083

REPLACES / REEMPLAZA:

BOSCH: 0 280 218 023; **VW:** 06A 906 461C

APPLICATION / APLICACIÓN:

AUDI: A3 (8L1) 1.8 T Hatchback Model Year KW HP cc, A3 (8L1) 1.8 T Hatchback 12.96 110 150 1781, A3 (8L1) 1.8 T quattro Hatchback 12.98 132 180 1781, A3 (8L1) 1.8 T quattro Hatchback 10.98 132 180 1781, TT (8N3) 1.8 T Coupe 12.96 110 150 1781, TT (8N3) 1.8 T quattro Coupe 10.98 132 180 1781, TT Roadster (8N9) 1.8 T Convertible 10.98 132 180 1781;

VW: GOLF IV Cabriolet (1E7) 2.0 Convertible 06.98-06.02 85 115 1984, PASSAT (3B2) 1.8 T Saloon 10.96-11.00 110 150 1781



GH5084

REPLACES / REEMPLAZA:

BOSCH: 0 281 002 600; **HYUNDAI:** 28164-27900

APPLICATION / APLICACIÓN:

HYUNDAI: TUSCUN(JM) 2.0 CRD I 08.04 83 113 1991, TUSCUN(JM) 2.0 CRD I All-wheel Drive 08.04 83 113 1991



GH5085

REPLACES / REEMPLAZA:

BOSCH: 0 281 002 447; **HYUNDAI :** 28164-27000

APPLICATION / APLICACIÓN:

HYUNDAI: TRAJET(FO) 2.0 CRDi MPV 04.01.83.113.1991, SANTAF (SM) 2.0 CRDi 4x4 Closed off road 04.01.83.113.1991, SANTAF (SM) 2.0 CRDi 4x4 Closed off road 08.01.83.113.1991;

KIA: CARENS II(FJ) 2.0 CRDi MPV 07.02.83.113.1991

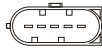

GH5086

REPLACES / REEMPLAZA:

HYUNDAI: 28164 23700; **SIEMENS:** 5WK96431

APPLICATION / APLICACIÓN:

HYUNDAI: LANTRA II(J-2) 2.0 16V 08.96-09.00.102.139.1975, COUPE(RD) 2.0 16V 08.96-04.02.102.139.1975, TRAJET (FO) 2.0 MPV 03.00.100.136.1997, COUPE(RD) 2.0 16V 03.01-04.02.99.135.1975, TUSCON(JM) 2.0 All-Wheel Drive Closed offroad 08.04.104.141.1975, TUSCON(JM) 2.0 All-Wheel Drive Closed offroad 08.04.104.141.1975;

KIA: SPORTAGE 2.0 16V Closed off road Vehicle 09.04.104.141.1975



GH5087

REPLACES / REEMPLAZA:

VW: 037 906 461B; **HELLA:** 8ET 009 142-211; **HITACHI:** AFH62010A

APPLICATION / APLICACIÓN:

AUDI: A4(8D2,B5) 1.6 Saloon 01.95-07.00.74.100.1595, A4(8D2,B5) 1.8,1.8 Quattro Saloon 01.95-11.00.92.125.1781, A4 Avant (8D5,B5) 1.6 Estate 03.96-07.00.74.100.1595, A4 Avant (8D5,B5) 1.8 Estate 02.96-09.01.92.125.1781, A4 Avant(8D5,B5) 1.8 Quattro Estate 01.96-09.01.92.125.1781, A6 (4A,C4) 1.8 Saloon 12.95-02.97.92.125.1781, A6 (4A,C4) 1.8 quattro Saloon 12.95-02.97.92.125.1781, A6 Avant (4A,C4) 1.8,1.8 quattro Estate 12.95-12.97.92.125.1781;

SEAT: ALHAMBRA(7V8,7V9) 2.0 I MPV 04.96.85.115.1984, CORDOBA(6K2/C2) 1.6 I Saloon 07.96-06.99.74.101.1595, CORDOBA(6K2/C2) 2.0 I Saloon 02.93-06.99.85.115.1984, CORDOBA Vario(6K5) 1.6 I Estate 09.96-06.99.74.101.1595, IBIZA II (6K1) 1.6 I Hatchback 04.96-08.99.74.101.1595, IBIZA II (6K1) 2.0 I Hatchback 03.93-08.99.85.115.1984, TOLEDO I (1L) 1.6 I Hatchback 11.96-03.99.74.101.1595, TOLEDO I(1L) 2.0 I Hatchback 05.91-03.99.85.115.1984;

VW: CORRADO (531) 2.0 I Coupe 04.93-12.95.85.115.1984, GOLF III (1H1) 1.6 Hatchback 07.95-08.97.74.101.1595, GOLF III (1H1) 2.0 Hatchback 11.91-08.97.85.115.1984, GOLF III (1H1) 2.0 Syncro(1HX1) Hatchback 08.95-08.97.85.115.1984, GOLF III Cabriolet(1E7) 1.6 Convertible 10.94-05.98.74.101.1595, GOLF III Cabriolet(1E7) 2.0 Convertible 07.93-05.98.85.115.1984, GOLF III Variant (1H5) 1.6 Estate 07.94-04.99.74.101.1595, GOLF III Variant (1H5) 2.0 Estate 07.93-04.99.85.115.1984, GOLF III Variant (1H5) 2.0 Syncro Estate 08.95-04.99.85.115.1984, GOLF IV Cabriolet (1E7) 1.6 Convertible 06.98-06.02.74.100.1595, GOLF IV Cabriolet (1E7) 2.0 Convertible 06.98-06.02.85.115.1984, PASSAT (3A2,351) 1.6 Saloon 10.94-08.96.74.101.1595, PASSAT (3A2,351) 2.0 Saloon 03.95-08.96.79.107.1984, PASSAT (3A2,351) 2.0 Syncro 10.90-08.96.85.115.1984, PASSAT Variant(3A5,351) 1.6 Estate 07.94-12.95.74.101.1595, PASSAT Variant(3A5,351) 2.0 Estate 02.90-05.97.85.115.1984, PASSAT Variant(3A5,351) 2.0 Estate 03.95-08.96.79.107.1984, PASSAT Variant(3A5,351) 2.0 Syncro 10.90-05.97.85.115.1984, POLO CLASSIC(6KV2) 100 1.6 Saloon 12.95-09.01.74.100.1595, POLO Variant (6KV5) 1.6 Estate 05.97-09.01.74.101.1595, SHARAN(7M8,7M9,7M6) 2.0 MPV 09.95.85.115.1984, VENTO(1H2) 2.0 Saloon 11.91-09.98.85.115.1984



GH5088

REPLACES / REEMPLAZA:

VW: 058 133 471; **HELLA:** 8ET 009 142-251; **HITACHI:** AFH6010B

APPLICATION / APLICACIÓN:

AUDI: A3(8L1) 1.6 Hatchback 09.96-08.00.74.101.1595, A3(8L1) 1.8 Hatchback 09.96.92.125.1781, A4(8D2,B5) 1.6 Saloon 01.95-07.00.74.100.1595, A4(8D2,B5) 1.8 Saloon 01.95-11.00.92.125.1781, A4(8D2,B5) 1.8 Quattro 01.95-11.00.92.125.1781, A4 Avant(8D5,B5) 1.6 Estate 03.96-07.00.74.100.1595, A4 Avant(8D5,B5) 1.8 Estate 02.96-09.01.92.125.1781, A4 Avant(8D5,B5) 1.8 quattro 01.96-09.01.92.125.1781, A6 (4B,C5) 1.8 Saloon 07.97-01.05.92.125.1781, A6 Avant(4B,C5) 1.8 Estate 12.97-01.05.92.125.1781, CABRIOLET(8G7,B4) 1.8 Convertible 01.97-08.00.92.125.1781;

VW: PASSAT (3B2) 1.6 Saloon 10.96-11.00.74.101.1595, PASSAT (3B2) 1.8 Saloon 10.96-11.00.92.125.1781, PASSAT Variant 1.8 Syncro/4motion 10.96-11.00.92.125.1781, PASSAT Variant (3B5) 1.6 Estate 06.97-11.00.74.101.1595, PASSAT Variant (3B5) 1.8 Estate 06.97-11.00.92.125.1781, PASSAT Variant (3B5) 1.8 Syncro /4motion Estate 06.97-11.00.92.125.1781

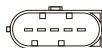

GH5089

REPLACES / REEMPLAZA:

SIEMENS VDO: 5WK9613; **HELLA:** 8ET 009142-331; **MERCEDES:** 111 094 01 48, A 111 094 01 48

APPLICATION / APLICACIÓN:

MERCEDES: C-CLASS(W203) C 180 (203.035) Saloon 10.00-05.02.95.129.1998, C-CLASS(W203) C 200 Kompressor(203.045) 05.00-05.02.120.163.1998, C-CLASS Coupe(CL203) C180 (203.735) 03.01-05.02.95.129.1998, C-CLASS Coupe(CL203)C200Kompressor(203.745) 03.01-05.02.120.163.1998, C-CLASS Coupe(CL203)C200Kompressor(203.747) 03.01-05.02.145.197.2295, C-CLASS Estate(S202) C180 T(202.081) 09.00-03.01.95.129.1998, C-CLASS Estate(S202)C200Tkompressor(202.087) 09.00-03.01.120.163.1998, C-CLASS T-Model(S203) C 180 (203.235) Estate 03.01-05.02.95.129.1998, C-CLASS T-Model(S203)C200kompressor(203.245) 03.01-05.02.120.163.1998, CLK (C208) 200 kompressor(208.344) Coupe 06.00-06.02.120.163.1998, CLK (C208) 230 kompressor(208.348) Coupe 06.00-06.02.145.197.2295, CLK Convertible(A208) 200kompressor(208.444) 06.00-03.02.120.163.1998, CLK Convertible(A208) 230kompressor(208.448) 06.00-03.02.145.197.2295, E-CLASS(W210) E200kompressor(210.048) 08.00-03.02.120.163.1998, E-CLASSEstate (S210)E200Tkompressor(210.248) 08.00-03.03.120.163.1998, SLK(R170) 200kompressor(170.444) convertible 03.00-04.04.120.163.1998, SLK(R170) 230kompressor(170.449) convertible 03.00-04.04.145.197.2295



GH5090

REPLACES / REEMPLAZA:

SIEMENS/VDO: 5WK96132; BMW: 13 62 1 438 871; HELLA: 8ET 0091 142-341

APPLICATION / APLICACIÓN:

BMW: BMW 3 (E46) 330 I Saloon 06.00-02.05 170 231 2979, BMW 3 (E46) 300 XI Saloon 06.00-02.05 170 231 2979, BMW 3 Convertible(E46) 330 Ci 06.00 170 231 2979, BMW 3 Coupe (E46) 330 Ci 06.00 170 231 2979, BMW 3 Touring (E46) 330 I Estate 06.00 170 231 2979, BMW 3 Touring (E46) 330 XI Estate 06.00 170 231 2979, BMW 5 (E39) 530 I Saloon 09.00-06.03 170 231 2979, BMW X5(E53) 3.0 I Closed off road vehicle 05.00 170 231 2979, BMW Z3 3.0 Convertible 06.00 170 231 2979, BMW Z3 Coupe 3.0 06.00 170 231 2979

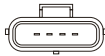

GH5091

REPLACES / REEMPLAZA:

FORD: 1 030 844, 96 FP12B579 AB; PIERBURG: 7.22184.04.0; HELLA: 8ET 009 142-471

APPLICATION / APLICACIÓN:

FORD: FIESTA IV(JA_JB_) 1.4 I 16V Hatchback 04.92-01.02 66 90 1388, FIESTA V(JH_) 1.4 16V Hatchback 11.01 59 80 1388, KA(RB_) 1.3 I Hatchback 09.96 44 60 1299, KA(RB_) 1.3 I Hatchback 09.96 37 50 1299, KA(RB_) 1.3 I Hatchback 06.98 36 49 1299, KA(RB_) 1.3 I Hatchback 08.02 51 70 1299, PUMA(EC_) 1.6 16V Coupe 08.00 76 103 1596



GH5092

REPLACES / REEMPLAZA:

SIEMENS/VDO: 5WK9634; HELLA: 8ET 009 142-371; OPEL: 24404016, 836 595

APPLICATION / APLICACIÓN:

OPEL: SIGNUM 2.2 direct Hatchback 05.03 114 155 2198, VECTRA C 2.2 direct Saloon 10.03 114 155 2198, VECTRA C Estate 2.2 direct 10.03 114 155 2198, VECTRA C GTS 2.2 direct 10.03 114 155 2198, ZAFIRA 2.2 MPV 07.05 114 155 2198;

VAUXH: SIGNUM 2.2 i 05.03 114 155 2198, VECTRA Mk II 2.2 direct Saloon 10.03 114 155 2198, VECTRA Mk II Estate 2.2 direct 10.03 114 155 2198, VECTRA Mk II GTS 2.2 direct 10.03 114 155 2198, ZAFIRA Mk 2.2 07.05 114 155 2198

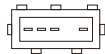

GH5093

REPLACES / REEMPLAZA:

HELLA: 8ET 009 142-171; FORD: 93BB12B579BA, 6 848 047

APPLICATION / APLICACIÓN:

FORD: ESCORT CLASSIC(AAL,ABL) 1.8TD Hatchback 10.98-07.00 66 90 1753, ESCORT CLASSIC Turnier (ANL) 1.8 TD Estate 02.99-07.00 66 90 1753, ESCORT VII (GAL,AAL,ABL) 1.8 16V Hatchback 01.95-10.98 85 115 1796, ESCORT VII (GAL,AAL,ABL) 1.8 16V Hatchback 01.95-10.98 66 90 1753, ESCORT VII Convertible(ALL) 1.8 16V XR3i 10.95-08.98 85 115 1796, ESCORT VII Convertible(ALL) 1.8 TD 09.95-08.98 66 90 1753, ESCORT VII Estate (GAL,ANL) 1.8 16V Estate 01.95-02.99 85 115 1796, ESCORT VII Estate (GAL,ANL) 1.8 TD 01.95-02.99 66 90 1753, ESCORT VII Saloon (GAL,AFL) 1.8 16V 01.95-02.99 85 115 1796, ESCORT VII Saloon (GAL,AFL) 1.8 TD 01.95-02.99 66 90 1753, GALAXY (WGR) 2.0 I MPV 11.95 85 116 1998, GALAXY (WGR) 2.3 16V MPV 01.97 107 146 2295, MONDEO I (GBP) 1.8 I 16V Hatchback 02.93-08.96 85 115 1796, MONDEO I (GBP) 1.8 I 16V Hatchback 07.94-08.96 82 112 1796, MONDEO I (GBP) 1.8 I 16V 4x4 Hatchback 02.93-08.96 85 115 1796, MONDEO I (GBP) 1.8 TD Hatchback 10.95-08.96 66 90 1753, MONDEO I (GBP) 1.8 TD Hatchback 06.93-08.96 65 88 1753, MONDEO I Estate (BNP) 1.8 I 16V 07.94-08.96 82 112 1796, MONDEO I Estate (BNP) 1.8 I 16V 04.93-08.96 85 115 1796, MONDEO I Estate (BNP) 1.8 I 16V 4x4 04.93-08.96 85 115 1796, MONDEO I Estate (BNP) 1.8 TD 11.95-08.96 66 90 1753, MONDEO I Estate (BNP) 1.8 TD 06.93-08.96 65 88 1753, MONDEO I Saloon (GBP) 1.8 I 16V 01.94-08.96 82 112 1796, MONDEO I Saloon (GBP) 1.8 I 16V 02.93-08.96 85 115 1796, MONDEO I Saloon (GBP) 1.8 TD 10.95-08.96 66 90 1753, MONDEO I Saloon (GBP) 1.8 TD 06.93-08.96 65 88 1753, PUMA (EC_) 1.7 16V 03.97 92 125 1679, SCORPIO II (GFR,GGR) 2.0i Saloon 10.94-08.98 85 115 1998, SCORPIO II (GFR,GGR) 2.0i 16V Saloon 10.94-08.98 100 136 1998, SCORPIO II (GFR,GGR) 2.3 I 16V 06.96-08.98 108 147 2295, SCORPIO II Estate (GFR,GGR) 2.3 I 16V 06.96-08.98 108 147 2295, TRANSIT Box(E_) 2.0 (EAL,EAS) 06.94-03.00 84 114 1998, TRANSIT Box(E_) 2.0 (EBL,EBS,ECL,EDS,EGL 09.95-03.00 84 114 1998, ESS,ESL,EUS) , TRANSIT Flabted/Chassis (E_) 2.0 (EME/L/S,ENE/L/S) 08.94-03.00 84 114 1998, FORD Crown Victoria (Exc. Police) 4.6L 2004, Mustang w/o Supercharged Eng 4.6L 2003-2004, Mustang 4.6L 2002, Explorer 4.6L 2004-2005, F150 Pickup 4.6L 2003-2005, E150 Van 4.6L 2000-2003; LINCOLN: Aviator 4.6L 2003-2005, Town Car 4.6L 2003-2004; MERCURY: Grand Marquis 4.6L 2003-2004; USA FORD: Crown Victoria (Exc. Police) 2004 4.6L, Mustang w/o Supercharged Eng 2003>2004 4.6L, Mustang 2002 4.6L, Explorer 2004>2005 4.6L, F150 Pickup 2003>2005 4.6L, E150 Van 2000>2003 4.6L; USA LINCOLN: Aviator 2003>2005 4.6L, Town Car 2003>2004 4.6L; USA MERCURY: Grand Marquis 2003>2004 4.6L



GH5094

REPLACES / REEMPLAZA:

BOSCH: 0 280 218 109; VOLVO: 8670113; RENAULT: 00 08 670 113

APPLICATION / APLICACIÓN:

VOLVO: S80 2.8 T6 Saloon 05.98 200 272 2783

GH5095

REPLACES / REEMPLAZA:

NISSAN: 22680 4M500, 22680 4M501, 22680 2W200, 22680 6N201, 22680 6N200, 22680 AD201, 22680 AD200; **SUBARU:** 22680 AA290

APPLICATION / APLICACIÓN:

NISSAN: MAXIMA QX (A33) 2.0 V6 24V Saloon 03.00 103 140 1995, MAXIMA QX (A33) 3.0 V6 24V Saloon 03.00 147 200 2988, PATROL GR II(Y61) 3.0 DTI Closed off Road Vehicle 05.00 116 158 2953, X-TRAIL (T30) 2.0 4x4 Closed off Road Vehicle 07.01 103 140 1998, X-TRAIL (T30) 2.5 4x4 Closed off Road Vehicle 01.03 121 165 2488;

SUBARU: FORESTER (SF) 2.0 S Turbo Closed off Road Vehicle 06.98-04.01 125 170 1994, IMPREZA (GC) 2.0 I 4WD Saloon 06.98-12.00 92 125 1994



GH5095A

REPLACES / REEMPLAZA:

NISSAN: 22680-AD21A

APPLICATION / APLICACIÓN:

.

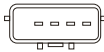

GH5096

REPLACES / REEMPLAZA:

BOSCH: 0 280 218 040

APPLICATION / APLICACIÓN:

NISSAN: MICRA(K11) 1.0 I 16V Hatchback 09.00-02.03 44 60 998, MICRA(K11) 1.4 I 16V Hatchback 09.00-02.03 60 82 1348

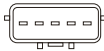

GH5097

REPLACES / REEMPLAZA:

MAZDA: 197400-2010, ZL0113215

APPLICATION / APLICACIÓN:

MAZDA: 3 (BK14) 1.4 Hatchback 02.04 59 80 1388, 3 (BK14) 1.4 Hatchback 10.03 62 84 1349, 3 (BK14) 1.6 Hatchback 10.03 77 105 1598, 3 Saloon(BK12) 1.6 02.04 77 105 1598, 3 Saloon(BK12) 2.0 02.04 110 150 1999, 5 (CR19) 1.8 MPV 03.05 85 116 1798, 5 (CR19) 2.0 MPV 03.05 107 146 1999, 5 (CR19) 2.0 CD MPV 03.05 81 110 1998, 6 (GG) 1.8 Saloon 08.02 88 120 1798, 6 (GG) 2.0 Saloon 06.02 104 141 1999, 6 (GG) 2.0 DI Saloon 08.02 89 121 1998, 6 (GG) 2.3 Saloon 06.02 122 166 2261, 6 Hatchback(GG) 1.8 08.02 88 120 1798, 6 Hatchback(GG) 2.0 08.02 104 141 1999, 6 Hatchback(GG) 2.0 DI 08.02 89 121 1998, 6 Hatchback(GG) 2.0 DI 08.02 100 136 1998, 6 Hatchback(GG) 2.3 08.02 122 166 2261, 6 Station Wagon (GY) 1.8 Estate 08.02 88 120 1798, 6 Station Wagon (GY) 2.0 Estate 08.02 104 144 1999, 6 Station Wagon (GY) 2.0 Di Estate 08.02 100 136 1998, 6 Station Wagon (GY) 2.0 Di Estate 08.02 89 121 1998, 6 Station Wagon (GY) 2.3 Estate 08.02 122 166 2261, MPV II(LW) 2.0 Di 07.02 100 136 1998, MPV II(LW) 2.3 07.02 104 141 2261



GH5098

REPLACES / REEMPLAZA:

ROVER: 197400 3021

APPLICATION / APLICACIÓN:

ROVER

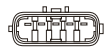

GH5099

REPLACES / REEMPLAZA:

TOYOTA: 197400 2000

APPLICATION / APLICACIÓN:

TOYOTA





GH5100

REPLACES / REEMPLAZA:
 TOYOTA: 22204-22010, 197400 2030C

APPLICATION / APLICACIÓN:

TOYOTA: CELICA (ZZT23_) 1.8 16V VT-I(ZZT230_) Coupe 11.99 105 143 1794, COROLLA Verso(_E12J_) 1.4 VVT-I MPV 01.02-05.04 71 97 1398, COROLLA Verso(_E12J_) 1.6 VVT-I MPV 01.02-05.04 81 110 1598, COROLLA Verso(_E12J_) 1.8 VVT-I MPV 01.02-05.04 99 135 1794, RAV 4 II (XA2) 2.0 VVT I 4WD Colsed off road 06.00 110 150 1998, YARIS (_CP10) 1.0 16V (SCP10_) Hatchback 04.99 50 68 998, YARIS (_CP10) 1.3 16V (NCP10_) Hatchback 11.99 63 86 1299, YARIS (_CP10) 1.4 D-4D Hatchback 12.01 55 75 1364, YARIS VERSO (NC/LP2_) 1.3 (NCP22) MPV 11.99 63 86 1299, YARIS VERSO (NC/LP2_) 1.4 D-4D(NLP22) MPV 12.01 55 75 1364

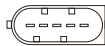

GH5101

REPLACES / REEMPLAZA:

BOSCH: 0 928 400 520; **BMW:** 13 41 2 247 592; **ROVER:** MHK 101130

APPLICATION / APLICACIÓN:

MG: MG ZT 2.0 CD Ti Saloon 06.02-09.03 85 116 1951, MG ZT 2.0 CD Ti Saloon 11.02 96 131 1951, MG ZT-T 2.0 CD Ti Estate 06.02-09.03 85 116 1951, MG ZT-T 2.0 CD Ti Estate 11.02 96 131 1951;

ROVER: 75 (Rj) 2.0 CDT Saloon 02.99 85 115 1950, 75 Tourer(Rj) 2.0 CDT Estate 08.01 96 131 1951, 75 Tourer(Rj) 2.0 CDT Estate 02.03 96 131 1951

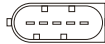

GH5102

REPLACES / REEMPLAZA:

BOSCH: 0 280 217 814; **BMW:** 13 62 1 433 567; **ROVER:** MHK 000230

APPLICATION / APLICACIÓN:

ALPI ROADSTAR: (Z8) 4.8 V8 Convertible 06.02 280 381 4837;

BMW: 5(E39) 540 I Saloon 04.96-06.03 210 286 4398, 5 Touring (E39) 540 I Estate 01.97-05.04 210 286 4398, 7 (E38) 740 I,IL Saloon 01.96-11.01 210 286 4398, X5(E53) 4.4 I Closed off Road Vehicle 05.00 210 286 4398, X5(E53) 4.6 is Closed off Road Vehicle 02.02 255 347 4619;

LAND ROVER: RANGE ROVER III (LM) 4.4 Colsed off Road 03.02 210 286 4398

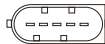

GH5103

REPLACES / REEMPLAZA:

BOSCH: 0 928 400 468; **BMW:** 13622247074, 13627787076, 13712247002

APPLICATION / APLICACIÓN:

BMW: 3(E46) 318 d Saloon 09.01-03.03 85 116 1951, 3(E46) 318 d Saloon 03.03-02.05 85 116 1995, 3(E46) 320 d Saloon 09.01-02.05 110 150 1995, 3(E46) 320 d Saloon 04.98-09.01 100 136 1951, 3(E46) 330 d Saloon 10.99-02.05 135 184 2926, 3(E46) 330 xd Saloon 06.00-02.05 135 184 2926, 3 Compact(E46) 318 td Hatchback 03.03-02.05 85 115 1995, 3 Compact(E46) 320 td Hatchback 09.01-02.05 110 150 1995, 3 Convertible(E46) 320 cd 02.05 110 150 1995, 3 Coupe(E46) 320 Cd 11.03 110 150 1995, 3 Touring(E46) 318 d Estate 03.02 85 115 1951, 3 Touring(E46) 318 d Estate 03.03 85 116 1995, 3 Touring(E46) 320 d Estate 09.01 110 150 1995, 3 Touring(E46) 320 d Estate 03.00-09.01 100 136 1951, 3 Touring(E46) 330 d Estate 10.99 135 184 2926, 3 Touring(E46) 330 Xd Estate 06.00 135 184 2926, 5 (E39) 520 d Saloon 02.00-06.03 100 136 1951, 5 (E39) 525 d Saloon 02.00-06.03 120 163 2497, 5 (E39) 520 d Saloon 09.00-06.03 142 193 2926, 5 Touring (E39) 520 d Estate 02.00-09.03 100 136 1951, 5 Touring (E39) 520 d Estate 02.00-05.04 120 163 2497, 5 Touring (E39) 530 d Estate 09.00-05.04 142 193 2926, 7 (E39) 730 d Saloon 04.00-11.01 142 193 2926, X5(E53) 3.0 d Closed off- Road Vechile 05.01 135 184 2925



GH5105

REPLACES / REEMPLAZA:

HELLA: 8ET009142-051; **ROVER:** MHK100620; **VDO:** 5WK9607

APPLICATION / APLICACIÓN:

LAND ROVER: DEFENDER(LD) 2.5 90 TDI Open off road 09.90 83 113 2495, DEFENDER Station Wagon(LD) 2.5 90,110TDI 09.90-12.98 83 113 2495, DEFENDER Station Wagon(LD) 2.5 Td5 4wd 06.98 90 122 2495, DISCOVERY II(LJ,LT) 2.5 Td5 01.99 102 139 2495, DISCOVERY II(LJ,LT) 2.5 Tdi 10.95 90 122 2496



GH5107

REPLACES / REEMPLAZA:

BOSCH: 0 280 218 117; **NISSAN:** 22680-AU300

APPLICATION / APLICACIÓN:

NISSAN: Almera N16 2000-2006, Avenir 1999-2006, Bluebird 2000-2006, Expert 1999-2006, Primera 2000-2006, Pulsar N16 2000-2006, Sentra B15, N16, Sunny



GH5107A

REPLACES / REEMPLAZA:
BOSCH: 0 280 218 150; **NISSAN:** 22680-8U301
 APPLICATION / APLICACIÓN:
NISSAN: Sentra 1.8 2003>2006



GH5108

REPLACES / REEMPLAZA:
BOSCH: 0 280 217 110; **BMW:** 13 62 1 736 224
 APPLICATION / APLICACIÓN:
BMW: 3 (E36) 318 is Saloon 09.95-02.98 103 140 1895, 3 Compact(E36) 318 TI 07.95-08.00 103 140 1895, 3 Coupe (E36) 318 IS 09.95-04.99 103 140 1895, 7 (E38) 750 i,IL Saloon 12.94-11.01 240 326 5379, 8 (E31) 850 CI 09.94-12.99 240 326 5379, Z3 1.9 Convertible 10.95-03.99 103 140 1895



GH5109

REPLACES / REEMPLAZA:
PIERBURG 7.18221.51.0; **VW:** 074 906 461, 059 145 100 A, 059 145 100 B; **FORD:** 1003751, 95; **VW:** 12B529BA
 APPLICATION / APLICACIÓN:
AUDI: 80 (8C,B4) 1.9 TDI Saloon 09.91-12.94 66 90 1896,80 Avant (8C,B4) 1.9 TDI Estate 07.92-01.96 66 90 1896,A3(8L1) 1.9 TDI Hatchback 09.96-07.01 66 90 1896,A3(8L1) 1.9 TDI Hatchback 08.97-07.01 81 110 1896,A4(8D2,B5) 1.9 TDI Saloon 12.95-11.00 55 75 1896, A4(8D2,B5) 1.9 TDI Saloon 10.95-11.00 81 110 1896,A4(8D2,B5) 1.9 TDI Saloon 01.95-11.00 66 90 1896, A4 Avant (8D5,B5) 1.9 TDI Estate 03.96-09.01 55 75 1896, A4 Avant (8D5,B5) 1.9 TDI Estate 02.96-09.01 81 110 1896, A4 Avant (8D5,B5) 1.9 TDI Estate 02.96-09.01 66 90 1896, A6 (4A,C4) 1.9 TDI Saloon 06.94-02.97 66 90 1896, A6 (4B,C5) 1.9 TDI Saloon 02.97-01.05 81 110 1896,A6 Avant(4A,C4) 1.9 TDI Estate 06.94-12.97 66 90 1896;
FORD: GALAXY(WGR) 1.9 TDI MPV 03.95 66 90 1896, GALAXY(WGR) 1.9 TDI MPV 08.97-04.00 81 110 1896;
SEAT: ALHAMBRA(7V8,7V9) 1.9 TDI MPV 04.96 66 90 1896, ALHAMBRA(7V8,7V9) 1.9 TDI MPV 08.96-06.00 81 110 1896, CORDOBA(6K2/C2) 1.9 SDI Saloon 08.96-06.99 47 64 1896, CORDOBA(6K2/C2) 1.9 TDI Saloon 03.97-06.99 81 110 1896,CORDOBA(6K2/C2) 1.9 TDI Saloon 08.96-06.99 66 90 1896, SEAT CORDOBA(6K5) 1.9 SDI Estate 09.96-06.99 47 64 1896, CORDOBA Vario(6K5) 1.9 TDI Estate 07.97-06.99 81 110 1896, CORDOBA Vario(6K5) 1.9 TDI Estate 08.96-06.99 66 90 1896, IBIZA (6K1) 1.9 SDI Hatchback 08.96-08.99 47 64 1896, IBIZA (6K1) 1.9 TDI Hatchback 02.97-08.99 81 110 1896, IBIZA (6K1) 1.9 TDI Hatchback 08.96-08.99 66 90 1896, INCA(6K9) 1.9 TDI Box 09.96 66 90 1896, TOLEDO I (1L) 1.9TDI Hatchback 11.96-03.99 81 110 1896, TOLEDO I (1L) 1.9 TDI Hatchback 08.95-03.99 66 90 1896;
SKODA: OCTAVIA(1U2) 1.9 TDI Hatchback 08.97 81 110 1896, OCTAVIA(1U2) 1.9 TDI Hatchback 09.96 66 90 1896, OCTAVIA Combi(1U5) 1.9 TDI Estate 07.98 66 90 1896;
VW: CADDY II Estate (9K9B) 1.9 TDI 10.96-01.04 66 90 1896, GOLF III Variant (1H5) 1.9 TDI Estate 04.96-04.99 81 110 1896, GOLF IV (1J1) 1.9 TDI Hatchback 10.97-05.04 66 90 1896, GOLF IV (1J1) 1.9 TDI Hatchback 08.97-05.04 81 110 1896, GOLF IV (1J1) 1.9 TDI 4motion Hatchback 07.98-04.02 66 90 1896, GOLF IV Cabriolet(1E7) 1.9 TDI Convertible 06.98-06.02 81 110 1896, GOLF IV Variant (1J5) 1.9 TDI Estate 05.99-05.06 66 90 1896, GOLF IV Variant (1J5) 1.9 TDI Estate 05.99-06.01 81 110 1896, GOLF IV Variant (1J5) 1.9 TDI 4 motion 05.99-04.02 66 90 1896, LT 28-35 II Bus (2DM) 2.5 SDI 07.96 55 75 2461, LT 28-35 II Bus (2DM) 2.5 TDI 05.96-08.99 75 102 2461, NEW BEETLE(9C1,1C1) 1.9 TDI Hatchback 01.98-02.01 66 90 1896, PASSAT (3A2,351) 1.9 TDI Saloon 03.96-08.96 81 110 1896, PASSAT (3B2) 1.9 TDI Saloon 10.96-11.00 81 110 1896, PASSAT (3B2) 1.9 TDI Saloon 10.96-11.00 66 90 1896, PASSAT (3B2) 1.9 TDI Syncro/4motion 10.96-11.00 81 110 1896, PASSAT (3B2) Variant(3A5,351)1.9 TDI 03.96-05.97 81 110 1896, PASSAT Variant(3A5,351) 1.9 TDI Estate 10.93-05.97 66 90 1896, PASSAT Variant(3B5) 1.9 TDI Estate 06.97-11.00 81 110 1896, PASSAT Variant(3B5) 1.9 TDI Estate 06.97-11.00 66 90 1896, PASSAT Variant(3B5) 1.9 TDI Syncro/4motion 06.97-11.00 81 110 1896, POLO (6N1) 64 1.9 D 10.94-10.99 47 64 1896, POLO (6N1) 1.9 D 10.99-09.01 47 64 1896, POLO Box(6NF) 1.9 D 10.94-12.99 47 64 1896, POLO CLASSIC (6KV2) 110 1.9 TDI 06.98-09.01 81 110 1896, POLO CLASSIC (6KV2) 90 1.9 TDI 09.96-09.01 66 90 1896, POLO Variant(6KV5) 1.9 TDI Estate 05.97-09.01 66 90 1896, POLO Variant(6KV5) 1.9 TDI Estate 06.98-09.01 81 110 1896, SHARAN (7M8,7M9,7M6) 1.9 TDI MPV 09.95 66 90 1896, SHARAN (7M8,7M9,7M6) 1.9 TDI MPV 09.96-04.00 81 110 1896, TRANSPORTER IV Bus (70XB,70XC,7DB,7DW)2.5TDI 09.95-04.03 75 112 2461, TRANSPORTER IV Bus (70XB,70XC,7DB,7DW)2.5TDI Syncro 01.96-04.03 75 112 2461, VENTO (1H2) 1.9 TDI Saloon 09.93-09.98 66 90 1896, VENTO (1H2) 1.9 TDI Saloon 04.96-09.98 81 110 1896



GH5110

REPLACES / REEMPLAZA:
BOSCH: 0 280 217 110; **VW:** 06A 906 461 N
 APPLICATION / APLICACIÓN:
SKODA: SUPERB(3U4) 1.8 T Saloon 02.02 110 150 1781;
VW: PASSAT (3B3) 1.8 T 20V Saloon 11.00-05.05 110 150 1781, PASSAT Variant (3B6) 1.8 T 20V Estate 11.00-05.05 110 150 1781



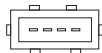

GH5112

REPLACES / REEMPLAZA:

BOSCH: 0 280 217 107; **RENAULT:** 74 03 507 697, 77 00 100 572; **VOLVO:** 1275749, 3507697

APPLICATION / APLICACIÓN:

RENAULT: SAFRANE II(B54_) 2.5 20V(B54F) Hatchback 07.96-12.00 121 165 2435;

VOLVO: 850(LS) 2.0 Saloon 06.91-12.96 105 143 1984, 850(LS) 2.0 Turbo Saloon 08.93-12.96 155 210 1984, 850(LS) 2.3 T5 Saloon 08.93-07.96 166 226 2319, 850(LS) 2.3 T5-R Saloon 08.95-12.96 184 250 2319, 850(LS) 2.5 Saloon 08.91-12.96 125 170 2435, 850 Estate (LW) 2.0 Estate 02.93-12.96 105 143 1984, 850 Estate (LW) 2.0 Turbo Estate 02.93-12.96 155 210 1984, 850 Estate (LW) 2.3 T5 Estate 02.93-12.96 166 226 2319, 850 Estate (LW) 2.3 T5-R Estate 08.95-12.96 184 250 2319, 850 Estate (LW) 2.5 Estate 09.92-12.96 125 170 2435, 850 Estate (LW) 2.5 AWD Estate 04.96-12.96 142 193 2435, C70 Convertible 2.0 03.98 132 180 1984, C70 Coupe 2.0 03.97-09.02 132 180 1984, C70 Coupe 2.0 T 03.97-09.02 166 226 1984, C70 Coupe 2.3 T-5 03.97-09.02 176 240 2319, C70 Coupe 2.5 T 03.97-09.02 142 193 2435, S70 2.0 Saloon 01.97-11.00 132 180 1984, S70 2.0 Saloon 01.97-11.00 105 143 1984, S70 2.0 Turbo 01.97-11.00 155 210 1984, S70 2.3 T-5 Saloon 01.97-11.00 176 239 2319, S70 2.3 Turbo Saloon 01.97-11.00 184 250 2319, S70 2.4 Turbo Saloon 01.97-11.00 142 193 2435, S70 2.5 Saloon 06.98-11.00 121 165 2435, V70 I Estate 2.0 01.97-03.00 132 180 1984, V70 I Estate 2.0 01.97-03.00 105 143 1984, V70 I Estate 2.0 Turbo 01.97-03.00 166 226 1984, V70 I Estate 2.0 Turbo 01.97-03.00 155 211 1984, V70 I Estate 2.0 Turbo AWD 01.97-03.00 166 226 1984, V70 I Estate 2.3 T AWD 04.97-03.00 184 250 2319, V70 I Estate 2.3 T-5 01.97-03.00 176 239 2319, V70 I Estate 2.3 T-5 AWD 01.97-03.00 176 239 2319, V70 I Estate 2.3 Turbo 01.97-03.00 184 250 2319, V70 I Estate 2.4 Turbo 01.97-03.00 142 193 2435, V70 I Estate 2.5 06.98-03.00 121 165 2435, V70 I Estate Turbo AWD 01.97-05.00 142 193 2435

GH5113

REPLACES / REEMPLAZA:

SIEMENS: 5WK9631; **CITROËN:** 1920.EK, 9642212180; **FORD:** 1148059, 1348614, 2S6Q12B579AA, 2S6Q12B579AB; **PEUGEOT:** 1920.EK

APPLICATION / APLICACIÓN:

CITROËN: C2 1.4 HDI Hatchback 09.03 50 68 1398, C3 1.4 HDI Hatchback 02.02 50 68 1398, C3 Pluriel 1.4 HDI Convertible 04.04 50 68 1398, XSARA (N1) 1.4 HDI Hatchback 01.03-03.05 50 68 1398, XSARA Break(N2) 1.4 HDI 01.03-08.05 50 68 1398, XSARA Coupe(NO) 1.4 HDI 01.03-03.05 50 68 1398;

FORD: FIESTA V (JH_JD_) 1.4 TDCI 11.01 50 68 1398, FUSION (JU_) 1.4 TDCI 08.02 50 68 1398;

PEUGEOT: 1007 1.4 HDI 04.05 50 68 1398, 206 Hatchback(2A/C) 1.4 HDI Eco 70 09.01 50 68 1398, 206 SW (2E/K) 1.4 HDI Estate 07.02 50 68 1398, 307 (3A/C) 1.4 HDI Hatchback 10.01 50 68 1398, 307 Break (3E) 1.4 HDI Estate 03.02 50 68 1398

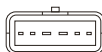

GH5114

REPLACES / REEMPLAZA:

SIEMENS: 5WK9604; **VOLVO:** 30 611 231; **HELLA :** 8ET 009 142-011

APPLICATION / APLICACIÓN:

VOLVO: S40 I (VS) 1.9 T4 Saloon 05.97-07.00 147 200 1855, S40 I (VS) 2.0 T Saloon 10.97-07.00 118 160 1948, V40 Estate (VW) 1.9 T4 05.97-07.00 147 200 1855, V40 Estate (VW) 2.0 T 10.97-07.00 118 160 1948



GH5115

REPLACES / REEMPLAZA:

SIEMENS: 5WK9615; **HELLA:** 8ET 009 142-041; **RENAULT:** 77 00 105 010

APPLICATION / APLICACIÓN:

RENAULT: LAGUNA(B56_556_) 1.9 dTi(B56J) Hatchback 10.97-03.01 72 98 1870, LAGUNA Grandtour(K56_) 1.9dTi (K56J) Estate 10.97-03.01 72 98 1870, MEGANE Classic (LA0/1_) 1.9dTi (LA08,LA0N) Saloon 03.97-02.01 72 98 1870, MEGANE Coach(DA/01_) 1.9 dTi (DA0N) Coupe 03.97-02.01 72 98 1870, MEGANE I (BA0/1_) 1.9 dTi,(BA08,BA0N) Hatchback 03.97-02.01 72 98 1870, MEGANE Scenic(JA0/1_) 1.9 dTi (JA0N) MPV 04.97-09.99 72 98 1870



GH5116

REPLACES / REEMPLAZA:

SIEMENS: 5WK9600, 5WK9617; **HELLA:** 8ET 009 142-061; **BMW:** 1703275, 1703650, 13 62 1 703 275, 13 62 1 703 650

APPLICATION / APLICACIÓN:

BMW: 3 (E36) 328 I 2.5 Saloon 03.95-02.98 125 170 2494, 3 (E36) 328 I Saloon 01.95-02.98 142 193 2793, 3 Compact(E36) 323 ti Hatchback 08.97-08.00 125 170 2494, 3 Convertible(E36) 323 I 2.5 06.95-04.99 125 170 2494, 3 Convertible(E36) 328 I 03.95-04.99 142 193 2793, 3 Coupe (E36) 323 I 2.5 03.95-04.99 125 170 2494, 3 Coupe (E36) 328 I 01.95-04.99 142 193 2793, 3 Touring (E36) 323 I 2.5 Estate 09.95-10.99 125 170 2494, 3 Touring (E36) 328 I Estate 01.95-10.99 142 193 2793, 5 (E39) 523 I Saloon 11.95-09.00 125 170 2494, 5 (E39) 528 I Saloon 11.95-09.00 142 193 2793, 5 Touring (E39) 523 I Estate 01.97-09.00 125 170 2494, 5 Touring (E39) 528 I Estate 01.97-09.00 142 193 2793, 7 (E38) 728 I,li Saloon 08.95-11.01 142 193 2793





GH5117

REPLACES / REEMPLAZA:

BOSCH: 0 280 217 503; **ALFA ROMEO:** 60589472; **FIAT:** 60589472; **HOLDEN:** 90 510 156; **IVECO:** 8024221, 98439687; **LANCIA:** 60589472; **OPEL:** 90 411 537, 90 510 156; **SCANIA:** 4239034

APPLICATION / APLICACIÓN:

ALFA: 164(164) 3.0 24V Q4(164,K1M,164,K1C) Saloon 02.94-09.98 170 231 2959, 164(164) 3.0 24V QV (164,H1) Saloon 09.92-09.98 171 233 2959;
OPEL: CALBRA A(85_) 2.5 I V6 Coupe 04.93-07.97 125 170 2498, OMEGA B(25_26_27_) 2.5 V6 Saloon 03.94-09.00 125 170 2498, OMEGA B(25_26_27_) 3.0 V6 Saloon 04.94-02.01 155 211 2962, OMEGA B Estate(21_22_23_) 2.5 V6 03.94-09.00 125 170 2498, OMEGA B Estate(21_22_23_) 3.0 V6 04.94-02.01 155 211 2962, SINTRA 3.0 I 24V MPV 11.96-04.99 148 201 2962, VECTRA B(36_) 2.5 I V6 Saloon 10.95-09.00 125 170 2498, VECTRA B(36_) I 500 2.5 Saloon 05.98-09.00 143 194 2498, VECTRA B Estate(31_) 2.5 I V6 11.96-09.00 125 170 2498, VECTRA B Estate(31_) I 500 2.5 05.98-09.00 143 194 2498, VECTRA B Hatchback(38_) 2.5 V6 10.95-09.00 125 170 2498;
SAAB: 900 II 2.5 -24 V6 Hatchback 07.93-02.98 125 170 2498, 900 II Convertible 2.5 24 V6 12.9-02.98 125 170 2498;
VAUXH: CALIBRA 2.5 I V6 Coupe 04.93-07.97 125 170 2498, OMEGA 2.5 V6 Saloon 03.94-09.00 125 170 2498, OMEGA 3.0 V6 Saloon 04.94 155 211 2962, OMEGA Estate 2.5 V6 03.94-09.00 125 170 2498, OMEGA Estate 3.0 V6 04.94 155 211 2962, SINTRA 3.0 I 24V MPV 11.96-04.99 148 201 2962, VECTRA 2.5 I Gsi Saloon 05.98-09.99 143 194 2498, VECTRA 2.5 I V6 Saloon 10.95-09.00 125 170 2498, VECTRA Estate 2.5 I Gsi 05.98-09.99 143 194 2498, VECTRA Estate 2.5 I V6 11.96-09.00 125 170 2498, VECTRA Hatchback 2.5 I Gsi 05.98-09.99 143 194 2498, VECTRA Hatchback 2.5 I V6 10.95-09.00 125 170 2498



GH5118

REPLACES / REEMPLAZA:

VW: 078 133 471 E; **HELLA:** 8ET 009 142-241; **HITACHI:** AFH 70-08D

APPLICATION / APLICACIÓN:

AUDI: A4 (8D2,B5) 2.4 Saloon 03.97-11.00 121 165 2393, A4 (8D2,B5) 2.4 Saloon 08.97-11.00 120 163 2393, A4 (8D2,B5) 2.4 Quattro Saloon 08.97-11.00 120 163 2393, A4 (8D2,B5) 2.4 Quattro Saloon 03.97-11.00 121 165 2393, A4 (8D2,B5) 2.8 Saloon 10.96-11.00 142 193 2771, A4 (8D2,B5) 2.4 Saloon 10.96-11.00 142 193 2771, A4 (8E2,B6) 2.4 Saloon 09.01-12.04 125 170 2393, A4 Avant(8D5,B5) 2.4 Estate 03.97-09.01 121 165 2393, A4 Avant(8D5,B5) 2.4 Estate 08.97-09.01 120 163 2393, A4 Avant(8D5,B5) 2.4 Quattro Estate 03.97-09.01 121 165 2393, A4 Avant(8D5,B5) 2.4 Quattro Estate 08.97-09.01 120 163 2393, A4 Avant(8D5,B5) 2.8 Estate 10.96-09.01 142 193 2771, A4 Avant(8D5,B5) 2.8 Quattro Estate 10.96-09.01 142 193 2771, A4 Avant(8E5,B6) 2.4 Estate 09.01-12.04 125 170 2393, A4 Convertible(8H7,8HE)2.4 04.02 125 170 2393, A6 (4B,C5) 2.4 Saloon 08.01-01.05 125 170 2393, A6 (4B,C5) 2.4 Saloon 07.98-01.05 100 136 2393, A6 (4B,C5) 2.4 Saloon 02.97-01.05 121 165 2393, A6 (4B,C5) 2.4 Saloon 02.97-01.05 120 163 2393, A6 (4B,C5) 2.4 Quattro 08.01-01.05 125 170 2393, A6 (4B,C5) 2.4 Quattro 02.97-01.05 121 165 2393, A6 (4B,C5) 2.4 Quattro 02.97-01.05 120 168 2393, A6 (4B,C5) 2.8 Saloon 07.99-01.05 140 190 2771, A6 (4B,C5) 2.8 Saloon 02.97-01.05 142 193 2771, A6 (4B,C5) 2.8 Quattro 02.97-01.05 142 193 2771, A6 Avant(4B,C5) 2.4 Estate 08.01-01.05 125 170 2393, A6 Avant(4B,C5) 2.4 Estate 07.98-01.05 100 136 2393, A6 Avant(4B,C5) 2.4 Estate 12.97-01.05 121 165 2393, A6 Avant(4B,C5) 2.4 Estate 12.97-01.05 120 163 2393, A6 Avant(4B,C5) 2.4 Quattro Estate 12.97-01.05 121 165 2393, A6 Avant(4B,C5) 2.4 Quattro Estate 12.97-01.05 120 163 2393, A6 Avant(4B,C5) 2.4 Quattro Estate 08.01-01.05 125 170 2393, A6 Avant(4B,C5) 2.8 Estate 07.99-01.05 140 190 2771, A6 Avant(4B,C5) 2.8 Estate 12.97-01.05 142 193 2771, A6 Avant(4B,C5) 2.8 Quattro Estate 12.97-01.05 142 193 2771, A8 (4D2,4D8) 2.8 Saloon 04.96-09.02 142 193 2771, A8 (4D2,4D8) 2.8 Quattro Saloon 04.96-09.02 142 193 2771;
SKODA: SUPERB(3U4) 2.8 V6 Saloon 02.02 142 193 2771;
VW: PASSAT (3B2) 2.8 V6 Saloon 08.96-11.00 142 193 2771, PASSAT (3B2) 2.8 V6 Syncro/4motion 10.96-11.00 142 193 2771, PASSAT (3B3) 2.8 4motion Saloon 11.00-05.05 142 193 2771, PASSAT Variant(3B5) 2.8 V6 Estate 06.97-11.00 142 193 2771, PASSAT Variant(3B5) 2.8 V6 Syncro/4motion Estate 06.97-11.00 142 193 2771, PASSAT Variant(3B6) 2.8 4 motion Estate 11.00-05.05 142 193 2771



GH5119

REPLACES / REEMPLAZA:

BOSCH: 0 280 218 065; **VW:** 06A 906 461 M

APPLICATION / APLICACIÓN:

AUDI: A3 (8L1) S3 Quattro Hatchback 10.01 165 224 1781, A3 (8L1) S3 Quattro Hatchback 03.99 154 210 1781, A6 (4B,C5) RS6 Saloon 07.02-01.05 331 450 4172, A6 Avant (4B,C5) RS6 Estate 07.02-01.05 331 450 4172, A6 Avant (4B,C5) RS6 Plus Estate 04.04-01.05 353 480 4172, TT(8N3) 1.8 T Quattro Coupe 10.98 165 224 1781, TT Roadstar (8N9) 1.8 T Quattro Convertible 10.99 165 224 1781;
SEAT: LEON (1M1) 1.8 T Cupra R 07.03 165 225 1781, LEON (1M1) 1.8 T Cupra R 02.02 154 209 1781



GH5120

REPLACES / REEMPLAZA:

SIEMENS: 5WK9638; **MERCEDES:** 271 094 0248, A271 094 0248; **HELLA:** 8ET 009 142 -351

APPLICATION / APLICACIÓN:

MERCEDES: C-CLASS(W203) C180 Kompressor(203.046) Saloon 05.02 105 143 1796, C-CLASS(W203) C200 CGI Kompressor(203.043) Saloon 07.03 125 170 1796, C-CLASS(W203) C200 Kompressor(203.042) Saloon 05.02 120 163 1796, C-CLASS(W203) C230 Kompressor(203.040) Saloon 02.04 141 192 1796, C-CLASS Coupe (CL203) C180 Kompressor(203.746) 05.02 105 143 1796, C-CLASS Coupe (CL203) C200 CGI Kompressor(203.743) 07.03 125 170 1796, C-CLASS Coupe (CL203) C200 Kompressor(203.742) 05.02 120 163 1796, C-CLASS Coupe (CL203) C 230 Kompressor(203.740) 05.02 141 192 1796, C-CLASS T-model(S203) C180 kompressor(203.246) 05.02 105 143 1796, C-CLASS T-model(S203) C200 CGI kompressor(203.243) 07.03 125 170 1796, C-CLASS T-model(S203) C200 Kompressor(203.242) 05.02 120 163 1796, C-CLASS T-model(S203) C230 Kompressor(203.240) 02.04 141 192 1796, CLK (C209) 200 CGI (209.343) Coupe 07.03 125 170 1796, CLK(C209) 200 Kompressor(209.342) 09.02 120 163 1796, CLK Convertible(A209) 200 Kompressor(209.442) 02.03 120 163 1796, E-CLASS (W211) E200 Kompressor(211.042) Saloon 11.02 120 163 1796, E-CLASS T-Model(S211) E200 T Kompressor(211.242) 03.03 120 163 1796, SLK (R171) 200 Kompressor(171.442) Convertible 03.04 120 163 1796



GH5121

REPLACES / REEMPLAZA:

BOSCH: 0 281 002 479; **OPEL:** 24 437 503, 93 173 727, 08 36 630; **SCANIA:** 24 437 503

APPLICATION / APLICACIÓN:

OPEL: VECTRA C 2.2 DTI 16V Saloon 04.02 92 125 2172, VECTRA C Estate 2.0 DTI 16V 10.03 74 100 1995, VECTRA C Estate 2.2 DTI 16V 10.03 92 125 2172, VECTRA C GTS 2.0DTI 16V Hatchback 08.02 74 101 1995, VECTRA C GTS 2.2 DTI 16V 08.02 92 125 2172;

VAUXH: SIGNUM 2.0 DTI Hatchback 05.03 74 100 1994, SIGNUM 2.2 DTI Hatchback 05.03 92 125 2188, VECTRA Mk II 1.9 CDT I 10.05 74 100 1910, VECTRA Mk II 1.9 CDT I 04.04 88 120 1910, VECTRA Mk II 1.9 CDT I 16V 04.04 110 150 1910, VECTRA Mk II 2.0 CDT I 16V 04.02 74 101 1995, VECTRA Mk II 2.2 CDT I 16V 04.02 92 125 2172, VECTRA Mk II Estate 1.9 CDT I 04.04 88 120 1910, VECTRA Mk II Estate 1.9 CDT I 10.05 74 100 1910, VECTRA Mk II Estate 1.9 CDT I 16v 04.04 110 150 1910, VECTRA Mk II Estate 2.0 CDT I 16v 10.03 74 101 1995, VECTRA Mk II Estate 2.2 CDT I 16v 10.03 92 125 2172, VECTRA Mk II GTS 1.9 CDT I 04.04 88 120 1910, VECTRA Mk II GTS 1.9 CDT I 10.05 74 100 1910, VECTRA Mk II GTS 1.9 CDT I 16V 04.04 110 150 1910, VECTRA Mk II GTS 2.0 CDT I 16V 08.02 74 101 1995, VECTRA Mk II GTS 2.2 CDT I 16V 08.02 92 125 2172



GH5122

REPLACES / REEMPLAZA:

PIERBURG: 7.22184.20.0; **FORD:** 1 051 277, 1 054 419, 1 054 420, 98 AB12B579 B1B, 98 AB12B579 B2B, 98 AB12B579 B3B

APPLICATION / APLICACIÓN:

FORD: COUGAR(EC_) 2.0 16V Coupe 08.98-12.01 96 131 1998, FOCUS (DAW,DBW) 1.8 16V Hatchback 10.98-11.04 85 115 1796, FOCUS (DAW,DBW) 1.8 TDCi Hatchback 09.02-11.04 74 100 1753, FOCUS (DAW,DBW) 1.8 TDCi Hatchback 03.01-11.04 85 115 1753, FOCUS (DAW,DBW) 2.0 16V Hatchback 10.98-11.04 96 131 1988, FOCUS C-MAX 1.8 MPV 10.03-03.07 88 120 1798, FOCUS Estate(DNW) 1.8 16V 02.99-11.04 85 115 1796, FOCUS Estate(DNW) 1.8 TDCi 03.01-11.04 85 115 1753, FOCUS Estate(DNW) 1.8 TDCi 09.02-11.04 74 100 1753, FOCUS Estate(DNW) 2.0 16V 02.99-11.04 96 131 1988, FOCUS Saloon(DFW) 1.9 16V 02.99-11.04 85 115 1796, FOCUS Saloon(DFW) 1.8 TDCi 03.01-11.04 85 115 1753, FOCUS Saloon(DFW) 2.0 16V 02.99-11.04 96 131 1988, MONDEO II (BAP) 1.6 I Hatchback 09.96-11.00 66 90 1597, MONDEO II (BAP) 1.6 I 16V Hatchback 05.98-11.00 70 95 1597, MONDEO II (BAP) 1.8 I Hatchback 09.96-11.00 85 115 1796, MONDEO II (BAP) 2.0 I Hatchback 09.96-11.00 96 131 1988, MONDEO II Estate(BNP) 1.6 I 09.96-11.00 66 90 1597, MONDEO II Estate(BNP) 1.6 I 16V 05.98-11.00 70 95 1597, MONDEO II Estate (BNP) 1.8 I 09.96-11.00 85 115 1796, MONDEO II Estate (BNP) 2.0 I 09.96-11.00 96 131 1988, MONDEO II Saloon (BFP) 1.6 I 09.96-11.00 66 90 1597, MONDEO II Saloon (BFP) 1.6 I 16V 05.98-11.00 70 95 1597, MONDEO II Saloon (BFP) 1.8 I 09.96-11.00 85 115 1796, MONDEO II Saloon (BFP) 2.0 I 09.96-11.00 96 131 1988, MONDEO III (B5Y) 1.8 16V Hatchback 11.00 81 110 1798, MONDEO III (B5Y) 1.8 16V Hatchback 11.00 107 146 1999, MONDEO III Estate(BWY) 1.8 16V 11.00 92 125 1798, MONDEO III Estate(BWY) 1.8 16V 11.00 81 110 1798, MONDEO III Estate(BWY) 2.0 16V 11.00 107 146 1999, MONDEO III Saloon(B4Y) 1.8 16V 11.00 81 110 1798, MONDEO III Saloon (B4Y) 1.8 16V 11.00 92 125 1798, MONDEO III Saloon(B4Y) 2.0 16V 11.00 107 146 1999

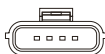

GH5123

REPLACES / REEMPLAZA:

HELLA: 8ET 009 142-161; **FORD:** 1004581, 96FB12B579EB

APPLICATION / APLICACIÓN:

FORD: ESCORT VII(GAL,AAL,ABL) 1.3 Hatchback 01.95-10.98 44 60 1299, ESCORT VII Estate (GAL,ANL) 1.3 01.95-10.98 44 60 1299, ESCORT VII Saloon (GAL,AFL) 1.3 Saloon 01.95-02.99 44 60 1299, FIESTA Box(F3L,F5L) 1.3 09.91-02.96 44 60 1299, FIESTA Box(J5_J3_) 1.3 02.96 44 60 1299, FIESTA III (GFJ) 1.1 Hatchback 03.89-12.95 37 50 1119, FIESTA III (GFJ) 1.1 Hatchback 03.89-12.95 40 55 1119, FIESTA III (GFJ) 1.3 CAT Hatchback 05.91-12.95 44 60 1299, FIESTA IV (JA_JB_) 1.25 I 16V Hatchback 08.95-01.02 55 75 1242, FIESTA IV (JA_JB_) 1.3 I Hatchback 08.95-01.02 37 50 1299, FIESTA IV (JA_JB_) 1.3 I Hatchback 08.95-01.02 44 60 1299

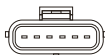

GH5124

REPLACES / REEMPLAZA:

PIERBURG: 722184050; **FORD:** 98AB12B579DA, 1072308

APPLICATION / APLICACIÓN:

FORD: FOCUS (DAW,DBW) 1.4 16V 10.98-11.04 55 75 1388, FOCUS (DAW,DBW) 1.6 16V 10.98-11.04 74 100 1596, FOCUS C-MAX 1.6 MPV 10.03-03.07 74 100 1596, FOCUS Estate(DNW) 1.4 16V 02.99-11.04 55 75 1388, FOCUS Estate(DNW) 1.6 16V 02.99-11.04 74 100 1596, FOCUS Saloon(DFW) 1.4 16V 02.99-11.04 55 75 1388, FOCUS Saloon(DFW) 1.6 16V 02.99-11.04 74 100 1596, FUSION (JU_)1.4 08.02 59 80 1388, FUSION (JU_)1.6 08.02 74 100 1596, PUMA(EC_)1.4 16V 11.97-10.00 66 90 1388



GH5125

REPLACES / REEMPLAZA:

BOSCH: 0 280 217 002; **VOLVO:** 1356220

APPLICATION / APLICACIÓN:

VOLVO



GH5126

REPLACES / REEMPLAZA:

VW: 058 133 471/058 133 471E; **HITACHI:** AFH8010B

APPLICATION / APLICACIÓN:

AUDI: A3(8L1) 1.6 Hatchback 09.96-08.00 74 101 1595, A3(8L1) 1.8 Hatchback 09.96 92 125 1781, A4(8D2,B5) 1.6 Saloon 01.95-07.00 74 100 1595, A4(8D2,B5) 1.8 Saloon 01.95-11.00 92 125 1781, A4(8D2,B5) 1.8 Quattro 01.95-11.00 92 125 1781, A4 Avant(8D5,B5) 1.6 Estate 03.96-07.00 74 100 1595, A4 Avant(8D5,B5) 1.8 Estate 02.96-09.01 92 125 1781, A4 Avant(8D5,B5) 1.8 quattro 01.96-09.01 92 125 1781, A6 (4B,C5) 1.8 Saloon 07.97-01.05 92 125 1781, A6 Avant(4B,C5) 1.8 Estate 12.97-01.05 92 125 1781, CABRIOLET(8G7,B4) 1.8 Convertible 01.97-08.00 92 125 1781;

VW: PASSAT (3B2) 1.6 Saloon 10.96-11.00 74 101 1595, PASSAT (3B2) 1.8 Saloon 10.96-11.00 92 125 1781, PASSAT Variant 1.8 Syncro/4motion 10.96-11.00 92 125 1781, PASSAT Variant (3B5) 1.6 Estate 06.97-11.00 74 101 1595, PASSAT Variant (3B5) 1.8 Estate 06.97-11.00 92 125 1781, PASSAT Variant (3B5) 1.8 Syncro /4motion Estate 06.97-11.00 92 125 1781

GH5127

REPLACES / REEMPLAZA:

BOSCH: 0 281 002 549; **FIAT:** 55187718; **OPEL:** 24 439 252/08 36 635

APPLICATION / APLICACIÓN:

OPEL: ASTRA G HATCHBACK(F48_F08_)1.7 CDTI 04.03-01.05 59 80 1686, ASTRA G SALOON(F69_)1.7 CDTI 04.03-01.05 59 80 1686, COMBO BOX BODY/ESTATE 1.3 CDTI 16V 08.05 51 69 1248, COMBO BOX BODY/ESTATE 1.3 CDTI 16V 10.05 55 75 1248, COMBO BOX BODY/ESTATE 1.7 CDTI 16V 12.04 74 101 1686, COMBO TOUR 1.3 CDTI 16V 10.05 55 75 1248, COMBO TOUR 1.3 CDTI 16V 10.04 51 69 1248, COMBO TOUR 1.7 CDTI 16V 12.04 74 101 1686, CORSA C (F08,F68)1.3 CDTI 06.03 51 70 1248, CORSA C (F08,F68)1.7 CDTI 06.03 74 100 1686, CORSA C BOX (F08,W5L)1.3 CDTI 16V 08.05 51 69 1248, TIGRA TWINTOP 1.3 CDTI 06.04 51 69 1248;

VAUXH: ASTRA MK IV 1.7 CDTI 16V 04.03 59 80 1686, ASTRA MK IV ESTATE 1.7 CDTI 16V 04.03 59 80 1686, ASTRA MK IV HATCHBACK 1.7 CDTI 16V 04.03 59 80 1686, ASTRAVAN MK IV 1.7 CDTI 04.04 59 80 1686, CORSA MK II 1.3 CDTI 16V 04.04 52 70 1248, CORSA MK II 1.7 CDTI 16V 04.04 74 100 1686, CORSAVAN MK 11 1.3 CDTI 16V 04.04 52 70 1248



GH5128

REPLACES / REEMPLAZA:

BOSCH: 0 280 218 119; **OPEL:** 24420614 /93179927 /08 36 644

APPLICATION / APLICACIÓN:

OPEL: AGILA(H00)1.0 08.03 44 60 998, AGILA(H00)1.2 16V TWINPORT 07.04 59 80 1229, ASTRA H 1.4 03.04 66 90 1364, ASTRA H ESTATE 1.4 08.04 66 90 1364, ASTRA H GTC 1.4 03.05 66 90 1364, COMBO BOX BODY/ESTATE 1.4 16V 08.05 66 90 1364, COMBO TOUR 1.4 10.04 66 90 1364, CORSA C (F08,F68)1.0 06.03 44 60 998, CORSA C (F08,F68)1.2 TWINPORT 07.04 59 80 1229, CORSA C (F08,F68)1.4 TWINPORT 06.03 66 90 1364, CORSA BOX (F08,W5L)1.2 07.05 59 80 1229, MERIVA 1.4 16V TWINPORT 07.04 66 90 1364, TIGRA TWINTOP 1.4 06.04 66 90 1364;

VAUXH: ASTRA MK V ESTATE 1.4 08.04 66 90 1364, ASTRA MK V HATCHBACK 1.4 03.04 66 90 1364, COMBO 1.4 01.04 66 90 1364



GH5129

REPLACES / REEMPLAZA:

BOSCH: 0 280 218 075; **BMW:** 1362 1438 687, 1362 7 566 986

APPLICATION / APLICACIÓN:

BMW: 1 (E81,E87) 116i 09.07 90 122 1597, 1 (E81,E87) 116i 09.04 85 115 1596, 3 (E46) 316i 02.02-02.05 85 115 1796, 3 (E46) 316i 06.02-02.05 85 115 1596, 3 (E46) 318i 09.01-02.05 105 143 1995, 3 Compact (E46) 316 ti 06.01-02.05 85 115 1796, 3 Compact (E46) 318 ti 09.01-02.05 105 143 1995, 3 Touring (E46) 316 ti 03.02-02.05 85 115 1796, 3 Touring (E46) 318 ti 09.01-02.05 105 143 1995, 3 (E46) 318 Ci 02.05 110 150 1995, 3 (E46) 318 Ci 09.01 105 143 1995, 3 (E46) 316Ci 06.02 85 115 1596, 3 (E46) 318Ci 03.05 110 150 1995, 3 (E46) 318Ci 09.01 105 143 1995

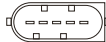

GH5130

REPLACES / REEMPLAZA:

BOSCH: 0 280 217 509; **MERCEDES:** 000 094 0848

APPLICATION / APLICACIÓN:

MERCEDES: S-CLASS (W140) 600 SE,SEL (140.056.140.057) 04.91-12.92 300 408 5987, S-CLASS (W140) S 600 (140.056.140.057) 01.93-10.98 290 394 5987, S-CLASS (C140) SEC/CL 600 (140.076) 09.92-02.99 290 394 5987, SL (R129) 600 (129.076) 07.92-10.01 290 394 5987, E-CLASS (W210) E 290 TURBO-D (210.017) 03.96-07.99 95 129 2874, E-CLASS (S210) E 290 TURBO-D(210.217) 06.96-07.99 95 129 2874



GH5131

REPLACES / REEMPLAZA:

BOSCH: 0 280 217 512; **VW:** 021 906 462A

APPLICATION / APLICACIÓN:

FORD: GALAXY (WGR) 2.8 i V6 11.95-04.00 128 174 2792, GALAXY (WGR) 2.8 i V6 4*4 04.96-04.00 128 174 2792;

VW: GOLF III (1H1) 2.8 VR6 01.92-08.97 128 174 2792, GOLF III Variant (1H5) 2.9 VR6 Syncro 10.94-04.99 140 190 2861, SHARAN (7M8,7M9,7M6) 2.8 VR6 09.95-04.00 128 174 2792, SHARAN (7M8,7M9,7M6) 2.8 VR6 Syncro 11.96-04.00 128 174 2792, TRANSPORTER IV (70XB,70XC,7DB,7DW)2.8VR 6 11.95-04.44 103 140 2792, VENTO (1H2) 2.8 VR6 01.92-09.98 128 174 2792

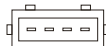



GH5133

REPLACES / REEMPLAZA:

SIEMENS: 5WK9007; **BMW:** 13 62 1730033

APPLICATION / APLICACIÓN:

BMW: 3 (E36) 320 i 09.90-02.98 110 150 1991, 3 Touring (E36) 320 i 01.95-10.99 110 150 1991, 3 (E36) 320 i 12.93-04.99 110 150 1991, 3 (E36) 320 i 03.92-04.99 110 150 1991, 5 (E34) 520 i 24V 09.89-09.95 110 150 1991, 5 (E39) 520 i 01.96-09.00 110 150 1991, 5 Touring (E34) 520 i 11.91-01.97 110 150 1991, 5 Touring (E39) 520 i 01.97-09.00 110 150 1991



GH5135

REPLACES / REEMPLAZA:

BOSCH: 0 280 218 051; **LOTUS:** A116E6059F; **OPEL:** 08 36 588,90 423 761, 92 01 425, 92 04 425

APPLICATION / APLICACIÓN:

OPEL: ASTRA G 2.0 16V TURBO 11.02-10.05 147 200 1998, ASTRA G 2.0 OPC 03.02-10.05 141 192 1998, ASTRA G (F35_)2.0 OPC 11.02-07.04 147 200 1998, ASTRA G (F35_)2.0 OPC 09.02-07.04 141 192 1998, ASTRA G (F48_F08_)2.0 OPC 11.02-01.05 147 200 1998, ASTRA G (F48_F08_)2.0 OPC 09.02-01.05 141 192 1998, ASTRA G (F07_)2.0 16V TURBO 08.01-05.05 141 192 1998, ASTRA G (F07_)2.0 16V TURBO 09.00-08.01 140 190 1998, ASTRA G (F07_)2.0 16V TURBO 11.02-05.05 147 200 1998, SPEEDSTER 2.0 TURBO 04.03. 147 200 1998, ZAFIRA(F75_)2.0 OPC 11.02-06.05 147 200 1998, ZAFIRA(F75_)2.0 OPC 09.01-06.05 141 192 1998;

VAUXH: ASTRA MK IV 2.0 TURBO 03.02. 141 192 1998, ASTRA MK IV 2.0 SRI TURBO 07.02. 141 192 1998, ASTRA MK IV 2.0 16V TURBO 09.00. 140 190 1998, VX 220 2.0 I TURBO 04.03. 147 200 1998, ZAFIRA 2.0 GSI TURBO 09.01. 141 192 1998



GH5136

REPLACES / REEMPLAZA:

BOSCH: 0 280 217 502; **BMW:** 13 62 1 733 258, 13 62 1 738 908, 13 62 1 747 155

APPLICATION / APLICACIÓN:

BMW: 3 (E36)325 i 09.90-09.95 141 192 2494, 3 (E36)325 i 03.93-03.95 141 192 2494, 3 (E36)325 i 03.92-04.99 141 192 2494, 5 (E34)525 i 24V 09.89-09.95 141 192 2494, 5 (E34)525 i X 24V 10.91-09.95 141 192 2494, 5 (E34)530 i V8 09.92-09.95 160 218 2997, 5 (E39)535 i 04.96-03.99 173 235 3498, 5 TOURING(E34) 525 i 11.91-01.97 141 192 2494, 5 TOURING(E34) 525 i X 02.92-01.97 141 192 2494, 5 TOURING(E34) 530 i V8 09.92-01.97 160 218 2997, 7 (E32) 730 i,IL V8 04.92-09.94 160 218 2997, 7 (E38) 730 i,IL 10.94-11.01 160 218 2997, 7 (E38) 730 i,IL 10.94-11.01 155 211 2997, 7 (E38) 735 i,IL 01.96-11.01 173 235 3498



GH5137

REPLACES / REEMPLAZA:

BOSCH: 0 280 218 154; **NISSAN:** 22680 8J000

APPLICATION / APLICACIÓN:

NISSAN: Sentra 2.5L 2001-2003, Altima 2.5L 2001-2003, Altima 3.5L 2001-2003

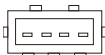

GH5138

REPLACES / REEMPLAZA:

BOSCH: 0 986 JG0 309; **NISSAN:** 22680 30P00

APPLICATION / APLICACIÓN:

NISSAN: 300ZX 3.0L 02/89>09/93



GH5139

REPLACES / REEMPLAZA:

BOSCH: 0 281 002 207; **NISSAN:** 22680 7F400, 22680 7F425

APPLICATION / APLICACIÓN:

NISSAN: PRIMERA(P11)2.0 TD 09.96-12.01 66 90 1974, PRIMERA HATCHBACK(P11)2.0 TD 09.96-07.02 66 90 1974, PRIMERA TRAVELLER(WP11)2.0 TD 04.98-12.01 66 90 1974, TERRANO II(R20)2.7 Tdi 4WD 05.96 92 125 2664

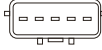

GH5140

REPLACES / REEMPLAZA:

BOSCH: 0 280 218 005, 0 986 280 232; **NISSAN:** 22680 36550, 22680 7J600

APPLICATION / APLICACIÓN:

NISSAN: ALMERA II(N16)2.2 DI 07.00 81 110 2184, ALMERA II HATCHBACK(N16)1.5 03.00 66 90 1498, ALMERA II HATCHBACK(N16)1.8 03.00 84 114 1769, ALMERA II HATCHBACK(N16)2.2 DI 03.00 81 110 2184, ALMERA TINO(V10)1.8 08.00 84 114 1769, ALMERA TINO(V10)2.2 DI 08.00 84 115 2184, PRIMERA(P11)1.8 16V 08.99-12.01 84 114 1769, PRIMERA(P12)2.2 DI 03.02 93 126 2184, PRIMERA HATCHBACK(P11)1.8 16V 08.99-07.02 84 114 1769, PRIMERA HATCHBACK(P12)2.2 DI 07.02 93 126 2184, PRIMERA TRAVELLER(WP11)1.8 16V 08.99-12.01 84 114 1769, PRIMERA(WP12)2.2DI 03.02 93 126 2184



GH5141

REPLACES / REEMPLAZA:

BOSCH: 0 280 218 120; **FIAT:** 46811122

APPLICATION / APLICACIÓN:

ALFA: 147 (937)1.9 JTD 06.03 74 101 1910, 147 (937)1.9 JTD(937AXD1A) 04.01 85 115 1910, 147 (937)1.9 JTD 16V 11.02 103 140 1910, 147 (937)1.9 JTD 16V 10.04 100 136 1910, 147 (937)1.9 JTD 16V 09.03-09.04 93 126 1910, GT 1.9 JTD 11.03 110 150 1910, GT 2.0 JTS 11.03 121 165 1970;

FIAT: MULTIPLA (186)1.9 JTD 115 07.02 85 115 1910, STILO(192) 1.9 JTD 01.04 103 140 1910, STILO MULTI WAGON(192)1.9 JTD 01.04 103 140 1910



GH5142

REPLACES / REEMPLAZA:

BOSCH: 0 281 002 199; **FIAT:** 46447508, 46472182; **ALFA ROMEO:** 46 472 182, 46 447 508

APPLICATION / APLICACIÓN:

ALFA: 156(932)2.4 JTD(932B1) 09.97-10.00 100 136 2387, 156(932)1.9 JTD(932B2) 09.97-10.00 77 105 1910, GTV(916C_)1.8 16V(916C3) 05.98 106 144 1747

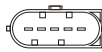

GH5143

REPLACES / REEMPLAZA:

VDO: 5WK9624; **HELLA:** 8ET 009 142-151; **VOLVO:** 30 611 533

APPLICATION / APLICACIÓN:

VOLVO: S40 (VS)2.0 07.95-12.03 100 136 1948, V40 (VW)2.0 07.95-06.04 100 136 1948, S40 I(VS)1.8 03.99-12.03 90 122 1783, S40 I(VS)1.6 03.99-12.03 80 109 1587, V40 (VW)1.8 03.99-06.04 90 122 1783, V40 (VW)1.6 03.99-06.04 80 109 1587



GH5144

REPLACES / REEMPLAZA:

VDO: 5WK96133, **HELLA:** 8ET 009 142-381; **VOLVO:** 3 061 153 2

APPLICATION / APLICACIÓN:

VOLVO: V40 (VW)2.0 T 07.00-06.01 121 165 1948, S40 I(VS)2.0 T 07.00-06.01 121 165 1948, S40 I(VS)2.0 T4 07.00-12.03 147 200 1948, V40(VW)2.0 T4 07.00-06.04 147 200 1948, S40 I (VS)2.0 T 06.01-12.03 120 163 1948, V40 (VW)2.0 T 06.01-06.04 120 163 1948



GH5146

REPLACES / REEMPLAZA:

BOSCH: 0 280 218 116

APPLICATION / APLICACIÓN:

LADA: KALINA(1117)1.6 10.04 60 82 1596

GH5147

REPLACES / REEMPLAZA:
HITACHI: AFH70M-40611B; **ISUZU:** 8 97601 9670
 APPLICATION / APLICACIÓN:
ISUZU: Rhodeo 1997 - Diesel



GH5149

REPLACES / REEMPLAZA:
HITACHI: AFH70-34 7H22; **FORD:** 3W7Z12B579BA; **CARDONE:** 86-50025
 APPLICATION / APLICACIÓN:
FORD: CROWN VICTORIA 2004 8 Cyl 4.6L, CROWN VICTORIA 2006 8 Cyl 4.6L



GH5150

REPLACES / REEMPLAZA:
HITACHI: AFH50M-04, B7828; **GM:** 3540523, 88961010; **CARDONE:** 86-9542
 APPLICATION / APLICACIÓN:
CADILLAC: CONCOURS 1996-1999 8 Cyl 4.6L, ELDORADO 1996-1999 8 Cyl 4.6L, SEVILLE 1996-1999 8 Cyl 4.6L



GH5151

REPLACES / REEMPLAZA:
HITACHI: AFH80-10 8D28; **FORD:** 3L7Z12B579AA; **CARDONE:** 86-9933
 APPLICATION / APLICACIÓN:
FORD: EPEDITION 2003-2004 8 Cyl 4.6L;
LINCOLN: NAVIGATOR 2003-2005 8 Cyl 5.4L



GH5152

REPLACES / REEMPLAZA:
FORD: F6DZ12B579EARM, F6DF 12B579-EA, AFLS-182RM; **CARDONE:** 86-9555
 APPLICATION / APLICACIÓN:
FORD: E-150 ECONOLINE 1999-2000 6 Cyl 4.2L, E-250 ECONOLINE 1999-2000 6 Cyl 4.2L, E-250 ECONOLINE 1997-1998 6 Cyl 4.2L, F-150 PICKUP 2002-2005 6 Cyl 4.2L, F-150 PICKUP 1997-2001 6 Cyl 4.2L, WINDSTAR 1997-1998 6 Cyl 3.8L, WINDSTAR 1996 6 Cyl 3.8L; **MERCURY:** Cougar 6 Cyl 2.5L 2000, Mystique 6 Cyl 2.5L 2000, Cougar From 5/25/99 6 Cyl 2.5L 1999, Mystique From 5/3/99 6 Cyl 2.5L 1999, Sable w/24 Valve Eng. 6 Cyl 3.0L 1999, Sable w/I.D. #F6DF 12B579-EA 3.0L 6 Cyl 3.0L 1996-1998



GH5153

REPLACES / REEMPLAZA:
FORD: F5UZ12B579AARM; **CARDONE:** 86-9519
 APPLICATION / APLICACIÓN:
FORD: BRONCO 1994-1995 8 Cyl 5.0L, BRONCO 1995 8 Cyl 5.8L, E-150 ECONOLINE 1995 8 Cyl 4.9L, E-150 ECONOLINE 1994 8 Cyl 5.0L, E-150 ECONOLINE 1993 8 Cyl 5.0L, E-150 ECONOLINE 1995 8 Cyl 5.8L, E-250 ECONOLINE 1994 6 Cyl 4.9L, E-250 ECONOLINE 1995 8 Cyl 5.8L, E-350 ECONOLINE 1995 6 Cyl 4.9L, E-350 ECONOLINE 1995 8 Cyl 5.8L, F-150 PICKUP 1995 8 Cyl 5.0L, F-150 PICKUP 1994 8 Cyl 5.0L, F-250 PICKUP 1995 6 Cyl 4.9L, F-350 PICKUP 1995 8 Cyl 5.8L





GH5154

REPLACES / REEMPLAZA:

FORD: F2VZ12B579AARM; **HITACHI:** AFH70-04 4K21; **CARDONE:** 86-9508

APPLICATION / APLICACIÓN:

FORD: CROWN VICTORIA 1992-94 8 Cyl 4.6L, MUSTANG 1994-95 6 Cyl 3.8L;

LINCOLN: TOWN CAR 1991-94 8 Cyl 4.6L;

MERCURY: GRAND MARQUIS 1992-94 8 Cyl 4.6L

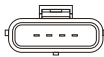

GH5155

REPLACES / REEMPLAZA:

FORD: F8LZ12B579AARM; **CARDONE:** 86-9524

APPLICATION / APLICACIÓN:

FORD: E SUPER DUTY 1996-99 8 Cyl 5.4L, E SUPER DUTY 1996-99 8 Cyl 7.5L, E-150 ECONOLIN 1997-99 8 Cyl 4.6L, E-150 ECONOLIN 1997-99 8 Cyl 5.4L, E-250 ECONOLINE 1997-99 8 Cyl 4.6L, E-250 ECONOLINE 1997-99 8 Cyl 5.4L, E-350 ECONOLIN 1997-99 8 Cyl 5.4L, E-350 ECONOLIN 1997-99 10 Cyl 6.8L, EXPEDITION 1997-98 8 Cyl 4.6L, EXPEDITION 1997-98 8 Cyl 5.4L, F-150 PICKUP 1997-98 8 Cyl 4.6L, F-150 PICKUP 1997-98 8 Cyl 5.4L, F-250 PICKUP 1996-98 8 Cyl 4.6L, F-250 PICKUP 1996-98 8 Cyl 5.4L, F-350 PICKUP 1996-97 8 Cyl 7.5L, MUSTANG 1996-98 8 Cyl 4.6L, TAURUS 1996-97 8 Cyl 3.4L;

LINCOLN: CONTINENTAL 1995-97 8 Cyl 4.6L, MARK VIII 1995-98 8 Cyl 4.6L, NAVIGATOR 1998 8 Cyl 5.4L

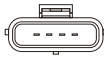

GH5156

REPLACES / REEMPLAZA:

FORD: F5RZ12B579CARM, F7RZ12B579AARM; **CARDONE:** 86-9523

APPLICATION / APLICACIÓN:

FORD: CONTOUR 1995-1999 6 Cyl 2.5L;

MERCURY: COUGAR 2001-2002 6 Cyl 2.5L, COUGAR 1999 6 Cyl 2.5L, MYSTIQUE 1999 6 Cyl 2.5L, MYSTIQUE 1995-1998 6 Cyl 2.5L



GH5157

REPLACES / REEMPLAZA:

FORD: F37Z12B579FARM, ZZM31320A 3K27; **CARDONE:** 86-9514

APPLICATION / APLICACIÓN:

FORD: ESCORT 1994-1995 4 Cyl 1.9L, RANGER 1993-1995 4 Cyl 2.3L, RANGER 1993-1995 6 Cyl 3.0L, RANGER 1992 6 Cyl 3.0L, RANGER 1991 6 Cyl 3.0L;

MAZDA: B2300 1994 4 Cyl 2.3L, B3000 1994 6 Cyl 3.0L;

MERCURY: TRACER 1995-94 4 Cyl 1.9L



GH5158

REPLACES / REEMPLAZA:

FORD: F0VZ12B579AARM; **HITACHI:** AFH45-25 4L03; **CARDONE:** 86-9505

APPLICATION / APLICACIÓN:

FORD: BRONCO II 1990 6 Cyl 2.9L, LTD CROWN VICTORIA. 1990-1991 8 Cyl 5.0L, MUSTANG 1990-1993 4 Cyl 2.3L, MUSTANG 1990 8 Cyl 5.0L, RANGER 1990-1991 6 Cyl 2.9L, TAURUS 1991 4 Cyl 2.5L, TAURUS 1989-1993 6 Cyl 3.0L, TEMPO 1992-1994 6 Cyl 3.0L;

LINCOLN: TOWN CAR 1990 8 Cyl 5.0L;

MERCURY: GRAND MARQUIS 1990-1991 8 Cyl 5.0L, SABLE 1991-1993 6 Cyl 3.0L, TOPAZ 1992-1994 6 Cyl 3.0L



GH5159

REPLACES / REEMPLAZA:

FORD: FS1513215, FS1513215ROO, AFH45-27, 3F16; **CARDONE:** 86-9511

APPLICATION / APLICACIÓN:

FORD: PROBE 1993-1995 4 Cyl 2.0L;

MAZDA: 626. 1994-1995 4 Cyl 2.0L, MX-6 1994-1995 4 Cyl 2.0L



GH5160

REPLACES / REEMPLAZA:

FORD: F4SZ12B579AARM, **CARDONE:** 86-9518

APPLICATION / APLICACIÓN:

FORD: THUNDERBIRD 1994-1995 6 Cyl 3.8L, THUNDERBIRD 1994-1995 8 Cyl 4.6L;

MERCURY: COUGAR 1994-1995 6 Cyl 3.8L, COUGAR 1994-1995 8 Cyl 4.6L



GH5161

REPLACES / REEMPLAZA:

FORD: F1ZZ12B579A, F1ZZ12B579AARM, **HITACHI:** AFH55-03B 4K26, **CARDONE:** 86-9502

APPLICATION / APLICACIÓN:

FORD: MUSTANG 1992-1993 8 Cyl 5.0L, MUSTANG 1990-1991 8 Cyl 5.0L, MUSTANG 1989 8 Cyl 5.0L, TAURUS 1994-1995 6 Cyl 3.0L, TAURUS 1989-1993 6 Cyl 3.0L, TAURUS 1993-1995 6 Cyl 3.2L, TAURUS 1991-1995 6 Cyl 3.8L, THUNDERBIRD 1991-1993 6 Cyl 3.8L, THUNDERBIRD 1991-1993 8 Cyl 5.0L;

LINCOLN: CONTINENTAL 1994-91 6 Cyl 3.8L;

MERCURY: COUGAR 1991-1993 6 Cyl 5.0L, SABLE 1991-1995 6 Cyl 3.8L



GH5163

REPLACES / REEMPLAZA:

NISSAN: 22680 7S000; **CARDONE:** 86-50036

APPLICATION / APLICACIÓN:

INFINITI: FX35 2004-2008 6 Cyl 3.5L, G35 2004-2007 6 Cyl 3.5L, M35 2006-2007 6 Cyl 3.5L, M45 2006-2007 8 Cyl 4.5L, QX56 2004-2007 8 Cyl 5.6L;

NISSAN: ARMADA 2005-2007 8 Cyl 5.6L, FRONTIER 2005-2007 4 Cyl 2.5L, PATHFINDER 2004 6 Cyl 3.5L, PATHFINDER 2005-2007 6 Cyl 4.0L, TITAN 2004-2007 8 Cyl 5.6L, VERSA 2007 4 Cyl 1.8L, XTERRA 2005-2007 6 Cyl 4.0L



GH5166

REPLACES / REEMPLAZA:

FORD: XW4Z12B579AARM; **HITACHI:** AFH70-18R 5L14; **CARDONE:** 86-9563

APPLICATION / APLICACIÓN:

FORD: CROWN VICTORIA 2000-2002 8 Cyl 4.6L, THUNDERBIRD 2003 8 Cyl 3.9L;

LINCOLN: LS 2000-2002 6 Cyl 3.0L, TOWN CAR 2000-2002 8 Cyl 4.6L;

MERCURY: GRAND MARQUIS 2000-2002 8 Cyl 4.6L



GH5168

REPLACES / REEMPLAZA:

FORD: F8DZ12B579BA, XL3Z12B579BARM, **HITACHI:** AFH80-06CR 8K20, **CARDONE:** 86-9554

APPLICATION / APLICACIÓN:

FORD: EXPEDITION 1999-2002 8 Cyl 4.6L, F-150 PICKUP 1999-2004 8 Cyl 4.6L, F-250 PICKUP 1999 8 Cyl 4.6L, F-250 SUPER DUTY 1999 8 Cyl 5.4L, F-250 SUPER DUTY 1999 8 Cyl 5.4L, F-250 SUPER DUTY 1999 8 Cyl 5.4L, F-350 SUPER DUTY 1999 8 Cyl 5.4L, F-350 SUPER DUTY 1999 10 Cyl 6.8L, F-450 SUPER DUTY 1999 10 Cyl 6.8L, F-550 SUPER DUTY 1999 10 Cyl 6.8L, TAURUS 1996-1999 8 Cyl 3.4L;

LINCOLN: BLACKWOOD 2002 8 Cyl 5.4L, NAVIGATOR 1999-2002 8 Cyl 5.4L



GH5169

REPLACES / REEMPLAZA:

FORD: 1L2Z12B579AAA; **HITACHI:** AFH80-06E 6M18; **CARDONE:** 86-9564

APPLICATION / APLICACIÓN:

FORD: EXPLORER 2002-2005 8 Cyl 4.6L;

LINCOLN: AVIATOR 2003-2005 8 Cyl 4.6L;

MERCURY: MOUNTAINEER 2003-2005 8 Cyl 4.6L

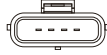

GH5170

REPLACES / REEMPLAZA:

FORD: XL3Z12B579AARM; **HITACHI:** AFH80-06B 4E26; **CARDONE:** 86-50020

APPLICATION / APLICACIÓN:

FORD: F-150 1999 V8 5.4L

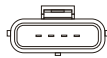

GH5171

REPLACES / REEMPLAZA:

FORD: F6SZ12B579AARM; **HITACHI:** AFH70-020 4F29; **CARDONE:** 86-9539

APPLICATION / APLICACIÓN:

FORD: THUNDERBIRD 1996-1997 6 Cyl 3.8L, THUNDERBIRD 1996-1997 8 Cyl 4.6L;

MERCURY: COUGAR 1996-1997 6 Cyl 3.8L, COUGAR 1996-1997 8 Cyl 4.6L



GH5172

REPLACES / REEMPLAZA:

FORD: F23Z12B579AARM; **HITACHI:** AFH60-01 4J23; **CARDONE:** 86-9506

APPLICATION / APLICACIÓN:

FORD: AEROSTA 1993-1995 6 Cyl 3.0L, AEROSTA 1992 6 Cyl 3.0L, RANGER 1992 6 Cyl 3.0L, RANGER 1992 6 Cyl 3.0L, TEMPO 1992-1994 4 Cyl 2.3L;

MERCURY: TOPAZ 1992-1994 4 Cyl 2.3L

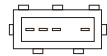

GH5173

REPLACES / REEMPLAZA:

FORD: F5RZ12B579AARM; **HITACHI:** AFH60-02A 8B21; **CARDONE:** 86-9522

APPLICATION / APLICACIÓN:

FORD: CONTOUR 1999 4 Cyl 2.0L, CONTOUR 1995-1998 4 Cyl 2.0L;

MERCURY: COUGAR 1999 4 Cyl 2.0L, MYSTIQUE 1999 4 Cyl 2.0L, MYSTIQUE 1995-1998 4 Cyl 2.0L

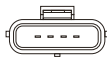

GH5174

REPLACES / REEMPLAZA:

FORD: FSC213215, FSC213215ROO; **HITACHI:** AFH45-27A 8A15; **CARDONE :** 86-9546

APPLICATION / APLICACIÓN:

FORD: PROBE 1996-1997 4 Cyl 2.0L;

MAZDA: 626 1996-1997 4 Cyl 2.0L, MX-6 1996-1997 4 Cyl 2.0L



GH5175

REPLACES / REEMPLAZA:

FORD: F07Z12B579AARM, ZL013215A; **HITACHI:** AFH55-05 4K26; **CARDONE:** 86-9504

APPLICATION / APLICACIÓN:

FORD: AEROSTAR 1990-1995 6 Cyl 3.0L, AEROSTAR 1990-1995 6 Cyl 4.0L, BRONCO 1994 8 Cyl 5.0L, E-150 ECONOLINE 1994 8 Cyl 5.0L, EXPLORER 1991-1995 6 Cyl 4.0L, F-150 PICKUP 1994 8 Cyl 5.0L, F-250 PICKUP 1994 8 Cyl 5.0L, RANGER 1993-1995 6 Cyl 3.0L, RANGER 1995 6 Cyl 4.0L, RANGER 1990-1994 6 Cyl 4.0L;

LINCOLN: TOWN CAR 1991-1992 8 Cyl 4.6L;

MAZDA: B4000 1994 6 Cyl 4.0L, NAVAJO 1991-1994 6 Cyl 4.0L;

MERCURY: GRAND MARQUIS 1992 8 Cyl 4.6L

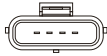

GH5176

REPLACES / REEMPLAZA:

FORD: F57Z12B579DBRM, ZZM213210,4032929,1D25-C2-2,4459836; **CARDONE:** 86-9549

APPLICATION / APLICACIÓN:

FORD: AEROSTAR 1996-1997 6 Cyl 4.0L, EXPLORER 1995-1998 6 Cyl 4.0L, MUSTANG 1996-2000 6 Cyl 3.8L, RANGER 1996-2000 6 Cyl 4.0L, RANGER 1995 6 Cyl 4.0L;

MAZDA: B4000 1995-2000 6 Cyl 4.0L;

MERCURY: MOUNTAINEER 1997-1998 6 Cyl 4.0L



GH5177

REPLACES / REEMPLAZA:

FORD: F0CZ12B579AARM, AFH38-06; **CARDONE:** 86-9503

APPLICATION / APLICACIÓN:

FORD: ESCORT 1991-1993 4 Cyl 1.9L;

MERCURY: TRACER 1991-1993 4 Cyl 1.9L



GH5178

REPLACES / REEMPLAZA:

GM: 24502966, 25535419; **HITACHI:** AFH50M-02E C3823; **CARDONE:** 86-5419

APPLICATION / APLICACIÓN:

BUICK: CENTURY 1989-1993 6 Cyl 3.8L, SKYLARK 1989-1993 6 Cyl 3.3L;

OLDSMOBILE: ACHIEVA 1992-1993 6 Cyl 3.3L, CUTLASS CALAIS 1989-1991 6 Cyl 3.3L, CUTLASS CIERA 1989-1993 6 Cyl 3.3L;

PONTIAC: GRAND AM 1992-1993 6 Cyl 3.3L

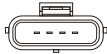

GH5181

REPLACES / REEMPLAZA:

HELLA: 8ET 009 142-281; **FORD:** 1 129 009, XS7F-12B579-AA; **HITACHI:** AFH60M-16

APPLICATION / APLICACIÓN:

FORD: MONDEO III(B5Y)2.0 16V TDDi/TDCi 11.00 85 115 1998, MONDEO III(B5Y)2.0 TDCi 10.01 96 130 1998, MONDEO III(BWY)2.0 16V TDDi/TDCi 11.00 85 115 1998, MONDEO III(BWY)2.0 TDCi 10.01 96 130 1998, MONDEO III(B4Y)2.0 16V TDDi/TDCi 11.00 85 115 1998, MONDEO III(B4Y)2.0 TDCi 10.01 96 130 1998, TRANSIT(FD_FB_FS_FZ_FC_)2.0 TDCi(F_F_F_E_F_G_) 08.02 92 125 1998, TRANSIT(FA_)2.0 TDCi 08.02 92 125 1998, TRANSIT(FM_FN_) 2.0 TDCi(F_E_F_F_) 08.02 92 125 1998



GH5182

REPLACES / REEMPLAZA:

HELLA: 8ET 009 142-111; **VDO:** 5WK97004; **CITROËN:** 1920.GG, 96.471.440.80; **FORD:** 1 333 637, 1 348 615, 2S6Q 12B579 BA, 2S6Q 12B579 BB; **PEUGEOT:** 1920.GG

APPLICATION / APLICACIÓN:

CITROËN: C1(PM_PN_)1.4 HDi 06.05 40 54 1398, C2(JM_)1.4 HDi 09.03 50 68 1398, C3(FC_)1.4 HDi 02.02 50 68 1398, C3 Pluriel(HB_) 1.4 HDi 04.04 50 68 1398, NEMO(AA_)1.4 TDi 02.08 50 68 1398;

FORD: FIESTA V(JH_JD_)1.4 TDCi 11.01 50 68 1399, FUSION(JU_)1.4 TDCi 08.02 50 68 1399;

PEUGEOT: 1007(KM_)1.4 HDi 04.05 50 68 1398, 107 1.4 HDi 06.05 40 54 1398, 206 SW(2E/K) 1.4 HDi 07.02 50 68 1398, 206 (2A/C) 1.4 HDi eco 70 09.01 50 68 1398, 207(WA_WC_)1.4 HDi 02.06 50 68 1398, BIPPER(AA_)1.4 HDi 02.08 50 68 1398



GH5183

REPLACES / REEMPLAZA:

HELLA: 8ET 009 142-421; **VDO:** 5WK97001; **CITROËN:** 96 459 487 80, 1920.GN; **PEUGEOT:** 96 459 487 80, 1920.GN

APPLICATION / APLICACIÓN:

CITROËN: C4(LC_)2.0 HDi 11.04 100 136 1997, C4 Grand Picasso(UA_)2.0 HDi 10.06 100 136 1997, C4 Picasso(UD_)2.0 HDi 02.07 100 136 1997, C4(LA_)2.0 HDi 11.04 100 136 1997, C5(RD_)2.7 HDi 02.08 150 204 2720, C5 Break(TD_)2.7 HDi 02.08 150 204 2720, C6(TD_)2.7 HDi 09.05 150 204 2720;

PEUGEOT: 307(3A/C)2.0 HDi 135 10.03 100 136 1997, 307 Break(3E)2.0 HDi 135 02.04 100 136 1997, 307 CC(3B)2.0 HDi 135 06.05 100 136 1997, 307 SW(3H)2.0 HDi 135 02.04 100 136 1997, 407 (6C_)2.7 HDi 10.05 150 204 2720, 607 (9D,9U)2.7 HDi 24V 12.04 150 204 2721



GH5184

REPLACES / REEMPLAZA:

HELLA: 8ET 009 142-431; **SIEMENS:** 5WK97002; **CITROËN:** 1920.HH, 9645948980; **FORD:** 1 232 944, 3M5A12B579AB; **PEUGEOT:** 1920.HH, 9645948980; **VOLVO:** 1 232 944, 8 670 093

APPLICATION / APLICACIÓN:

CITROËN: C5(RC_)2.0 HDi(RCRHRH) 09.04 100 136 1997, C5(RD_)2.0 HDi 02.08 100 136 1997, C5 Break(RE_)2.0 HDi(RERHRH) 09.04 100 136 1997, C5 Break(TD_)2.0 HDi 02.08 100 136 1997, C8 (EA__EB_)2.0 HDi 02.07 88 120 1997, C8 (EA__EB_)2.2 HDi 06.06 125 170 2179, C-CROSSER(EP_)2.2 HDi 02.07 115 156 2179, JUMPY 2.0 HDi 120 01.07 88 120 1997, JUMPY 2.0 HDi 140 01.07 100 136 1997, JUMPY 2.0 HDi 120 01.07 88 120 1997, JUMPY 2.0 HDi 140 01.07 100 136 1997;

FORD: FOCUS C-MAX 2.0 TDCi 10.03-03.07 100 136 1997, FOCUS II(DA_)2.0 TDCi 11.04 100 136 1997, FOCUS II Turnier(DAW_)2.0 TDCi 11.04 100 136 1997, FOCUS II (DA_)2.0 TDCi 04.05 100 136 1997;

PEUGEOT: 407 (6D_)2.0 HDi 135 05.04 100 136 1997, 407 SW(6E_)2.0 HDi 135 05.04 100 136 1997;

VOLVO: S40 II(MS)2.0 D 01.04 100 136 1998, V50(MW)2.0 D 04.04 100 136 1998



GH5185

REPLACES / REEMPLAZA:

HELLA: 8ET 009 142-411; **HITACHI:** AFH70-08; **BVW:** 078 133 471 A

APPLICATION / APLICACIÓN:

AUDI: 100(4A,C4)2.8E 12.90-06.94 128 174 2771, 100(4A,C4)2.8E quattro 12.90-06.94 128 174 2771, 100 Avant(4A,C4)2.8E 09.91-06.94 128 174 2771, 100 Avant(4A,C4)2.8E quattro 09.91-06.94 128 174 2771, 80(8C,B4)2.8 09.91-12.94 128 174 2771, 80(8C,B4)2.8 quattro 09.91-12.94 128 174 2771, 80 Avant(8C,B4)2.8 09.91-01.96 128 174 2771, 80 Avant(8C,B4)2.8 quattro 08.92-07.95 128 174 2771, A4(8D2,B5)2.8 10.96-11.00 142 193 2771, A4(8D2,B5)2.8 quattro 10.96-11.00 142 193 2771, A4(8D2,B5)2.8 quattro 10.96-11.00 142 193 2771, A4(8D2,B5)2.8 quattro 01.95-07.97 128 174 2771, A4 Avant(8D5,B5)2.8 0.96-09.01 142 193 2771, A4 Avant(8D5,B5)2.8 quattro 03.96-09.96 128 174 2771, A4 Avant(8D5,B5)2.8 quattro 01.96-09.96 128 174 2771, A4 Avant(8D5,B5)2.8 quattro 10.96-09.01 142 193 2771, A6(4A,C4)2.8 12.95-10.97 142 193 2771, A6(4A,C4)2.8 quattro 06.94-10.97 128 174 2771, A6(4A,C4)2.8 quattro 12.95-10.97 142 193 2771, A6(4A,C4)2.8 quattro 06.94-10.97 128 174 2771, A6 Avant(4A,C4)2.8 06.94-12.97 128 174 2771, A6 Avant(4A,C4)2.8 quattro 12.95-12.97 142 193 2771, A6 Avant(4A,C4)2.8 quattro 06.94-12.97 128 174 2771, A8(4D2,4D8)2.8 04.96-09.02 142 193 2771, A8(4D2,4D8)2.8 quattro 07.95-03.96 120 163 2771, A8(4D2,4D8)2.8 quattro 03.94-03.96 128 174 2771, A8(4D2,4D8)2.8 quattro 04.96-09.02 142 193 2771, A8(4D2,4D8)2.8 quattro 07.95-03.96 120 163 2771, A8(4D2,4D8)2.8 quattro 03.94-03.96 128 174 2771, CABRIOLET(8G7,B4)2.6 06.93-08.00 110 150 2598, CABRIOLET(8G7,B4)2.6 quattro 05.95-08.00 102 139 2598, CABRIOLET(8G7,B4)2.8 11.92-08.00 128 174 2771, COUPE(89,8B)2.8 09.91-12.96 128 174 2771, COUPE(89,8B)2.8 quattro 09.91-12.96 128 174 2771



GH5186

REPLACES / REEMPLAZA:

HELLA: 8ET 009 142-451; **AUDI / SEAT / SKODA / VW:** 059 906 461 D, 059 906 461 DX, 059 906 461 G, 059 906 461 GX, 059 906 461 M; **HITACHI:** AFH70-25G, AFH70-25C

APPLICATION / APLICACIÓN:

AUDI: A4(8E2,B6)2.5 TDI 08.01-07.02 114 155 2496, A4(8E2,B6)2.5 TDI 07.02-12.04 120 163 2496, A4(8E2,B6)2.5 TDI quattro 11.00-12.04 132 180 2496, A4 Avant(8E5,B6)2.5 TDI 09.01-07.02 114 155 2496, A4 Avant(8E5,B6)2.5 TDI 07.02-12.04 120 163 2496, A4 Avant(8E5,B6)2.5 TDI quattro 09.01-12.04 132 180 2496, A4(8H7,8HE)2.5 TDI 08.02 120 163 2496, A6(4B,C5)2.5 TDI 02.00-01.05 132 180 2496, A6(4B,C5)2.5 TDI 08.01-01.05 114 155 2496, A6(4B,C5)2.5 TDI 07.02-01.05 120 163 2496, A6(4B,C5)2.5 TDI quattro 02.00-01.05 132 180 2496, A6 Avant(4B,C5)2.5 TDI 08.01-01.05 114 155 2496, A6 Avant(4B,C5)2.5 TDI 07.02-01.05 120 163 2496, A6 Avant(4B,C5)2.5 TDI quattro 02.00-01.05 132 180 2496, A8(4D2,4D8)2.5 TDI 09.00-09.02 132 180 2496, A8(4D2,4D8)2.5 TDI quattro 09.00-09.02 132 180 2496, ALLROAD(4BH)2.5 TDI quattro 05.00-08.05 132 180 2496, ALLROAD(4BH)2.5 TDI quattro 05.03-08.05 120 163 2496;

SKODA: SUPERB(3U4)2.5 TDI 02.02 114 155 2496, SUPERB(3U4)2.5 TDI 06.03 120 163 2496;

VW: PASSAT(3B3)2.5 TDI 11.00-05.05 110 150 496, PASSAT(3B3)2.5 TDI 05.03-05.05 120 163 2496, PASSAT(3B3)2.5 TDI 4motion 11.00-05.05 110 150 2496, PASSAT(3B3)2.5 TDI 4motion 01.03-05.05 132 180 2496, PASSAT Variant(3B6)2.5 TDI 11.00-05.05 110 150 2496, PASSAT Variant(3B6)2.5 TDI 05.03-05.05 120 163 2496, PASSAT Variant(3B6)2.5 TDI 4motion 11.00-05.05 110 150 2496, PASSAT Variant(3B6)2.5 TDI 4motion 01.03-05.05 132 180 2496



GH5187

REPLACES / REEMPLAZA:

HELLA: 8ET 009 142-271; **AUDI / SEAT / SKODA / VW:** 037 906 461BA; **HITACHI:** AFH60-10A

APPLICATION / APLICACIÓN:

VW: GOLF III(1H1)1.6 07.95-08.97 74 101 1595, GOLF III(1H1)2.0 11.91-08.97 85 115 1984, GOLF III Cabriolet(1E7)1.6 10.94-05.98 74 101 1595, GOLF III Cabriolet(1E7)2.0 07.93-05.98 85 115 1984, GOLF III Variant(1H5)1.6 07.94-04.99 74 101 1595, GOLF III Variant(1H5)2.0 07.93-04.99 85 115 1984, GOLF IV Cabriolet(1E7)1.6 06.98-06.02 74 100 1595, GOLF IV Cabriolet(1E7)2.0 06.98-06.02 85 115 1984, VENTO(1H2)2.0 11.91-09.98 85 115 1984



GH5188

REPLACES / REEMPLAZA:

HELLA: 8ET 009 142-361; **VW:** 078 133 471 C; **HITACHI:** AFH70-08C

APPLICATION / APLICACIÓN:

AUDI: A4(8D2,B5)2.4 03.97-11.00 121 165 2393, A4(8D2,B5)2.4 08.97-11.00 120 163 2393, A4(8D2,B5)2.4 quattro 03.97-11.00 121 165 2393, A4(8D2,B5)2.8 10.96-11.00 142 193 2771, A4(8D2,B5)2.8 quattro 10.96-11.00 142 193 2771, A4 Avant(8D5,B5)2.4 08.97-09.01 120 163 2393, A4 Avant(8D5,B5)2.4 3.97-09.01 121 165 2393, A4 Avant(8D5,B5)2.4 quattro 03.97-09.01 121 165 2393, A4 Avant(8D5,B5)2.8 10.96-09.01 142 193 2771, A4 Avant(8D5,B5)2.8 Quattro 10.96-09.01 142 193 2771, A6 (4B,C5)2.4 02.97-01.05 121 165 2393, A6 (4B,C5)2.4 02.97-01.05 120 163 2393, A6 (4B,C5)2.4 02.97-01.05 115 156 2393, A6 (4B,C5)2.4 quattro 02.97-01.05 121 165 2393, A6 (4B,C5)2.4 quattro 02.97-01.05 120 163 2393, A6 (4B,C5)2.8 10.97-07.98 132 180 2771, A6 (4B,C5)2.8 02.97-01.05 142 193 2771, A6 (4B,C5)2.8 quattro 02.97-01.05 142 193 2771, A6 Avant(4B,C5)2.4 12.97-01.05 121 165 2393, A6 Avant(4B,C5)2.4 quattro 12.97-01.05 120 163 2393, A6 Avant(4B,C5)2.8 12.97-01.05 142 193 2771, A6 Avant(4B,C5)2.8 quattro 12.97-01.05 142 193 2771, A8 (4D2,4D8)2.8 04.96-09.02 142 193 2771, A8 (4D2,4D8)2.8 quattro 04.96-09.02 142 193 2771;

VW: PASSAT(3B2)2.8 V6 05.97-09.99 132 180 2771, PASSAT(3B2)2.8 V6 08.96-11.00 142 193 2771, PASSAT(3B2)2.8 V6 Syncro/4motion 10.96-11.00 142 193 2771, PASSAT Variant(3B5)2.8 V6 09.97-09.99 132 180 2771, PASSAT Variant(3B5)2.8 V6 06.97-11.00 142 193 2771, PASSAT Variant(3B5)2.8 V6 Syncro/4motion 06.97-11.00 142 193 2771

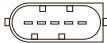

GH5191

REPLACES / REEMPLAZA:

BOSCH: 0 281 002 384; **MERCEDES-BENZ:** 000 094 14 48

APPLICATION / APLICACIÓN:

MERCEDES: C-CLASS(W202) C 200 CDI (202.134) 03.98-05.00 75 102 2151, C-CLASS(W202) C 220 CDI (202.133) 09.97-05.00 92 125 2151, C-CLASS(S202) C 200 CDI (202.194) 03.98-03.01 75 102 2151, C-CLASS(S202) C 220 CDI (202.193) 09.97-03.01 92 125 2151



GH5192

REPLACES / REEMPLAZA:

BOSCH: 0 280 218 096; **NISSAN:** 22680 6N210, 22680 7J500

APPLICATION / APLICACIÓN:

NISSAN: ALMERA TINO(V10)2.0 08.00 100 136 1998, PRIMERA(P11)2.0 16V 08.99-12.01 103 140 1998, PRIMERA(P12)2.0 03.02 103 140 1998, PRIMERA Hatchback(P11)2.0 16V 08.99-07.02 103 140 1998, PRIMERA Hatchback(P12)2.0 07.02 103 140 1998, PRIMERA Traveller(WP11)2.0 16V 08.99-12.01 103 140 1998, PRIMERA (WP12)2.0 03.02 103 140 1998

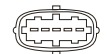

GH5193

REPLACES / REEMPLAZA:

BOSCH: 0 280 218 088; **VOLVO:** 8627296, 8670115, 8670398

APPLICATION / APLICACIÓN:

VOLVO: C70 2.0 T 03.00-10.05 120 163 1984, C70 2.3 T5 07.02-10.05 180 245 2319, C70 2.4 T 07.02-10.05 147 200 2435, S60 2.0 T 09.01 132 180 1984, S60 2.4 D 12.01 96 130 2401, S60 2.4 D5 07.01 120 163 2401, S60 2.4 T 11.00 147 200 2435, S60 2.4 T AWD 11.01 147 200 2435, S60 2.5 02.04 154 210 2521, S60 2.5 T AWD 04.04 154 210 2521, S60 T5 11.00 184 250 2319, S80 (TS.XY)2.0 T 12.99-07.06 132 180 1984, S80 (TS.XY)2.3 R 04.00-08.05 195 265 2319, S80 (TS.XY)2.4 D 10.01-07.06 96 131 2401, S80 (TS.XY)2.4 D5 08.01-07.06 120 163 2401, S80 (TS.XY)2.4 LTP 06.04-07.06 132 179 2435, S80 (TS.XY)2.4 T 06.00-07.06 147 200 2435, S80 (TS.XY)2.4 T5 AWD 04.00-09.03 147 200 2435, S80 (TS.XY)2.5 T 03.03-07.06 154 210 2521, S80 (TS.XY)2.5 T AWD 07.03-07.06 154 210 2521, S80 (TS.XY)3.0 06.01-07.06 144 196 2922, V70 II(P80_)2.0 T 07.01 132 180 1984, V70 II(P80_)2.3 T5 03.00 184 250 2319, V70 II(P80_)2.4 D 12.01 96 131 2401, V70 II(P80_)2.4 D5 08.01 120 163 2401, V70 II(P80_)2.4 D5 12.05 136 185 2401, V70 II(P80_)2.4 D5 AWD 03.03 120 163 2401, V70 II(P80_)2.4 T 03.00 147 200 2435, V70 II(P80_)2.4 T AWD 09.01 147 200 2435, V70 II(P80_)2.5 T 04.04 154 209 2521, V70 II(P80_)2.5 T AWD 09.02 154 209 2521, XC 90 2.5 T 10.02 154 209 2521, XC 90 D5 10.02 120 163 2401, XC70 CROSS COUNTRY 2.4 D5 XC AWD 09.02 120 163 2401, XC70 CROSS COUNTRY 2.4 T XC AWD 03.00-09.02 147 200 2435, XC70 CROSS COUNTRY 2.5 T XC AWD 09.02 154 209 2521

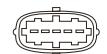

GH5194

REPLACES / REEMPLAZA:

BOSCH: 0 281 002 212; **SCANIA:** 4662888

APPLICATION / APLICACIÓN:

SAAB 9-3(YS3D) 2.2 TiD 11.00-09.02 92 125 2171, 9-3(YS3D) 2.2 TiD 02.98-11.00 85 115 2171

GH5195

REPLACES / REEMPLAZA:

BOSCH: 0 281 002 120; **HONDA:** 16400 P5T G00; **ROVER:** MHK 1003 60

APPLICATION / APLICACIÓN:

HONDA: ACCORD VI (CE,CF)2.0 TD(CF1) 04.96-10.98 77 105 1994, ACCORD VII (CG)2.0 Turbo Di 02.99-12.02 77 105 1994, ACCORD VII Hatchback(CH)2.0 TDi 12.99-10.00 77 105 1994, CIVIC V Aerodeck (MC) 2.0 i D (MC3) 04.98-02.01 77 105 1994, CIVIC V Fastback (MB) 2.0 i TD (MB7) 01.97-02.01 63 86 1994;

ROVER: 200 (RF)220 D/SD 11.95-03.00 63 86 1994, 200 (RF)220 SDi 11.95-03.00 77 105 1994, 25 (RF)2.0 i DT 10.99 74 101 1994, 400(RT)420 D 11.95-03.00 63 86 1994, 400(RT)420 Di 05.95-03.00 77 105 1994, 400(RT)420 D 11.95-03.00 63 86 1994, 400(RT)420 Di 05.95-03.00 77 105 1994, 45(RT)2.0 i DT 02.00 74 101 1994, 45(RT)2.0 i DT 02.00 74 101 1994, 600(RH)620 Sdi 12.94-02.99 77 105 1994

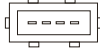

GH5196

REPLACES / REEMPLAZA:

BOSCH: 0 281 002 195; **RENAULT:** 77 00 100 572, 7 700 874 671

APPLICATION / APLICACIÓN:

RENAULT: MEGANE Classic(LA0/1_)1.9 dTi(LA08,LA0N) 03.97-02.01 72 98 1870,MEGANE I(BA0/1_)1.9 dTi(BA08,BA0N) 03.97-02.01 72 98 1870

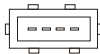

GH5197

REPLACES / REEMPLAZA:

BOSCH: 0 280 218 094; **NISSAN:** 22680 5U400

APPLICATION / APLICACIÓN:

NISSAN: ALMERA II(N16)1.5 10.02 72 98 1497, ALMERA II(N16)1.8 10.02 85 116 1769, ALMERA II(N16)1.8 07.00 84 114 1769, ALMERA II Hatchback(N16)1.5 10.02 72 98 1497, ALMERA II Hatchback(N16)1.5 03.00 66 90 1498, ALMERA II Hatchback(N16)1.8 10.02 85 116 1769, ALMERA II Hatchback(N16)1.8 03.00 84 114 1769, ALMERA TINO (V10)1.8 12.02 85 116 1769, ALMERA TINO (V10)1.8 08.00 84 114 1769, PRIMERA(P11)1.6 16V 06.96-12.01 78 106 1597, PRIMERA(P11)1.8 16V 08.99-12.01 84 114 1769, PRIMERA(P12)1.6 03.02 78 106 1597, PRIMERA(P12)1.6 01.02 80 109 1597, PRIMERA(P12)1.8 03.02 85 115 1769, PRIMERA Hatchback(P11)1.6 16V 09.00-07.02 78 106 1597, PRIMERA Hatchback(P11)1.8 16V 08.99-07.02 84 114 1769, PRIMERA Hatchback(P12)1.6 07.02 80 109 1597, PRIMERA Hatchback(P12)1.6 07.02 78 106 1597, PRIMERA Hatchback(P12)1.8 07.02 85 115 1769, PRIMERA Traveller(WP11)1.8 16V 08.99-12.01 84 114 1769, PRIMERA (WP12)1.6 Visia 01.02 80 109 1597, PRIMERA (WP12)1.8 03.02 85 115 1769,



GH5198

REPLACES / REEMPLAZA:

BOSCH: 0 281 002 482; **HONDA:** 16400 PLZ E01, 16400 PLZ E011

APPLICATION / APLICACIÓN:

HONDA: CIVIC VI Hatchback(EU_EP_)1.7 CTDi 01.02-09.05 74 100 1686

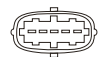

GH5199

REPLACES / REEMPLAZA:

BOSCH: 0 280 217 105; **KIA:** 0K080-13-210, 0K011-13-210B; **SAAB:** 9210 930 006, 9128 919

APPLICATION / APLICACIÓN:

KIA: SPORTAGE (K00)2.0 i 16V 4WD 04.94-08.03 94 128 1998, SPORTAGE (K00)2.0 i 4WD 04.94-08.99 70 95 1998;

SAAB: 900 II 2.0-16 Turbo 07.93-02.98 136 185 1985, SAAB 900 II 2.0 i 08.94-02.98 96 131 1985, SAAB 900 II 2.3-16 07.93-02.98 110 150 2290, SAAB 900 II 2.5-24 V6 07.93-02.98 125 170 2498, SAAB 900 II 2.0-16 Turbo 12.93-02.98 136 185 1985, SAAB 900 II 2.0 i 12.93-02.98 96 131 1985, SAAB 900 II 2.3-16 12.93-02.98 110 150 2290, SAAB 900 II 2.0-16 Turbo 12.93-02.98 136 185 1985, SAAB 900 II 2.0 i 08.94-02.98 96 131 1985, SAAB 900 II 2.0 i 12.93-07.94 98 133 1985, SAAB 900 II 2.3-16 12.93-02.98 110 150 2290, SAAB 900 II 2.5-24 V6 12.93-02.98 125 170 2498

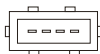

GH5200

REPLACES / REEMPLAZA:

BOSCH: 0 281 002 443; **SCANIA:** 5166541, 5167879

APPLICATION / APLICACIÓN:

SAAB: 9-3 (YS3D) 2.2 TiD 11.00>09.02 92 125 2171, 9-3(YS3D) 2.2 TiD 02.98>11.00 85 115 2171

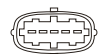



GH5201

REPLACES / REEMPLAZA:

BOSCH: 0 280 212 007; **VOLVO:** 1346645, 3411906, 8251496, 8602791, 091 22 2 A

APPLICATION / APLICACIÓN:

VOLVO: 240 (P242,P244)2.3 08.86>07.87 83 113 2315, 240 (P242,P244) 2.3 i 08.86>07.93 85 115 2316, 240 Kombi (P245)2.3 08.86>07.87 83 113 2316, 240 Kombi(P245)2.3 i 08.86>07.93 85 115 2316, 440 K(445) 1.7 08.88>07.89 70 95 1721, 440 K(445) 1.7 Turbo 08.88>07.96 88 120 1721, 460 L(464) 1.7 Turbo 08.89>07.96 88 120 1721, 480 E 1.7 Turbo 01.91>07.96 90 122 1721, 480 E 1.7 Turbo 08.87>07.96 88 120 1721, 740 (744) 2.3 08.87>07.92 85 115 2316, 740 (744) 2.3 09.85>12.89 83 113 2316, 740 (744) 2.3 Turbo 08.86>07.89 115 156 2316, 740 Kombi (745) 2.3 08.87>07.92 85 115 2316, 740 Kombi (745)2.3 Turbo 08.86>07.89 115 156 2316, 760 (704,764) 2.3 01.88>07.92 119 162 2316, 940 (944) 2.0 GL 09.90>04.92 103 140 1986



GH5202

REPLACES / REEMPLAZA:

BOSCH: 0 986 280 108, 0 280 212 014; **SAAB:** 75 91 183, 88 23 239

APPLICATION / APLICACIÓN:

SAAB: 9000 2.0-16 12.85>12.88 92 125 1985, 9000 2.0-16 12.85>08.88 94 128 1985



GH5203

REPLACES / REEMPLAZA:

BOSCH: 0 986 280 101, 0 280 212 016; **VOLVO:** 3517020, 8251497, 8602792

APPLICATION / APLICACIÓN:

VOLVO: 240 (P242,P244) 2.3 i 08.86>07.93 85 115 2316, 240 Kombi (P245)2.3 i 08.86>07.93 85 115 2316, 740 (744)2.0 09.88>08.90 76 103 1986, 740 (744) 2.3 08.87>07.92 85 115 2316, 740 (744) 2.3 08.87>07.89 117 159 2316, 740 (744) 2.3 08.88>08.92 111 151 2316, 740 (744) 2.3 08.88>07.91 114 156 2316, 740 (744) 2.3 09.85>12.89 83 113 2315, 740 (744) 2.3 Turbo 08.89>07.90 121 165 2316, 740 (744) 2.3 Turbo 08.89>07.90 140 190 2316, 740 Kombi (745) 2.0 08.89>08.90 76 103 1986, 740 Kombi (745) 2.0 08.89>07.91 82 112 1986, 740 Kombi (745) 2.3 08.87>07.89 117 159 2316, 740 Kombi (745) 2.3 08.87>07.92 85 115 2316, 740 Kombi (745) 2.3 08.88>07.90 114 156 2316, 740 Kombi (745) 2.3 07.89>08.92 111 151 2316, 740 Kombi (745) 2.3 Turbo 08.89>07.90 121 165 2316, 760 (704,764) 2.3 01.88>07.92 119 162 2316, 940 (944) 2.0 01.92>07.94 82 112 1986, 940 (944)2.0 Turbo 04.96>10.98 114 155 1986, 940 (944) 2.3 08.90>07.91 114 156 2316, 940 (944) 2.3 08.90>12.94 96 131 2316, 940 (944) 2.3 08.92>07.94 85 116 2316, 940 (944) 2.3 Turbo 08.90>07.94 121 165 2316, 940 II (944) 2.0 Turbo 04.96>10.98 114 155 1986, 940 II (944) 2.3 08.94>07.95 85 116 2316, 940 II (944) 2.3 08.94>10.98 96 131 2316, 940 II (944) 2.3 ti 01.95>10.98 99 135 2316, 940 II (944) 2.3 Turbo 08.94>10.98 121 165 2316, 940 II (945) 2.0 Turbo 04.96>10.98 114 155 1986, 940 II (945) 2.3 08.94>07.95 85 116 2316, 940 II (945) 2.3 08.94>10.98 96 131 2316, 940 II (945) 2.3 10.94>05.97 113 154 2316, 940 II (945) 2.3 ti 01.95>10.98 99 135 2316, 940 II (945) 2.3 Turbo 08.94>10.98 121 165 2316, 940 Kombi (945) 2.0 01.92>07.94 82 112 1986, 940 Kombi (945) 2.3 08.90>07.91 114 155 2316, 940 Kombi (945) 2.3 08.90>12.94 96 131 2316, 940 Kombi (945) 2.3 08.92>07.94 85 116 2316, 940 Kombi (945) 2.3 Turbo 08.90>07.94 121 165 2316, 960 (964) 2.0 09.90>08.93 103 140 1986, 960 Kombi (965) 2.0 09.90>08.93 103 140 1986



GH5204

REPLACES / REEMPLAZA:

BOSCH: 0 281 002 489; **MERCEDES-BENZ:** 004 153 73 28

APPLICATION / APLICACIÓN:

MERCEDES: A-CLASS (W168)A 160 CDI (168.006) 02.01>08.04 55 75 1689, A-CLASS (W168)A 160 CDI (168.007) 07.98>02.01 44 60 1689, A-CLASS (W168)A 170 CDI (168.008) 07.98>02.01 66 90 1689, A-CLASS (W168)A 170 CDI (168.009,168.109) 02.01>08.04 70 95 1689, Vaneo (414) 1.7 CDI (414.700) 02.02 67 91 1689, Vaneo (414) 1.7 CDI (414.700) 02.02 55 75 1689



GH5205

REPLACES / REEMPLAZA:

PIERBURG: 7.28342.06.0; **CITROËN:** 96.500.107.80; **FORD:** 1 232 096,1 255 117, 3M5A12B579BA, 3M5A12B579BB; **MAZDA:** Y601 13215; **PEUGEOT:** 1920.GV; **VOLVO:** 30774680

APPLICATION / APLICACIÓN:

CITROËN: C3(FC_)1.6 16V HDi 10.05 66 90 1560, C4(LC_)1.6 HDi 11.04 66 90 1560, C4(LC_)1.6 HDi 11.04 80 109 1560, C4(LA_)1.6 HDi 11.04 66 90 1560, C4(LA_)1.6 HDi 11.04 80 109 1560, C5(RC_)1.6 HDi(RC8HZB) 09.04 80 109 1560, C5 Break(RE_)1.6 HDi(RE8HZB) 09.04 80 109 1560, XSARA PICASSO (N68) 1.6 HDi 05.04 80 109 1560, XSARA PICASSO (N68) 1.6 HDi 09.05 66 90 1560;

FORD: FIESTA V(JH_JD_)1.6 TDCi 11.04 66 90 1560, FOCUS C-MAX 1.6 TDCi 10.03-03.07 80 109 1560, FOCUS C-MAX 1.6 TDCi 02.05-03.07 66 90 1560, FOCUS II(DA_)1.6 TDCi 11.04 80 109 1560, FOCUS II(DA_)1.6 TDCi 01.05 66 90 1560, FOCUS II Turnier(DAW_)1.6 TDCi 11.04 80 109 1560, FOCUS II (DA_)1.6 TDCi 04.05 80 109 1560, FUSION(JU_)1.6 TDCi 11.04 66 90 1560;

MAZDA: 3 (BK14)1.6 DI Turbo 06.04 80 109 1560, 3 (BK12)1.6 DI Turbo 06.04 80 109 1560;

PEUGEOT: 1007(KM_)1.6 HDi 06.07 80 109 1560, 206(2A/C)1.6 HDi 11.05 04 80 109 1560, 307(3A/C)1.6 HDi 11.05 04 80 109 1560, 307 Break (3E)1.6 HDi 11.05 04 80 109 1560, 307 SW (3H)1.6 HDi 11.05 04 80 109 1560, 308 (4A_4C_)1.6 HDi 09.07 66 90 1560, 407 (6D_)1.6 HDi 11.05 04 80 109 1560, 407 SW (6E_)1.6 HDi 11.05 04 80 109 1560, EXPERT Tepee(VF3V_)1.6 HDi 90 01.07 66 90 1560, EXPERT (VF3A_VF3U_VF3X_)1.6 HDi 90 01.07 66 90 1560, EXPERT 1.6 HDi 90 01.07 66 90 1560;

VOLVO: C30 1.6 D 10.06 80 109 1560, S40 II(MS) 1.6 D 01.05 81 110 1560, V50(MW) 1.6 D 01.05 81 110 1560

GH5207

REPLACES / REEMPLAZA:

PIERBURG: 7.22184.06.0; **FORD:** 4 138 872, 1L 5F12B579 AB

APPLICATION / APLICACIÓN:

FORD: FOCUS (DAW,DBW)RS 10.02-11.04 158 215 1988, FOCUS (DAW,DBW)ST170 03.02-11.04 127 173 1988, FOCUS (DNW)ST170 09.02-11.04 127 173 1988, MONDEO I(GBP)2.5 i 24V 07.94-08.96 125 170 2544, MONDEO I(BNP)2.5 i 24V 07.94-08.96 125 170 2544, MONDEO I(GBP)2.5 i 24V 07.94-08.96 125 170 2544, MONDEO II(BAP)2.5 24V 09.96-11.00 125 170 2544, MONDEO II(BAP)2.5 24V 06.00-11.00 125 170 2495, MONDEO II(BAP)2.5 ST 200 05.99-11.00 151 205 2495, MONDEO II(BNP)2.5 24V 09.96-11.00 125 170 2544, MONDEO II(BNP)2.5 24V 06.00-11.00 125 170 2495, MONDEO II(BNP)2.5 ST 200 05.99-11.00 151 205 2495, MONDEO II(BFP)2.5 24V 09.96-11.00 125 170 2544, MONDEO II(BFP)2.5 24V 06.00-11.00 125 170 2495, MONDEO II(BFP)2.5 ST 200 05.99-11.00 151 205 2495, MONDEO III(B5Y)2.5 V6 24V 11.00 125 170 2495, MONDEO III(B5Y)3.0 V6 24V 09.04 150 204 2967, MONDEO III(B5Y)ST220 04.02 166 226 2967, MONDEO III(BWY)2.5 V6 24V 11.00 125 170 2495, MONDEO III(BWY)3.0 V6 24V 09.04 150 205 2967, MONDEO III(BWY)ST220 04.02 166 226 2967, MONDEO III(B4Y)2.5 V6 24V 11.00 125 170 2495, MONDEO III(B4Y)3.0 V6 24V 09.04 150 204 2967, MONDEO III(B4Y)ST220 04.02 166 226 2967

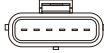

GH5209 // NEW //

REPLACES / REEMPLAZA:

BOSCH: 0 280 218 209, 0 280 218 423; **GM:** 13 241 771

APPLICATION / APLICACIÓN:

GM: Aveo Hatchback 2011>, Cruze 2009>, Cruze Hatchback 2010>, Cruze Station Wagon 2012>, Orlando 2010>, Volt 2011>;
OPEL: Adam 2012>, Ampera 2011>, Astra J 2009>, Astra GTC J 2011>, Astra J Sports Tourer 2010>, Astra K 2015>, Astra K Sport Tou



GH5210

REPLACES / REEMPLAZA:

VDO: 5WK9635; **VOLGA:** TY37.473.017-99

APPLICATION / APLICACIÓN:

VOLGA

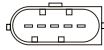

GH5211

REPLACES / REEMPLAZA:

AC **DELCO:** 213 4160; **GM:** 15904068, 213364, 25318411; **CARDONE:** 86-8411

APPLICATION / APLICACIÓN:

CADILLAC: Rainier 5.3L 2004-2005, Deville 4.6L 2003-2005, Seville 4.6L 2003-2004, Deville 5.7L 2000-2002, Eldorado 5.7L 2000-2002, Seville 5.7L 2000-2002, CTS 5.7L 2004-2005, Escalade 5.3L 2002-2005, Escalade 6.0L 2002-2006, Escalade ESV 6.0L 2003-2006, Escalade EXT 6.0L 2003-2006;
CHEVROLET: Corvette (VIN Code G) 5.7L 2002-2004, Corvette 5.7L 2001, Corvette 6.0L 2005-2007; **CHEVROLET/GMC TRUCKS:** Sierra, Silverado 4.3L 1999-2006, Sierra/ Silverado 4.8L 1999-2006, Tahoe/ Yukon 4.8L 2000-2006, Avalanche 5.3L 2003-2006, Sierra/ Silverado 5.3L 2003-2006, Suburban/ Yukon XL 5.3L 2003-2006, Tahoe/ Yukon 5.3L 2003-2006, Trailblazer/ Envoy 5.3L 2003-2006, SSR w/o Internal Air Temp. Sensor 5.3L 2003-2004, All 5.3L 1999-2002, Sierra/ Silverado/ Suburban/ Yukon XL 6.0L 2003-2006, SSR w/o Internal Air Temp. Sensor 6.0L 2005-2006, All 6.0L 1999-2002, All 8.1L 2003-2006, All Exc. G Series 8.1L 2001-2002; **CHEVROLET/GMC TRUCKS(Medium Duty)** C4,C5 w/o Temp. Sensor 6.6L 2005-2006, All 8.1L 2001-2006; **PONTIAC:** Bonneville 4.6L 2005, GTO 6.0L 2005-2006, 9-7X 4.2L 2005-2006, 9-7X 5.3L 2005-2006, Oldsmobile Aurora 4.0L 2001-2003; **ISUZU:** 5.3L 2003-2006



GH5212

REPLACES / REEMPLAZA:

AC **DELCO:** 213 4527, 213 352; **GM:** 19207202, 1570276, 25180303; **DELPHI:** AF10045; **CARDONE:** 86-8309

APPLICATION / APLICACIÓN:

BUICK: ALL V6 3.1L 1999-2005, ALL V6 3.4L 2005, ALL V8 5.7L 1994-1996, Skylak V6 3.1L 1996-1998, Roadmaster V8 5.7L 1994-1996, Rendezvous V6 3.4L 2002-2005; **CADILLAC:** ALL V8 5.7L 1994-1995; **CHEVROLET:** ALL V6 3.1L 2002-2003, ALL V8 4.3L 1994-1996, Astro ALL ALL 1996-2005, Beretta V6 3.1L 1996, Blazer ALL ALL 1996-2005, Caprice V8 5.7L 1994-1996, Commercial Chassis ALL ALL 1994, Corsia V6 3.1L 1996, Impala ALL ALL 1994-1996, Impala V6 3.4L 2005, Lumina APV V6 3.4L 1996, Lumina ALL ALL 2000-2001, Lumina V6 3.1L 1994, Lumina V6 3.1L 1995-1999, Lumina V6 3.4L 1994-1997, Malibu ALL ALL 2000-2001, Malibu V6 3.1L 1997-1999, Monte Carlo V6 3.4L 1995-1997, Monte Carlo V6 3.4L 2005, S10 ALL ALL 2004, S10 V6 4.3L 1996-20034, Venture ALL ALL 2005, Venture V6 3.4L 1997, Venture V6 3.4L 2000-2004. **GMC:** Jimmy ALL ALL 1996-2001, Jimmy ALL ALL 1998-2000, Safari ALL ALL 1996-2005, Sonoma ALL ALL 2004, Sonoma V6 4.3L 1996-2003, **OLDSMOBILE:** ALL V6 3.1L 1998-1999, ALL V6 3.5L 1999-2000, ALL V6 4.3L 1996-2001, Achieva V6 3.1L 1996, Achieva V6 3.1L 1996-1997, Alero V6 3.4L 1999-2004, Cutlass Supreme V6 3.4L 1996, Cutlass ALL ALL 1997, Intrigue ALL ALL 2001-2002, Sihouette V6 3.4L 1996, Sihouette V6 3.4L 1999-2004, Bravada 4.3L 1996-2001; **PONTIAC:** Aztek ALL ALL 2001-2005, Aztek V6 3.4L 2002-2005, Aztek V6 3.4L 2003-2004, Grand Am V6 3.1L 1996-1998, Grand Am V6 3.4L 1999-2005, Grand Prix V6 3.1L 1994-1998, Grand Prix V6 3.4L 1994-1996, Montana ALL ALL 2001-2004, Montana V6 3.4L 2000-2005, Trans Spot V6 3.4L 1996; **ISUZU:** Rodeo 3.2L 1998-2004, Amigo 3.2L 1998-2000, Axiom 3.5L 2002-2003, Trooper 3.5L 1998-2002, Vehicross 3.5L 1999-2001, Hombre 4.3L 1996-2000

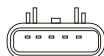

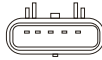

GH5213

REPLACES / REEMPLAZA:

AC **DELCO**: 213 4657; **GM**: 19207203, 25179711; **DELPHI**: AF10044; **CARDONE**: 86-8308

APPLICATION / APLICACIÓN:

CADILLAC: Escalade 5.7L 1999-2000; **CHEVROLET**: Camaro 5.7L 2001-2002, All 5.7L 1987-2000, Camaro 5.7L 1994-1996, Corvette 5.5L 1994-1996, All 7.4L 1999-2000; **CHEVROLET/GMC TRUCKS**: G Series Van 4.3L 1996-2002, P Series Van 4.3L 1996-1999, C.K Series Pickup 4.3L 1996-1998, G Series Van 5.0L 2000-2002, All 5.0L 1996-1999, G Series Van 5.7L 2001-2002, All 7.4L 1996-2000, G Series Van 8.1L 2001-2002, (Medium Duty) All 7.4L 1999-2000; **PONTIAC**: Firebird 5.7L 1994-2002, GTO 5.7L 2004



GH5215

REPLACES / REEMPLAZA:

FORD: F07Z12B579A, F07F-12B579-A2C, F07Z 12B579-AARM, AFLS-102-RM; **CARDONE**: 74-9525

APPLICATION / APLICACIÓN:

FORD: AEROSTAR 6 Cyl 3.0L 1990-1995, AEROSTAR 6 Cyl 4.0L 1990-1995, BRONCO 8 Cyl 5.0L 1994, E-150 ECONOLINE 8 Cyl 5.0L 1994, EXPLORER 6 Cyl 4.0L 1991-1995, F-150 PICKUP 8 Cyl 5.0L 1994, F-250 PICKUP 8 Cyl 5.0L 1994, RANGER 6 Cyl 3.0L 1993-1995, RANGER 6 Cyl 4.0L 1995, RANGER 6 Cyl 4.0L 1990-1994, LINCOLN TOWN CAR 8 Cyl 4.6L 1991-1992; **MAZDA**: B4000 6 Cyl 4.0L 1994, NAVAJO 6 Cyl 4.0L 1991-1994 MERCURY GRAND MARQUIS 8 Cyl 4.6L 1992

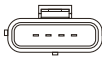

GH5216

REPLACES / REEMPLAZA:

FORD: F67F-12B579-EA, F67Z-12B579-EBRM, AFLS-124-RM; **CARDONE**: 74-9526

APPLICATION / APLICACIÓN:

FORD: Ranger 2.3L 1995-1997; Ranger 2.5L 1998-2001, Ranger 3.0L 1999-2000, Taurus w/12 Valve Eng. 3.0L 1996-1999, Escort 1.9L 1996, Escort w/I.D. # F67F 12B579-EA 2.0L 2001-2002; **MAZDA**: 626 2.0L 1998-2001, B2500 Pickup 2.5L 1998-2001, B2300 Pickup 2.3L 1995-1997, B3000 Pickup 3.0L 1996-2000; **MERCURY**: Tracer 1.9L 1996, Tracer 2.0L 1999, Sable 3.0L 1996-1999

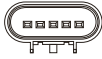

GH5217

REPLACES / REEMPLAZA:

AC **DELCO**: 213-1677; **GM**: 15911983; **CARDONE**: 74-50015

APPLICATION / APLICACIÓN:

BUICK: All 3.8L 1999-2004, Lesabre 3.8L 2005, Park Avenue 3.8L 2005; **CHEVROLET**: Impala 3.8L 1999-2005, Monte Carlo 3.8L 1999-2005, Camaro 3.8L 1999-2002; **OLDSMOBILE**: All 3.8L 1999; **PONTIAC**: Bonneville 3.8L 2004-2005, All 3.8L 1999-2003

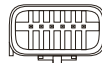

GH5218

REPLACES / REEMPLAZA:

FORD: 3L3Z-12B579-BA, 3L3A-12B579-BA, AFLS-131, 4515688; **CARDONE**: 74-50031

APPLICATION / APLICACIÓN:

FORD: Focus II Turnier (DAW-) 1.6 Ti 85KW 115HP 1596cc 11.04, Focus II (DA-) 1.6 Ti 85KW 115HP 1596cc 04.05, Focus 2.0L 2005-2007, Focus 2.3L 2004-2007, Fusion 2.3L 2006-2007, Fusion 3.0L 2007, Five Hundred 3.0L 2005-2006, Fusion 3.0L 2005-2006, Taurus 3.0L 2005-2006, Taurus 4.0L 2004, Mustang 4.0L 2005-2006, Thunderbird 3.9L 2004-2005, Crown Victoria 4.6L 2006, Mustang 4.6L 2006; **LINCOLN**: Zephyr 3.0L 2006, LS 3.0L 2003-2005, LS 3.9L 2003-2006, Town Car 4.6L 2005-2006, Mark LT 5.4L 2006, Navigator 5.4L 2006; **MERCURY**: Milan 2.3L 2006-2007, Milan 3.0L 2005-2007, Montego 3.0L 2005-2006, Sable 3.0L 2004-2005, Grand Marquis 4.6L 2005-2006, Mariner 2.3L 2005-2006, Mountaineer 4.0L 2006, Monterey 4.2L 2004-2006

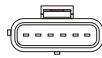

GH5219

REPLACES / REEMPLAZA:

FORD: 3L3Z-12B579-BA, 3L3A-12B579-BA, AFLS-131, 4515688; **CARDONE**: 74-50031

APPLICATION / APLICACIÓN:

FORD: Focus 2.0L 2003-2004, Escort 2.0L 2003-2004, Escape 2.0L 2001-2004, Ranger 2.3L 2001-2003, Escape 3.0L 2001-2006, Windstar 3.8L 1999-2003, Explorer 4.0L 1999-2005, E150 4.2L 2001-2004, E250 Van 4.2L 2001-2004, Explorer 5.0L 1999-2001



GH5220

REPLACES / REEMPLAZA:

FORD: XW4F-12B579-AA; **HITACHI:** AFH70-18, SM11; **CARDONE:** 86-9563

APPLICATION / Aplicación:

FORD: Natural Gas 00>02 4.6L, Crown Victoria 99 4.6L, Lincoln Town Car 96>99 4.6L, Mercury Grand Marquis 95>97 4.6L



GH5222

REPLACES / REEMPLAZA:

U08004-AFS; **HITACHI:** AFH50-06; **NISSAN:** 22680-53J00

APPLICATION / APLICACIÓN:

NISSAN: Sentra 2.0L1991-1994, NX 2.0L 1991-1993, INFINITI G20 2.0L 1991-1995

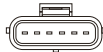

GH5223

REPLACES / REEMPLAZA:

FORD: F8LF-12B579-AA; **HITACHI:** AFH80-01A; **CARDONE:** 86-9524

APPLICATION / APLICACIÓN:

FORD: FORD MUSTANG 4.6L 1996-1998

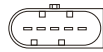

GH5226

REPLACES / REEMPLAZA:

BOSCH: 0 280 218 039, 0 280 218 038, 0 986 280 312; **AUDI/VW:** 078 906 461BX, 078 906 461B

APPLICATION / APLICACIÓN:

AUDI: A4 (8D2,B5) S4 quattro 09.97-11.00 195KW 265HP 2671CC, A4 Avant (8D5,B5) S4 quattro 09.97-09.01 195KW 265HP 2671CC, A6 (4B,C5) 2.7T 02.99-01.05 169KW 230HP 2671CC, A6 (4B,C5) 2.7T quattro 12.97-01.05 169KW 230HP 2671CC, A6 Avant (4B,C5) 2.7T 02.99-01.05 169KW 230HP 2671CC, A6 Avant (4B,C5) 2.7T quattro 12.97-01.05 169KW 230HP 2671CC

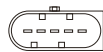

GH5229

REPLACES / REEMPLAZA:

BOSCH: 0 280 218 058, 0 986 280 315; **AUDI/VW:** 06B 133 471A, 06B 133 471AX

APPLICATION / APLICACIÓN:

AUDI: A4 (8E2,B6) 2.011.00-12.04 96KW 130HP 1984CC, A4 (8E2,B6) 2.0 FSI 07.02-12.04 110KW 150HP 1984CC, A4 (8EC) 2.0 11.04 96KW 130HP 1984CC, A4 Avant (8E5,B6) 2.0 09.01-12.04 96KW 130HP 1984CC, A4 Avant (8E5,B6) 2.0 FSI 07.02-12.04 110KW 150HP 1984CC, A4 Avant (8ED) 2.0 11.04 96KW 130HP 1984CC, A4 (8H7,8HE) 2.0 09.04-12.05 96KW 130HP 1984CC, A6 (4B,C5) 2.0 08.01-01.05 96KW 130HP 1984CC, A6 Avant (4B,C5) 2.0 08.01-01.05 96KW 130HP 1984CC; **VW:** Passat (3B3) 2.0 11.01-05.05 96KW 130HP 1984CC, Passat Variant (3B6) 2.0 11.01-05.05 96KW 130HP 1984CC

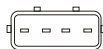

GH5230

REPLACES / REEMPLAZA:

BOSCH: 0 280 217 504, 0 280 217 505; **VW:** 021 906 462; **FORD:** 95VW12B529DA

APPLICATION / APLICACIÓN:

VW: Corrado (53I) 2.9 VR6 08.91-12.95 140KW 190HP 2861CC, Golf II (1H1) 2.8 VR6 01.92-08.97 128KW 174HP 2792CC, Golf II (1H1) 2.9 VR6 Syncro (1Hx1) 10.94-08.97 140KW 190HP 2861CC, Golf II Variant (1H5) 2.9 VR6 Syncro 10.94-04.99 140KW 190HP 2861CC, Vento (1H2) 2.8 VR6 01.92-09.98 128KW 174HP 2792CC, Passat (3A2,35I) 2.8 VR6 06.91-08.96 128KW 174HP 2792CC, Passat Variant (3A5,35I) 2.8 VR6 06.91-05.97 128KW 174HP 2792CC, Passat Variant (3A5,35I) 2.9 VR6 Syncro 01.94-05.97 135KW 184HP 2861CC



GH5231

REPLACES / REEMPLAZA:

BOSCH: 0 280 218 071, 0 280 218 072; **AUDI/VW:** 07C 906 461; **PORSCHE:** 955 606 123 00

APPLICATION / APLICACIÓN:

AUDI: A8 (4D2,4D8) 6.0 W12 quattro 01.01-09.02 309KW 420HP 5998CC; **PORSCHE:** CAYENNE (955) Turbo 4.5 09.02 331KW 450HP 4511CC, CAYENNE (955) Turbo S 4.5 01.04 368KW 500HP 4511CC, CAYENNE (955) Turbo S 4.5 03.06 383KW 521HP 4511CC; **VW:** PHAETON (3D2) 6.0 W12 4 motion 04.02 309KW 420HP 5998CC, GOLF II (1J1) 3.2 R32 4 motion 09.02-06.05 177KW 241HP 3189CC, PHAETON (3D2) 6.0 W12 4 motion 05.05 331KW 450HP 5998CC, NEW BEETLE (9C1,1C1) 2.5 07.05 110KW 150HP 2480CC, NEW BEETLE (1Y7) 2.5 07.05 110KW 150HP 2480CC, JETTA II (1K2) 2.5 FSI 01.06 110KW 150HP 2480CC



GH5244

REPLACES / REEMPLAZA:

GM: 25007539; **ACD:** 213-165; **CARDONE:** 74-7539

APPLICATION / APLICACIÓN:

BUICK: Century 3.8L 1985-1987; **OLDSMOBILE:** Ciera 3.8L 1985-1988



GH5245

REPLACES / REEMPLAZA:

GM: 25007557; **ACD:** 213-167; **CARDONE:** 74-7557

APPLICATION / APLICACIÓN:

CHEVROLET: Camaro 2.8L 1985-1989



GH5246

REPLACES / REEMPLAZA:

ACD: 213-4341; **GM:** 19179714; **HITACHI:** AFH50M-03A; **CARDONE:** 86-50001

APPLICATION / APLICACIÓN:

BUICK: CENTURY w/3 Screw Attachment 1996 6 Cyl 3.1L, CENTURY 1994-95 6 Cyl 3.1L, LESABRE w/3 Screw Attachment 1995-96 6 Cyl 3.8L, LESABRE 1992-94 6 Cyl 3.8L, PARK AVENUE w/o Supercharger-w/3 Screw attachment 1996 6 Cyl 3.8L, PARK AVENUE w/o Supercharger 1991-95 6 Cyl 3.8L, REATTA 1991 6 Cyl 3.8L, REGAL 1991-94 6 Cyl 3.8L, RIVIERA w/o Supercharger 1995 6 Cyl 3.8L, RIVIERA 1991-93 6 Cyl 3.8L; **CHEVROLET:** SUV'S LUNIMA APV 1992-95 6 Cyl 3.8L



GH5247

REPLACES / REEMPLAZA:

APPLICATION / APLICACIÓN:

BUICK: Century w/2 Screw Attachment 1996 3.1L, All 1997-1998 3.8L, LeSabre w/2 screw attachment 1996 3.8L, Park Avenue 1996 3.8L, Riviera (VIN Code 1)/(VIN Code K) w/2 Screw Attachment 1996 3.8L, Regal 1996 3.8L; **CHEVROLET:** Camaro 1998 3.8L, Lumina 1998 3.8L, Monte Carlo 1998 3.8L, Camaro 1996-1997 3.8L; **PONTIAC:** All 1997-1998 3.8L, Bonneville w/2 screw attachment 1996 3.8L, Firebird w/A.T. w/2 screw attachment 1996 3.8L, Firebird w/M.T 1996 3.8L; **OLDSMOBILE:** Cutlass Ciera w/2 screw attachment 1996 3.1L, All 1997-1998 3.8L, Delta 88,98 Regency w/2 screw attachment 1996 3.8L



GH5248

REPLACES / REEMPLAZA:

ACD: 213-4271; **GM:** 94859375; **TOYOTA:** 22204-15010, 197400-2060; **CARDONE:** 86-50010

APPLICATION / APLICACIÓN:

CHEVROLET: Prizm 2000-2002 4Cylinder 1.8L; **TOYOTA:** Corolla 2000-2002 1.8L; **LEXUS:** SC430 2002-2006 4.3L, GS430 2001-2005 4.3L

GH5251



REPLACES / REEMPLAZA:

ACD: 213-3455; **GM:** 19112570; **CARDONE:** 74-7877

APPLICATION / APLICACIÓN:

CHEVROLET: Celebrity 1989 6Cylinder 2.8L; **PONTIAC:** 6000 1987-1989 2.8L, Grand Prix 1988 2.8L; **OLDSMOBILE:** Ciera 1987-1989 2.8L, Cutlass 1988 2.8L

GH5253



REPLACES / REEMPLAZA:

ACD: 213-1585; **GM:** 12579352; **HITACHI:** AFH60M-23A; **CARDONE:** 86-50043

APPLICATION / APLICACIÓN:

CHEVROLET: Malibu 4Cylinder 3.2L 2004-2007

GH5254



REPLACES / REEMPLAZA:

TOYOTA: 22204-21010, 197400-2000; **CARDONE:** 86-20030

APPLICATION / APLICACIÓN:

TOYOTA: Truck 6Cyl 3.0L 1995-1998

GH5256



REPLACES / REEMPLAZA:

NISSAN: 22680-D9003; **HITACHI:** AFHC36605GA3; **CARDONE:** 86-10047

APPLICATION / APLICACIÓN:

NISSAN: Altima 4Cyl 2.4L 1996-1997

GH5257



REPLACES / REEMPLAZA:

NISSAN: 22680-D9002, 22680 D9000; **HITACHI:** AFHC36605GA2; **CARDONE:** 86-10016

APPLICATION / APLICACIÓN:

NISSAN: Altima 4Cyl 2.4L 1994-1995

GH5258



REPLACES / REEMPLAZA:

NISSAN: 22680-9E005; **HITACHI:** AFHC36610GA2; **CARDONE:** 86-10045

APPLICATION / APLICACIÓN:

NISSAN: Altima 4Cyl 2.4L 1998-2001



GH5261

REPLACES / REEMPLAZA:

GM: 25007866, 19112569; **CARDONE:** 74-7866; **AC DELCO:** 213-3454

APPLICATION / APLICACIÓN:

BUICK: Regal Turbo (VIN Code 7) 3.8L 1986-1987



GH5263

REPLACES / REEMPLAZA:

NISSAN: 22680-5J000; **HITACHI:** AFH70-16; **CARDONE:** 86-50014

APPLICATION / APLICACIÓN:

INFINITI: QX4 3.3L 1998-2000; **NISSAN:** Xterra 3.3L 2000-2004, Frontier 3.3L 1999-2004, Quest 3.3L 1999-2002, Pathfinder 3.3L 1998-2000



GH5265

REPLACES / REEMPLAZA:

NISSAN: 22680-4W001; **CARDONE:** 86-10072

APPLICATION / APLICACIÓN:

NISSAN: Trucks Pathfinder 3.5L 2001-2002; **INFINITI:** Trucks QX4 3.5L 2001-2002



GH5266

REPLACES / REEMPLAZA:

NISSAN: 22680-16V00; **CARDONE:** 86-10014

APPLICATION / APLICACIÓN:

NISSAN: Maxima 3.0L 1989; **INFINITI:** M3 3.0L 1990-1992



GH5272

REPLACES / REEMPLAZA:

HYUNDAI: 28164-23200, 9210930002; **CARDONE:** 86-10079

APPLICATION / APLICACIÓN:

HYUNDAI: Elantra 1.8L 1996-1998, Tiburon 1.8L 1997, Tiburon 2.0L 1997-2001, Elantra 2.0L 1999-2000



GH5274

REPLACES / REEMPLAZA:

SUBARU: 22680AA160; **CARDONE:** 86-10034

APPLICATION / APLICACIÓN:

SUBARU: Imperza 1.8L 1993-1997, Legacy 2.0L 1995-1998, Impreza 2.0L 1995-1998, Legacy w/o Turbo 2.2L 1991-1994, Legacy w/A.T 2.2L 1990, Legacy 2.5L 1996-1999, Impreza 2.5L 1998, Forester 2.5L 1998

GH5276

REPLACES / REEMPLAZA:

VDO: 5WK9609; **RENAULT:** 77 00 314 057, 77 00 314 669; **OPEL:** 92 01 701, 45 06 158

APPLICATION / APLICACIÓN:

RENAULT: ESPACE IV (JK0/1_) 2.2 dCi (JK0H) 02/11 110KW 150HP, LAGUNA II (BG0/1_) 2.2 dCi 05/05 102KW 140HP, LAGUNA II (BG0/1_) 2.2 dCi (BG0F) 01/10 110KW 150HP, LAGUNA II Grandtour (KG0/1_) 2.2 dCi 05/05 102KW 140HP, LAGUNA II Grandtour (KG0/1_) 2.2 dCi (KG0F) 01/10 110KW 150HP, MASTER II Box (FD) 2.2 dCi 90 00/09 66KW 90HP, MASTER II Box (FD) 2.5 dCi 120 01/10 84KW 115HP, MASTER II Bus (JD) 2.2 dCi 90 00/09 66KW 90HP, MASTER II Bus (JD) 2.5 dCi 120 01/10 84KW 115HP, MASTER II Platform/Chassis (ED/HD/UD) 2.2 dCi 90 00/09 66KW 90HP, MASTER II Platform/Chassis (ED/HD/UD) 2.5 dCi 120 01/10 84KW 115HP, VEL SATIS (BJ0_) 2.2 dCi (BJ0E, BJ0F) 02/06 110KW 150HP, VEL SATIS (BJ0_) 2.2 dCi (BJ0G, BJ0H) 04/09 102KW 140HP, **OPEL:** MOVANO Box (F9) 1.9 DTI 01/10 60KW 82HP, MOVANO Box (F9) 2.2 DTI 00/09 66KW 90HP, MOVANO Box (F9) 2.5 DTI 01/10 84KW 115HP, MOVANO Combi (J9) 1.9 DTI 01/10 60KW 82HP, MOVANO Combi (J9) 2.2 DTI 00/09 66KW 90HP, MOVANO Combi (J9) 2.5 DTI 01/10 84KW 115HP, MOVANO Dumptruck (H9) 2.2 DTI 00/09 66KW 90HP, MOVANO Platform/Chassis (U9, E9) 2.2 DTI 00/09 66KW 90HP, MOVANO Platform/Chassis (U9, E9) 2.5 DTI 01/10 84KW 115HP



GH5277

REPLACES / REEMPLAZA:

VDO: 5WK96351

APPLICATION / APLICACIÓN:

TOYOTA; SUZUKI



GH5279

REPLACES / REEMPLAZA:

FORD: F37Z12B579RRM, F37F12B579AA, F37F12B579FA, AFLS-190RM

APPLICATION / APLICACIÓN:

FORD: ESCORT 4 Cyl 1.9L 1994-1995, ESCORT 4 Cyl 2.3L 1993-1995, ESCORT 6 Cyl 3.0L 1993-1995, ESCORT 6 Cyl 3.0L 1992, ESCORT 6 Cyl 3.0L 1991; **MAZDA:** B2300 4 Cyl 2.3L 1994, B3000 6 Cyl 3.0L 1994, **MERCURY:** TRACER 4 Cyl 1.9L 1995-94



GH5282

REPLACES / REEMPLAZA:

NISSAN: 22680-AA310, 197400 2090; **CARDONE:** 86-50040

APPLICATION / APLICACIÓN:

SUBARU: Impreza 2.0L 2002-2005, Impreza 2.5L 2005-2006, Trucks Baja w/Turbo 2.5L 2004-2006, Forester 2.5L 2004-2006



GH5284

REPLACES / REEMPLAZA:

HITACHI: AFH55M12; **NISSAN:** 16017 1S710

APPLICATION / APLICACIÓN:

NISSAN: D21 Hardbody Pickup 2.4L 1995-1997, Frontier 2.4L 1998-2004, Xterra 2.4L 2000-2004



GH5285

REPLACES / REEMPLAZA:

HITACHI: AFH45M14, AFH45M15

APPLICATION / APLICACIÓN:

NISSAN: D21 Pick up Truck 2.4L 1986-1989, Pathfinder 2.4L/3.0L 1987-1989, Hardbody Pickup

2.4L 1986-1989



GH5286

REPLACES / REEMPLAZA:
HITACHI: AFH55M10; **CARDONE:** 86-50052
 APPLICATION / APLICACIÓN:
NISSAN: D21 Hardbody Trucks 2.4L 1990-1996



GH5287

REPLACES / REEMPLAZA:
HITACHI: AFH45M46
 APPLICATION / APLICACIÓN:
NISSAN: Sunny III(N14) 1.4L 1990-1995, 100NX(B13) 1.6L 1990-1994, Sentra 1.6L 1991-1994



GH5288

REPLACES / REEMPLAZA:
NISSAN: 22680-1M205; **HITACHI** : AFHC36606BA2
 APPLICATION / APLICACIÓN:
NISSAN: SENTRA 1.6L 1995-1999, 200SX 1.6L 1995-1998



GH5291

REPLACES / REEMPLAZA:
VDO: 5WK97014
 APPLICATION / APLICACIÓN:
LADA



GH5292

REPLACES / REEMPLAZA:
VOLGA: 407282.000
 APPLICATION / APLICACIÓN:
VOLGA



GH5293

REPLACES / REEMPLAZA:
FORD: YC2Z12B579BA, YC2F12B579BA, YC2F12B579AA, 3W7Z12B579BA, 3W7F 12B579-BA
 APPLICATION / APLICACIÓN:
FORD: Mustang w/o Supercharged Eng. 4.6L 2003, Mustang 4.6L 2002, F150 Pickup 4.6L 2003-2005, Explorer 4.6L 2002-2005, E150 Van 4.6L 2000-2003, Excursion/ E150/ E250/ E350 Van 5.4L 2000-2003, F250/ F350 Super Duty Pickup 5.4L 2000-2003, F250 Super Duty Pickup 6.8L 2004, AII 6.8L 2000-2003; **LINCOLN:** Town Car 4.6L 2003-2004, Aviator 4.6L 2003-2005





GH5294

REPLACES / REEMPLAZA:

FORD: F5UZ12B579BA, F5VZ12B579BBRM; **CARDONE:** 86-9525

APPLICATION / APLICACIÓN:

FORD: AEROSTAR 3.0 i V6 108/147 2986 03.86-12.97, BRONCO II 2.9 i V6 4x4 104/141 2935 01.88-08.90, Crown Victoria 4.6L 1995, All 4.9L 1996, All 5.8L 1996-1997; **MERCURY:** Town Car 4.6L 1995, Grand Marquis 4.6L 1996

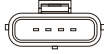

GH5295

REPLACES / REEMPLAZA:

Bosch: 0 281 002 620; **FIAT:** 55 350 047; **OPEL:** 93 178 050

APPLICATION / APLICACIÓN:

OPEL: MERIVA 1.3 CDTI 51/69 1248, MERIVA 1.7 CDTI 74/100 1686; MERIVA 1.7 CDTI 16V 74/100 1686



GH5298

REPLACES / REEMPLAZA:

BOSCH: 0 280 218 220

APPLICATION / APLICACIÓN:

UAZ: 31512 (3151) 2.7 1992/10 ZMZ-409.10



GH5315

REPLACES / REEMPLAZA:

BOSCH: 0 281 002 683, 0 281 002 618; **FIAT:** 11140004, 55183651, 55350048; **OPEL:** 55350048, 93178243; **SUZUKI:** 13800 T7950 001, 13800-79J50, 13800 79J50 000

APPLICATION / APLICACIÓN:

ALFA ROMEO: 156 Sportwagon (932) 1.9 JTD 16V Q4 110/ 150 04/07 - 06/05, 156 Sportwagon (932) 1.9 JTD 110/ 150 05/03 - 06/05; **CHEVROLET:** LACETTI (J200) 2.0 D 89/ 121 07/01, NUBIRA Saloon 2.0 D 89/ 121 05/01, NUBIRA Estate 2.0 D 89/ 121 07/01, CAPTIVA (C100, C140) 2.0 D 4WD 110/ 150 06/10; **FIAT:** IDEA 1.9 JTD 74/ 101 04/01, CROMA (194) 1.9 D Multijet 100/ 136 05/12; **LANCIA:** MUSA (350) 1.9 D Multijet 74/ 101 04/10; **OPEL:** COMBO Box Body / Estate 1.3 CDTI 16V 55/ 75 05/10, VECTRA C 1.9 CDTI 110/ 150 04/04, VECTRA C GTS 1.9 CDTI 110/ 150 04/04, SIGNUM 1.9 CDTI 110/ 150 04/04, COMBO Tour 1.3 CDTI 16V 55/ 75 05/10; **SAAB:** 9-5 (YS3E) 1.9 TiD 110/ 150 06/01, 9-5 Estate (YS3E) 1.9 TiD 129/ 175 07/01, 9-3 (YS3F) 1.9 TiD 110/ 150 04/09; **SUZUKI:** SX4 (GY) 1.9 DDiS 4x4 88/ 120 06/06; **VAUXHALL:** CORSA Mk III (C) (W5L, F08) 1.3 CDTI 16V 55/ 75 05/09 - 06/09



GH5320

REPLACES / REEMPLAZA:

BOSCH: 0 280 218 190; **BENZ:** 273 094 09 48, A 273 094 09 48, 273 094 05 48, A 273 094 05 48, 273 094 06 48, A 273 094 06 48

APPLICATION / APLICACIÓN:

BENZ: E-CLASS Convertible (A207) E 350 CGI (207.457) 215/ 292 10/01, E-CLASS Convertible (A207) E 500 (207.472) 288/ 388 10/01, E-CLASS T-Model (S212) E 350 4-matic (212.287) 200/ 272 09/11, E-CLASS T-Model (S212) E 350 CGI (212.257) 215/ 292 09/11, E-CLASS T-Model (S212) E 500 (212.272) 285/ 388 09/11, E-CLASS T-Model (S212) E 350 (212.256) 200/ 272 09/08, E-CLASS Coupe (C207) E 350 CGI (207.357) 215/ 292 09/01, E-CLASS Coupe (C207) E 500 (207.372) 285/ 388 09/01, E-CLASS (W212) E 350 CGI (212.057) 215/ 292 09/01, E-CLASS (W212) E 350 4-matic (212.087) 200/ 272 09/01, E-CLASS (W212) E 500 (212.072) 285/ 388 09/01, E-CLASS (W212) E 500 4-matic (212.090) 285/ 388 09/01, E-CLASS (W212) E 300 (212.054) 170/ 231 09/01



GH5330

REPLACES / REEMPLAZA:

BOSCH: 0 281 002 980; **FIAT:** 51782034, 55206757; **FORD:** 9S511 2B579 AA, 1542478; **MARUTI:** 13800M55KDO

APPLICATION / APLICACIÓN:

ALFA ROMEO: MITO (955) 1.3 JTDM 70/ 95 09/10; **FIAT:** PUNTO EVO Van 1.3 D Multijet 70/ 95 09/03, GRANDE PUNTO Van (199) 1.3 D Multijet 55/ 75 08/04, 500 C 1.3 D Multijet 55/ 75 09/09; **FORD:** KA 1.3 TDCi 55/ 75 08/10; **LANCIA:** YPSILON (843) 1.3 D Multijet 77/ 105 07/05, MUSA (350) 1.3 D Multijet 66/ 90 06/09





GH5331

REPLACES / REEMPLAZA:

BOSCH: 0 281 002 802, 55558417

APPLICATION / APLICACIÓN:

VAUXHALL: MERIVA 1.3 CDTI 55/ 75 03/09 - 10/05, MERIVA Mk I (A) 1.3 CDTI 55/ 75 03/01 - 09/10



GH5332

REPLACES / REEMPLAZA:

BOSCH: 0 281 002 764; **FIAT:** 55190587, 551905878

APPLICATION / APLICACIÓN:

ALFA ROMEO: BRERA 2.4 JTDM 20V 154/ 210 07/05, SPIDER (939) 2.4 JTDM 154/ 210 08/03; **SAAB:** 9-3 (YS3F) 1.9 TTID 132/ 180 07/12, 9-3 Convertible (YS3F) 1.9 TTID 132/ 180 07/12, 9-3 Estate 1.9 TTID 132/ 180 07/12, 9-3X 1.9 TTID 132/ 180 09/02



GH5336

REPLACES / REEMPLAZA:

BOSCH: 0 281 002 861; **FIAT:** 51782033, 55206756

APPLICATION / APLICACIÓN:

ALFA ROMEO: 159 (939) 1.9 JTDM 8V 88/ 120 05/09 - 11/11, 159 (939) 1.9 JTDM 16V 110/ 150 05/09 - 11/11, 159 Sportwagon (939) 1.9 JTDM 8V 88/ 120 06/03 - 11/11, 159 Sportwagon (939) 1.9 JTDM 16V 110/ 150 06/03 - 11/11; **FIAT:** DOBLO (119) 1.9 JTD (223AXE1A) 74/ 100 01/10, DOBLO (119) 1.9 JTD 77/ 105 03/07, DOBLO (119) 1.9 D Multijet 88/ 120 05/10, DOBLO Cargo (223) 1.9 JTD (223ZXE1A) 74/ 100 01/10, DOBLO Cargo (223) 1.9 JTD 77/ 105 03/07, DOBLO Cargo (223) 1.9 JTD Multijet 88/ 120 06/12, IDEA 1.9 JTD 74/ 101 04/01, PUNTO / GRANDE PUNTO (199) 1.9 D Multijet 96/ 130 05/10



GH5337

REPLACES / REEMPLAZA:

BOSCH: 0 281 002 792; **FIAT:** 55183650

APPLICATION / APLICACIÓN:

FIAT: LINEA (323) 1.3 D Multijet 66/ 90 07/06, BRAVO II (198) 1.9 D Multijet 88/ 120 07/04, PUNTO / GRANDE PUNTO (199) 1.3 D Multijet 66/ 90 05/10, PANDA Van (169) 1.3 JTD 55/ 75 06/01, PANDA Van (169) 1.3 Multijet 4x4 55/ 75 06/01; **LANCIA:** MUSA (350) 1.3 D Multijet 66/ 90 06/09, YPSILON (843) 1.3 D Multijet 77/ 105 07/05; **ALFA ROMEO:** GT (937) 1.9 JTD 110/ 150 03/11, 147 (937) 1.9 JTDM 16V 110/ 150 05/07



GH5342

REPLACES / REEMPLAZA:

BOSCH: 0 281 006 048; **FIAT:** 51827033; **IVECO:** 69503670

APPLICATION / APLICACIÓN:

ALFA ROMEO: 159 (939) 2.4 JTDM 154/ 210 07/05 - 11/11, 159 (939) 2.4 JTDM Q4 154/ 210 07/05 - 11/11, 159 Sportwagon (939) 2.4 JTDM 154/ 210 07/05 - 11/11, 159 Sportwagon (939) 2.4 JTDM Q4 154/ 210 07/05 - 11/11; **FIAT:** DUCATO Bus (250) 120 Multijet 2,3 D 88/ 120 06/07, DUCATO Bus (250) 160 Multijet 3,0 D 116/ 158 06/07, DUCATO Box (250) 120 Multijet 2,3 D 88/ 120 10/03, DUCATO Box (250) 130 Multijet 2,3 D 96/ 131 07/01, DUCATO Box (250) 160 Multijet 3,0 D 116/ 158 06/07, DUCATO Platform/Chassis (250) 120 Multijet 2,3 D 88/ 120 10/03, DUCATO Platform/Chassis (250) 130 Multijet 2,3 D 96/ 131 07/01, DUCATO Platform/Chassis (250) 160 Multijet 3,0 D 116/ 158 06/07; **LANCIA:** THESIS (841AX) 2.4 D Multijet 136/ 185 06/04; **IVECO:** MASSIF Station Wagon 3.0 HPI 130/ 176 08/10, MASSIF Pickup 3.0 HPI 130/ 176 08/10



GH5344

REPLACES / REEMPLAZA:

FORD: F48Z12B579AARM, F48F12B579AA; **HITACHI:** AFH70-04A; **CARDONE:** 86-9517

APPLICATION / APLICACIÓN:

FORD: Trucks Windstar 3.8L 1995-1995





GH5345

REPLACES / REEMPLAZA:
 VDO: 5WK97023; VW: 03L 906 461
 APPLICATION / APLICACIÓN:
 -



GH5348

REPLACES / REEMPLAZA:
FORD: F37F-12B579-DA, F37Z-12B579-D, F37Z-12B579-DARM; **CARDONE:** 74-9513
 APPLICATION / APLICACIÓN:
FORD: Trucks Aerostar 3.0L 1995-1993, Trucks Ranger 1995-1992; **MAZDA:** Trucks B3000 1994-1994



GH5349

REPLACES / REEMPLAZA:
FORD: F57F-12B579-AA, F57Z-12B579-A, F57Z-12B579-ABRM, F57Z-12B579-AARM, 4032926; **CARDONE:** 74-9520
 APPLICATION / APLICACIÓN:
FORD: Trucks Explorer 1995-1995, Trucks Explorer 4.0L 1995-1995



GH5350

REPLACES / REEMPLAZA:
FORD: E9SF-12B579-AA, E9SZ-12B579-A, E9SZ-12B579-AARM; **HITACHI:** AFH55-03A; **CARDONE:** 74-9501
 APPLICATION / APLICACIÓN:
FORD: Cougar (Mexico) 1990-1990, Thunderbird 1990-1989; **MERCURY:** Cougar 1990-1989



GH5352

REPLACES / REEMPLAZA:
FORD: F1SF12B579-AA, F1SZ-12B579-A, F1SZ-12B579-AARM; **HITACHI:** AFH70-02; **CARDONE:** 74-9509
 APPLICATION / APLICACIÓN:
FORD: Mustang 5.0L 1993-1991, Thunderbird 3.8L 1995-1991



GH5353

REPLACES / REEMPLAZA:
 VDO: 5WK9 7917;
MERCEDES BENZ: A 651 090 01 48
 APPLICATION / APLICACIÓN:
 ...



GH5354

REPLACES / REEMPLAZA:

VDO: 5WK97008Z;
RENAULT: 82 00 280 060;
GM: 93 856 812;
OPEL: 4416861

APPLICATION / APLICACIÓN:

RENAULT: Megane II (BM0/1_ , CM0/1_) 1.5 dCi 05/05 78KW 106HP 1461CLC, Scénic II (JM0/1_) 1.5 dCi (JM1F) 05/05 63KW 86HP 1461CC, Scénic II (JM0/1_) 1.5 dCi (JM1E) 05/05 78KW 106HP 1461CC, Megane II Coupé-Cabriolet (EM0/1_) 1.5 dCi (EM1E) 06/03 78KW 106HP 1461CC, Megane II Saloon (LM0/1_) 1.5 dCi 05/05 63KW 86HP 1461CC, Megane II Saloon (LM0/1_) 1.5 dCi 05/05 78KW 106HP 1461CC, Megane II Estate (KM0/1_) 1.5 dCi 05/05 63KW 86HP 1461CC, Kangoo (KW0/1_) 1.5 dCi (KW0B) 08/02 63KW 86HP 1461CC, Kangoo (KW0/1_) 1.5 dCi (KW0C, KW0F) 08/02 76KW 103HP 1461CC, Kangoo Express (FW0/1_) 1.5 dCi 85 (FW0A, FW0B) 08/02 63KW 86HP 1461CC, Kangoo Express (FW0/1_) 1.5 dCi (FW0F) 08/02 76KW 103HP 1461CC, Kangoo BE BOP (KW0/1_) 1.5 dCi (KW0F) 09/02 76KW 103HP 1461CC;
OPEL: Movano Box (F9) 2.5 CDTI 03/10 88KW 120HP 2464CC, Movano Combi (J9) 2.5 CDTI 06/08 88KW 120HP 2464CC, Vivaro Combi (J7) 2.0 16V 01/08 88KW 120HP 1998CC, Vivaro Combi (J7) 2.0 CDTI 06/08 66KW 90HP 1995CC



GH5355

REPLACES / REEMPLAZA:

VDO: 5WK97012Z;
GM: 93185443;
OPEL: 55353813, 836 647, 08 36 647

APPLICATION / APLICACIÓN:

OPEL: Astra H 1.8 06/01103KW 140HP 1796CC, Astra H Estate 1.8 05/08 103KW 140HP 1796CC, Astra H GTC 1.8 06/01 103KW 140HP 1796CC, Astra H TwinTop 1.8 05/09 103KW 140HP 1796CC, Signum 1.8 05/09 103KW 140HP 1796CC, Vectra C 1.8 06/01 103KW 140HP 1796CC, Vectra C GTS 1.8 06/01 103KW 140HP 1796CC, Vectra C Estate 1.8 06/01 103KW 140HP 1796CC, Zafira (A05) 1.8 05/07 103KW 140HP 1796CC



GH5682

REPLACES / REEMPLAZA:

BOSCH: 0 280 218 254;
GM: 13301682;
 Meat & Doria: 86296

APPLICATION / APLICACIÓN:

GM: Aveo Hatchback 2011>, Cruze 2009>, Cruze Hatchback 2010>, Cruze Station Wagon 2012>, Orlando 2010>, Volt 2011>
OPEL: Adam 2012>, Ampera 2011>, Astra J 2009>, Astra J GTC 2011>, Astra J Sports Tourer 2010>, Astra K 2015>, Astra K Sport Tourer 2015>, Cascada 2013>, Corsa D, Corsa D Van 2006>, Corsa E, Corsa E Van 2014>, Meriva B 2010>, Zafira Tourer C 2011>
VAUXHALL: Zafira Mk III 2011>



GH5791 // NEW //

REPLACES / REEMPLAZA:

GM: 15865791, 12576410, 25940911; **BREMI:** 30254; **TRANSPO:** MAF10142

APPLICATION / APLICACIÓN:

GM: HHR 2.4 2005>2011 Petrol;
CADILLAC: SRX 4.6 AWD 2003>2009, STS 3.6 / 4.4 / 4.6, XLR 4.4 2004>2009;
HUMMER: H3 5.3 V8 AWD 2008>;
OPEL: Astra J GTC 2011>, Insignia Hatch 2008>2017, Insignia Saloon 2008>2017, Insignia A Sports Tourer 2008>2017;
SAAB: 9-3 Saloon 2002>2015, 9-3 Cabrio 2003>2015, 9-3 Estate 2005>2015, 9-3X 2009>2015, 9-5 2010>2012, 9-7X 2004>2012



GH5980 // NEW //

REPLACES / REEMPLAZA:

DENSO: 197400-5220;
HONDA: 37980-RLF-003, 37980-R11-A01, 37980-R11-WZZ, 37980-R40-AA0, 37980-R40-A01

APPLICATION / APLICACIÓN:

HONDA: Civic X Hatchback 1.5 VTEC 2017>, Accord Mk8 saloon 2.4i 2008>2015, Accord Mk8 saloon 2.4i 2008>



EMS COMPONENTS | SISTEMA DE CONTROL DE MOTOR

MAP SENSOR | SENSOR MAP

BOSCH
GI3011

REPLACES / REEMPLAZA:
BOSCH: 0 261 230 011
 APPLICATION / APLICACIÓN:
VW: Gol, GII 1.0Mi 8V 98-05, GIII 1.0Mi 99-01

BOSCH
GI3012 // NEW //

REPLACES / REEMPLAZA:
BOSCH: 0 261 230 012; **Peugeot:** 1920.0E/1920
 APPLICATION / APLICACIÓN:
Citroën: Berlingo 1.8/2.0, Xsara 1.4/1.6/1.8/2.0; **Peugeot:** 206 98>05, 306 97>07, 406 2.0, 605 97>99

BOSCH
GI3013

REPLACES / REEMPLAZA:
BOSCH: 0 261 230 013
 APPLICATION / APLICACIÓN:
GM: Ipanema 2.0 MPFI 96-97, Kadett 2.0 MPFI 96-98 /GSi 2.0 91-95, Vectra 2.0 MPFI 96-98 /2.0 SFI 16V 96-97;
HYUNDAI: Accent 1.5i 16V /1.5i Hatchbac 95-99, Excel 1.5i 16V /1.5i Hatchback 95-99.

BOSCH
GI3020

REPLACES / REEMPLAZA:
BOSCH: 0 261 230 057; **CITROËN/ PEUGEOT:** 1920AN
 APPLICATION / APLICACIÓN:
CITROËN: C5 1.8 16V, 2.0 16V 01-04;
 Berlingo 1.4, 1.8 96-02, Xantia 97-01, Xsara 1.4 e 2.0 98-, Picasso 1.6, 1.8, 2.0 00-;
PEUGEOT: 206 1.4, 1.6, 1.8, 2.0, 2.0 16V 96-07, 306 97-03, 307 2.0i 00-05, 406 99-04, Partner 1.4, 1.8 96-02 Fiat Scudo 2.0 00-07

BOSCH
GI3022

REPLACES / REEMPLAZA:
BOSCH: 0 261 230 022
 APPLICATION / APLICACIÓN:
GM: Astra, Zafira, Blazer, S10 2.2 /2.4, Vectra 2.2 /232 16V

BOSCH
GI3030

REPLACES / REEMPLAZA:
BOSCH: 0 261 230 030, 0 261 230 174; **CHEVROLET:** 12568929, 93313154; **FIAT:** 7084986, 46553045
 APPLICATION / APLICACIÓN:
FIAT: Palio, Siena, Strada, Weekend, Uno, 1.0 /1.3 /1.4 /1.8 /Flex, Stilo, Punto, Idea 1.4 /1.8 /Flex.
CHEVROLET: Blazer 4.3 V6 MPFI gasolina 2001>2003, Celta 1.0 VHCE Flexpower 2009>, Classic 1.0 VHCE Flexpower 2008>2010, Corsa 1.0 VHC Flexpower 2005>2008, Corsa 1.0 VHCE Flexpower 2008>2009, Corsa 1.4 Econo.Flex 2007>, Corsa 1.8 MPFI Flexpower 2005>, Meriva 1.4 Econo.Flex 2008>, Meriva 1.8 MPFI Flexpower 2005>, Montana 1.4 Econo.Flex 2007>2009, Montana 1.8 MPFI Flexpower 2005>2007, Montana Combo 1.4 Econo.Flex 2007>2010, Prisma 1.0 VHCE Flexpower 2009>2011, Prisma 1.4 Econo.Flex 2006>2009, S10 4.3 V6 MPFI gasolina 2001>2003

BOSCH
GI3031

REPLACES / REEMPLAZA:
VW: 06B 906 051; **Bosch:** 0 261 230 031
 APPLICATION / APLICACIÓN:
VW: Gol II, III 1.0 8V MI 99/05, Golf IV, V 2.0 8V 02 / 07 / 1.6 Plus 05-, Parati II SPECIAL 1.0 8V MI 99/02, Parati III 1.0 8V MI 01/05, Passat 2.0 16V 05/, Polo 1.0 98-01 / 1.6 / 2.0 03;
AUDI: A3 1.6 03;
GM: Kadett 2.0 MPFI 97/

BOSCH
GI3037

REPLACES / REEMPLAZA:

BOSCH: 0 261 230 037

APPLICATION / APLICACIÓN:

VW: Gol III 1.0Mi 16V Turbo 00>03, Parati III 1.0Mi 16V Turbo 00>04, Kombi 1.6Mi 97>05

BOSCH
GI3044

REPLACES / REEMPLAZA:

BOSCH: 0 261 230 044

APPLICATION / APLICACIÓN:

FORD: EcoSport 2.0 16V Duratec 03>08, Focus 2.0 16V Duratec 05>08

BOSCH
GI3052

REPLACES / REEMPLAZA:

BOSCH: 0 261 230 095; **VW:** 03C 906 051

APPLICATION / APLICACIÓN:

VW: Bora 2.0, Fox, Space Fox, Gol, Parati GIII 1.6, Golf, Polo 1.6 /1.8, Saveiro 1.6 /1.8 /2.0

BOSCH
GI3079

REPLACES / REEMPLAZA:

BOSCH: 0 261 230 027; **Ford:** XS6F 9FA79 AA, XS6F 97479 AB

APPLICATION / APLICACIÓN:

FORD: Courier, Ka, 1.0, 1.6 Zetec Rocam 99/, Ecosport, Focus 1.6L Zetec Rocam 03/, Escort 1.0, 1.6 Zetec Rocam 00/02, Fiesta 1.0, 1.6 Zetec Rocam 02/

BOSCH
GI3099

REPLACES / REEMPLAZA:

BOSCH: 0 261 230 099

APPLICATION / APLICACIÓN:

GM: Astra 2.0 MPFI Flexp 2004> /2.4 GSI SFI 16 2003> / 2.4 SFI 16V 2003> / Sedan 2.0 MPFI 2004> / Sedan 2.4 SFI 2003>, Blazer 2.4 MPFI Flex 2007>, S10 2.4 MPFI Flexpow 2007>, Vectra 2.0 Flexpower 2005>, Vectra 2.4 16V Flexp 2005> / Hatch 2.0 Fle 2007>, Zafira 2.0 MPFI Flex 2004>;

HONDA: Fit 1.4i 8V 2003>, Jazz 1.2 /1.4 2002>.

BOSCH
GI3130

REPLACES / REEMPLAZA:

CITROËN: 96393830; **PEUGEOT:** 1920 AJ, 4676 80

APPLICATION / APLICACIÓN:

CITROËN: Berlingo 1.1, 1.4, 1.6 16V 96/, C2 1.1, 1.4, 1.6 03/, C3 1.1, 1.4 16V, 1.6 16V 02/, C4 1.4 16V, 1.6 16V, 2.0 16V 04/, C5 1.8 16V, 2.0 16V 04/, C8 2.0 16V 05/, Expert, 2.0 16V 07/, Saxo 1.1, 1.4, 1.6 96/, Xsara 1.4, 1.6 16V 00/05, Xsara Picasso 1.6 16V 05/;

PEUGEOT: 106 1.1 96/, 206 1.1, 1.4 16V, 1.6 16V 98/, 207 1.4, 1.4 16V, 1.6 16V 06/, 306 1.4, 1.6 93/, 1.6 16V 94/, 307 1.4,1.4 16V,1.6 16V, 2.0 16V 00/, 407 1.8,1.8 16V, 2.0 16V, 2.2 16V 04/, 1007 1.4, 1.4 16V, 1.6 16V 05/, Partner 1.4, 1.6 16V 01/

BOSCH
GI3146

REPLACES / REEMPLAZA:

BOSCH: 0 261 230 146, 0 261 230 289

GM/ OPEL: 12591290, 12644228, 55573248

APPLICATION / APLICACIÓN:

GM: Aveo Hatch/Saloon 1.4 2008->, Aveo Hatchback/Saloon 1.2/1.4/1.6 2011->, Camaro 6.2 2009>2015, Camaro Convertible 6.2 2011->, Captiva 2.4/3.0 2010->, Cruze 1.4/1.6 2010->, Cruze Hatchback/ Station Wagon 1.4/1.6 2012->, Malibu 2.4 2012->, Orlando 1.4 2012->, Spark 1.0/1.2 2010->, Trax 1.6 2012->, Volt EV 150 2011->

OPEL: Adam 1.3/1.4 2012->, Ampera EV 150 2011->, Astra G Estate 1.6 16V 1998>2004, Astra H Hatch/Estate 1.6 2004>2010, Astra J 1.4/1.4 Turbo/1.6/1.6 Turbo 2009->, Astra J Saloon 1.4/1.4 Turbo/1.6/1.6 Turbo 2012->, Astra J GTC 1.4/1.6/1.8 2011->, Astra J Sport Tourer 1.4/1.4 Turbo/1.6/1.6 Turbo 2010->, Antara 2.4/3.0 2010->, Corsa D Hatch 1.0/1.2/1.4/1.6 Turbo 2007->, Corsa D Van 1.0/1.2 2006->, Corsa E 1.2/1.4/1.6 Turbo 2014->, Corsa E Van 1.2/1.4 2014->, Insignia Hatch/Saloon/Estate 1.6/1.6 Turbo/1.8 2008->, Meriva B 1.4 2010->, Mokka 1.6 2012->, Zafira A MPV 1.6 16V 1999>2005, Zafira Tourer 1.4/1.8 2011->

BOSCH
GI3189

REPLACES / REEMPLAZA:

PEUGEOT: 1920 AC, 4574 03, 4574 05; **Renault:** 96 39 418 980; **Citroën:** 96394189

APPLICATION / APLICACIÓN:

CITROËN: C4 2.0 16V 04/, C5 1.8 16V, 2.0 16V, 3.0 V6 01/, C8 2.0, 3.0 V6 02/, SAXO 1.6 VTS 16V 96/, Xsara 2.0 16V 00/, Xsara Picasso 1.8, 2.0 16V 00/;
PEUGEOT: 106 1.6 S16 16V 96/, 206 2.0 S16 16V 00/, 307 2.0, 2.0 16V 00/, 406 3.0 V6 24V 00/, 407 1.8 16V, 2.0 16V, 3.0 24V 04/, 607 2.0, 3.0 V6 24V 00/, 807 2.0, 3.0 V6 02/;

RENAULT: Avantime 3.0 V6 24V 01/03, Clio II 3.0 V6 Sport 24V 00/05, Laguna II 3.0 V6 24V 01/

BOSCH
GI3224 // NEW //

REPLACES / REEMPLAZA:

BOSCH: 0 261 230 224, 0 261 230 131; **FORD:** M9101473, 1503280, 6C119 F479 AB

APPLICATION / APLICACIÓN:

FORD: Transit (MK7) 2006>2014

BOSCH
GI3316 // NEW //

FEATURES / CARACTERÍSTICAS: VOLTAGE: 0,5>4,5V | PRESSURE / PRESIÓN: 50>400kPa

REPLACES / REEMPLAZA:

BOSCH: 0 281 002 316; **FORD:** BG5X 9D290 AA; **MEAT & DORIA:** 82588

APPLICATION / APLICACIÓN:

DAF: XF95 2002>2006, XF105 2005->, CF65/75/85 2001>2013, FL45/55 2001->

IVECO: EuroCargo I-III 1991>2015

NEW HOLLAND: TS-A 2003>2006

RENAULT TRUCKS: Premium 1996->, Kerax 1997->, Midlum 2000->, Midliner 1982>2000

BOSCH
GI3334

FEATURES / CARACTERÍSTICAS: VOLTAGE: 0,40>4,65 V | PRESSURE: 10>115kPa

REPLACES / REEMPLAZA:

BOSCH: 0 261 230 334, 0 261 230 333;

FOMOCO: CV2A-9F479-AA

APPLICATION / APLICACIÓN:

FORD: Fiesta MK7 1.0 2012>, Focus 2.0 2012>, Focus Turnier 2.0 2012>, Kuga 1.6 Ecoboost 2013>

BOSCH
GI3437 // NEW //

FEATURES / CARACTERÍSTICAS: VOLTAGE: 0,40>4,65 V | PRESSURE: 20>300kPa

REPLACES / REEMPLAZA:

BOSCH: 0 281 002 437, 0 281 002 845; **OPEL:** 9158595, 9196671, 93171176; **VOLKSWAGEN:** 2R0 906 051 C; **TRANSPON:** MAP2118; **MEAT & DORIA:** 82143

APPLICATION / APLICACIÓN:

OPEL: Astra G Hatch/Saloon/Estate 2.2 DTI 1998>2009, Astra G Coupe/Convertible 2.2 DTI 2000>2005, Astra H Hatch/Saloon/GTC Hatch/Estate/Box 1.3 CDTI / 1.9 CDTI 16v 2004>2014, Signum 1.9 CDTI 2003>, Vectra C Saloon/GTS Hatch/Estate 1.9 CDTI 2002>, Zafira A Mpv 2.2 DTI 16V 1999>2005, Zafira B MPV 1.9 CDTI 2005>

VOLKSWAGEN: Volksbus 8.150 EOD/9.150 OD/9.150 EOD/15.190 EOD/17.230 EOD/17.260 EOT 2005>

BOSCH
GI3514

FEATURES / CARACTERÍSTICAS: VOLTAGE: 0,2>4,8 V | PRESSURE: 20>250kPa

REPLACES / REEMPLAZA:

BOSCH: 0 281 002 514; **Fiat:** 500351377; **Iveco:** 500351377; **VW:** 2P0 906 051

APPLICATION / APLICACIÓN:

FIAT: Ducato Minibus/Van 2.3/2.8 2002>, Ducato Flatbed 2.3/2.8 2002>2006;

IVECO: Daily III Box Body/Estate 1999>2006, Daily III Bus 1999>2006, Daily III Platform/ Chassis 1998>2009;

VW: Volksbus 5.140 EOD 2005>

BOSCH



GI3576

REPLACES / REEMPLAZA:

BOSCH: 0 281 002 576; **Volvo:** 20524936; **Renault Trucks:** 5010437653; **Kamaz:** 201149033; **Iveco:** 504073323, 501073323

APPLICATION / APLICACIÓN:

GAZ: Sadko 3308/3309 1997>

KAMAZ: 6 6520 2003>

MAZ: Serie 100 1034 1996>

RENAULT TRUCKS: Magnum 1990>, Premium 1996>, Kerax 1997>, Midlum 2000>

VOLVO: FE 240-18/240-22/240-26/260-18/260-26/280-18/280-26/ 300-18/300-26/320-18/320-22/340-18/340-26 2006>, FE II 2012>, FH 2005>, FH12 1993>, FH16 1993>, FH16 II 2009>, FL II 2006>, FL III 2013>, FM 2005>, FM9 2001>2005, FM12 1998>2005, FMX 2010>, B9 2002>, 7700 2006>, 9700 2001>, 9900 2001>

IVECO: Stralis AD 440S31 / AT 440S31 2003

BOSCH



GI3593 // NEW //

FEATURES / CARACTERÍSTICAS: VOLTAGE: 0.2>4,8 V | PRESSURE: 20>250kPa

REPLACES / REEMPLAZA:

BOSCH: 0 281 002 593; **DACIA:** 223657266R; **OPEL:** 93450122; **RENAULT:** 223657266R, 8200225971; **TRANSPO:** MAP2119; **MEAT & DORIA:** 82244

APPLICATION / APLICACIÓN:

DACIA: Duster 1.5 dCi 2010>, Logan Saloon 1.5 dCi 2005>, Logan MCV Estate 1.5 dCi 2007>, Logan Express 1.5 dCi 2009>, Logan Pickup 1.5 dCi 2008>, Sandero Hatch 1.5 dCi 2008>

NISSAN: Interstar Minibus/Van dCi 80 2002>, Primastar Van dCi 80 2001>

OPEL: Vivaro Minibus/Van/Flatbed 1.9 DI/1.9 DTI 2001>

RENAULT: Clio Mk2 Hatch 1.5 dCi/1.9 dTi 1999>, Clio Mk2 Van 1.5 dCi 2001>, Clio Mk3 Hatch 1.5 dCi 2005>, Kangoo Mk1 1.5 dCi 2001>, Kangoo Mk1 Van 1.5 dCi/1.9 dTi 2000>, Logan I/II Estate 1.5 dCi 2007>, Megane Mk1 Hatch/Mk1 Estate/Mk1 Coupe/Classic Saloon 1.9 dTi/1.9 dCi 2001>2003, Modus Hatch 1.5 dCi 2004>, Scenic Mk1 Re-Style MPV 1.9 dTi/1.9 dCi 1999>2003, Thalia I 1.5 dCi 2002>, Thalia II 1.5 dCi 08>, Twingo Mk2 Hatch 1.5 dCi 2007>, Trafic Mk3 Minibus/Van/Flatbed 1.9 dCi 80/100 2001>

CITROËN/PEUGEOT



GI3980 // NEW //

REPLACES / REEMPLAZA:

CITROËN/ PEUGEOT: 9670361980; **VALEO:** 255610

APPLICATION / APLICACIÓN:

CITROËN: C1 1.2 >2014, C3 1.0/1.2 2012>2016, C3 Picasso 1.2 2015, C3 Aircross 1.2 2017, C4 1.2 2014>2015, C4 Picasso 1.2 2014>2016, C4 Cactus 1.2 2014, Ds3 1.2 2013.2015, Ds3 Cabriolet 2013>2015;

PEUGEOT: 108 1.2 2014, 208 1.0/1.2 2012>2013, 301 1.2 2012>2014, 308 1.2 2013, 2008 1.2 2013>2018, 3008 1.2 2015>2016, 1.2 2015>2017, Partner 1.2 2016

DELPHI



GI3060

REPLACES / REEMPLAZA:

GM: 16212460; **Renault:** 77 00 106 644; **Daewoo:** 93160018

APPLICATION / APLICACIÓN:

GM: Astra 1.6 16V MPFI 03/, Celta 1.0, 1.4 MPFI 01/02, Corsa / Meriva 1.8 16V MPFI 03/;

DAEWOO: Leganza, 2.0, 2.2 16V 97/02, Nubira 2.0 16V 97/00, Rezzo 2.0 8V/16V 00/, Tacuma 2.0 00/05/;

PEUGEOT: 206 1.0 16V Todos/;

RENAULT: Clio 1.0 16V Todos, Kangoo 1.0 Todos, Laguna 1.6 16V 97/01, Mégane 1.4 99/, Twingo 1.2 8V 07/

CHRYSLER



GI3158 // NEW //

FEATURES / CARACTERÍSTICAS: VOLTAGE: 0,3>4,8 V | PRESSURE: 15>105kPa

REPLACES / REEMPLAZA:

CHRYSLER: 56041018AB, 68002763AA; **STANDARD:** AS158; **MEAT & DORIA:** 82336; **TRANSPO:** MAP158

APPLICATION / APLICACIÓN:

CHRYSLER: Town & Country 2001, Voyager Mk3 3.3 2000>2008

DODGE: Caravan 3.3 2000>2007, Dakota 2002, Durango 2002, Grand Caravan 2001, Ram 1500 2002, Ram 1500 Van 2002, Ram 2500 Van 2002, Ram 3500 Van 2002

JEEP: Grand Cherokee 4.7 V8 4X4 1999>2005, Liberty 2002, TJ 2003, Wrangler Mk2 2.4 2002>2007

DELPHI



GI3069

REPLACES / REEMPLAZA:

DELPHI: SPD 00169

APPLICATION / APLICACIÓN:

GM: Monza 1.8 /2.0 91 em diante EFI, Kadet /Ipanema, 1.8 /2.0 91 em diante EFI, Corsa /Hatch /Pick up /Sedan, 1.0 /1.4 /1.6 EFI /MPFI 94 em diante, S10, Blazer, 2.2 96 em diante EFI, Omega /Suprema 2.2 96 em diante MPFI, Vectra 2.2 97 em diante MPFI, Lumina 3.1 /3.4 91 em diante.

DELCO
GI3350

REPLACES / REEMPLAZA:
GM: 93 333 350

APPLICATION / APLICACIÓN:
GM: Astra 2.0 (MPFI) 02>, Celta, Corsa 1.0 e 1.4 VHC (Flexpower) 02>, Meriva 1.8 8V 02>, Meriva 1.8 16V 02>, Montana 1.4 (Econo.Flex) e 1.8 (MPFI) 02>, Prisma 1.4 (Econo.Flex) 08>

DENSO
GI3035 // NEW //

FEATURES / CARACTERÍSTICAS:
REPLACES / REEMPLAZA:
Mitsubishi: 079800-7790, 1865A035

Meat & Doria: 82571

APPLICATION / APLICACIÓN:
MITSUBISHI: Shogun/Pajero Mk3 3.2 DI-D 2007>, L-200 2.5 DI-D 2005>

DENSO
GI3250 // NEW //

FEATURES / CARACTERÍSTICAS:
REPLACES / REEMPLAZA:
DENSO: 079800-4250; **HONDA:** 37830PAAS00, 37830POGS00, 37830P05A01, 37830P7AN11; **LAND-ROVER:** MHK100590

APPLICATION / APLICACIÓN:
Honda: ACCORD V CE, CF 2.2 1995>1998, ACCORD VI Hatchback CH, CL 2.3 2000>2002, ACCORD VI CK, CG, CH, CF 2.3 1999>2003, CIVIC V Sedan EG, EH 1.6 EX 16V 1991>1995, CR-V I RD 2.0 ELX 16V 4WD RD1, RD3 1999>2002, CRX III EH, EG 1.6 VTI 16V EG2 1992>1998, PRELUDE V BB 2.2 SI 16V BB6, BB8 1996>2000 **LAND ROVER:** 400 Schrägheck (RT) 1995>2000

GM
GI3988

FEATURES / CARACTERÍSTICAS: VOLTAGE: 0,5>4,5V | PRESSURE: 10>115kPA

REPLACES / REEMPLAZA:
GM: 55575988, 55575988CA

APPLICATION / APLICACIÓN:
GM: Onix 1.0/1.4 4Cil 8V Flex 13>15, Prisma 1.0/1.4 4Cil 8V Flex 13>15

HYUNDAI
GI3005 // NEW //

FEATURES / CARACTERÍSTICAS:
REPLACES / REEMPLAZA:
HYUNDAI/ KIA: 39300-2B020, 39300-2B000; **MTE:** 71077

APPLICATION / APLICACIÓN:
HYUNDAI: Accent 1.6 4Cyl 16v Gasoline 2012>2014 Azera 3.3 V6 24v Gasoline 2012>2015 Elantra 1.8 4Cyl 16v Gasoline 2010>2015 Elantra 2.0 4Cyl 16v Flex 2010>15 Equus 5.0 V8 32v Gasoline 2012>2014 Genesis 5.0 V8 32v Gasoline 2012>2014 HB20 1.0 3Cyl 12v Flex 2012>16 HB20 1.6 4Cyl 16v Flex 2012>16 IX35 2.0 4Cyl 16v Gasoline 2009> IX35 2.0 4Cyl 16v Flex 2012> IX35 2.4 4Cyl 16v Gasoline 2009> Santa Fé 2.4 4Cyl 16v Gasoline 2010>2014 Santa Fé 3.3 V6 24v Gasoline 2013>2014 Sonata 2.0 4Cyl 16v Gasoline 2008 >2014 Sonata 2.4 4Cyl 16v Gasoline >2008 Sonata 2.4 4Cyl 16v Híbrido - Gasoline/Eléctrico 2011>2014 Sonata 3.3 V6 24v Gasoline 2006>2010 Tucson 2.0 4Cyl 16v Gasoline 2010>2014 Tucson 2.4 4Cyl 16v Gasoline 2014 Veloster 1.6 4Cyl 16v Gasoline 2012>2014 KIA: Cadenza 3.3 V6 24v Gasoline 2014> Cerato 1.6 4Cyl 16v Flex 2009>2014 Optima 2.0 4Cyl 16v Gasoline 2011>2014 Optima 2.4 4Cyl 16v Gasoline 2009>2013 Optima 2.4 4Cyl 16v Híbrido - Gasoline/Eléctrico 2011>2014 Picanto 1.0 3Cyl 12v Flex 2011> Sorento 2.4 4Cyl 16v Gasoline 2011>2014 Sorento 3.3 V6 24v Gasoline 2014 Soul 1.6 4Cyl 16v Flex 2010>2014 Soul 1.6 4Cyl 16v Gasoline 2010>2014 Sportage 2.0 4Cyl 16v Gasoline >2014 Sportage 2.0 4Cyl 16v Flex >2014 Sportage 2.4 4Cyl 16v Gasoline 2011>2014

HYUNDAI
GI3200 // NEW //

FEATURES / CARACTERÍSTICAS: VOLTAGE: 0,4>4,5V | PRESSURE: 10>115kPA

REPLACES / REEMPLAZA:
HYUNDAI/ KIA: 39300-38200, 9480930201

MEAT & DORIA: 82344

APPLICATION / APLICACIÓN:
HYUNDAI: Grandeur 3.3 2005>2010, Santa Fé 2.4 16V 4x4 2001>2006, Santa Fé 2.7 V6 4x4 2006>2009, Sonata Mk3 2.4 16V 1998>2001, Sonata Mk5 3.3 2005>2010, Terracan 3.5 V6 2001>2006, XG 30 1998>2005, XG 350 2002>2005

KIA: Sedona Mk3 2.7 V6 2006->, Opirus 3.5 2003->, Opirus 3.8 V6 2006->, Sorento Mk1 2.4 2002->, Sorento Mk1 3.5 V6 2002->

JAC
GI3506 // NEW //

FEATURES / CARACTERÍSTICAS:
REPLACES / REEMPLAZA:
JAC: 28082506

APPLICATION / APLICACIÓN:
JAC: J2/ J31.4 16V

MAGNETI MARELLI GI3092



REPLACES / REEMPLAZA:

Magneti Marelli: T-PRT05/A; **Fiat:** 46451792, 70114218, 71718233, 71718678, 71728656

APPLICATION / APLICACIÓN:

FIAT: Brava 1.6 16V 96/01, Doblò / Stilo 1.6 16V 01/, Fiorino 1.5 MPI 98/, Marea 1.6 16V 00/, Palio 1.0, 1.5, 1.6 MPI 99/, 1.6 16V 98/, Palio Young / Siena 1.0 MPI FIRE. 01/, Siena 1.0, 1.5, 1.6 MPI 99/01, Strada 1.6 16V MPI 02/, 1.5, 1.6 MPI 99/01, Uno 1.0, 1.5 MPI 99/.

MAGNETI MARELLI GI3151



REPLACES / REEMPLAZA:

Magneti Marelli: 502.024.02, T-PRT04; **Bosch:** F 000 99P 402; **VW:** 036 906 051, 027 998 041 1, 036 906 051 D, 036 998 041 1, 36 906 051 D, 036 998 041 1

APPLICATION / APLICACIÓN:

VW: Bora 1.4 16V, 1.6 16V 00/, Gol 1.0 MI AT 16V 97/, Gol / Parati / Saveiro 1.6, 1.8, 2.0 MPI 97/, Golf III 1.6 92/97, Golf IV 1.6 16V 00/, Parati 1.0 MI AT 16V 97/02, Polo 1.4 16V, 1.6 16V GTI 99/01, Polo Classic 1.8 MPI 96/, Quantum / Santana 1.8, 2.0 MPI 96/;

SEAT: Arosa, Inca 1.4 16V 00/, Cordoba 1.4 16V, 1.6 00/, Ibiza III 1.4 16V, 1.6 99/02, Leon, Toledo II 1.4 16V, 1.6 16V 99/

MAGNETI MARELLI GI3002



REPLACES / REEMPLAZA:

Magneti Marelli: 502.011.02

APPLICATION / APLICACIÓN:

FIAT: Palio /Siena /Strada, 8V SPi /1.6 16V MPI 96-00, Uno /Premio /Elba 8V SPi 92-01, MPI 97-02, Fiorino 8V SPi 94-96 /MPI 97-02, Ducato 2.8 Diesel 99-00. Turbo 01-05, Tipo 2.0 MPI 94-95, Tempra, 2.0 93-99, Brava, 00-03, Coupe 16V 95-97;

VW: Gol /Parati AP 2.0 16V 95-00.

MERCEDES BENZ GI3028 // NEW //



REPLACES / REEMPLAZA:

Mercedes Benz: A 004 153 7028, 004 153 70 28; **BOSCH:** 0 281 002 468; **Meat & Doria:** 82585

APPLICATION / APLICACIÓN:

MERCEDES: Actros 2531,2535 1996>2002, Citaro N 1999, NG 2000

SIEMENS GI3493 // NEW //



REPLACES / REEMPLAZA:

Siemens: 5WK9684; **Cummins:** 4076493, 2T2 906 051 B, 23B 906 051 A

APPLICATION / APLICACIÓN:

FORD: F250, F350, F4000; **VW:** 19.320, 17.330, 24.320, 25.390, 31.330

SIEMENS GI3762



REPLACES / REEMPLAZA:

Siemens/ VDO: 8200719629, 7700101762, 5WK96814; **Renault:** 7.700.101.762, 8.200.105.165, 8.200.121.800; **Peugeot:** 1920CW;

APPLICATION / APLICACIÓN:

RENAULT: Clio, Kangoo, Twingo 1.0 16V (Todos), Megane, Scenic 1.6 16V (Todos), Megane, Scenic 2.0 16V (Todos).

TOYOTA**GI3171 // NEW //**

REPLACES / REEMPLAZA:

Toyota: 8942171020

APPLICATION / APLICACIÓN:

TOYOTA: Hilux Vi Pick-Up 2.5 D-4D 2001>2005, Hilux Vi Pick-Up 2.5 D-4D 4Wd 2001>2005, Hilux Vii Pick-Up 2.5 D 4Wd 2005>2015, Hilux Vii Pick-Up 2.5 D-4D 2005>2015, Hilux Vii Pick-Up 2.5 D-4D 4Wd 2004>2005, Land Cruiser Prado 3.0 D-4D 2002>2010, Yaris 1.4 D-4D 2005>2012

TOYOTA**GI3894 // NEW //**

REPLACES / REEMPLAZA:

Toyota: 8942171030; **DENSO:** DAP-0113

APPLICATION / APLICACIÓN:

LEXUS: IS II 200D, 220D 2005>2012;

TOYOTA: Auris 2006>2018, Avensis 2003>2008, Corolla 2006>2019, Corolla Verso 2004>2009, IQ 2008>2015, Land Cruiser 200 2007



EMS COMPONENTS | SISTEMA DE CONTROL DE MOTOR

DPF SENSOR | SENSOR DPF

BOSCH
GS4528

REPLACES / REEMPLAZA:
Bosch: 0 281 002 925; **Mercedes:** A 006 153 9528

APPLICATION / APLICACIÓN:
SMART: Fortwo/Fortwo Cabrio 0.8 Cdi 09>, Forfour 1.5 Cdi 04>06;

JEEP: Wrangler Mk3 2.8 CRD 07>;

MERCEDES BENZ: A-CLASS 04>12, B-CLASS 05>11, C-CLASS SALOON 00>14, C-CLASS ESTATE 01>07, C-CLASS COUPE 01>, CLC-CLASS COUPE 08>11, CLK-CLASS 02>09, CLK-CLASS CONVERTIBLE 03>10, CLS-CLASS 04>11, CLS 11>, CLS Shooting Brake 12>, E-CLASS SALOON 02>09, E-CLASS ESTATE 03>, E-CLASS 09>, E-CLASS Coupe 09>, E-CLASS Convertible 10>, S-CLASS SALOON 05>13, SLK 11>, M-CLASS 05>11, R-CLASS 06>, G-CLASS/G-CLASS CABRIO 89>, GL-CLASS 06>, GLK-CLASS 08>, VIANO 03>, VITO MINIBUS/VITO VAN 03>, SPRINTER 3-T MINIBUS/3-T VAN/3-T FLATBED/3,5-T MINIBUS/3,5-T VAN/3,5 FLATBED/4,6-t Box/4,6-t Platform/Chassis/5-T VAN/5-T FLATBED 06>

CITROËN
GS4200 // NEW //

REPLACES / REEMPLAZA:
Citroën/ Peugeot: 1606610880 FORD: AB39-5L224-AA, AV21-5H209-AB, 6G9N-5L200-AB, 8V21-5H209-CD; **Volvo:** 30785486, 30785486-AA; **Mazda:** Y64518215A, Y64518215B, Y66018215A; **Meat & Doria:** 82557

APPLICATION / APLICACIÓN:
SMART: Fortwo/Fortwo Cabrio 0.8 Cdi 09>, Forfour 1.5 Cdi 04>06;

JEEP: Wrangler Mk3 2.8 CRD 07>;

MERCEDES BENZ: A-CLASS 04>12, B-CLASS 05>11, C-CLASS SALOON 00>14, C-CLASS ESTATE 01>07, C-CLASS COUPE 01>, CLC-CLASS COUPE 08>11, CLK-CLASS 02>09, CLK-CLASS CONVERTIBLE 03>10, CLS-CLASS 04>11, CLS 11>, CLS Shooting Brake 12>, E-CLASS SALOON 02>09, E-CLASS ESTATE 03>, E-CLASS 09>, E-CLASS Coupe 09>, E-CLASS Convertible 10>, S-CLASS SALOON 05>13, SLK 11>, M-CLASS 05>11, R-CLASS 06>, G-CLASS/G-CLASS CABRIO 89>, GL-CLASS 06>, GLK-CLASS 08>, VIANO 03>, VITO MINIBUS/VITO VAN 03>, SPRINTER 3-T MINIBUS/3-T VAN/3-T FLATBED/3,5-T MINIBUS/3,5-T VAN/3,5

FIAT
GS4304 // NEW //

REPLACES / REEMPLAZA:
Fiat: 55210304

APPLICATION / APLICACIÓN:
FIAT: Ducato 110/120/130/150/160/180 Multijet 2.3 D 2006->, Scudo Mk1 Estate/Van 2.0 JTD 16V 1999>2006, Scudo Mk2 MPV/Van/Flatbed 1.6/2.0 D Multijet 2007->, Ulysses 2.0 JTD/2.0 D Multijet/2.2 JTD/2.2 D Multijet 2002>2011;

LANCIA: Phedra 2.0 JTD 2002>2010

VW
GS4051

REPLACES / REEMPLAZA:
VW: 076.906.051.B

APPLICATION / APLICACIÓN:
AUDI: A3 Mk2 Hatch 3-Door/5-Door/Convertible 1.6 TDI 09>13, Q3 2.0 TDI/2.0 TDI quattro 11>, TT Coupe Mk2/TT Roadster Cabrio Mk2 2.0 TDI quattro 08>14;

SEAT: Alhambra 2.0 TDI/2.0 TDI 4Drive 10>, Altea MPV 1.6 TDI/2.0 TDI 06>, Altea XL MPV 1.6 TDI/2.0 TDI 4x4 07>, Leon Mk2 Hatch 1.6 TDI/2.0 TDI 06>12;

SKODA: Fabia Mk2 Hatch/Estate 1.4 TDI/1.9 TDI 07>10, Octavia Mk2 Hatch/Estate 1.6 TDI/1.6 TDI 4x4/2.0 TDI RS 06>13, Roomster MPV 1.4 TDI/1.9 TDI 06>10, Praktik Van 1.4 TDI 07>10, Superb Mk2/Estate 1.6 TDI/2.0 TDI/2.0 TDI 4x4 08>15, Yeti 1.6 TDI/2.0 TDI/2.0 TDI 4x4 09>;

VW: Amarok 2.0 TDI/2.0 TDI 4Motion/2.0 BitDI/2.0 BitDI 4Motion 10>, Beetle/Beetle Convertible 1.6 TDI/2.0 TDI 11>, Caddy III Estate/Caddy Mk3 Van 1.6 TDI 10>15, Caddy IV Estate/Box 1.6 TDI 15>, Golf VI 1.6 TDI/2.0 TDI 08>13, Golf VI Variant 1.6 TDI/1.6 TDI 4Motion 09>13, Golf VI Convertible 1.6 TDI 11>, Jetta Mk3 Saloon 1.6 TDI/2.0 TDI 05>10, Jetta IV 1.6 TDI/2.0 TDI 11>, Passat Mk6 Saloon/Estate 1.6 TDI/2.0 TDI/2.0 TDI 16V/2.0 TDI 16V 4Motion/2.0 Blue TDI/2.0 TDI 4Motion 05>10, Passat Alltrack 2.0 TDI/2.0 TDI 4Motion 12>14, Passat CC Saloon 2.0 TDI/2.0 TDI 4Motion/2.0 Blue TDI 08>12, CC 2.0 TDI/2.0 TDI 4Motion 11>, Passat/Passat Variant 1.6 TDI/2.0 TDI/2.0 TDI 4Motion 10>14, Scirocco Mk3 Coupe 2.0 TDI 09>, Sharan 2.0 TDI/2.0 TDI 4Motion 10>, Tiguan 2.0 TDI/2.0 TDI 4Motion 07>, Touran 1.6 TDI 10>15, Crafter 30-35 Minibus 2.0 TDI/2.0 TDI 4Motion 11>, Crafter 30-50 Van 2.0 TDI/2.0 TDI 4Motion 11>, Crafter 30-50 Flatbed 2.0 TDI/2.0 TDI 4Motion 11>, Transporter T6 Bus/T6 Box/T6 Plataforma/Chassis 2.0 TDI/2.0 TDI 4Motion 15>, Transporter T5 Minibus 2.0/2.0 TDI/2.0 TDI 4Motion/2.0 BitDI/2.0 BitDI 4Motion 03>, Transporter T5 Van/Flatbed 2.0 TDI/2.0 TDI 4Motion/2.0 BitDI/2.0 BitDI 4Motion 09>



EMS COMPONENTS | SISTEMA DE CONTROL DE MOTOR

CRANKSHAFT P. SENSOR | SENSOR DE P. DE ÁRBOL DE LEVAS

GS8000 // NEW //



REPLACES / REEMPLAZA:

VW: 050906433; **Audi:** 050906433; **Valeo:** 254161; **Meat & Doria:** 87063; **Mobiletron:** CS-E309

APPLICATION / APLICACIÓN:

AUDI: 80 (89, 89Q, 8A, B3) 1.6 1996>2002, 80 (8C2, B4) 1.6 E 1995>2002, 80 Avant (8C5, B4) 1.6 E 1995>2002, A4 (8D2, B5) 1.6 1995>2002, A4 (8D2, B5) 1.8 1996>2002, A4 (8D2, B5) 1.8 T 1995>2002, A4 (8D2, B5) 1.8 T Quattro 1995>2002, A4 (8D2, B5) 1.8 T Quattro 1997>2002, A4 (8D2, B5) 1.8 Quattro 1996>2002, A4 Avant (8D5, B5) 1.6 1996>2002, A4 Avant (8D5, B5) 1.8 1996>2002, A4 Avant (8D5, B5) 1.8 T 1996>2002, A4 Avant (8D5, B5) 1.8 T 1998>2003, A4 Avant (8D5, B5) 1.8 T Quattro 2005>2015, A4 Avant (8D5, B5) 1.8 T Quattro 1989>1991, A4 Avant (8D5, B5) 1.8 Quattro 1989>1991, A6 (4B2, C5) 1.8 T 1990>2001, A6 (4B2, C5) 1.8 T 1990>2001, A6 (4B2, C5) 1.8 T Quattro 1990>2002, A6 (4B2, C5) 1.8 T Quattro 1990>2003, A6 Avant (4B5, C5) 1.8 T 1990>2004, A6 Avant (4B5, C5) 1.8 T 1990>2005, A6 Avant (4B5, C5) 1.8 T Quattro 1990>2006, A6 Avant (4B5, C5) 1.8 T Quattro 1990>2007, Cabriolet (8G7, B4) 1.8 1990>2008;

VW: Passat (3B2) 1.6 1996>2000, Passat (3B2) 1.8 1997>2000, Passat (3B2) 1.8 1996>2000, Passat (3B2) 1.8 Syncro/4Motion 1996>2000, Passat (3B2) 1.8 T 1996>2000, Passat Variant (3B5) 1.6 1997>2000, Passat Variant (3B5) 1.8 1997>2000, Passat Variant (3B5) 1.8 Syncro/4Motion 1997>2000, Passat Variant (3B5) 1.8 T 1997>2000

GS8003 // NEW //



REPLACES / REEMPLAZA:

Honda: 37500-PNA-003, 37500-PNB-003, 15503L23

Denso: 15512225

APPLICATION / APLICACIÓN:

Honda: Civic Mk1 Saloon 1.3 1980>1983, Civic Mk6 Hatch 2.0 i Sport/2.0 Type-R 2001>2005, Civic Mk6 Saloon 1.3 IMA 2003>2005, Civic Mk7 Hatch Type-R 2006->, Civic Mk7 Saloon 1.3 Hybrid 2006->, CR-V Mk2 SUV 2.0 2001>2006, FR-V 2.0 2005->, Jazz Mk2 Hatch 1.3 2002>2008, Stream MPV 2.0 16V 2001->

GS8009



REPLACES / REEMPLAZA:

Hafei: 25346094

APPLICATION / APLICACIÓN:

Hafei: Minyz

GS8010



REPLACES / REEMPLAZA:

Hyundai / Kia: 39310-39010

APPLICATION / APLICACIÓN:

Hyundai: XG300, XG350

Kia: Sedona

GS8011 // NEW //



REPLACES / REEMPLAZA:

Meat & Doria: 87710; **Mobiletron:** CS-J105; **NGK:** 81466; **Maxauto:** MAX 08.0165

APPLICATION / APLICACIÓN:

TOYOTA: AVENSIS 1.6/1.8 1997>2000, AVENSIS Liftback 1.6/1.8 1997>2000, AVENSIS Kombi 1.6/1.8 1997>2000, CARINA E 1.6 1993>1997, CARINA E Stufenheck 1.6 1995>1997, CARINA E Sportswagon 1.6 1995>1997, CELICA Coupe 1.8 1993>1999, COROLLA Compact 1.6 1992>1997, COROLLA Liftback 1.6 1992>1997, COROLLA 1.6 1994>1997, COROLLA Kombi 1.6/1.8 1992>1997, COROLLA Compact 1.6 1997>2000, COROLLA Liftback 1.6 1997>2000, COROLLA 1.6 1997>2000, 1.6 1997>2000, COROLLA Kombi 1.6/1.8 1997>2001

GS8013



REPLACES / REEMPLAZA:

Bosch: 0.261.210.207, 0.261.210.208;

VW: 06A906433K, 030906433K

APPLICATION / APLICACIÓN:

VW: Gol III (Power) 1.0 16V MI 2000> Gol, Parati III 1.0 16V MI (TURBO/ASPIRATE) 04/00>02, Gol, Parati, Saveiro 1.6, 1.8 (Flex) 02>Gol II **Special** 1.0Mi 8V 02>05, Touareg, Touran 2002>, Golf 2003>, Passat 2005>;

Audi: A3 2003>



GS8015

REPLACES / REEMPLAZA:

Honda: 37500-PLC-015; **Denso:** 00601D0

APPLICATION / APLICACIÓN:

Honda: Civic 1.7 2001>2005, Acura 2001>2003



GS8030 // NEW //

REPLACES / REEMPLAZA:

Mobiletron: CS-J083; **MTE-THOMSON:** 70568; **NGK:** 81269; **Meat & Doria:** 87711

APPLICATION / APLICACIÓN:

TOYOTA: AURIS 1.4 2007.2012, AVENSIS 1.6/1.8 2000>2008, AVENSIS Liftback 1.6/1.8 2000>2003, AVENSIS Kombi 1.6/1.8 2000>2003, AVENSIS Stufenheck 1.6/1.8 2003>2008, CELICA Coupe 1.8 16v 1999>2005, COROLLA Compact 1.4/1.6 1999>2002, COROLLA Liftback 1.4/1.6 1999>2002, COROLLA 1.4/1.6 1999>2001, COROLLA Kombi 1.4/1.6 16v 2000>2001, COROLLA Stufenheck 1.6 2001.2008, COROLLA Verso 1.6/1.8 2001>2004, MR 2 III 1.8 16v 1999>2007, RAV 4 II 1.8 2000>2005



GS8033 // NEW //

REPLACES / REEMPLAZA:

Nissan: 23731-EC01A, 949979-033

APPLICATION / APLICACIÓN:

Nissan: Almera Mk2 Hatch/Saloon/Tino MPV 2.2 dCi 2003->, Murano 2.5 dCi 4x4 2010>2014, Pick Up 2.5 Di/2.5 Di 4WD 2002>2005, NP300 Pick Up 2.5 dCi/2.5 dCi 4x4 2008->, Primera Mk3 Hatch/Estate 2.2 Di/2.2 dCi 2002->, X-Trail 2.2 dCi/2.2 dCi 4x4 2003>2013



GS8047 // NEW //

REPLACES / REEMPLAZA:

Toyota: 90919-05047, 90919-05067

APPLICATION / APLICACIÓN:

TOYOTA: Avenis Mk1 Saloon/Hatch/Estate 2.0 2000>2003, Avenis Verso MPV 2.0 2001>2009, Avenis Mk2 Hatch/Estate 2.0/2.4 2003>2008, Camry Saloon 2.4 2001>2006, Picnic 2.0 2001, Previa Mk2 2.4 2000>2006, RAV4 Mk2 2.0 2000>2005, RAV 4 Mk3 2.0/2.4 2005->



GS8050

REPLACES / REEMPLAZA:

Hyundai: 39310-38050; **Kia:** 39310-38050;

Mitsubishi: J5T23071A; **Volvo:** 30874179; **Mazda:** MD 327107

APPLICATION / APLICACIÓN:

Hyundai: Santa Fé 2.4 2001>, Sonata 1999>, Atos 1998>;

Kia: Sorento, Picanto, Optima 2001>, Magentis 2001>;

Suzuki: Vitara 1.6, 2.0 1999>;

GM: Tracker 1.6, 2.0 1999>;

Volvo: S40, V40 1995-2003



GS8072

REPLACES / REEMPLAZA:

Mazda: J5T15072, KL4718221

APPLICATION / APLICACIÓN:

Mazda: Millenia



GS8082

REPLACES / REEMPLAZA:

Mazda: ZZM367082, 1F2367082

Ford: F57E6C315CA, F57Z6C315A, 1L5E6C315AA, 1L5Z6C315AA

APPLICATION / APLICACIÓN:

Mazda: B2300, B2500

Ford: Ranger



GS8094

REPLACES / REEMPLAZA:
Chevrolet: 12623094
APPLICATION / APLICACIÓN:
Chevrolet: Camaro, Corvette



GS8099

REPLACES / REEMPLAZA:
Dodge: 5093101AA, 5179099AA, 5179099AB
APPLICATION / APLICACIÓN:
Dodge: Ram Pick up 2500/3500



GS8104

REPLACES / REEMPLAZA:
Fiat: 7762252, 7762282; **Bosch:** 0.261.210104;
Kia: 0K9A018891; **VDO:** 324003030R; **Hyundai:** 3965042110
APPLICATION / APLICACIÓN:
Fiat: Palio, Strada, Siena, Weekend 1.4, 1.6 mpi 96>02, Punto 1.4 93>99;
Hyundai: H200 Diesel, H1 Starex 97>04;
Kia: Sportage Gasoline 84>03, Diesel 97>03, Retona 1998>, Clarus 1996>



GS8126

REPLACES / REEMPLAZA:
Nissan: 237313S500
APPLICATION / APLICACIÓN:
Nissan: Pick up 2.4i 2002>2005



GS8128

REPLACES / REEMPLAZA:
Jeep: 4638128, 53006154, 53009954, 56027042, 56027070
APPLICATION / APLICACIÓN:
Jeep: Cherokee 2.5 / 4.0 1991>2001



GS8145

REPLACES / REEMPLAZA:
Mitsubishi: MR985145, J5T35171
APPLICATION / APLICACIÓN:
Mitsubishi: Shogun/Pajero Mk3 3.8 V6 2007>



GS8150

REPLACES / REEMPLAZA:
Hyundai / Kia: 3918037150, 3918037200
APPLICATION / APLICACIÓN:
Hyundai: Santa Fé, Sonata, Tucson, Trajet
Kia: Sportage, Magentis



GS8151 // NEW //

REPLACES / REEMPLAZA:

Bosch: 0 261 210 151, 0 281 002 662, 0 281 002 742; **Chrysler:** 05066 833AB, 5066 833AB; **Opel:** 09118368, 90532619, 9118368; **Volvo:** 20513343; **GM:** 6238109, 90532619, 9118368; **Renault:** 5010 412 449; **Meat & Doria:** 87206; **Mobiletron:** CS-E001

APPLICATION / APLICACIÓN:

CHRYSLER: Voyager MK 3 2.5/2.8 2000>2008;

NISSAN: Interstar MINIBUS DCI 140 2003, Interstar VAN DCI 140 2003, Interstar FLATBED DCI 140;

SUZUKI: WAGON R 1.2 2004>2005



GS8161

REPLACES / REEMPLAZA:

GM: 10456161; **Delphi:** SS10213

APPLICATION / APLICACIÓN:

GM: Omega Australiano 3.8 V6 98>, Impala, Monte Carlo 1998>2005;

Buick: Lacrosse 2005>2009, Lucerne 2006>2008



GS8170

REPLACES / REEMPLAZA:

Mercedes Benz: 0031532828, 0031532728;

Chrysler: 05080350AA, 05080352AA; **Mitsubishi:** MN-960274, MN-960372

APPLICATION / APLICACIÓN:

Mercedes: Classe A - A160, A190, Classe C - C230, C240, C240 automatic, C280, C32AMG, C320, C320 4matic, C43AMG, Classe 500 - CL500, CL55AMG, CL600, CLK320, CLK430, Classe E - E430, E500, E55AMG, Classe ML - ML320, ML350, ML430, ML500, Classe S - S430, S500, S600, SL500, SL55amg, SL600, SLK230, SLK32amg, SLK320



GS8171

REPLACES / REEMPLAZA:

Mitsubishi: MR560132; **Denso:** J5T20171

APPLICATION / APLICACIÓN:

Mitsubishi: Pajero TR4 2.0, Pajero iO 1.8, Lancer 99>07, Mirage 96>02



GS8178

REPLACES / REEMPLAZA:

Bosch: 0 261 210 178; **VW:** 078906433B

APPLICATION / APLICACIÓN:

AUDI: A4 2.4 Avant quattro 1998>2001 / 2.8 1998>2000 / 2.8 Avant quattro 1999>2001 / 3.0 Avant quattro Cabriolet 2001>2004, A6 2.4 Avant quattro 1997>2005 / 2.8 Avant quattro 1998>2001 / 3.0 2001>2004, TT 1.8 T Coupé quattro 2002>2006 / 1.8 T Roadster quattro 2002>2006 (All Gasoline);

VW: Golf IV 2.0 2007>2008, New Beetle 2.0 2006>2010, Passat 2.8 1997>2005 / 2.8 Variant Syncro 1998>2000 (All Gasoline)

SKODA: Octavia MK 1.6/1.8/2.0 1997>2010, Superb 2.8 V6 2001>2008;

SEAT: Leon 1.8 T Cupra R 2002>2006



GS8180

REPLACES / REEMPLAZA:

Peugeot: 9640316180

APPLICATION / APLICACIÓN:

PEUGEOT: 206 1.0 16V



GS8200 // NEW //

REPLACES / REEMPLAZA:

Hyundai: 39180-25200, 39180-25300

APPLICATION / APLICACIÓN:

Hyundai: iX35 2.0/2.0 4WD 2010->, Santa Fé 2.4/2.4 4x4 1200>2012, Sonata Mk5 2.0 VVTi GLS/2.4 2005>2010

Kia: Carens Mk3 2.0 CVVT 2006->, Sportage 2.0 CVVT 2010->, Magentis Mk2 Saloon 2.0 2005->



GS8202

REPLACES / REEMPLAZA:

Nissan: 23731-6N20A, 23731-6N20B, 23731-6N20C, 23731-6N20D, 23731-6N202, 23731-6N205, 23731-6N206, 23731-6N21A, 23731-8J005, 23731-8J006

APPLICATION / APLICACIÓN:

Nissan: Primera, X-trail, Altima, Frontier, Sentra

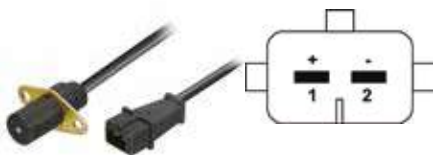

GS8206

cable length: 46cm

REPLACES / REEMPLAZA:

Magneti Marelli: 4820083010; **Fiat:** 4460206

APPLICATION / APLICACIÓN:

FIAT: Elba CSL 4P 1.6 8V (SPI - gasoline) 94>96 / Weekend 2P/4P 1.5 8V (SPI - alcohol/gasoline) 92>96, Fiorino / Furgão/ Pick-up 2P 1.0 8V (SPI - gasoline) 96 / Furgão/ Pick-up 2P 1.3 8V (SPI - gasoline) 94>95 / Furgão 2P 1.5 8V (SPI - alcohol/gasoline) 94>96 / Pick-up 2P 1.5 8V (SPI - alcohol/gasoline) 94>95 / Pick-up LX 2P 1.6 8V (SPI - gasoline) 94>96 / Pick-up Trekking 2P 1.5 8V (SPI - gasoline) 96 / 2P 1.5 8V (MPI - gasoline) 97>98 / MTV 2P 1.5 8V (MPI - gasoline) 97 / Pick-up Working 2P 1.5 8V (SPI - gasoline) 96, Prêmio CS 4P 1.5 8V (SPI - alcohol/gasoline) 93>94 / CSL 4P 1.6 8V (SPI - gasoline) 94>96 / S 2P 1.5 8V (SPI - gasoline) 92>93 / SL 4P 1.5 8V (SPI - gasoline) 92, Uno CS 2P/4P 1.5 8V (SPI - alcohol/gasoline) 93>94 / Furgoneta 2P 1.5 8V (SPI - alcohol/gasoline) 94>96 / Mille City 4P 1.0 8V (SPI - gasoline) 99>00 / Eletronic 2P/4P 1.3 8V (SPI - gasoline) 93>95 / ELX 2P/4P 1.3 8V (SPI - gasoline) 94>95 / EP 2P/4P 1.0 8V (SPI - gasoline) 96 / EX 2P/4P 1.0 8V (SPI - gasoline) 98>00 / IE 2P 1.0 8V (SPI - gasoline) 94 / Smart 2P/4P 1.0 8V (SPI - gasoline) 00>01 / Smart City 4P 1.0 8V (SPI - gasoline) 00>01 / SX 2P/4P 1.0 8V (SPI - gasoline) 97>98 / SX Young 2P 1.0 8V (SPI - gasoline) 98>99, Uno S 2P 1.5 8V (SPI - alcohol/gasoline) 92>94



GS8208

REPLACES / REEMPLAZA:

Chevrolet: 12598208, 12591007

APPLICATION / APLICACIÓN:

Chevrolet: Equinox, Impala, Malibu, Monte Carlo

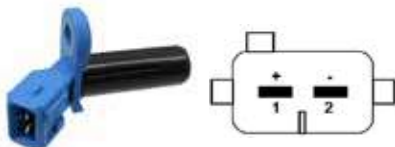

GS8215

REPLACES / REEMPLAZA:

VDO: 324 005 001R

APPLICATION / APLICACIÓN:

FORD: Courier, Fiesta, Ka 1.0/1.3 (Endura) 96>99, EcoSport, Novo Fiesta 1.6 (Zetec RoCam) 03>09



GS8220

REPLACES / REEMPLAZA:

Nissan / Infiniti: 237311S700

APPLICATION / APLICACIÓN:

Nissan: Pick up 2.4i, Pathfinder

Infiniti: QX4 3.3

GS8221



REPLACES / REEMPLAZA:
Ford: 6M866C315
 APPLICATION / APLICACIÓN:
Ford: C-Max, Edge

GS8228



REPLACES / REEMPLAZA:
Opel: 1238228, 6238377, 90506103, 9174621
 APPLICATION / APLICACIÓN:
Opel: Astra, Calibra, Omega, Vectra

GS8235



REPLACES / REEMPLAZA:
Daewoo: 96183235
 APPLICATION / APLICACIÓN:
Daewoo: Lanos hatch/saloon, Nubira hatch/saloon/estate

GS8243 // NEW //



REPLACES / REEMPLAZA:
GM: 55567243; **Valeo:** 366506; **Mobiletron:** CS-E324; **Bremi:** 60293
 APPLICATION / APLICACIÓN:
GM: Aveo 1.6 2011>, Cruze 1.8 2009>, Trax 1.4 2012>, Trax 1.8 2013>

GS8251



cable length: 42cm

REPLACES / REEMPLAZA:
Bosch: 0 281 002 102; **Fiat:** 77662510
 APPLICATION / APLICACIÓN:

FIAT: Brava 1.4 12V 94>98, Coupé 2.0 20V 94>98, Marea Turbo 98>07, Marea Weekend ELX 4P 2.0i 20V (MPI - gasoline) 142 CV 96>00, Marea, Marea Weekend HLX 4P 2.0i 20V (MPI - gasoline) 142 CV 96>00

GS8269



* Right side output.

REPLACES / REEMPLAZA:
Renault: 7700101970, 7700103069A; **Bosch:** 0 986 280 410
 APPLICATION / APLICACIÓN:

RENAULT: Clio II 1.6i / 1.6i 16V 1999 / 2007, Twingo 1.0 16V, Kangoo 1.6i 2001 >, Mégane 1.6i / 2.0 1996 / 2002, Mégane II 1.6i 16V, Scénic I / II 1.6 16V 1999 >



GS8282

REPLACES / REEMPLAZA:

Mitsubishi: J5T23282 / ME203180

APPLICATION / APLICACIÓN:

Mitsubishi: Pajero III 3.2 Di-D 2000>2006, Pajero III 3.2 Di-D 2000>2001



GS8290

cable length: 48,5cm

REPLACES / REEMPLAZA:

Magneti Marelli: 4820084010; **Fiat:** 5944390, 7588435, 7604582, 7646975

APPLICATION / APLICACIÓN:

FIAT: Ducato TD 2.8 8V (MPI - gasoline) 00>, Tempra 2.0 16V (MPI - gasoline) 93>99, Tempra 2.0 8V (SPI - gasoline) 94>, Uno Turbo 1.4 8V (MPI - gasoline) 94

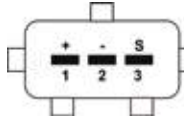

GS8302

cable length: 73,5cm

* without air conditioning

REPLACES / REEMPLAZA:

Bosch: 0 261 210 102, 0 261 210 115; **Fiat:** 7756925, 7799033; **New Holland:** 8203048

APPLICATION / APLICACIÓN:

FIAT: Tipo 2P/4P 1.6 8V (SPI - gasoline), Tempra 1.6ie 1993 / 1996

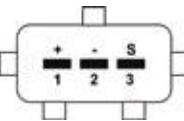

GS8303

cable length: 64cm

REPLACES / REEMPLAZA:

Bosch: 0 261 210 103, 0 261 210 118; **Fiat:** 7756924, 7799032

APPLICATION / APLICACIÓN:

FIAT: Elba CSL 1.6 (MPI) All, Fiorino, Pick-up 1.6 (MPI) 95>96, Tempra 1.6ie 04/93>12/96, Tipo 1.6 ie (gasoline) with AC 93>95, Tipo 1.6 8V (MPI - gasoline) with AC 96>97, Uno 1.6 8V (MPI - gasoline) 95>96



GS8305

REPLACES / REEMPLAZA:

Ford: 94BF-6C315-AA, 948F-6C315-AA, 92BF-6C315-A1F, 928F-6C315-A1F, F5RZC315AA; **Mazda:** 1E00-18-221, YF0918221

APPLICATION / APLICACIÓN:

Ford: Escort 91>, Fiesta 1.0, 1.4 95>, Focus 98>04, KA 1.3 96>08, Mondeo 96>00, Transit 00>06;

Mazda: Model 121 III 96>



GS8307 // NEW //

REPLACES / REEMPLAZA:

Fiat: 5033307AC

APPLICATION / APLICACIÓN:

Jeep: Compass 2.0 16V 2011>

Dodge: Caliber 1.8/2.0/2.4 2006->, Viper Convertible SRT-10 2002>2006

Lancia: Flavia Convertible 2.4 2012>2014



GS8311 // NEW //

REPLACES / REEMPLAZA:

Mazda: L3G218221, L3K918221A; **Bremi:** 60172; **Meat & Doria:** 87581; **Mobiletron:** CS-J046

APPLICATION / APLICACIÓN:

Mazda: 3 hatch/saloon 2.0/2.3 2003>2009, 5 MPV, 6 saloon/estate/sport 1.8/2.0 2002>2007, MX-5 Mk3 1.8/2.0 2005>2014

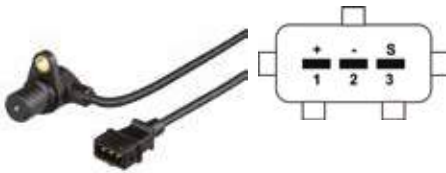

GS8315

cable length: 99cm

REPLACES / REEMPLAZA:

Bosch: 0 261 210 030; **GM:** 90 213 515, 90 451 441; **VDO:** 324 003 007R

APPLICATION / APLICACIÓN:

GM: Astra, Sedan 2.0 (MPFI) 09/94>12/96, Astra 2.0i 09/91>02/98, Astra, Sedan 2.0 (MPFI) 09/03>, Astra, Sedan 2.0 (MPFI - Flexpower) 04/04>, Blazer, S10 2.2 (MPFI) 08/97>04/00, Blazer, S10 2.4 (MPFI) 05/00>01/07, Calibra 2.0i/2.0i turbo 06/90>03/97, Calibra 2.0 16V 10/93>03/96, Omega, Suprema GLS 2.0 (MPFI) 09/92>12/95, Omega 1.8/1.8i/2.0i 09/86>03/94, Vectra 1.8i 03/90>08/95, Vectra CD 2.0 8V, Vectra GLS 2.0 (MPFI) 10/93>03/96, Vectra GSI 2.0 16V 10/93>03/96, Zafira 2.0 (MPFI - Flexpower) 03/04>



GS8319

cable length: 48cm

REPLACES / REEMPLAZA:

Bosch: 0 261 210 119; **Fiat:** 7790917

APPLICATION / APLICACIÓN:

FIAT: Marea, Marea Weekend 2.0i 20V (Turbo) 05/98>



GS8320

REPLACES / REEMPLAZA:

Chevrolet: 25339320, 25366549, 97249413

APPLICATION / APLICACIÓN:

Chevrolet: C4500, C5500, Silverado 2500/3500



GS8321

REPLACES / REEMPLAZA:

Jeep: 4897321AA, 56027865AC, 56027868, 56027868AB, 56027868AC, 56027869AC

APPLICATION / APLICACIÓN:

Jeep: Grand Cherokee Mk1 / Mk2, Wrangler

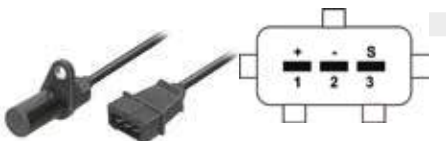

GS8324

cable length: 61,5cm

REPLACES / REEMPLAZA:

Bosch: 0 261 210 124; **Fiat:** 77872650, 46774532, 55187333

APPLICATION / APLICACIÓN:

FIAT: Fiorino Furgão Fire 2P 1.3 8V (MPI - gasoline) 03/00>, Palio EX Fire 2P/4P 1.0 8V (MPI - gasoline) 01>03, Palio EX Fire 2P/4P 1.3 8V (MPI - gasoline) 03, Palio EX Fire Flex 2P 1.0 8V (MPI - alcohol/gasoline) 06>, Palio ELX Fire Flex 4P 1.0 8V (MPI - alcohol/gasoline) 06>, Palio ELX Fire Flex 4P 1.3 8V (MPI - alcohol/gasoline) 04>05, Palio Fire 2P/4P 1.0 8V (MPI - gasoline) 03/00>04, Palio Fire Flex 2P/4P 1.0 8V (MPI - alcohol/gasoline) 06>, Palio Penta Fire 4P 1.0 8V (MPI - gasoline) 03, Palio Weekend EX Fire 4P 1.3 8V (MPI - gasoline) 03>04, Palio Weekend ELX Fire Flex 4P 1.3 8V (MPI - alcohol/gasoline) 05, Palio Young Fire 2P/4P 1.0 8V (MPI - gasoline) 02, Siena ELX Fire Flex 4P 1.0 8V (MPI - alcohol/gasoline) 02>03 / 4P 1.3 8V (MPI - alcohol/gasoline) 06>, Siena EX Fire 4P 1.3 8V (MPI - gasoline) 03>04, Siena Fire 4P 1.0 8V (MPI - gasoline) 05, Siena Fire Flex 4P 1.0 8V (MPI - alcohol/gasoline) 06>, Strada Fire 2P 1.3 8V (MPI - gasoline) 03>05, Strada Fire estendida 2P 1.3 8V (MPI - gasoline) 03>05, Uno Furgoneta Fire 2P 1.3 8V (MPI - gasoline) 03>, Uno Mille Fire 2P/4P 1.0 8V (MPI - gasoline) 02>06, Uno Mille Fire Flex 2P/4P 1.0 8V (MPI - alcohol/gasoline) 06>

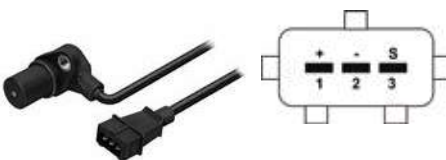

GS8328

cable length: 100cm

REPLACES / REEMPLAZA:

Bosch: 0 261 210 128; **GM:** 92062490, 93232413

APPLICATION / APLICACIÓN:

GM: Astra, Sedan 1.8 (MPFI) 98 >, Astra, Sedan 2.0 (MPFI) 98>, Astra Sedan 2.0 (MPFI - Multipower) 04 >, Blazer, S10 2.4 (MPFI - Flexpower) 07 >, Vectra 2.0 (Flexpower) 05 > Vectra B 2.0 (MPFI) 96 / 98 e 03 / 05, 2.2 (MPFI) 98 > 02, Vectra C 2.0 Flex 05 >, Vectra Hatch 2.0 (Flexpower) 07 >, Zafira 2.0 (MPFI) 01 > 04

GS8331

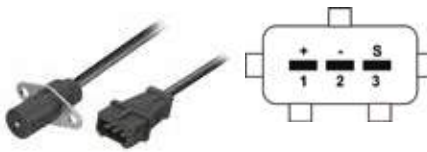

cable length: 44cm

* without air conditioning

REPLACES / REEMPLAZA:

Fiat: 46445731; **Magneti Marelli:** 4820171010

APPLICATION / APLICACIÓN:

FIAT: Fiorino Furgão, Pick up 1.5 8V (MPI - alcohol/gasoline) 97>04, Palio 1.5 8V (MPI - alcohol) 96>00 and 03>04, Palio 1.0 8V MPI 96>00, Young 1.0 8V 01>02, Weekend 1.5 8V MPI 97>00, Weekend 1.0 8V MPI 99>00, Siena 1.5 8V MPI 99>00 and 03>04, Strada 1.5 8V MPI 00>04, Uno, Mille, Furgoneta 1.5 8V MPI 97>04, Mille 1.6 8V MPI 99>04

GS8332

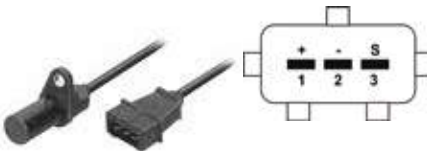

cable length: 73cm

REPLACES / REEMPLAZA:

Magneti Marelli: 1040211101; **Fiat:** 55187332, 55189515, 46479975

APPLICATION / APLICACIÓN:

FIAT: Brava SX, ELX 4P 1.6 16V (MPI - gasoline) 00 > 03, Doblò Cargo 2P 1.6 16V (MPI - gasoline) 02 > 03 / ELX 2P 1.6 16V (MPI - gasoline) 02 > 03, Marea, Marea Weekend SX 4P 1.6 16V (MPI - gasoline) 06 >, Palio 1.6 16V (MPI - gasoline) 96 > 03 / 1.6 16V (MPI - gasoline) 96>00 / ELX 1.6 16V 01>03 / Stile 1.6 16V (MPI - gasoline) 01>02 / Adventure 1.6 16V (MPI - gasoline) 01>03 / Weekend 1.6 16V (MPI - gasoline) 97>98 / Weekend Sport 1.6 16V (MPI - gasoline) 97>00 / Weekend Stile 1.6 16V (MPI - gasoline) 97>03, Siena EL 1.6 16V (MPI - gasoline) 98 / ELX 1.6 16V (MPI - gasoline) 01>03 / HL 1.6 16V (MPI - gasoline) 98 / Sport MTV 1.6 16V (MPI - gasoline) 98 / Stile 1.6 16V (MPI - gasoline) 98>99, Strada LX 1.6 16V (MPI - gasoline) 99>00 / LX extended 1.6 16V (MPI - gasoline) 00>02 / Working extended 1.6 16V (MPI - gasoline) 01 / Working 1.6 16V (MPI - gasoline) 02 / Adventure 1.6 16V (MPI - gasoline) 02

GS8337



cable length: 21cm

REPLACES / REEMPLAZA:

Bosch: 0 261 210 137; **Renault:** 770085931 / 7702218699

APPLICATION / APLICACIÓN:

RENAULT: Clio 1.6i 96 > 97, R19 Sedan 1.6i 93 > 00

GS8339



cable length: 88,5cm | chicote longo

REPLACES / REEMPLAZA:

GM: 90 483 739; **Bosch:** 0 261 210 048

APPLICATION / APLICACIÓN:

GM: Corsa, GSi, Sedan, Wagon 1.0/ 1.6 16V 97 > 02, Corsa 1.6 8V 95>01, Tigra 1.6 16V 96 >

GS8341



REPLACES / REEMPLAZA:

Bosch: 0 986 280 403

Renault: 7700720341, 7700725811, 7700728639, 7700732300, 7700739792

APPLICATION / APLICACIÓN:

Renault: R11 hatch 1.7, R5 Mk2 hatch, Trafic Mk2 minibus/van

GS8342



cable length: 66cm

REPLACES / REEMPLAZA:

GM: 90 451 442; **VDO:** 324003001R

APPLICATION / APLICACIÓN:

GM: Astra 1.8 16V 03>, Celta 1.0/1.4 (MPFI) 01>, Corsa 1.4/1.6 (EFI - MPFI) 95>, Corsa 1.0/1.4/1.6 (MPFI - gasoline/Flexpower) 02>, Corsa 1.8 (MPFI - gasoline) 04>, Meriva 1.8 8V (MPFI - gasoline/Flexpower) 03>, Montana 1.8 8V (MPFI - gasoline/Flexpower) 04>

GS8348



cable length: 58cm

REPLACES / REEMPLAZA:

Bosch: 0 261 210 147, 0 261 210 148 ; **VW:** 06A906433C

APPLICATION / APLICACIÓN:

AUDI: A3 1.6, 1.8, 1.8 20V Turbo 96 / 06, A4, A6, A8, TT 1.8T;

VW: Bora 1.6, 1.8, 2.0 98 / 06, Golf IV 1.6 97 / 04, 1.8 T 97 / 08, Jetta 98 / 05, New Beetle 2.0 98 / 05, Passat 00 / 05, Polo Classic 99 / 01

GS8350

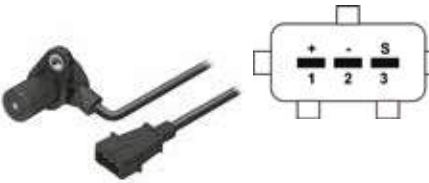

cable length: 83cm

REPLACES / REEMPLAZA:

Bosch: 0 261 210 150; **GM:** 932493251

APPLICATION / APLICACIÓN:

GM: Astra 2.0i (SFI) 16V 99>05 / 2.0 GTC Turbo 05> / Turbo / Cabrio 02>05, Astra Sedan 2.0 (SFI) 16V 99>04, Vectra 2.2i 16V (SFI) 97>05, Vectra CD 2.0 16V (SFI) 96>97, Zafira 2.0 16V (SFI) 01>05

GS8360

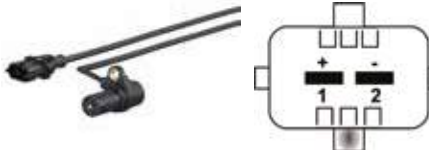

cable length: 62cm

REPLACES / REEMPLAZA:

Bosch: 0 261 210 160 ; **Fiat:** 46470477, 46469866, 46472687, 60814589

APPLICATION / APLICACIÓN:

ALFA ROMEO: Alfa 146 1.8/2.0 TS 16V 98 > 00, Alfa 147 1.6/2.0 TS 16V 00 >, Alfa 156 SW 2.0 TS 16V 97 > 05, Spider 98 /06, Alfa 166 98 > ;

FIAT: Coupé 98 / 00, Marea, Marea Weekend 2.0, 2.4i 20V Turbo 00 >, Stilo 2.4 (MPI) 20V 01 >

GS8361

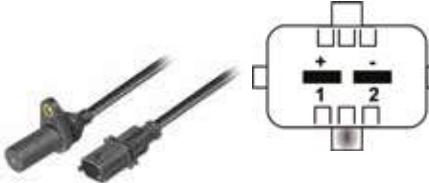

cable length: 66cm

REPLACES / REEMPLAZA:

Bosch: 0 261 210 161; **Fiat:** 46474583, 46754538, 46754539

APPLICATION / APLICACIÓN:

FIAT: Doblo 1.3 (MPI) 16V 01 > 06, Palio 1.0 16V, 1.3 16V (Fire) 00 > 03, Palio Weekend 1.0 16V, 1.3 (Fire) 00 > 03, Siena 1.0 16V, 1.3 16V (Fire) 00 > 03, Strada 1.3 16V (Fire) 00 >

GS8365



REPLACES / REEMPLAZA:

Ford: F6TZ6C365GE, 1L2Z6C315CA

APPLICATION / APLICACIÓN:

Ford: Bronco, E-150, E-250, E-350, F-150, F-250, F-350

GS8383

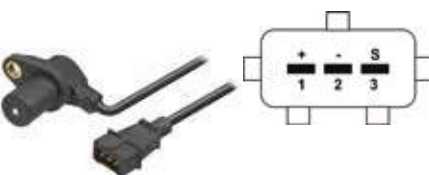

cable length: 33cm

REPLACES / REEMPLAZA:

Bosch: 0 261 210 043, 0 261 210 065, 0 261 210 083, 0 261 210 154; **Hyundai:** 3918022001; **KIA:** 0K04G-18-891, 0K934-18-891

APPLICATION / APLICACIÓN:

GM: Omega, Suprema CD 4.1(MPFI) 10/94>12/98, Pick-up C20 (MPFI) 02/92>12/96, Silverado 4.1(MPFI) 01/96>09/97;

HYUNDAI: Scoupe 1.5/1.5i/GTI 1.5i Turbo 02/90>04/95;

KIA: Sportage 2.0i 16V 4WD FE (16V) 04/94>, Sportage 2.0i 4WD FE 04/94>08/99, Sportage 2.2i 04/94>12/97



GS8384

REPLACES / REEMPLAZA:

Renault: 7700101969, 7700875184B ; **Bosch:** 0 986 280 411

APPLICATION / APLICACIÓN:

RENAULT: Clio 1.0 8V 99 > , Clio II 1.0 8V, 16V 99 > 02, Kangoo 1.0 8V/16V 98 > , Kangoo 1.6 8V 00 > , Scenic 1.6i 96 > 03 , Twingo 1.0 16V 01 > 07

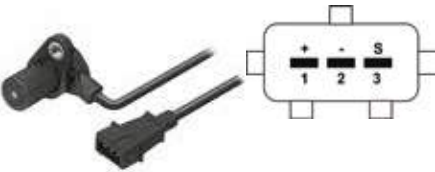

GS8389

cable length: 85cm

REPLACES / REEMPLAZA:

GM: 90 508 637, 93 384 389; **VDO:** 324003008R

APPLICATION / APLICACIÓN:

GM: Astra, Zafira 2.0L 16V 03>09, Astra, Zafira 2.4L 16V 04>09, Vectra B 16V 97 > , Vectra C 2.4 16V 06 >

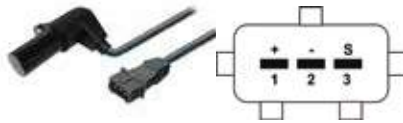

GS8391

cable length: 61cm

REPLACES / REEMPLAZA:

Fiat: 7 083 327, 7 083 791; **GM:** 93 393 867; **VDO:** 324003002

APPLICATION / APLICACIÓN:

FIAT: Doblò, Idea, Palio, Siena, Stilo, Strada, Weekend 1.8 8V 04>;

GM: Corsa, Meriva, Montana 1.8 8V (MPFI - Flexpower) 04>



GS8405

REPLACES / REEMPLAZA:

Bosch: 0.986.280.405; **Renault:** 7700855719, 7700728637, 7700739794, 7700748442; **Delphi:** SS10757-12B1

APPLICATION / APLICACIÓN:

Renault: Mégane 1.4, 1.6 95>, Laguna 93>01, Espace 96>, Twingo 1.2 93>98



GS8416

REPLACES / REEMPLAZA:

Citroën / Peugeot: 1920 7N, 9632400580

Fiat: 9632400580

APPLICATION / APLICACIÓN:

Citroën: C5

Peugeot: 206, 406

Fiat: Scudo, Ducato



GS8427

REPLACES / REEMPLAZA:

Dodge / Jeep: 4713427, 56026882, 56027031, 56029621

APPLICATION / APLICACIÓN:

Jeep: Cherokee, Grand Cherokee, Wrangler Mk1

Dodge: Dakota



GS8433

REPLACES / REEMPLAZA:

VW: 032.906.433, 03C.906.433A

APPLICATION / APLICACIÓN:

VW: Gol, Fox 1.0, 1.6, Polo 1.6, Golf 1.6, Kombi 1.4, Passat 05>, Jetta 05>, Beetle 11>;

Audi: Audi TT 06>, A3, A4, A5 2007> Q3, Q5 2008>;

Skoda: Fabia 99>, Laura 04>, Octavia 04>, Roomster 06>;

Seat: Toledo 04>, Leon 05>, Exeo 08>



GS8434

REPLACES / REEMPLAZA:

Kia: 0K2A618891, 0K04G18891, 0K93418891

Citroën / Peugeot: 591880, 91541027, 9154102780

APPLICATION / APLICACIÓN:

Kia: Retona, Mentor, Sportage

Citroen: BX, ZX hatch

Peugeot: 205, 309, 405



GS8443

REPLACES / REEMPLAZA:

Mazda: ZM0118221A, ZM0118221B

APPLICATION / APLICACIÓN:

Mazda: Protege 1999>2003



GS8450

REPLACES / REEMPLAZA:

GM: 12498965, 10456118

APPLICATION / APLICACIÓN:

GM: Kalos 1.4 2005>, Lacetti 1.4/1.6 2005>, Nubira Saloon/Estate 1.6 2005>2011, Tacuma 1.6 2005>



GS8468

REPLACES / REEMPLAZA:

Kia: 0K30A18891

APPLICATION / APLICACIÓN:

Kia: Sedona, Rio Mk1 saloon/estate



GS8471 // NEW //

REPLACES / REEMPLAZA:

Mitsubishi: J5T38471

Honda: 37510-59BJ01

APPLICATION / APLICACIÓN:

HONDA: Civic X Hatchback 1.5 VTEC 2017>, CR-V 1.5/2.4 2017>



GS8500

REPLACES / REEMPLAZA:

Hyundai: 39180-23500; **Kia:** 39180-23910

APPLICATION / APLICACIÓN:

Hyundai: Tucson 2.0 16V 05>09, Elantra 01>10, Tiburon 03>08, I30 2.0 07>;
Kia: Soul 2010, Sportage 05>09, Cerato 2.0 06>, Carens 2.0 04>



GS8513 // NEW //

REPLACES / REEMPLAZA:

Bosch: 0 281 002 513; **Iveco:** 500374763

APPLICATION / APLICACIÓN:

FIAT: Ducato Bus 2.3 2002, Ducato Kasten 2.3 2002, DUCATO Pritsche/Fahrgestell 2.3 2002 IVECO: DAILY III, IV, V, Kasten/Kombi 29L 10V/12V/14, 35 C 12 V, 35 S 12 V, 35 C 14, 35 C 14, 35 S 14, 35 C 17, 35 S 17, 35 S 10, 40 C 17, 40 S 17, 50 C 14, 50 C 17, 65 C 17 2002>2014 DAILY III Bus 35 S 12, 35 C 12, 40 C 12, 35 S 14, 50 C 14, 40 C 17, 50 C 17 2003>2006 DAILY III, IV, V, VI Pritsche/Fahrgestell 29 L 10, 29 L 12, 29 L 14, 35 C 10 V, 35 S 10 V, 35 C 12, 35 S 12, 35 C 14, 35 C 14, 35 S 14, 35 C 17, 35 S 17, 40 C 17, 40 S 17, 50 C 14, 50 C 17 2002>2014 MASSIF Single Cab 3.0 HPI/HPT 2008>2011 MASSIF Pick-up 3.0 HPI/HPT 2008>2011 MASSIF Station Wagon 3.0 HPI/HPT 2008>2011 AUZ: PATRIOT 2.3 D 2006



GS8515

REPLACES / REEMPLAZA:

Chevrolet / Daewoo: 10456515, 96418382

APPLICATION / APLICACIÓN:

Chevrolet: Captiva, Nubira, Tacuma
Daewoo: Evanda, Lacetti



GS8571

REPLACES / REEMPLAZA:

Mitsubishi: J5T32571, 1865A069

APPLICATION / APLICACIÓN:

Mitsubishi: Shogun 2.0 GDI 2000>2007, Pajero Pinin 2.0 GDI 2000>2007, Outlander EX



GS8542 // NEW //

REPLACES / REEMPLAZA:

GM: 96253542, 96434780; **Delphi:** SS10894; **Magneti Marelli:** 064848106010; **Meat & Doria:** 87233; **Mobiletron:** CS-K007; **M.T.E:** 70583

APPLICATION / APLICACIÓN:

GM: Aveo 1.4 2003>2008, Lacetti 1.4/1.6 2005>, Nubira 1.6 2005>2011, Rezzo 1.6 2005> DAEWOO: Kalos 1.4 2002>2003, Lacetti 1.4/1.6 2004>, Nubira 1.6 1997>2002, Rezzo 1.6/1.8 2000>



GS8556 // NEW //

REPLACES / REEMPLAZA:

Nissan: 01436-00QAC, 23750-00QAG, 23750-00QOE; **Renault:** 7700108073, 8200468647, 8200647556; **Mobiletron:** CS-E096

APPLICATION / APLICACIÓN:

NISSAN: Kubistar 1.6 16v 2003>;
RENAULT: Clio II 1.4 16v 1999>2004, Clio II 1.6 16v 1998>, Espace III 2.0 2001>2002, Espace III 2.0 16v 1998>2002, Grand Scénic II 1.6 2004>, Kangoo I 1.6 16v 2001>, Kangoo I 4x4 1.6 16v 2001>, Kangoo I Express 4x4 1.6 16v 2001>, Laguna II 1.8 16v 2001>, Laguna II Grandtour 1.8 16v 2001>, Megane I 1.4i 1999>2000, Megane I 1.4i 16v 1999>2000, Megane I 1.6 1997>2001, Megane I 1.6 16v 1999>2003, Megane I 1.6e 1996>1999, Megane I 1.8 16v 1999>2002, Megane I 2.0i 1996>2003, Megane I 2.0i 16v 2000>-, Megane I Cabriolet 1.6 16v 1999>2003, Megane I Cabriolet 1.6e 1996>1999, Megane I Cabriolet 2.0i 1999>2003, Megane I Classic 1.6 16v 1999>2003, Megane I Classic 1.6e 1996>1999, Megane I Classic 2.0i 1996>2003, Megane I Classic RT 2.0 2001>2003, Megane I Coach 1.6 16v 1999>2003, Megane I Coach 1.6e 1996>1999, Megane I Coach 2.0i 1996>2003, Megane I Grandtour 1.6 16v 1999>2003, Megane I Grandtour 1.6e 1999>2003, Megane I Scenic 1.6 16v 1998>1999, Megane I Scenic 1.6e 1996>1999, Megane I Scenic 2.0i 1997>1999, Megane II 1.6 16v 2003>, Megane II Coupé-Cabriolet 1.6 2003>, Megane II Coupé-Cabriolet 1.6 16V 2006>, Megane II Familiare 1.6 2003>, Megane II Familiare 1.6 16v 2006>, Megane II Tre Volumi 1.6 2003>, Megane II Tre Volumi 1.6 16v 2006>, Scenic I 1.6 2001>2003, Scenic I 2.0 16v 1999>2003, Scenic I 2.0i 1996> Scenic I 2.0i 16v 2001>, Scenic II 1.6 2003>



GS8600

REPLACES / REEMPLAZA:

Hyundai/Kia: 39650-42600; **Meat & Doria:** 87760

APPLICATION / APLICACIÓN:

Hyundai: Galloper II 2.5 1998>2003, Starex 2.5 1997>2007, H-1 Van 2.5 2000>2007, H100 Van 2.5 1994>2004, H100 Pickup 2.5 1994>2004, Terracan 2.5 2001>2006

Kia: K2500 2.5 2003>, Pregio Bus 2.5 1995>2004, Pregio Box 2.5 Tci 2002>



GS8608

REPLACES / REEMPLAZA:

Suzuki: 3322077E00, 3322052D01

APPLICATION / APLICACIÓN:

Suzuki: Baleno hatch/saloon/estate, Grand Vitara, SX4, Wagon R+



GS8643 // NEW //

REPLACES / REEMPLAZA:

VW: 041906433A

APPLICATION / APLICACIÓN:

VW: Gol GL 2003>2006, Gol GL 2006>2010, Gol G4 2011>2014, Saveiro 2006>2010, Parati 2011>2013, Fox, Voyage, Golf, Polo, Spacefox (All with engine AP)



GS8622 // NEW //

REPLACES / REEMPLAZA:

Mitsubishi: MD320622, J5T25082A, PC96; **Meat & Doria:** 87728; **Mobiletron:** CS-J010

APPLICATION / APLICACIÓN:

MITSUBISHI: Pajero/Montero II 3.0/3.5 1990>1999, Pajero/Montero Sports 3.0 1998>



GS8700

REPLACES / REEMPLAZA:

Hyundai: 39310-02700, 39310-02600

APPLICATION / APLICACIÓN:

Hyundai: i10 Hatch 1.1 2008>2013, i10 Hatch 1.1 2011>2013

Kia: Picanto Mk1 2004>



GS8712

REPLACES / REEMPLAZA:

Chevrolet: 12567712, 24576398, 71739267

APPLICATION / APLICACIÓN:

Opel: Astra G, Signum, Vectra B/C, Zafira B



GS8726

REPLACES / REEMPLAZA:

Fiat: 71739726

Opel: 01045660, 010456604, 01238938

APPLICATION / APLICACIÓN:

Fiat: Stilo hatch

Opel: Astra G/H, Corsa C, Vectra B/C, Zafira



GS8761

REPLACES / REEMPLAZA:
Jeep: 33004761
 APPLICATION / APLICACIÓN:
Jeep: Cherokee 4.0i, Comanche, Wagoneer, Wrangler



GS8780

REPLACES / REEMPLAZA:
Citroën / Peugeot: 9640627780, 1920FP, 1920EN;
Suzuki: 33220-67G01-000
 APPLICATION / APLICACIÓN:
Citroën: C4, C5, C6, Xsara Picasso 2006>;
Peugeot: 307, 407 2005>;
Suzuki: Gran Vitara



GS8795

REPLACES / REEMPLAZA:
GM: 90412795; **Opel:** 6238000
 APPLICATION / APLICACIÓN:
GM: Corsa 1.0, 1.6 16V 93>03, Tigra 1.6 94>, Astra 91>, Zafira 99>05



GS8826

REPLACES / REEMPLAZA:
Mitsubishi: MD342826, J5T25871, ADC47205
 APPLICATION / APLICACIÓN:
MITSUBISHI: Shogun/Pajero MK1 2.5 TD 1989>1991, Shogun/Pajero MK1 Soft Top 2.5 TD 1986>1990, Shogun/Pajero MK2 2.5 TD 1990>1999, Shogun/Pajero MK2 Soft Top 2.5 TD 1990>2000, Pajero III 2.5 Tdi 2000>2006, Shogun/Pajero MK2 Classic 2.5 TD 2002->, L-200 2.5 TD 4WD 1992>2007



GS8865 // NEW //

REPLACES / REEMPLAZA:
Fiat: 55261865
 APPLICATION / APLICACIÓN:
FIAT: Argo HGT 1.8 2017>



GS8868 // NEW //

REPLACES / REEMPLAZA:
GM: 96325868, 93434780; **Delphi:** SS11055; **Magneti Marelli:** 064848210010; **Meat & Doria:** 87491, 87491E;
 Mobiletron: CS-K010
 APPLICATION / APLICACIÓN:
CHEVROLET: Spark 1.0/1.2 2010>, Aveo 1.4 2005>2008, Matiz 0.8/1.0 2005>2007;
DAEWOO: Matiz 0.8/1.0 1998>2003, Kalos 1.2/1.4 2002



GS8880

REPLACES / REEMPLAZA:
Citroën / Peugeot: 9639999880, 9637465980 1920AW; **Bosch:** 0.986.280.408; **Delphi:** SS10747-12B1
 APPLICATION / APLICACIÓN:
Citroën: Aircross 1.6 10>, C2 1.6 04>09, C3 1.4, 1.6 03>, C4 09>, Hoggar 1.4, 1.6 10>, Xsara 1.6 00>06, Nemo 08>;
Peugeot: 206 1.4, 1.6 Flex All, 207 1.4, 1.6 08>13, 307 1.6 00>

GS8884

REPLACES / REEMPLAZA:
Jeep: 56026884, 56027280
 APPLICATION / APLICACIÓN:
Jeep: Cherokee, Grand Cherokee, Wrangler Mk2

GS8891

REPLACES / REEMPLAZA:
Kia: 0K2A618891
Peugeot: 591879, 591884
 APPLICATION / APLICACIÓN:
Kia: Carens, Sedona, Retona, Mentor, Sportage
Peugeot: 505 Saloon 2.8 Gti V6

GS8918

REPLACES / REEMPLAZA:
Suzuki: 3322070E00
Subaru: 3322070E00
Chevrolet: 30015918
 APPLICATION / APLICACIÓN:
Suzuki: Grand Vitara
Subaru: Justy Mk2 hathc
Chevrolet: Tracker

GS8920

REPLACES / REEMPLAZA:
Citroën / Peugeot: 9639999980, 1920AV;
Delphi: SS10748-12B1
 APPLICATION / APLICACIÓN:
Peugeot: 206 1.4, 1.6 98>, 306 1.6 94>, 307>;
Citroën: C3 1.4/1.6, C4 1.4/1.6, Xsara Picasso 1.6 97>05;
Renault: Mégane 95>03

GS8971

REPLACES / REEMPLAZA:
Byd: 28091971
 APPLICATION / APLICACIÓN:
Byd: F3

GS8991 // NEW //

REPLACES / REEMPLAZA:
GM: 12590991; **Bosch:** 0 261 210 274
 APPLICATION / APLICACIÓN:
GM: Captiva 3.2 4WD 2006->
Cadillac: CTS/CTS Sport Wagon/CTS Coupe 3.6/3.6 AWD 2008->, SRX 3.6/3.6 AWD 2004>2008
Buick: Enclave 3.6 2007>2008
Opel: Antara 3.2 V6 2007->, Insignia Hatch/Saloon/Estate 2.8 V6 Turbo 4x4 2008->
Suzuki: Grand Vitara Mk2 3.2 All-wheel Drive 2009>2015

**GS8992**

REPLACES / REEMPLAZA:

GM: 12588992

APPLICATION / APLICACIÓN:

CHEVROLET: Agile, Montana, Onix, Prisma, Captiva 2.4 2006, Malibu 2.4 2012;**OPEL:** Antara 2.4 2006>, GT Convertible 2.0 2007>, Insignia 2.0 Turbo 2008>;**SAAB:** 9-3 2.0 2002>2015, 9-3X 2.0 2009>2012, 9-5 2.0 2010>2012



EMS COMPONENTS | SISTEMA DE CONTROL DE MOTOR

KNOCK SENSOR | SENSOR DE DETONACIÓN



GS5000 // NEW //

REPLACES / REEMPLAZA:

KIA/ Hyundai: 39320-3C000

APPLICATION / APLICACIÓN:

HYUNDAI: Equus/Centennial 4.5 1999>2003, Grandeur 3.3 2005>2011, IX55 3.8 V6 4WD 2011>, Sonata Mk5 3.3 2005>2010

KIA: Opirus 3.8 V6 2006>, Sorento Mk1 SUV 3.3 V6 4WD 2007>



GS5003

REPLACES / REEMPLAZA:

Ford: 1N1A-12A699-AA; Siemens/VDO: 330 001 003R

APPLICATION / APLICACIÓN:

FORD: EcoSport 1.6 >04, Focus 1.8 Todos, Novo Fiesta 1.0/1.6 >04;



GS5004

Cable length: 67cm - 3 Pins

REPLACES / REEMPLAZA:

Bosch: 0 261 231 004, 0 261 231 038; **VW:** 034.905.377A, 053.905.377.2, 054.905.377A

APPLICATION / APLICACIÓN:

FORD: Escort XR3 2.0i (Com LE - Jetronic) 01/93>, Royale, Versailles Ghia 2.0i Todos, Royale, Versailles GL 2.0i 09/93;

GM: Kadett 2.0 GSI 11/91>, Monza Classic (MPFI) 92>, Omega, Suprema GLS 2.0 03/93>;

VW: Gol GTi 2.0 09/88>12/92, Logus 2.0 92>96, Pointer 2.0 93>96, Quantum, Santana 2000 GLI/GLSI 09/93>, Quantum, Santana 2000i GLS >08/93, Santana EX 08/89>08/93;



GS5006

2 Pins

REPLACES / REEMPLAZA:

Bosch: 0 261 231 001, 0 261 231 006; **GM:** 90.510.281, **Opel:** 1 238 345, 6 238 341; **Renault:** 7 700 871 678; **VW:** 026.905.377.2

APPLICATION / APLICACIÓN:

GM: Vectra 2.0 (MPFI), Vectra GSI 2.0 16V (SFI) 10/93>;

RENAULT: R19 1.7 (Importado) 89>95;

VW: Gol, Parati, Saveiro 1.6/1.8/2.0 Mi 96>, Polo Classic 1.8Mi 98>, Quantum, Santana 1.8/2.0 Mi 96>;



GS5007

Cable length: 50cm - 3 Pins

REPLACES / REEMPLAZA:

Bosch: 0 261 231 007, 0 261 231 033, 0 261 231 070, 0 261 231 071; **Fiat:** 7.669.123, 60.808.063

APPLICATION / APLICACIÓN:

ALFA: 164 3.0 Todos;

FIAT: Tempra - Turbo 04/94>, Tipo 1.6 (MPI) 12/95>, Uno 1.6R (MPI) 03/93>;



GS5046

2 Pins

REPLACES / REEMPLAZA:

Bosch: 0 261 231 045, 0 261 231 046; **NTK:** KNE05; **VW:** 030.905.377A

APPLICATION / APLICACIÓN:

GM: Blazer, S10 2.2 (MPFI) 08/97>, Blazer, S10 2.4 (MPFI) 12/00>, Zafira 2.8 8/16V (MPFI) 04>;

VW: Bora 2.0 00>, Gol, Parati 1.0 Mi 16V (Turbo) 00>, Golf 2.0 99>;



GS5075

Cable length: 31cm

REPLACES / REEMPLAZA:

Bosch: 0 261 231 075; Siemens/VDO: 330 001 005R; **VW:** 037.905.377, 037.905.377A

APPLICATION / APLICACIÓN:

VW: Bora 2.0 12/00>08/02, Gol 1.0 8V, Parati 1.0 16V (Turbo) 06/02>, Gol, Parati 2.0 16V 95>, Golf A4 08/99>09/00, New Beetle 12/99>;

GS5077



2 Pins

REPLACES / REEMPLAZA:

Siemens/**VDO**: 330 001 002R; **VW**: 030.905.377C

APPLICATION / APLICACIÓN:

AUDI: A3 1.8 05/00>;

VW: Bora 2.0 09/02>, Gol, Parati, Saveiro 1.6/1.8/2.0 08/01>, Golf 1.8/2.0 03/00>, Polo 1.6/2.0 05/02>, Polo Sedan 1.6/2.0 11/02>;

GS5079



Cable length: 57cm - 2 Pins

REPLACES / REEMPLAZA:

Bosch: 0 261 231 079; **GM/Opel**: 90.511.177

APPLICATION / APLICACIÓN:

GM: Astra 2.0 16V 02/99>, Vectra 2.0 (MPFI) 07/98>12/02, Vectra 2.2 16V (MPFI) 04/96>11/97, Vectra 2.2 16V (SFI) 01/03>06/05, Vectra CD 2.0 16V (SFI) 12/97>06/05, Omega 2.5i (Ecotec) 01/94>11/00, Omega 3.0i (Ecotec) 01/99>02/01;

GS5095



Cable length: 42cm - 3 Pins

REPLACES / REEMPLAZA:

Bosch: 0 261 231 095; **Fiat**: 60.592.752

APPLICATION / APLICACIÓN:

FIAT: Marea, Marea Weekend 2.0i 20V 05/98>, Marea, Marea Weekend 2.0i 20V (Turbo) 05/98>;

GS5144



Cable length: 42cm - 3 Pins

REPLACES / REEMPLAZA:

Bosch: 0 261 231 144; **Fiat**: 46.525.288

APPLICATION / APLICACIÓN:

FIAT: Marea, Marea Weekend 2.4i 20V 01>

GS5152



2 Pins

REPLACES / REEMPLAZA:

Bosch: 0 261 231 148; **Fiat**: 46.538.111, 46.815.152, 55.190.562; **NTK**: KNE11, KNE21

APPLICATION / APLICACIÓN:

FIAT: Brava Hatch 1.2 16V 2000>2001, Bravo Mk1 Hatch 1.2 16V 2000>2001, Bravo Mk2 1.4/1.4 T Jet 2007>2014, Idea MPV 1.2/1.4 16V 2004>, Liena 1.4 T-Jet 2007>;

01>, Siena 1.0/1.3 16V, Strada 1.3 16V (Fire) 03/00>, Uno 1.0 8V (MPI - Fire) 02>, Uno Furgoneta 2P 1.3 8V (MPI - Fire) 03>04;

GS5176 // NEW //



REPLACES / REEMPLAZA:

Bosch: 0 261 231 176; **GM**: 93 399 899; **Fiat**: 55186669

APPLICATION / APLICACIÓN:

OPEL: Agila 1.0/1.2 2003>2007, Astra H/H GTC Hatch 1.4 2004>2010, Astra H Estate 1.4 2004>2010, Combo Tour MPV 1.4 2004>2011, Combo Van Body/Estate 1.4 16V 2005>, Corsa C Hatch 1.0/1.2/1.4 2003>2009, Corsa C Van 1.2 2005>2006, Corsa D Hatch 1.0/1.2/1.4/1.6 Turbo 2006>2014, Meriva 1.4 16V/1.6 Turbo 2004>2010, Tigra Twintop Convertible 1.4 2004>2010;

FIAT: Brava Hatch 1.2 16V 2000>2001, Bravo Mk1 Hatch 1.2 16V 2000>2001, Bravo Mk2 1.4/1.4 T Jet 2007>2014, Idea MPV 1.2/1.4 16V 2004>, Liena 1.4 T-Jet 2007>, Panda Mk2 Hatch 1.4 2006>, Punto Mk2 Hatch 1.2 16V/1.4 1999>2012, big Punto 1.4 16V/T-Jet 2005>, Stilo Hatch/Estate 1.2/1.4 16V 2002>2008, 500 1.4 2007>;

ABARTH: big Punto 1.4 2007>2010;

ALFA ROMEO: GT 2003>2010 LANCIA: Musa 1.4 2004>2012, Thesis 2.0 Turbo 2002>2009, Ypsilon 1.2/1.4 16V 2000>2011;

PORSCHE: 911/911 Convertible 3.6/3.8 Carrera 2004>2008, Boxter 2.7 /3.2/3.4 2004>2009, Cayman 2.7/3.4 2005>2009

GS5197 // NEW //

REPLACES / REEMPLAZA:

Bosch: 0 261 231 197; **BMW:** 13627552114; **Citroën/ Peugeot:** V755211480, 1920 LT; **Mini:** 13627552114; **Meat & Doria:** 87791

APPLICATION / APLICACIÓN:

BMW: 114i/ 116i/ 118i/ 120i 2010>, 316i/320i Efficient Dynamics 2012>2016

CITROËN: C4 Hatch 1.6 THP 140/150 2008>2011, C4 II 1.6 THP 155 2009>, C4 Coupe 1.6 THP 150 2008>2011, C4 Picasso MPV 1.6 THP 140/155 2008>2013, C4 Picasso II 1.6 THP 155/165 2013>, C4 Grand Picasso MPV 1.6 THP 155 2010>, C4 Grand Picasso II 1.6 THP 155/165 2013>, C5 Mk3 Hatch/Estate 1.6 THP 150/155 2009>, DS3 1.6 THP 150/155/165/Racing 2010>2015, DS3 Convertible 1.6 THP 150/155/165 2013>2015, DS4 1.6 THP 150/155/165/200 2011>2015, DS5 1.6 THP 155/165/200 2011>2015

MINI: Mini Cooper S 06>13, Mini John Cooper Works/John Cooper Works GP 2007>2013, Mini Convertible Cooper S 2007>2015, Mini Convertible John Cooper Works 2008>2015, Mini Roadster Cooper S 2011>2015, Mini Roadster John Cooper Works 2011>2015, Mini Countryman Cooper S/Cooper ALL4/ Cooper S ALL4 2010>2016, Mini Countryman John Cooper Works 2011>2016, Mini Mk2 Clubman Cooper S 2007>2014, Mini Mk2 Clubman John Cooper Works 2007>2014, Mini Coupe Cooper S 2010>2015, Mini Coupe John Cooper Works 2010>2015, Mini Paceman Cooper S/Cooper ALL4/ Cooper S ALL4 2012>2016, Mini Paceman John Cooper Works 2012>2016

PEUGEOT: 207 Hatch 1.6 16V Turbo/RC 2006>, 207 CC Convertible 1.6 16V Turbo 2007>, 207 SW Estate 1.6 16V RC 2007>, 208 1.6/1.6 THP 165/1.6 GTi 2012>, 308 Hatch 1.6 16V/1.6 GTi 2007>, 308 SW Estate 1.6 16V 2007>, 308 CC Convertible 1.6 16V/1.6 THP 2009>, 308 II 1.6 THP 125/150/163/1.6 GT205/1.6 GTi 2013>, 308 SW II 1.6 THP 125/150/155/163/ 1.6 GT 205 2014>, 508 1.6 THP 2010>, 508 SW 1.6 THP 2010>, 3008 1.6 THP/1.6 Turbo 2009>, 3008 SUV 1.6 THP 165 2016>, 5008 1.6 THP 150/163 2012>, RCZ 1.6 THP 270 2013>

GS5327 // NEW //

REPLACES / REEMPLAZA:

Delco: 2133944; **GM:** 12600327

APPLICATION / APLICACIÓN:

GM: Savana 1500 4.3 2008>2014, Sierra 1500 4.3 2017>2013, Silverado 1500 4.3 2017>2013

GS5377

Cable length: 34cm

REPLACES / REEMPLAZA:

VW: 06A.905.377A

APPLICATION / APLICACIÓN:

VW: Golf 1.6/1.6 SR 99>;

GS5460 // NEW //

REPLACES / REEMPLAZA:

Fiat: 55223460

APPLICATION / APLICACIÓN:

FIAT: Argo HGT 1.8 2017>, Bravo 1.8 16V flex 2011>, Doblò 1.8 16V flex 2010>, Grand Siena 1.6 16V flex 2013>, Idea 1.6/1.8 16V flex 2011>, Palio 1.6 16V flex 2012>, Punto 1.6/1.8 16V flex 2013>, Siena 1.6 16V flex 2011>2012, Strada 1.8 16V flex 2011>2012, Toro 1.8 16V flex 2016>

JEEP: Renegade 1.8 16V flex 2015>

GS5477 // NEW //

REPLACES / REEMPLAZA:

Audi / Seat / Skoda / VW: 06A905377B

APPLICATION / APLICACIÓN:

AUDI: A3 Mk1 Hatch 1.6/1.8/1.8T/1.8T quattro/S3 quattro 1996>2003, TT Coupe Mk1 1.8T/1.8T quattro/3.2 VR6 quattro 1998>2006, TT Roadster Cabrio Mk1 1.8T/1.8T quattro/3.2 VR6 quattro 1999>2006

SEAT: Leon Mk1 Hatch 1.6/1.8 20V/1.8 20V T/1.8 20V T 4/1.8 T Cupra R/2.8 Cupr 4 a 4 1999>2006, Toledo Mk2 Saloon 1.6/1.8 20V T 1998>2004

SKODA: Octavia Mk1 Hatch/Estate 1.6/1.8T/1.8T 4x4 1997>2010

VW: Bora Saloon 1.6/1.8/1.8 4 Motion/1.8 T/1.9 TDI/1.9 TDI 4 Motion 1998>2005, Bora Estate 1.6/1.8 4 Motion/1.8 T 1999>2005, Golf Mk4 Hatch 1.6/1.8/1.8 4 Motion/1.8T 1997>2005, Golf Mk4 Estate 1.6/1.8 4 Motion/1.8 T 1999>2006, New Beetle 1.8T 1999>2010, Polo Classic Mk3 Saloon 100 1.6 1995>2001, Polo Mk3 Estate 1.6 1997>2001

GS5480 // NEW //

REPLACES / REEMPLAZA:

Peugeot/ Citroën: 9660524480, 9632754980; **Meat & Doria:** 87615

APPLICATION / APLICACIÓN:

PEUGEOT: 206 1.4/2.0 16V 1998>, 207 1.4 16V 2007>, 208 1.4/1.6 16V 2012>, 307 2.0 16V 2000>, 308 1.4/1.6 16V 2007>, 406 1.8/2.0 2000>2004, 407 1.8/2.0 16V 2004>, 508 1.6 16V 2010>

CITROËN: Berlingo MultiSpace/Van Mk2 1.6 Vti 2009>, C3 1.4i 2002>, C3 picasso 1.4/1.6 Vti 2009>, C4 hatch 1.6 Vti 2008>2011, C4 hatch/ coupe/ picasso 2.0 16v 2004>2008, C5 Mk1 hatch/estate 1.8/2.0 16V 2001>2004, C5 Mk2 hatch/estate 1.8 16V 2004>, C5 Mk3 hatch/estate 1.6 Vti 2010>, DS3 1.2/1.4/1.6 2010>2015, DS4 1.6 Vti 2011>2015, Xsara Picasso 1.8 16v 2000>

GS5530 // NEW //



REPLACES / REEMPLAZA:

Honda: 30530-R1A-A01; **Meat & Doria:** 875027

APPLICATION / APLICACIÓN:

HONDA: Civic Ix 1.8 i-VTEC (FK2)/ 2012>, Civic Ix Saloon 1.8 (FB2)/ 2012>, Civic Ix Tourer 1.8 i-VTEC (FK2)/ 2014>, Cr-Z 1.5 Hybrid/ 2012>, Insight 1.3 Hybrid (ZE28, ZE2)/ 2009>

GS5577



Cable length: 36cm - 3 Pins

REPLACES / REEMPLAZA:

Audi/VW: 06A.905.377

APPLICATION / APLICACIÓN:

AUDI: A3 1.8/1.8 Turbo 01>;

VW: Bora, Golf 1.8 01>;

GS5740



Cable length: 37cm - 3 Pins

REPLACES / REEMPLAZA:

Fiat: 46.522.740; **NTK:** KNE03A

APPLICATION / APLICACIÓN:

FIAT: Brava, Marea 1.8 16V 00>;

GS5832



Cable length: 20cm - 3 Pins

REPLACES / REEMPLAZA:

Fiat: 60.602.832; **NTK:** KNE03

APPLICATION / APLICACIÓN:

FIAT: Palio, Siena 1.0/1.5/1.6 8V, 1.6 16V (MPI) 96>00, Uno 1.5 (MPI)

97>;



EMS COMPONENTS | SISTEMA DE CONTROL DE MOTOR

PHASE SENSOR | SENSOR DE FASE

GS9000 // NEW //



REPLACES / REEMPLAZA:

Hyundai/ Kia: 39300-2A000; **Magneti Marelli:** 64847158010; **Meat & Doria:** 87464; **Mobiletron:** CS-K009

APPLICATION / APLICACIÓN:

HYUNDAI: Accent 1.5 2005>2010, Elantra, i10, i20, i30, i40 - Getz 1.5 2005>2009, i10 1.1 2008>2011, i20 1.4/1.6 2008>2015, ix20 1.4/1.6 2010>, i30 1.6 2007>2011, ix35 1.7 2010>, i40 1.7 2012, Matrix 1.5 2001>2010 **KIA:** Carens 1.6 2010>, Cee'd 1.6 2006>2012, Pro Cee'd 1.6 2008>2012, Cerato 1.5/1.6 2005>2009, Picanto 1.1 2005., Rio 1.5 2005, Soul 1.6 2009>, Sportage 1.7 2010> Venga 1.4/1.6 2010>

GS9003



REPLACES / REEMPLAZA:

Honda: 37510-PNB-003; **Denso:** 17701M30

APPLICATION / APLICACIÓN:

Honda: Civic 2002>2010, New Civic, CRV 2002>2010, Fit 2003>2008, Acura RDX 2007>2010, RSX 2002>2006, Acoord 2003>2007, Element 2003>2010

GS9004



REPLACES / REEMPLAZA:

Ford: 9S6G12K073AA, 9S6G12K073BA

APPLICATION / APLICACIÓN:

Ford: Ka 2008>2013, EcoSport 2007>2013, Fiesta 2007>2013, Courier Zetec 2007>2013, Focus 1.6 Flex 2008>

GS9006



REPLACES / REEMPLAZA:

Bosch: 0 232 103 006; **Chevrolet:** 93216451; **Volga:** 406384705006

APPLICATION / APLICACIÓN:

UAZ: Hunter 2.7 2004>, Patriot 2.7 2004>

GAZ: Volga 2.5 1972>1993, Volga estate 2.5 1972>1993

GS9010



REPLACES / REEMPLAZA:

Hyundai / Kia: 3935025000, 3935025010

APPLICATION / APLICACIÓN:

Hyundai: Sonata Mk5

Kia: Carens, Magentis

GS9015



REPLACES / REEMPLAZA:

GM / Opel: 10456506, 96418393, 90506101;

Isuzu: 8104565060

APPLICATION / APLICACIÓN:

GM: Astra, Vectra 2.0 16V, Optra 2001>2010;

Daewoo: Leganza 1999>2002, Nubira 1999>2002;

Isuzu: Amigo 1998>2000, Rodeo 1998>2003



GS9020

REPLACES / REEMPLAZA:

Denso: 23731-EN20A, 23731-1VA0A

APPLICATION / APLICACIÓN:

NISSAN: Qashqai 2.0/2.0 All-wheel Drive 2007>2013, Tiida Saloon/Hatchback 1.8 2007>2012, X-Trail 2.0/2.0 FWD 2007>2013



GS9023

REPLACES / REEMPLAZA:

Ford: 95BF12K073AB

Mobiletron: CS-E107

Meat & Doria: 87173

APPLICATION / APLICACIÓN:

FORD: Escort MK5 Hatch/Estate 1.3 1990>1992, Escort MK6 hatch/saloon/estate 1.3 1992>1995, Escort MK7 hatch/saloon/estate 1.3 1995>1998, Focus MK1 hatch/saloon/estate 1.4/1.6 1998>2004, Ka 1.3i 1996>2008, Orion MK3 Saloon 1.3 1990>1993, Transit MK5 / MK6 Minibus/Van 2.0 1994>2000

MAZDA: 121 MK3 hatch 1.25/1.3 1996>2003



GS9024

REPLACES / REEMPLAZA:

Bosch: 0 232 101 024

Audi/ Skoda/ Seat/ VW: 058 905 161 B

Meat & Doria: 87277

APPLICATION / APLICACIÓN:

AUDI: A3 Mk1 hatch 1.8 T quattro 1996>2003, A3 Mk1 hatch S3 quattro 1999>2002, A4 Mk2 Saloon/Avant/Estate 1.8/2.0/2.4 2000>2004, A4 Convertible 1.8 T/2.0/2.4 2002>2009, A4 Mk3 Saloon/Avant/Estate 1.8T/1.8T quattro 2004>2008, A6 Mk1 Avant/Estate 1.8/2.0/2.1995>1997, A8 Mk1 Saloon 2.8/3.7/4.2 1994>2002, TT Coupe Mk1 1.8T 2002>2006

SKODA: Octavia Mk1 hatch/estate 1.8 1996>2010, SuperB Mk1 Saloon 1.8/2.8 2001>2008

SEAT: Alhambra MPV 1.8T 20v 1997>2010, Cordoba Mk1 Saloon 1.8T 20v Cupra 2000>2002, Ibiza Mk2 hatch 1.8T 20v Cupra 2000>2002, Leon Mk1 hatch 1.8 1999>2006, Toledo Mk2 Saloon 1.8 20v 1998>2004

VOLKSWAGEN: Bora Saloon 1.8 1998>2005, Golf Mk4 hatch/estate 1.8 1997>2005, New Beetle 1.8T 2001>2010, Passat Mk5 Saloon 1.8/2.8 1996>2000, Phaeton 4.2 V8 4motion 2003>2016, Touareg 4.2 V8 2002>2006



GS9026

Cable lenght: 32cm

REPLACES / REEMPLAZA:

Bosch: 0 232 101 026, 0 232 101 037; **Fiat:** 7.777.344, 60.811.201

APPLICATION / APLICACIÓN:

FIAT: Brava, Marea 1.8i 16V 08/99>, Marea, Marea Weekend 2.0i 20V 05/98>, Marea, Marea Weekend 2.0i 20V (Turbo) 05/98>



GS9030

REPLACES / REEMPLAZA:

Hyundai / Kia: 393502B000, 393502B010, 393502B030

APPLICATION / APLICACIÓN:

Hyundai: i10, i20, ix20, i30

Kia: Carens, Cee'd, Cerato, Soul, Venga



GS9031

REPLACES / REEMPLAZA:

VW: 06A905161 B/C;

Bosch: 0232101031

APPLICATION / APLICACIÓN:

Audi: A3 96>03, A4 95>00, A4 Avant 95>09;

Seat: Alhanbara 96>, Cordoba 99>02, Ibiza 99>02, Leon 99>06, Toledo 99>06;

VW: Golf, Passat 2.0 99>

GS9036



Cable length: 38cm

REPLACES / REEMPLAZA:

Bosch: 0 232 101 036; **Fiat:** 46.520.138

APPLICATION / APLICACIÓN:

FIAT: Marea, Marea Weekend 2.4i 20V 08/00>

GS9038



REPLACES / REEMPLAZA:

Infiniti / Nissan: 2373138U01, 2373138U11, 2373138U12, 237312Y000

APPLICATION / APLICACIÓN:

Infiniti: i30

Nissan: Maxima QX Mk4/Mk5

GS9052



REPLACES / REEMPLAZA:

Bosch: 0 232 103 052; **Ford:** 4M5G12K073AA, 1319158; **Alfa Romeo:** 55187973 / 112685; **Land Rover:** LR000634; **Volvo:** 30658182; **Meat & Doria:** 87413

APPLICATION / APLICACIÓN:

ALFA ROMEO: 159 1.9 JTS, 159 Sportwagon 1.9 JTS, 159 Sportwagon 2.2 JTS, Brera 2.2 JTS, Spider 2.2 JTS 2006->

FORD: Focus C-MAX 1.6 2004>2007, Focus 1.6 2004>, Mondeo 1.6 2007>

LAND ROVER: Range Rover Mk3 3.6/4.4 2006>2012, Range Rover IV 4.4 2012>, Range Rover Sport 3.6 2006>2013

VOLVO: C30 hatch 1.8/2.0 2006>2012, S40/S80 Mk2 1.8/2.0 2004>2010, V50 Estate 1.8/2.0 2004>2012, V70 Mk3 Estate 2.0 2007>2011

GS9053



REPLACES / REEMPLAZA:

Jeep: 5149034AA

APPLICATION / APLICACIÓN:

Jeep: Wrangler 2005>2006

GS9073



REPLACES / REEMPLAZA:

Ford: 1 111 037/ YS6A-12K073-AB; **Siemens/VDO:** 324 005 002R

APPLICATION / APLICACIÓN:

FORD: EcoSport 1.0 (Supercharger), 1.6 04>, Novo Fiesta 1.0, Supercharger, 1.6 Zetec RoCam 04>

GS9076



REPLACES / REEMPLAZA:

VW: 036.907.601.A, 036.907.601.B, 036.907.601.C, 036.907.601.D

APPLICATION / APLICACIÓN:

VW: Gol 1.0 8V (Power), Gol, Parati 1.0 16V Mi (Turbo) 02>, Gol, Parati 1.0 16V (Power) 02>

GS9079



REPLACES / REEMPLAZA:

Bosch: 0 232 103 079; **GM:** 12608424; **Cadillac:** 12608424; **Opel:** 04810352, 12608424; **Saab:** 12608424; **Suzuki:** 33220-78J10; **Meat & Doria:** 87924 | **Mobiletron:** CS-U041

APPLICATION / APLICACIÓN:

CADILLAC: CTS 2.8/3.6 2002>2007, CTS 3.0/3.6 2008>, CTS Coupe 3.6 2008>, SRX 3.6 2003-2009, STS 3.6 2004>2007

GM: Captiva 3.6 V6 2008>

OPEL: Antara 3.2 V6 2006>, Insignia Hatch/Saloon/Estate 2.8 V6 Turbo 4x4 2008>, Signum 2.8 V6 Turbo 2003>

SAAB: 9-3 Saloon/Cabrio/Estate 2.8 V6 Turbo 2002>2015

SUZUKI: Grand Vitara MK2 2.3 2005>



GS9093

REPLACES / REEMPLAZA:

Chevrolet / Cadillac: 12623093

APPLICATION / APLICACIÓN:

Chevrolet: Camaro, Corvette, Silverado

Cadillac: CTS, Escalade



GS9097

REPLACES / REEMPLAZA:

Bosch: 0 232 103 097; **Fiat:** K68070491A, K68070491AA, K68070491AB, 46798368, 46811121; **Lancia:** 55242637, 46811121, 46798368; **Jeep:** 68070 491AB, 55242 637; **Meat & Doria:** 87390

APPLICATION / APLICACIÓN:

Fiat: Bravo Mk2 hatch 1.4 2007>2014, Doblo MPV 1.4 2005->, Doblo Kombi 1.4 2010->, Idea MPV 1.2/1.4 16v 2004->, Linea 1.4 T-jet 2007->, Palio Weekend Estate 1.2 2001->, Punto 0.9 Twinair Turbo 2012->, Stilo hatch 1.2/1.4 16v 2002>2006, Tipo Saloon 1.4 2015->, 500 0.9 2007->

LANCIA: Delta Mk3 hatch 1.4 2008>2014, Musa 1.4 2004>2012, Y 1.2 16v 2000>2003, Ypsilon 1.2/1.4 2003>2011

JEEP: Compass 1.4 MultiAir 2017->, Renegade Closed Off-Road Vehicle 1.4 4x4 2014->



GS9099

REPLACES / REEMPLAZA:

Bosch: 0 232 103 002; **GM:** 90.449.573, 90.510.127; **Opel:** 1 238 999, 6 238 337

APPLICATION / APLICACIÓN:

GM: Calibra, Vectra GSI 2.0 16V 10/93>



GS9101

REPLACES / REEMPLAZA:

Bosch: 0232103015; **GM:** 90506101

APPLICATION / APLICACIÓN:

CHEVROLET: Astra 2.0 SFI 16V 1999>2005 Gasoline, Vectra 2.0 Flexpower 2005>2009 / 2.0 SFI 16V 1996>1997 Gasoline / 2.2 SFI 16V 1997>2005 Gasoline / 2.4 16V Flexpower 2005>2009 / Hatch 2.0 Flexpower 2007>2009, Zafira 2.0 SFI 16V 2001>2005 Gasoline, Zafira 2.0 1999>2005;

OPEL: Sintra 2.2i 16V 1996>1999, Speedster / VX220 2.0 Turb 2003>



GS9144 // NEW //

REPLACES / REEMPLAZA:

Bosch: 0 232 103 144; **Fiat:** 55247740

APPLICATION / APLICACIÓN:

FIAT: Argo HGT 1.8 2017>, Cronos HGT 1.8 2017>, Toro 1.8 2016>;

JEEP: Renegade 1.8 2015>



GS9196

REPLACES / REEMPLAZA:

Mitsubishi: MD360196

APPLICATION / APLICACIÓN:

Mitsubishi: Galant, Montero, Montero Sport



GS9226

REPLACES / REEMPLAZA:

Chevrolet: 91173944, 91174659, 91175909

Suzuki: 3322050G00, 3322050G01, 3322050G02

APPLICATION / APLICACIÓN:

Chevrolet: Metro, Tracker

Suzuki: Baleno, Grand Vitara, Ignis, Jimny, Wagon

**GS9230**

REPLACES / REEMPLAZA:

Ford: 6M8Z12K073AA, 6M8Z6B288B, 6M8Z6B288C**Mazda:** L3G118221, L3G218230, ZZCA18230, ZZCA18230A

APPLICATION / APLICACIÓN:

Mazda: 3 hatch, 5 MPV, 6 saloon, MX-5**Ford:** C-Max**GS9245**

REPLACES / REEMPLAZA:

GM: 12577245

APPLICATION / APLICACIÓN:

GM: Captiva 2.4/2.4 AWD 2011>, HHR 2.4 2007>2011**OPEL:** Astra J GTC 2.0 2012>, Antara 2.4/2.4 AWD 2010>, GT Convertible 2.0 2007->, Insignia Hatch/Saloon/Estate 2.0 Turbo/2.0 E85 Turbo/2.0 4x4 Turbo 2008>**SAAB:** 9-3 Saloon/Cabrio/Estate 2.0 T/2.0 T XWD/2.0 T Bio Power/2.0 T Bio Power XWD 2008>2015, 9-3X 2.0 T Bio Power XWD 2011>2012, 9-5 2.0 T/2.0 T XWD/2.0 T Bio Power/2.0 T Bio Power XWD**GS9266**

REPLACES / REEMPLAZA:

Cadillac / Opel: 12638266

APPLICATION / APLICACIÓN:

Cadillac: ATS, CTS**Opel:** Insignia**GS9288**

REPLACES / REEMPLAZA:

Ford: 1S7F12K073AD, 1S7Z6B288AA, 1119942**Mazda:** LF0118230, LF0118230Z06, 1F2018194

APPLICATION / APLICACIÓN:

Ford: C-Max, Fiesta, Focus, Mondeo, Transit**Mazda:** 3 hatch/saloon, 5 MPV, 6 hatch, Tribute**GS9292**

REPLACES / REEMPLAZA:

Lifam: 28083292

APPLICATION / APLICACIÓN:

Lifam: 520**GS9306**

REPLACES / REEMPLAZA:

Fiat: 46481306

APPLICATION / APLICACIÓN:

FIAT: Palio, Marea, Siena, Bravo, Stilo, Doblò 1.6 16V 1997>;**LANCIA:** Delta II 1.4/ 1.6 1993>1999, Lybra 1.6 1999>2005

GS9338 // NEW //

REPLACES / REEMPLAZA:

Honda: 37500-59BJ01

APPLICATION / APLICACIÓN:

HONDA: Civic X Hatchback 1.5 VTEC 2017>, CR-V 1.5/2.4 2017>

GS9399

REPLACES / REEMPLAZA:

Dodge: 5011853AA, 5080577AA, 5080577AB

APPLICATION / APLICACIÓN:

Dodge: Ram Pick Up 2500/3500

GS9471

REPLACES / REEMPLAZA:

Mazda: L3K918230, L3K918230A

APPLICATION / APLICACIÓN:

Mazda: 3 hatch, 5 MPV, 6 saloon, CX-7

GS9474

REPLACES / REEMPLAZA:

JMC: 28096004

APPLICATION / APLICACIÓN:

JMC: Landwind

GS9490

REPLACES / REEMPLAZA:

GM: 93363490

APPLICATION / APLICACIÓN:

GM: Corsa, Zafira, Montana 1.8, Meriva 1.8 2003>

FIAT: Stilo 1.8

GS9504 // NEW //

REPLACES / REEMPLAZA:

Bosch: F 01R 00B 003; **Chery:** A11-3611011; **Zotye:** 471Q-2L-3813801

APPLICATION / APLICACIÓN:

GEELY: CK Saloon 1.3 / 1.5 2005>;

BYD: F0 Hatchback 2009

GS9513



REPLACES / REEMPLAZA:
Nissan: 23731EN22A, 237313LM1A
 APPLICATION / APLICACIÓN:
Nissan: Qashqai, Tiida, X-trail, Sentra, NV200

GS9516



REPLACES / REEMPLAZA:
Kia: TN030-18516
 APPLICATION / APLICACIÓN:
Kia

GS9519



REPLACES / REEMPLAZA:
Chevrolet: 12576519, 12584070
 APPLICATION / APLICACIÓN:
Chevrolet: Colorado, Trailblzer

GS9536



REPLACES / REEMPLAZA:
Honda: 375105A2A01
 APPLICATION / APLICACIÓN:
Honda: Civic IX, CR-V, Jazz IV
Acura: ILX, TSX

GS9541



REPLACES / REEMPLAZA:
Isuzu: 10456541, 8104565410
 APPLICATION / APLICACIÓN:
Isuzu: Amigo, Rodeo, Trooper
Honda: Passport
Acura: SLX

GS9544



REPLACES / REEMPLAZA:
Chevrolet / Daewoo: 96253544
 APPLICATION / APLICACIÓN:
Chevrolet: Aveo, Lacetti, Rezzo
Daewoo: Nubira, Karlos, Tacuma

GS9601



REPLACES / REEMPLAZA:

VW: 030 907 601E

Mobiletron: CS-E112

Meat & Doria: 87281

APPLICATION / APLICACIÓN:

AUDI: A1 Sportback 1.2/1.4 TFSI 2011->, A2 hatch 1.6 FSI 2002>2005, A3 MK2 hatch 3-Door 1.2 TSI 2010>2012 / 1.4 TFSI 2007>2012 / 1.6 FSI 2003>2007, A3 MK2 hatch 5-Door 1.2 TSI 2010>2013 / 1.4 TFSI 2007>2013 / 1.6 FSI 2004>2007 / 3.2 V6 quattro 2004>2009, A3 convertible 1.2 TFSI 2010>2013, A8 MK2 Saloon 6.0 W2 quattro 2003>2010, Q7 3.6 FSI quattro 2006>2010, TT Coupe MK2 3.2 V6 quattro 2006>2010, TT Roadster Cabrio MK2 3.2 V6 quattro 2007>2010

SEAT: Alter MPV 1.4 TSI 2007->, Altea XL 1.4 TSI 2007->, Arosa Hatch 1.0/1.4 1997>2004, Cordoba MK1 Saloon/Estate 1.4/1.6 1994>2002, Ibiza MK2 hatch 1.4i 1993>2002, Ibiza MK4/MK5 hatch 1.2 2002>2009, Inca Van 1.4i 1995>2003, Leon MK1/MK2 hatch 1.2 1999>2012

SKODA: Fabia MK1 Hatch/Estate 1.2 2001>2008, Fabia MK2 Hatch/Estate 1.2/1.6 2007>2014, Octavia MK2 Hatch/Estate 1.2/1.4/1.6 2004>2013, Roomster MPV 1.2 TSI 2010>2015, SuperB MK2 1.4 TSI 2008>2015 / 3.6 FSI 4x4 2008>2015, Yeti 1.2/1.4 TSI 2009->

VOLKSWAGEN: Bora Saloon/Estate 1.4 16v 2000>2005, Golf MK4 Estate 1.4/1.6 2006>2015, Passat MK6 Saloon/Estate 1.4/1.6 2005>2010, Polo MK3 Hatch 1.0/1.4 1995>1999, Tiguan 1.4 TSI 4 motion 2007->, Touran 1.4/1.6 2003>2010

GS9616



REPLACES / REEMPLAZA:

BMW: 12141709616

VDO: S107230001, S107230001Z

APPLICATION / APLICACIÓN:

BMW: 3-Series Saloon 316i/318i 1993>1998, 3-Series Compact 316i/323ti 1997>2000, 3-Series Coupe 320i/323i/325i/328i 1992>1999, 3-Series Convertible 320i/323i/328i 1993>1999, 3-Series Estate 320i/323i/328i 1995>1999, 3-Series Saloon 316i/318i/320i/323i/325i/325xi/328i/330i/330xi 1998>2005, 3-Series Compact 325ti 2001>2005, 3-Series Coupe 316 Ci/318 Ci/320 Ci/323 Ci/325 Ci/328 Ci/330xi 1999>2006, 3-Series Convertible 320 Ci/323 Ci/325 Ci/330 Ci 2000>2007, 3-Series Estate 318i/320i/325i/325 xi/328i/330i/330 xi 1999>2005, 5-Series Saloon/Estate 520i/523i/525i/528i/530i 1995>2004, 5-Series Saloon 520i/525i/530i 2001>2010, 5-Series Estate 525i 2004>2010, 7-Series Saloon 728i/iL 1995>2001, 7-Series Saloon 730i/Li 2003>2008, X3 2.5i/3.0i xDrive 2004>2006, X5 3.0i 2000>2006, Z3 Roadster 1.9i/2.0i/2.2i/2.8i/3.0i 1997>2003, Z3 Coupe 2.8i/3.0i 1997>2003, Z4 Roadster 2.2i/2.5i/3.0i 2003>2005

GS9639 // NEW //



REPLACES / REEMPLAZA:

GM: 24579639

APPLICATION / APLICACIÓN:

GM: Ónix 2013>2018, Prisma 2013>2018, Cobalt 2016, Spin 2016>2018, Corsa 2015>2017, Celta 2014>2016, Montana 2015>2017

GS9667 // NEW //



REPLACES / REEMPLAZA:

Bosch: 0 281 002 667; **GM:** 93 347 211, 12628120, 25183414, 89052767, 91298691, 93342219; **Fiat:** 504 0482 61; **Iveco:** 0000504048261, 504048261, 5802260743, 80891268, 500382599; **New Holland:** 504048261, 5802260743, 82017881; **VW:** 2P0 133 491, 2R0919501B; **Citroën:** 1338F9; **Honda:** 37870PLZD00, 37870RBDE01; **Renault:** 5001848546, 5010412450, 7421531072, 7485137860; **Alfa Romeo:** 46472179; **Opel:** 1338179, 1338511, 4818227, 6235605, 6238935; **Volvo:** 93342220; **MTE:** 4005

APPLICATION / APLICACIÓN:

VW: Volksbus 5.140 EOD 2005;

FIAT: Ducato 2.8 JTD 4x4 Diesel 2002>, 2.8 JTD Diesel 2002>2006, JTD Power 2.8 Diesel 2004> IVECO: Daily III 4cc Diesel 1997>2009, Daily IV 4cc Diesel 2006>2012, Daily V 4cc Diesel 2011>2014, Daily VI 4cc Diesel 2014>, Daily Line 2014>, Daily Tourys 2014>, Massif Single Cab 3.0 4cc Diesel 2008>2011, Massif Pickup 2008>2011 3.0 4cc Diesel, Massif Station Wagon 3.0 4cc Diesel 2008>2011;

LDV: Maxus Minibus 2.5 4cc Diesel 2005>2009, Maxus Van 2.5 4cc Diesel 2005>2008, Maxus 2.5 4cc Diesel 2005>2008;

NEW HOLLAND: T4 (PowerStar) 2011>, T5 2011>

GS9683



REPLACES / REEMPLAZA:

Chevrolet: 12577683, 12598209

APPLICATION / APLICACIÓN:

Chevrolet: Equinox, Impala, Malibu, Monte Carlo



GS9692

REPLACES / REEMPLAZA:
GM: 24579692, 24581082
 APPLICATION / APLICACIÓN:
Chevrolet: S10 2.4 Flex 2013>



GS9702

REPLACES / REEMPLAZA:
VDO: S119702
 APPLICATION / APLICACIÓN:
NISSAN: Sentra, Livina, Tiida



GS9708

REPLACES / REEMPLAZA:
Chevrolet / Opel: 6235721, 55565708
 APPLICATION / APLICACIÓN:
Chevrolet: Aveo, Cruze, Orlando, Trax
Opel: Astra J, Corsa D, Insigniam Zafira



GS9709 // NEW //

REPLACES / REEMPLAZA:
GM: 25195556
 APPLICATION / APLICACIÓN:
GM: Aveo hatch 1.4 2008>, Cruze 1.6/1.8 2009>, Orlando 1.8 2011>, Trax 1.6/1.8 2012>;
Opel: Astra J 1.6 2009>, Corsa D hatch/saloon 1.0 2010>, Insigniam hatch/saloon 1.6/1.8 2008>, Zafira Tourer 1.8 2011>



GS9725

REPLACES / REEMPLAZA:
Chrysler / Dodge: 5149078AA, 5149078AB, 5149078AC, 5149078AD
 APPLICATION / APLICACIÓN:
Chrysler: Pacifica, Town e Country
Dodge: Grand Caravan



GS9867 // NEW //

REPLACES / REEMPLAZA:
GM: 96325867; **Mobiletron:** CS-E131
 APPLICATION / APLICACIÓN:
GM: Spark 1.0 2010>, Aveo 1.4 2003>2008, Laceti 1.4 2005>, Matiz 0.8/1.0 2005>2007;
DAEWOO: Matiz 0.8 1998>, Kalos 1.2/1.4 2003, Lacetti 1.4 2004

GS9886



REPLACES / REEMPLAZA:

Renault: 8200963886, 8200681385

APPLICATION / APLICACIÓN:

RENAULT: Captur 0.9 TCe 90/1.2 TCe 120/1.5 dCi 90 13>, Clio Mk2 Hatch 1.5 dCi 2004>, Clio Mk3 Hatch 1.2 16V/1.6 16V/ 1.5 dCi 2005>, Clio Mk3 Estate 1.2 16V/1.6 16V/ 1.5 dCi 2008>, Clio IV 0.9 TCe 90/1.2 TCe 120/1.5 dCi 75/90 20112>, Clio IV Grandtour 0.9 TCe 90/1.2 TCe 120/1.5 dCi 75/90 2013>, Fluence 1.6 16V/ 1.5 dCi 2010>, Kangoo Mk1/Mk1 Van 1.5 dCi 2001>, Kangoo Mk2/Mk2 Van 1.2 TCe 115/1.5 dCi 2008>, Kangoo Be Bop 1.5 dCi 2009>, Laguna Mk3 Hatch/Estate 1.6 16V/1.5 dCi 2007>, Laguna Mk3 Coupe 1.5 dCi 2012>, Latitude 1.5 dCi 2010->, Logan I 1.5 dCi 2007>, Logan I Estate 1.5 dCi 2007>, Mégane III Hatchback/Grandtour/Coupe/CC 1.2 TCe/1.6 16V/2.0 TCe/1.5 dCi/1.6 dCi 2008>, Modus Hatch 1.2/1.6/1.5 dCi 2004>, Scénic III/Grand Scénic III 1.2 TCe/1.6 16V/1.5 dCi/1.6 dCi 2009>, Thalia I 1.5 dCi 2002>, Thalia II 1.5 dCi 2008>, Twingo Mk2 Hatch 1.6 RS/1.5 dCi 2007>, Wind 1.6 2010>

GS9990



REPLACES / REEMPLAZA:

Changan: 3781020-02

APPLICATION / APLICACIÓN:

Changan: Star, Benni 474

GS9991



REPLACES / REEMPLAZA:

Honda: 37840-PLC-000, 37840-PLC-006, 37840-RJH-006;

Denso: J5T23991, J5T23992

APPLICATION / APLICACIÓN:

Honda: Civic 2001>2006



EMS COMPONENTS | SISTEMA DE CONTROL DE MOTOR

THROTTLE P. SENSOR | SENSOR DE P. DE LA MARIPOSA

GS7006

REPLACES / REEMPLAZA:
Honda: JT6H, 16400PLRA01, 16402-RAC-A01, 16402-RAA-A01
APPLICATION / APLICACIÓN:
HONDA: Civic 1.7 2001>2005, CR-V EX Sport Utility 2.4 2002>2006

GS7010

REPLACES / REEMPLAZA:
Toyota: 894520A010
APPLICATION / APLICACIÓN:
TOYOTA: Avensis Verso MPV 2.0 2001>2009, Camry Saloon 2.2/3.0 1996>2001, Camry Saloon 3.0 2001>2006, Corolla Hatch/Saloon/Estate 1.6 Aut./1.6 1997>2000, Rav 4 Mk1 2.0 4WD 1994>2000, Rav 4 Mk1 Cabrio 2.0 16V 4WD 1997>2000, Rav 4 Mk2 2.0 4WD 2000>2005, Rav 4 Mk3 2.0 VVT-i 4WD 2006->
LEXUS: ES 300 1991>1997, RX Mk1 300 AWD 2000>2003, RX Mk2 300 2003>2008

GS7020 // NEW //

REPLACES / REEMPLAZA:
Hyundai: 35102-02010, 3510202000; **MTE:** 7281
APPLICATION / APLICACIÓN:
HYUNDAI: Atos 1.0 2000>2004

GS7610 // NEW //

REPLACES / REEMPLAZA:
Hyundai: 35102-38610; **Mobileron:** TP-K002;
Delphi: SS10999-12B1
APPLICATION / APLICACIÓN:
HYUNDAI: HIGHWAY VAN 2000>2004, SANTA FÉ I (SM) 2000>2006, SONATA IV (EF) 1998>2005, TRAJET (FO) 2000>2008;
KIA: MAGENTIS (GD, MS) >2001

GS7301

REPLACES / REEMPLAZA:
Bosch: 0 280 122 001; **Fiat:** 7 637 025; **KIA:** 0K011-18-911, 0K247-18-911, 0K30A-18-911
APPLICATION / APLICACIÓN:
ASIA: Townner Todos;
FIAT: Elba CSL 1.6 (MPI) Todos, Marea 2.0i 20V, Marea 2.0i 20V Turbo 98 >, Marea Weekend 2.0i 20V 98 >, Marea Weekend 2.0i 20V Turbo 98 >, Pick-up LX (MPI) Todos, Tempra Turbo 94 >, Tipo 1.6 (MPI) 95 >, Uno 1.6 (MPI) Todos;
GM: Astra 1.8i, 2.0i 98 >, Astra 2.0i 16V 99 >, Blazer 2.4 (MPFI), S10 2.4 (MPFI) 00 >, Ipanema 2.0 (MPFI), Kadett 2.0 (MPFI) 97 >, Omega CD 3.0, Omega GLS 2.0 92 >, Omega CD 4.1, Suprema CD 4.1 94 >, Pick-up C20 4.1, Silverado 4.1 96 >, Suprema CD 3.0, GLS 2.0 92 >, Vectra 2.2i 16V 97 >, Vectra CD 2.0 16V 96 >, Vectra CD 2.0 8V (MPFI) 93 > 96, Vectra GLS 2.0 (MPFI), GSI 2.0 16V 93 >;
PEUGEOT: 306 1.8 97 >

GS7387

REPLACES / REEMPLAZA:
VW: 037 907 385Q
APPLICATION / APLICACIÓN:
RENAULT: Mégane 1.6 8V (MPFI) All;
SEAT: Cordoba, Ibiza 2.0 16V 96>99;
VW: Golf 2.0 GTI 16V 92>99, Passat 2.0 16V 94>96

GS7302

REPLACES / REEMPLAZA:
Magneti Marelli: 404 430 02
APPLICATION / APLICACIÓN:
FIAT: Palio, Siena, Weekend, Uno 1.0 8V 99 > 02, Brava, Doblò, Palio 1.6 16V 00 >, Fiorino, Weekend, Strada, Uno, Palio 1.5 MPI 99 >, Fiorino, Weekend, Palio, Siena, Uno 1.0 e 1.3 Fire MPI 01 >

GS7306

REPLACES / REEMPLAZA:
Bosch: 3 437 020 406, 3 437 020 417
APPLICATION / APLICACIÓN:
FIAT: Tipo 1.6 ie 92>96;
PEUGEOT: 106 1.0/1.6 8V All;
RENAULT: Clio, R19 1.6/1.8 (SPI) 95>96;
VW: Golf GL 1.8 (monoponto) >96

GS7322

REPLACES / REEMPLAZA:
Original code: 17 106 682, 93 214 087; **Delphi:** ICD00122
APPLICATION / APLICACIÓN:
GM: Blazer, S10 2.2 (EFI) 91>96, Corsa 1.0/1.4/1.6 (EFI) 91>, Ipanema, Kadett, Monza 1.8/2.0 (EFI) 91>96

GS7372

REPLACES / REEMPLAZA:
GM: 25 178 872, 17 097 102; **Delphi:** ICD00123
APPLICATION / APLICACIÓN:
GM: Celta 1.0/1.4 (MPFI) 01>, Corsa 1.0/1.6 (MPFI) 96>, Omega, Suprema 2.2 (MPFI) 97 >;

GS7653 // NEW //



REPLACES / REEMPLAZA:
GM: 17087653, 825482; **MTE:** 7231;
Mobiletron: TP-E002;
Delphi: SS10425-11B1, SS10425-12B1
APPLICATION / APLICACIÓN:
BUICK: CENTURY Stufenheck 1981>1996;
CADILLAC: FLEETWOOD Stufenheck 1988>1993;
GM: AVEO / KALOS Schrägheck (T200) 2003>2008, BERETTA Coupe (1_37) 1987>1996, CAMARO 1992, CAVALIER Stufenheck 1991>1996

GS7385



REPLACES / REEMPLAZA:
VW: 021 907 385
APPLICATION / APLICACIÓN:
VW: Kombi 1.6 (Mi) 97 > 04

GS7386



REPLACES / REEMPLAZA:
VW: 044 907 385A
APPLICATION / APLICACIÓN:
VW: Golf 1.8 Mi 94 > 98, Passat Alemão 2.0 95 > 98, Polo Classic 01 >;

GS7456 // NEW //



REPLACES / REEMPLAZA:
BMW: 13631721456; **Meat & Doria:** 83088
APPLICATION / APLICACIÓN:
BMW: 3-Series Saloon 1982>1998, 3-Series Compact 1994>2000, 3-Series Coupe 19991>1999, 3-Series Convertible 1993>1999, 3-Series Estate 1994>1999, 5-Series Saloon 1987>2003, 5-Series Estate 1991>2004, 7-Series Saloon 1986>2001, 8-Series Coupe 1990>1999, Z3 Roadster 1995>2003, Z3 Coupe 1997>2003

GS7389



REPLACES / REEMPLAZA:
Magneti Marelli: 404 062 02; **Fiat:** 7077710, 9945634;
Delphi: SS10689
APPLICATION / APLICACIÓN:
FIAT: Tempra 2.0 16V (MPI - gasoline) 95>, Palio, Weekend, Siena 1.6 16V (MPI) 96>99, Brava 1.6 16V 99>;
RENAULT: Clio, Mégane, Scénic 1.6 16V 99>



GS7393

REPLACES / REEMPLAZA:
VW: 026 998 385 1; **Magneti Marelli:** 404 217 02;
Renault: 7702217302; **Ford:** 0269983851; **Fiat:** 7076359;
Delphi: SS10693
APPLICATION / APLICACIÓN:
FIAT: Elba, Fiorino (SPI), Fiorino (MPI), Palio (SPI), Palio 8V (MPI), Prêmio, Tempra (SPI), Uno (SPI) All , Palio Weekend 1.5, Strada 1.5, Uno Mille (MPI) 99 > ;
FORD: Escort 97 > , Pampa, Royale, Verona, Versailles All ;
RENAULT: Clio 1.6 (SPI) 97>, R19 1.6 (SPI) 96>;
VW: Gol, Parati SPI (gasoline) 95 >, Gol 2.0 MPI 94 >, Logus 1.8 (SPI), Logus 2.0 (MPI) Todos, Pointer 1.8 (SPI), Pointer 2.0 (MPI) 95>, Quantum 1.8 (SPI), Quantum 2.0 (MPI) 95>, Santana 1.8 (SPI), Santana 2.0 (MPI) 95>

GS7352



REPLACES / REEMPLAZA:
GM: 17 123 852; **Delphi:** ICD00001
APPLICATION / APLICACIÓN:
GM: Blazer, S10 4.3 V6 97>



GS7391

REPLACES / REEMPLAZA:
Ford: 95BF9B989JB
APPLICATION / APLICACIÓN:
FORD: Courier, Ka, Fiesta Zetec Rocam 1.0, 1.6 99 >, Courier, Ka, Fiesta Endura 1.0 e 1.3 97 > 99, Courier, Fiesta Zetec-SE 1.4L 16V 96 > 99, Escort Zetec Rocam 1.0, 1.6 00 > 02..

GS7392



REPLACES / REEMPLAZA:
Magneti Marelli: 404 160 02; **Delphi:** SS10692; **VW:** 0279983851
APPLICATION / APLICACIÓN:
VW: Gol/ Parati 2.0 16v >97, Logus, Pointer 2.0 94 > 95, Santana, Quantum SPI 93 > 95, Gol 1.0 SPI 95 > 97.



GS7351

REPLACES / REEMPLAZA:
VW: 027 998385 1; **Magneti Marelli:** 404 159 02
APPLICATION / APLICACIÓN:
SEAT: Inca 1.6 (Mi - gasoline) 98>;
VW: Gol, Parati, Saveiro 1.6/1.8/2.0 (MPI - alcohol/gasoline) 96>, Polo Classic 1.8 (MPI - gasoline) 96 >, Quantum, Santana, Saveiro 1.8/2.0 (MPI - alcohol/gasoline) 96>, Saveiro / Van 1.6 (MPI - gasoline) 98 >.

GS7401 // NEW //

REPLACES / REEMPLAZA:
Daihatsu: 89452-87Z01, 89452-97401;

Toyota: 89452-87Z01, 89452-97401; **Meat & Doria:** 83158

APPLICATION / APLICACIÓN:
DAIHATSU: Copen Cabrio 1.3 2006>2012, Extol Van 1.3 2000>2011, Materia 1.3 2006>, Materia 1.5 2006>, Materia 1.5 ECO 4WD 2006>, Sirion Hatch 1.3 2005>, Sirion Hatch 1.3 4WD 2005>, Sirion Hatch 1.5 2008>, Terios 1.3 2001>2005, Terios 1.3 4WD 2000>2005, Terios 1.3 VVT-i 4x4 2005>, Terios 1.3 VVT-i RWD 2005>, YRV Estate 1.3 2001>

GS7600
REPLACES / REEMPLAZA:
Hyundai / Kia: 35170-22600;

Chevrolet: 91 173 884, 91 174 211, 91 176 136, 91 177 706;

Nissan: 22620 1F700; **SAAB:** 09181538; **Opel:** 90530439, 90541502; **MEAT & DORIA:** 83045;

MOBILETRON: TP-E006

APPLICATION / APLICACIÓN:
HYUNDAI: Accent Mk2 Hatch/Saloon 1.3/1.5/1.6 2000>2005, Coupe Mk1 1.6i 16V 1996>2002, Coupe Mk2 1.6 16V/2.0/2.0 GLS 2001>2009, Elantra Mk3 Hatch/Saloon 1.6/1.8/2.0 2000>2006, Getz Hatch 1.1/1.3/1.6 2002>2005, Matrix MPV 1.6/1.8 2001>2010, Sonata Mk5 2.0 VVTi GLS 2005>2010, Trajet 2.0 2004>2008, Tucson 2.0 2004>2010;

KIA: Cerato Saloon/Hatch 1.6/2.0 2004>, Sportage MK2 SUV 2.0i 16V 2004>;

NISSAN: Micra M k2 1992>2007;

OPEL: Astra G hatch 1.2 16V 1998>2000 / 2.0 16V 1998>2005, 2.0 16V OPC 1999>2002, Astra G Saloon 1.2 16V 1998>2000 / 2.0 16V 1998>2005, Astra G Estate 1.2 16V 1998>2000 / 2.0 16V 1998>2004, Astra G Coupe 2.0 16V Turbo 2000>2005, Astra G convertible 2.0 OPC / 2.0 16V Turbo, Corsa B hatch 1.0i 1996>2000, 1.2i 16V 1998>2000, Omega B Saloon 2.5 V6 1994>2000 / 3.0 V6 1994>2001, Omega B Estate 2.5 V6 1994>2000 / 3.0 V6 1994>2001, Vectra B hatch 2.5i V6 1995>2000 / 2.5 1999>2000, Vectra B Saloon 2.5i V6 1995>2000 / i500 2.5 1998>2000, Vectra B Estate 2.5i V6 1996>2000 / i500 2.5 1998>2000;

SAAB: 9-3 hatch 2.0i 1998>2002, 900 Mk2 hatch 2.0i 1994>1998

GS7788 // NEW //

REPLACES / REEMPLAZA:
Delphi: SS10788;

CHEVROLET: 93356162, 98500113

APPLICATION / APLICACIÓN:
FIAT: Dobló, Idea, Palio, Punto, Siena, Stilo, Strada - All 1.8 8V Flex 06>09;

CHEVROLET: Corsa, Montana - Ambos 1.4/1.8 8V Flex 06>09, Meriva 1.8 8V Flex 06>09

GS7881
REPLACES / REEMPLAZA:
Delphi: SS10881

APPLICATION / APLICACIÓN:
FIAT: Dobló, Idea, Palio, Punto, Siena, Stilo, Strada - All 1.8 8V Flex 06>09;

GM: Corsa 1.4/1.8 8V Flex 06>09, Montana 1.4/1.8 8V Flex 06>10, Meriva 1.8 8V Flex 06>12

GS7882

REPLACES / REEMPLAZA:
Delphi: SS10882

APPLICATION / APLICACIÓN:
GM: Celta, Corsa - 1.0 8V Flex 11>15, Prisma 1.0 8V Flex 11>13

GS7883
REPLACES / REEMPLAZA:
Delphi: SS10883

APPLICATION / APLICACIÓN:
GM: Corsa, Montana - 1.4/ 1.8 8V Flex/Gasolina 10>12, Meriva 1.8 8V Flex/Gasolina 10>12

GS7889

REPLACES / REEMPLAZA:
Ford: F37F9B989BA, F07Z9B989BA, 988F9B989BB; **MEAT & DORIA:** 83098; **MOBILETRON:** TP-U001

APPLICATION / APLICACIÓN:
FORD: Cougar Coupe 2.0 16V 1998>2001, Fiesta Mk4 Hatch 1.25i 16V 1995>2002, Fiesta Mk6 Hatch 1.25 16V/1.3 2001>2008, Fiesta Mk6 Van 1.3 2003>2005, Fiesta Courier Mk4 Van 1.3 1996>2003, Focus Mk1 Hatch/Saloon/Estate 1.4 16V/1.6 16V/ 1.8 16V/2.0 16V/ST170 1998>2004, Ka 1.3i/1.6i 1996>2003, Maverick Mk2 2.0 16V/2.3 16V 2001->, Mondeo Mk2 Hatch/Saloon/Estate 1.6i/1.6i 16V/1.8i/2.0i/2.5 24V/2.5 ST 200 1996>2000, Mondeo Mk3 Hatch/Saloon/Estate 1.8 16V/2.0 16V/2.5 V6 24V 2000>2007, Puma Coupe 1.6 16V 2000>2002, Street Ka Convertible 1.6 2003>2005, Tourneo Connect MPV 1.8 16V 2002>2013, Transit Connect 1.8 16V 2002>2013

GS7910
REPLACES / REEMPLAZA:
Hyundai / Kia: 35170-26910

APPLICATION / APLICACIÓN:
HYUNDAI: i10 Hatch 1.2 2008>2013, i20 1.2/1.4 2008>2015, i30 Hatch/Estate 1.4/1.6/2.0 2007>2012, Elantra 1.5 i.e. 1990>1995;

KIA: Carens Mk3 1.6 CVVT 2009>, Cee'd Hatch 1.4/1.4 CVVT/1.6/1.6 CVVT/2.0 2006>2012, Cee'd Estate 1.6 2007>2012, Pro Cee'd Hatch

1.4/1.6/2.0 2008>2012, Cerato Hatch/Saloon 1.6 2004>, Soul 1.6 CVVT 2009>

GS7989



REPLACES / REEMPLAZA:

FORD: 95BF9B989DA

APPLICATION / APLICACIÓN:

FORD: Cougar Coupe 2.0 16V 98>01, Escort Mk7 Hatch/Saloon/Estate/Convertible 1.6 16V/1.8 16V 95>99, Focus Mk1 Hatch RS 02>04, Galaxy Mk1 2.0i/2.3 16V 95>06, Mondeo Mk1 Hatch/Saloon/Estate 1.8i 16V 93>96, Mondeo Mk2 Hatch/Saloon/Estate 1.6i/1.8i/2.0i 16V 96>00, Scorpio Mk2 Saloon/Estate 2.3i 16V 96>98, Transit Mk6 Minibus/Van/Flatbed 2.3 16V 00>06



EMS COMPONENTS | SISTEMA DE CONTROL DE MOTOR

SPEED SENSOR | SENSOR DE VELOCIDAD



GS1000

REPLACES / REEMPLAZA:

Nissan: 31935 X420A, 31935 1XF00, 31935 8E003, 31935 8E005, 31935 8E007

Renault: 31935-1XF00

APPLICATION / APLICACIÓN:

NISSAN: Cube, Juke, Micra, Murano

RENAULT: Fluence, Koleos, Megane, Scenic



GS1003

REPLACES / REEMPLAZA:

Honda: 78410-SAA-003

APPLICATION / APLICACIÓN:

HONDA: Jazz Mk2 Hatch 1.2/1.3 2002>2008



GS1004

FEATURES / CARACTERÍSTICAS: **8 PULSE. Equal to GS1013 (4 pulse)**

REPLACES / REEMPLAZA:

Hyundai / Kia: 96420M3000, 964204A000, 964204A500, 964204A600

APPLICATION / APLICACIÓN:

HYUNDAI: Elantra, Sonata, Santa Fé

KIA: Pride, Cerato, Carens, Picanto, Soul



GS1007

REPLACES / REEMPLAZA:

NISSAN: 319358E007

APPLICATION / APLICACIÓN:

NISSAN: Cube 1.6 16V 2007>, Juke 1.6 2010>, Micra C+C Convertible 1.6 160 SR 2005>, Micra IV 1.2 2010>, Murano II 3.5 4x4 2007>2014, Note 1.6 2005>2012, Note 1.2 2013>, Qashqai 1.6/2.0 2007>2013, Tiida Saloon 1.6 2004>2013, Tiida Hatchback 1.6 2004>2013, X-Trail 2.0/2.5 2007>2014



GS1009

REPLACES / REEMPLAZA:

VW: 5Z0919149, 6Q0919149A;

VDO: 324003009R

APPLICATION / APLICACIÓN:

AUDI: A2 Hatch 1.4/1.6 FSI 2000>2005;

SEAT: Cordoba Mk2 Saloon 2002>2009, Ibiza Mk4 Hatch 2002>2009;

SKODA: Fabia Mk1 Hatch 1.0/1.2/1.4/1.9/2.0 1999>2008, Fabia Mk1 Saloon 1.2/1.4/ 1.9/2.0 1999>2007, Fabia Mk1 Estate 1.2/1.4/1.9/2.0 2000>2007, Fabia Mk1 Van 1.2/1.4/1.9 2001>2007, Fabia Mk2 Hatch 1.2/1.4/1.6/1.9 2006>2014, Fabia Mk2 Estate 1.2/1.4/1.6/1.9 2007>2014, Rapid/Rapid Spaceback 1.2/1.4/1.6 2012>2015;

Roomster MPV 1.2/1.4/1.6/1.9 2006>2015, Praktik Van 1.2/1.4/1.6 2007>2015;

VW: Bora Saloon/Estate 1.6 FSI 2002>2005, Fox Hatch 1.2/1.4 2005>, Golf Mk4 Hatch/Estate 1.6 FSI 2002>2005, Golf Mk5 Hatch 1.4/1.6/1.9/2.0 2003>2008, Golf Mk5 Plus 1.2/1.4/1.6/1.9/2.0 2005>2013, Lupo Hatch 1.6 GTI 2000>2005, New Beetle 1.4 2001>2010, New Beetle Convertible 1.4 2003>2010, Polo Mk4/4F Hatch 1.2/1.4/1.6/1.8/1.9 2001>2009, Polo Mk4 Saloon 1.4/1.9 2002>



GS1013

FEATURES / CARACTERÍSTICAS: **4 PULSE**

REPLACES / REEMPLAZA:

Hyundai / Kia: 96420M3000, 964204A000, 964204A500, 964204A600

APPLICATION / APLICACIÓN:

HYUNDAI: Elantra, Sonata, Santa Fé

KIA: Pride, Cerato, Carens, Picanto, Soul

GS1042 // NEW //

REPLACES / REEMPLAZA:

Fiat: 46744042

APPLICATION / APLICACIÓN:

FIAT: Tempra 2.0 1994>1997, Brava 1.6 16V 2000>2003, Marea Weekend 1.6 MPI 16V 2004->, Marea Weekend 2.0/2.4 20V 1999>2007

GS1061

REPLACES / REEMPLAZA:

Dodge: 4799061AB, 4799061

APPLICATION / APLICACIÓN:

DODGE: Nitro, Dakota, Durango, Ram 1500/2500

GS1063

REPLACES / REEMPLAZA:

Peugeot: 2576063, 616070

APPLICATION / APLICACIÓN:

Peugeot: 206, 306, 307 1.0 / 1.6 / 1.8 / 2.0, 206 1.4 and 1.6 16V;

Citroën: C3, C5, Berlingo, Xsara Picasso

GS1072 // NEW //

REPLACES / REEMPLAZA:

Mitsubishi: G4T08072

APPLICATION / APLICACIÓN:

MITSUBISHI: L200 2.5 2006>2010, Montero Sport 2.5/3.2, Pajero Shogun 2.5 2000>2010, Pajero Mk3 3.2

GS1082

REPLACES / REEMPLAZA:

GM: 90149082

APPLICATION / APLICACIÓN:

CHEVROLET: Kadett/Ipanema SL/SLE/GL/GLS 1.8/1.8 EFI 1989>1997, Kadett 2.0 GSI 8V 1991>1997, Ipanema 2.0 MPFI 1989>1997

GS1103

REPLACES / REEMPLAZA:

Ford: 6E5Z-7H103-A

APPLICATION / APLICACIÓN:

FORD: Fusion 2.3 2006>2009, MKZ 3.5 V6 2007>2009, Milan 2.3 2006>2009

MAZDA: Mazda 2 2011>2014, Mazda 3 2004>2013, Mazda 5 2006>2014, Mazda 6 2003>2013, CX-7 2010>2012, MX-5 Miata 2006>2008, Protege 1999>2003, Protege 5 2002>2002

GS1129

REPLACES / REEMPLAZA:

VW / Audi / Seat / Skoda: 1J0919149A

APPLICATION / APLICACIÓN:

VW: Bora, Golf

AUDI: A3, TT

SEAT: Toledo II, Cordoba

SKODA: Octavia

GS1149



REPLACES / REEMPLAZA:

Audi/VW: 1H0 919 149 C

APPLICATION / APLICACIÓN:

AUDI: A3;

VW: Golf, Polo, Golf Mexicano, Bora, Caddy;

Seat: Cordoba, Ibiza

GS1191



REPLACES / REEMPLAZA:

VW: 012 409 191D

APPLICATION / APLICACIÓN:

ALFA ROMEO: 145 Hatch 1.6 94>01;

AUDI: A4 Mk1 Saloon/Avant/Estate 1.6/1.8/1.9/2.4/2.5/2.6/2.8/S4 1994>2000, A4 Mk2 Saloon/Avant/Estate 1.6/1.8/1.9/2.0/2.4/2.5/3.0 2000>2004, A6 Mk2 Saloon/

Avant/Estate 1.8/1.9/2.0/2.4/2.5/2.7/2.8/3.0/3.7/4.2/S6 1997>2005, A8 Mk1 Saloon 2.5/2.8 1994>2002, Cabriolet 1.8/1.9/2.0/2.3/2.6/2.8 1991>2000;

SKODA: Superb Mk1 Saloon 1.8/1.9/2.0/2.5/2.8/ 2001>2008;

VW: Passat Mk5 Saloon/Estate 1.6/1.8/1.9/2.0/2.3/2.5/2.8 1996>2005

GS1220 // NEW //



REPLACES / REEMPLAZA:

Fiat: 46744220

APPLICATION / APLICACIÓN:

FIAT: Marea / Marea Weekend 1.8 2000>2005, Brava 1.8 16V 2000>2003

GS1227 // NEW //



REPLACES / REEMPLAZA:

VW: 547957827

APPLICATION / APLICACIÓN:

VOLKSWAGEN: Apollo 1.8/2.0 1994>1996, Logus 1.6/1.8 CFI/2.0 Digital 1994>1996, Gol 1.0/1.6/1.8 CFI 1994>1997, Parati 1.6/1.8 CFI 1994>1997, Pointer 1.8 CFI/2.0 Digital 1994>1997

GS1231



REPLACES / REEMPLAZA:

Ford: 1S65-9E731-AC, 1S65-9E731-AD

APPLICATION / APLICACIÓN:

FORD: Fiesta Street, Courier

GS1234



REPLACES / REEMPLAZA:

Honda: 28810PPW013

APPLICATION / APLICACIÓN:

HONDA: Accord 2003>2005

GS1244



REPLACES / REEMPLAZA:

Fiat: 46744244

APPLICATION / APLICACIÓN:

FIAT: Palio Weekend Estate 1.6 16V 1996>2001, Strada Pickup 1.7 TD 1999>2006

GS1249



REPLACES / REEMPLAZA:

VW: 1H0 919 149 A

APPLICATION / APLICACIÓN:

AUDI: A3 Mk1 Hatch 1.6/1.8/1.9 1996>2003, TT Coupe Mk1 1.8/3.2 1998>2006;

SEAT: Cordoba Mk1 Saloon 1.6/1.8/1.9/2.0 1993>1999, Cordoba Estate 1.6/1.9 1996>1999, Ibiza Mk2 Hatch 1.6/1.8/1.9/2.0 1993>1999, Inca Van 1.6/1.7/1.9 1995>2003;

SKODA: Octavia Mk1 Hatch/Estate 1.4/1.6/1.8/1.9/2.0 1996>2010;

VW: Bora Saloon/Estate 1.4/1.6/1.8/1.9/2.0/2.3/2.8 1998>2005, Caddy Mk2 Estate/Van 1.6/1.9 1995>2004, Golf Mk3 Hatch/Estate 1.4/1.6/1.8/1.9/2.0 1991>1999, Golf Mk4 Hatch/Estate 1.4/1.6/1.8/1.9/2.0/2.3/2.8 1997>2006, Polo Classic Mk3 Saloon 1.6/1.7/1.9 1995>1997, Polo Mk3 Estate 1.6/1.7/1.9 1997>2001, Vento 1.4/1.6/1.8/1.9/2.0 1991>1998

GS1283



REPLACES / REEMPLAZA:

Renault: 8200547283

APPLICATION / APLICACIÓN:

RENAULT: Clio 1.0/1.6 16V Flex 04>, Kangoo 1.6 16V Flex 07>, Logan/Sandero 1.0 16V 08>, 1.6 8/16V 08>, Mégane 1.6 16V Flex 07>, Scénic 1.6 16V Flex 05>

GS1292



REPLACES / REEMPLAZA:

Chevrolet: 88893292

APPLICATION / APLICACIÓN:

CHEVROLET: Cavalier, Cobalt, HHR

GS1321



REPLACES / REEMPLAZA:

VW: 01M 927 321B

APPLICATION / APLICACIÓN:

AUDI: A3 Mk1 Hatch 1996>2003

SEAT: Leon Mk1 Hatch 1.6/1.8/1.9 1999>2006, Toledo Mk2 Saloon 1.6/1.8/1.9 1998>2004

SKODA: Octavia Mk1 Hatch/Estate 1.6/1.8/1.9/2.0 1996>2010

VW: Bora Saloon/Estate 1.6/1.8/1.9/2.0/2.3 1998>2005, Golf Mk4 Hatch/Estate 1.6/1.8/1.9/2.0/2.3 1997>2006, New Beetle 1.6/1.8/1.9/2.0 1998>2010, New Beetle Convertible 1.6/1.8/2.0 2002>2010

GS1325



REPLACES / REEMPLAZA:

Ford: 6L8Z7H103AA, 6L8P7H103AA, F8RP7H103AA

APPLICATION / APLICACIÓN:

FORD: Cougar, Maverick, Mondeo

MAZDA: Tribute

GS1331



REPLACES / REEMPLAZA:

Ford: 2S65-9E731-AD

APPLICATION / APLICACIÓN:

FORD: Fiesta Amanzo 2003>2012, Ecosport >2012, Ford Ka >2013, Fiesta Rocam >2014



GS1349

REPLACES / REEMPLAZA:

VW: 357919149B

APPLICATION / APLICACIÓN:

AUDI: A3 Mk1 Hatch 1.6/1.8/1.9/S3 1996>2003;

SEAT: Arosa Hatch 1.0/1.4/1.7 1997>2004, Cordoba Mk1 Hatch/Estate 1.0/1.4/1.6/1.8/ 1.9 1999>2002, Cordoba Mk2 Saloon 1.2/1.4/1.6/1.9/2.0 2002>2009, Ibiza Mk3 Hatch 1.0/1.4/1.6/1.8/1.9 1999>2002, Ibiza Mk4 Hatch 1.2/1.4/1.6/1.8/1.9/2.0 2002>2009, Inca Van 1.4/1.7/1.9 1995>2003, Leon Mk1 Hatch 1.4/1.6/1.8/1.9/2.8 1999>2006,

Toledo Mk2 Saloon 1.4/1.6/1.8/1.9/2.8 1998>2006;

SKODA: Fabia Mk1 Hatch/Saloon/Estate 1.0/1.4 1999>2008, Octavia Mk1 Hatch /Estate 1.4/1.6/1.8/1.9/2.0 1996>2010;

VW: Bora Saloon/Estate 1.4/1.6/1.8/1.9/2.0/2.3/2.8 1998>2005, Caddy Mk2 Estate/Van 1.4/1.9 1995>2004, Golf Mk4 Hatch/Estate 1.4/1.6/1.8/1.9/2.0/2.3/2.8/3.2 1997>2005, Lupo Hatch 1.0/1.2/1.4/1.6/1.7 1998>2005, New Beetle 1.9/2.0 1998>2010, New Beetle Convertible 1.8/2.0 2002>2010, Polo Mk3F Hatch 1.0/1.4/1.6/1.7/1.9 1999>2001, Polo Mk4/4F Hatch 1.2/1.4/1.6/1.8/1.9 2001>2012, Polo Mk4 Saloon 2002>



GS1374

REPLACES / REEMPLAZA:

Fiat: 46817374

APPLICATION / APLICACIÓN:

Fiat: Palio, Siena 1.0, 1.3, 1.6, 1.8 MPI 8/16V / Fire Gas. 01>04, Palio 1.5 MPI 05>, Brava 1.6 MPI 16V, Doblo 1.3, 1.6, 1.8 Fire MPI 02>05, Marea 2.0, 2.4 MPI 20V Gas. 99>03, Panda, Barcheta, Punto



GS1431

REPLACES / REEMPLAZA:

Ford: F85Z-9E731-AB

APPLICATION / APLICACIÓN:

FORD: Ranger 1996>2012, F53 6.8 V10 1999>2004, F-150 4.9/5.0/5.8 V8 1987>2003, F-150 Heritage 4.2 V6/4.6/5.4 V8 2004, F-250 Super Duty 5.4 V8/6.8 V10/7.3 V8 Turbocharged 1998>11, F-350 Super Duty 5.4 V8/6.8 V10/7.3 V8 Turbocharged 1999>2004, F-450 Super Duty 6.8 V10/7.3 V8 Diesel Turbocharged 1999>2004, F-550 Super Duty 6.8 V10/7.3 V8 Diesel Turbocharged 1999>2004, Aerostar 3.0/4.0 V6 1990>1997, E-150 4.9/5.0 V8 1990>2008, E-250/E-350 4.9/5.0/5.8/7.5 V8/7.3 V8 Diesel 1990>2008, E-450 5.4 V8/6.8 V10/7.3 V8 Diesel Turbocharged 2000>2007, E-550 6.8 V10/7.3 V8 Diesel Turbocharged 2002, Econoline Super Duty 5.8 V8 1996>1998, Excursion 5.4 V8/6.8 V10/7.3 V8 Diesel Turbocharged 2000>2005, Expedition 4.6/5.4 V8 1997>2002, Explorer 4.0 V6 1991>2001, Explorer Sport Trac 4.0 V6 2001>2005, F-Super Duty 7.5 V8 1990>1997, Blackwood 5.4 V8 2002, Navigator 5.4 V8 1998>2002, Mountaineer 5.0 V8 1997>2001



GS1443

REPLACES / REEMPLAZA:

GM: 12215001, 15547452, 5S8078, 8155474520, 89054099, 92236443

APPLICATION / APLICACIÓN:

GM: S-10, Blazer 2.2, 2.4 Gasoline, S-10 Diesel Motor MWM, Silverado, C1500 92>, C2500 92>, C3500 92>93, K1500 88>00, K2500 88>, K3500 88>, Trail Blazer



GS1449

REPLACES / REEMPLAZA:

VW: 191919149E

APPLICATION / APLICACIÓN:

AUDI: A2 Hatch 2000>2005, A3 Mk1 Hatch 1996>2003, A4 Mk1 Saloon/Avant/Estate 1994>2001, A4 Mk2 Saloon/Avant/Estate 01>04, A4 Convertible 2002>2009, A4 Mk3 Saloon/Avant/Estate 2004>2008, A6 Mk2 Saloon/Avant/Estate 1997>2005, TT Coupe Mk1 /TT Roadster Cabrio Mk1 1998>2006;

SEAT: Alhambra MPV 1996>2010, Arosa Hatch 1997>2004, Cordoba Mk1 Hatch/Estate 1999>2002, Cordoba Mk2 Saloon 2002>2009, Ibiza Mk3 Hatch 1999>2002, Ibiza Mk4 Hatch 2002>2009, Ibiza Mk5 Hatch/Sportcoupe 2008>, Ibiza V ST 2010>, Leon Mk1 Hatch 1999>2006, Toledo Mk2 Saloon 1998>2006, Toledo IV 2012>;

SKODA: Fabia Mk1 Hatch/Saloon/Estate 1999>2008, Fabia Mk1 Van 2001>2007, Fabia Mk2 Hatch/Estate 2006>2014, Octavia Mk1 Hatch/Estate 1996>2010, Rapid/ Rapid Spaceback 2012>-, Roomster MPV 2006>2015, Praktik Van 2007>2015, Superb Mk1 Saloon 2001>2008;

VW: Bora Saloon/Estate 1998>2005, Caddy Mk2 Estate/Van 1995>2004, Golf Mk4 Hatch/Estate 1997>2006, Lupo Hatch 1998>2005, New Beetle 1998>2010, New Beetle Convertible 2002>2010, Passat Mk5 Saloon 1996>2005, Polo Mk3F Hatch 1999>2001, Polo Mk4/4F Hatch 2001>2012, Polo Mk4 Saloon 2002>, Sharan 1995>2010



GS1489

REPLACES / REEMPLAZA:

Standard: SC489

APPLICATION / APLICACIÓN:

NISSAN: Altima, Juke, NV200, Rogue, Sentra, Versa



GS1531

REPLACES / REEMPLAZA:

Ford: YS6T-9E731-AC, YS6T-9E731-AD

APPLICATION / APLICACIÓN:

FORD: Courier 1999>2001



GS1549

REPLACES / REEMPLAZA:

VW: 191919149D

APPLICATION / APLICACIÓN:

VW: Kombi Carburada (Todas), Cordoba 1994>1997, Mini Van 1994>1997, Polo Classic 1994>1997, Passat Variant 2.0 1994>1997, Beetle 1.9 Diesel/2.0 1998, Cabrio 2.0 1995>1996, Corrado 1.8 1990>1994, Passat 2.0 1991>1997



GS1551

REPLACES / REEMPLAZA:

Mazda: FN1121551, FN1121551PT, FN1221551A

APPLICATION / APLICACIÓN:

MAZDA: 323 hatch/saloon, 6 hatch/saloon/estate, CX-7



GS1603

REPLACES / REEMPLAZA:

OPEL / GM: 9114603, 1236304

APPLICATION / APLICACIÓN:

GM: Astra 99>11, Celta 01>16, Corsa Classic 94>16, New Corsa 02>12, Corsa 97>03, Meriva 02>12, Montana 04>10, Prisma 08>12, Tigra 98>00, Vectra 06>12, Zafira 01>12



GS1712

REPLACES / REEMPLAZA:

Honda: 28820PX400, 28820PX4003, 28820PX4010, 28820PX4024, 28820PX4801

APPLICATION / APLICACIÓN:

HONDA: Accord, Prelude

GS1731



REPLACES / REEMPLAZA:
Ford: DY943, YS4Z9E731AA, YS4Z9E731AB
APPLICATION / APLICACIÓN:
Ford: Focus 00>, New Fiesta 10> (Manual gear)

GS1741



REPLACES / REEMPLAZA:
Kia / Hyundai: 45955-22741
Standard: SC487
APPLICATION / APLICACIÓN:
KIA: Rio 2006>2011
HYUNDAI: Accent 2005>2011

GS1827



REPLACES / REEMPLAZA:
VW: 325957827, 377957827
APPLICATION / APLICACIÓN:
VW: Gol 1.0, 1.6, Parati 1.8, 2.0, Santana 1.8, Beetle;
Ford: Royale, Versailles 1.8, 2.0

GS1919



REPLACES / REEMPLAZA:
Renault: 7700418919
APPLICATION / APLICACIÓN:
Renault: Mégane 2.0, Clio, Twingo, Kangoo, Laguna

GS11003



REPLACES / REEMPLAZA:
JOHN DEERE: RE519144, RE537634, RE508195, RE505989, RE71121, RE43511, RE63919
APPLICATION / APLICACIÓN:
JOHN DEERE - HARVESTING: 1165, 1175 1450, 1550, 7760, 9670, 9770, 9870, 9935, 9965, 9970, 9976, 9996, c100, c230, cp690, s560, s660, s670, s680, s685, s690, t550, t560, t660, t670, w100, w210, w550, w650, w660, w80, y110, y115, y210, y215
JOHN DEERE - FARM SPRAYER: 4700, 4830
JOHN DEERE - TRACTORS: 1104, 1204 1354, 2104, 2704, 2904, 3204, 4560, 4760, 4960, 5045, 5050, 5060, 5065, 5075, 5083, 5093, 5100, 5101, 5200, 5220, 5300, 5303, 5320, 5400, 5403, 5420, 5500, 5520, 5603, 6095, 6100, 6110, 6115, 6125, 6135, 6150, 6165, 6170, 6185, 6190, 6205, 6210, 6415, 6534, 6615, 7200, 7210, 7215, 7230, 7400, 7410, 7510, 7530, 7600, 7610, 7700, 7710, 7715, 7800, 7810, 7815, 7830, 7930, 8225, 8235, 8245, 8260, 8270, 8285, 8295, 8310, 8320, 8335, 8345, 8370, 8570, 8770, 8870, 9100, 9120, 9200, 9220, 9300, 9320, 9400, 9410, 9420, 9460, 9470, 954



EMS COMPONENTS | SISTEMA DE CONTROL DE MOTOR

ABS SENSOR | SENSOR ABS

GS2000 // NEW //
FRONT WHEEL SENSOR (BOTH SIDES)

REPLACES / REEMPLAZA:

Audi: 8D0927803, 0986594014; **Bosch:** 0 986 594 014; **Meat & Doria:** 90008; **Mobiletron:** AB-EU040

APPLICATION / APLICACIÓN:

AUDI: A4 1.6 1988>2001, A4 1.8 1994>2001, A4 1.8 quattro 1994>2001, A4 1.8 T 1994>2001, A4 1.8 T quattro 1994>2001, A4 1.9 TDI 1994>2001, A4 1.9 TDI quattro 1994>2001, A4 2.4 1994>2001, A4 2.4 quattro 1994>2001, A4 2.5 TDI 1994>2001, A4 2.5 TDI quattro 1994>2001, A4 2.6 1994>2001, A4 2.6 quattro 1994>2001, A4 2.8 1994>2001, A4 2.8 quattro 1994>2001, A4 S4 quattro 1994>2001, A4 Avant 1.6 1994>2001, A4 Avant 1.8 1994>2001, A4 Avant 1.8 quattro 1994>2001, A4 Avant 1.8 T 1994>2001, A4 Avant 1.8 T quattro 1994>2001, A4 Avant 1.9 DUO 1994>2001, A4 Avant 1.9 TDI 1994>2001, A4 Avant 1.9 TDI quattro 1994>2001, A4 Avant 2.4 1994>2001, A4 Avant 2.4 quattro 1994>2001, A4 Avant 2.5 TDI 1994>2001, A4 Avant 2.5 TDI quattro 1994>2001, A4 Avant 2.6 1994>2001, A4 Avant 2.6 quattro 1994>2001, A4 Avant 2.8 1994>2001, A4 Avant 2.8 quattro 1994>2001, A4 Avant S4 quattro 1994>2001, A6 2.4 quattro 1997>2005, A6 Avant 2.4 quattro 1997>2005, A4 1.6 1994>2001, A4 Avant RS4 quattro 1994>2001;

VW: PASSAT 1.6 1996>2000, PASSAT 1.8 1996>2000, PASSAT 1.8 Syncro/4motion 1996>2000, PASSAT 1.8 T 1996>2000, PASSAT 1.8 T Syncro 1996>2000, PASSAT 1.9 TDI 1996>2000, PASSAT 1.9 TDI Syncro/4motion 1996>2000, PASSAT 2.0 1996>2000, PASSAT 2.3 VR5 1996>2000, PASSAT 2.3 VR5 Syncro/4motion 1996>2000, PASSAT 2.5 TDI 1996>2000, PASSAT 2.5 TDI Syncro/4motion 1996>2000, PASSAT 2.8 Syncro 1996>2000, PASSAT 2.8 V6 1996>2000, PASSAT 2.8 V6 Syncro/4motion 1996>2000, PASSAT Variant 1.6 1997>2000, PASSAT Variant 1.8 1997>2000, PASSAT Variant 1.8 4motion 1997>2000, PASSAT Variant 1.8 Syncro/4motion 1997>2000, PASSAT Variant 1.8 T 1997>2000, PASSAT Variant 1.9 TDI 1997>2000, PASSAT Variant 1.9 TDI Syncro/4motion 1997>2000, PASSAT Variant 2.3 VR5 1997>2000, PASSAT Variant 2.3 VR5 Syncro/4motion 1997>2000, PASSAT Variant 2.5 TDI 1997>2000, PASSAT Variant 2.5 TDI Syncro/4motion 1997>2000, PASSAT Variant 2.8 V6 1997>2000, PASSAT Variant 2.8 V6 Syncro/4motion 1997>2000, PASSAT 1.9 TDI 4motion 1996>2000, PASSAT 2.0 4motion 1996>2000, PASSAT 2.8 V6 4motion 1996>2000, PASSAT Variant 1.9 TDI 4motion 1997>2000, PASSAT Variant 2.0 1997>2000, PASSAT Variant 2.0 4motion 1997>2000, PASSAT Variant 2.8 V6 4motion 1997>2000

GS2001
FRONT WHEEL SENSOR (RIGHT SIDE)

REPLACES / REEMPLAZA:

Toyota: 8954260040

Lexus: 8954260040

APPLICATION / APLICACIÓN:

Toyota: Land Cruiser

Lexus: LX470

PS: set of GS2010

GS2002 // NEW //
FRONT WHEEL SENSOR (BOTH SIDES)

REPLACES / REEMPLAZA:

Fiat: 51918676, 52050137, 52137652

APPLICATION / APLICACIÓN:

FIAT: Argo HGT 1.8 2017>

PS: set of GS2003

GS2003 // NEW //
REAR WHEEL SENSOR (BOTH SIDES)

REPLACES / REEMPLAZA:

Fiat: 52064613

APPLICATION / APLICACIÓN:

FIAT: Argo HGT 1.8 2017>

PS: set of GS2002

GS2004 // NEW //
REAR WHEEL SENSOR (BOTH SIDES)

REPLACES / REEMPLAZA:

Hyundai: 52750-1GXXX, 52751-1G101FFF

APPLICATION / APLICACIÓN:

HYUNDAI: HB20 1.0/1.6 2013>

PS: set of GS2005 and GS2006

GS2005 // NEW //
FRONT WHEEL SENSOR (RIGHT SIDE)

REPLACES / REEMPLAZA:

Hyundai: 95671-1S300

APPLICATION / APLICACIÓN:

HYUNDAI: HB20 1.6 2012>

PS: set of GS2004 and GS2006

GS2006 // NEW //
FRONT WHEEL SENSOR (LEFT SIDE)

REPLACES / REEMPLAZA:

Hyundai: 95670-1S300

APPLICATION / APLICACIÓN:

HYUNDAI: HB20 1.6 2012>

PS: set of GS2004 and GS2005



GS2007 // NEW //

FRONT WHEEL SENSOR (LEFT SIDE)

REPLACES / REEMPLAZA:

VW: 1H0927807, 1J0927803, 0986594001; **Bosch:** 0 986 594 001; **Delphi:** SS10307; **Meat & Doria:** 90002; **Mobiletron:** AB-EU006

APPLICATION / APLICACIÓN:

AUDI: A3 1.6 1996>2003, A3 1.8 1996>2003, A3 1.8 T 1996>2003, A3 1.8 T quattro 1996>2003, A3 1.9 TDI 1996>2003, A3 1.9 TDI quattro 1996>2003, A3 S3 quattro 1996>2003, TT 1.8 T 1998>2006, TT 1.8 T quattro 1998>2006, TT 3.2 VR6 quattro 1998>2006, TT Roadster 1.8 T 1999>2006, TT Roadster 1.8 T quattro 1999>2006, TT Roadster 3.2 VR6 quattro 1999>2006, SEAT: AROSA 1.0 1997>2004, AROSA 1.4 1997>2004, AROSA 1.4 16V 1997>2004, AROSA 1.4 TDI 1997>2004, AROSA 1.7 SDI 1997>2004, CORDOBA 1.0 1993>2002, CORDOBA 1.0 i 1993>2002, CORDOBA 1.4 1993>2002, CORDOBA 1.4 16V 1993>2002, CORDOBA 1.4 i 1993>2002, CORDOBA 1.4 i 16V 1993>2002, CORDOBA 1.6 i 1993>2002, CORDOBA 1.8 i 1993>2002, CORDOBA 1.8 i 16V 1993>2002, CORDOBA 1.8 T 20V Cupra 1993>2002, CORDOBA 1.9 D 1993>2002, CORDOBA 1.9 SDI 1993>2002, CORDOBA 1.9 TD 1993>2002, CORDOBA 1.9 TD 1993>2002, CORDOBA 2.0 i 1993>2002, CORDOBA 2.0 i 16V 1993>2002, CORDOBA Vario 1.4 1996>2002, CORDOBA Vario 1.4 16V 1996>2002, CORDOBA Vario 1.4 i 1996>2002, CORDOBA Vario 1.6 i 1996>2002, CORDOBA Vario 1.8 i 1996>2002, CORDOBA Vario 1.9 SDI 1996>2002, CORDOBA Vario 1.9 TDI 1996>2002, CORDOBA VARIO Box Body/Estate 1.9 TDI 2000>2002, IBIZA II 1.0 16V 1993>2002, IBIZA II 1.0 i 1993>2002, IBIZA II 1.4 1993>2002, IBIZA II 1.4 16V 1993>2002, IBIZA II 1.4 i 1993>2002, IBIZA II 1.4 i 16V 1993>2002, IBIZA II 1.6 i 1993>2002, IBIZA II 1.8 i 1993>2002, IBIZA II 1.8 i 16V 1993>2002, IBIZA II 1.8 T 20V Cupra 1993>2002, IBIZA II 1.9 D 1993>2002, IBIZA II 1.9 SDI 1993>2002, IBIZA II 1.9 TD 1993>2002, IBIZA II 1.9 TDI 1993>2002, IBIZA II 2.0 i 1993>2002, IBIZA II 2.0 i 16V 1993>2002, INCA 1.4 16V 1995>2003, INCA 1.4 i 1995>2003, INCA 1.6 i 1995>2003, INCA 1.7 D 1995>2003, INCA 1.9 D 1995>2003, INCA 1.9 SDI 1995>2003, LEON 1.4 16V 1999>2006, LEON 1.6 1999>2006, LEON 1.6 16V 1999>2006, LEON 1.8 20V T 1999>2006, LEON 1.8 20V T 4 1999>2006, LEON 1.8 T Cupra R 1999>2006, LEON 1.9 SDI 1999>2006, LEON 1.9 TDI 1999>2006, LEON 1.9 TDI Syncro 1999>2006, LEON 2.8 1999>2006, LEON 2.8 Cupra 4 1999>2006, TOLEDO I 1.6 i 1991>1999, TOLEDO I 1.8 16V 1991>1999, TOLEDO I 1.8 i 1991>1999, TOLEDO I 1.9 D 1991>1999, TOLEDO I 1.9 TD 1991>1999, TOLEDO I 1.9 TDI 1991>1999, TOLEDO I 1.9 TDI 1991>1999, TOLEDO I 2.0 i 1991>1999, TOLEDO I 2.0 i 16V 1991>1999, TOLEDO I 2.0 i 16V 1991>1999, TOLEDO II 1.4 16V 1998>2006, TOLEDO II 1.6 16V 1998>2006, TOLEDO II 1.6 16V 1998>2006, TOLEDO II 1.8 20V 1998>2006, TOLEDO II 1.8 20V 1998>2006, TOLEDO II 1.9 TDI 1998>2006, TOLEDO II 1.9 TDI 1998>2006, TOLEDO II 2.3 V5 1998>2006, TOLEDO II 2.3 V5 20V 1998>2006, IBIZA II 1.0 1993>2002, IBIZA II 1.3 i 1993>2002, INCA 1.9 TDI 1995>2003, TOLEDO II 1.9 TDI 4Drive 1998>2006;

VW: BORA 2.0 Flex 2007>2010, BORA 1.4 16V 1998>2013, BORA 1.6 1998>2013, BORA 1.6 16V 1998>2013, BORA 1.6 FSI 1998>2013, BORA 1.8 1998>2013, BORA 1.8 4motion 1998>2013, BORA 1.8 T 1998>2013, BORA 1.8 T 4motion 1998>2013, BORA 1.9 SDI 1998>2013, BORA 1.9 TDI 1998>2013, BORA 1.9 TDI 4motion 1998>2013, BORA 2.0 1998>2013, BORA 2.0 4motion 1998>2013, BORA 2.3 V5 1998>2013, BORA 2.3 V5 4motion 1998>2013, BORA 2.8 V6 4motion 1998>2013, BORA 2.8 VR6 1998>2013, BORA Variant 1.4 16V 1999>2005, BORA Variant 1.6 1999>2005, BORA Variant 1.6 16V 1999>2005, BORA Variant 1.6 FSI 1999>2005, BORA Variant 1.8 1.4 4motion 1999>2005, BORA Variant 1.8 T 1999>2005, BORA Variant 1.9 TDI 1999>2005, BORA Variant 1.9 TDI 4motion 1999>2005, BORA Variant 2.0 4motion 1999>2005, BORA Variant 2.3 V5 1999>2005, BORA Variant 2.3 V5 4motion 1999>2005, BORA Variant 2.8 V6 4motion 1999>2005, CADDY Box 1.9 D 2005>2009, CADDY II Box 1.4 1995>2004, CADDY II Box 1.7 SDI 1995>2004, CADDY II Box 1.9 D 1995>2004, CADDY II Box 1.9 SDI 1995>2004, CADDY II Box 1.9 TDI 1995>2004, CADDY II Box 60 1.4 1995>2004, CADDY II Box 75 1.6 1995>2004, CADDY II Estate 1.4 1995>2004, CADDY II Estate 1.4 16V 1995>2004, CADDY II Estate 1.4 16V 1995>2004, CADDY II Estate 1.7 SDI 1995>2004, CADDY II Estate 1.9 D 1995>2004, CADDY II Estate 1.9 SDI 1995>2004, CADDY II Estate 1.9 TDI 1995>2004, CORRADO 1.8 G60 1988>1995, GOLF III 1.4 1991>1997, GOLF III 1.6 1991>1997, GOLF III 1.8 1991>1997, GOLF III 1.8 Syncro (1HX1) 1991>1997, GOLF III 1.9 D 1991>1997, GOLF III 1.9 SDI 1991>1997, GOLF III 1.9 TD, GTD 1991>1997, GOLF III 1.9 TDI 1991>1997, GOLF III 1.9 TDI Syncro (1HX1) 1991>1997, GOLF III 2.0 1991>1997, GOLF III 2.0 GL 1991>1997, GOLF III 2.0 GTI 16V 1991>1997, GOLF III 2.0 Syncro (1HX1) 1991>1997, GOLF III 2.8 VR6 1991>1997, GOLF III 2.9 VR6 Syncro (1HX1) 1991>1997, GOLF III Cabriolet 1.6 1993>1998, GOLF III Cabriolet 1.8 1993>1998, GOLF III Cabriolet 1.9 TDI 1993>1998, GOLF III Cabriolet 2.0 1993>1998, GOLF III Van 1.4 1991>1997, GOLF III Van 1.6 1991>1997, GOLF III Van 1.8 1991>1997, GOLF III Van 1.9 D 1991>1997, GOLF III Van 1.9 SDI 1991>1997, GOLF III Van 1.9 TDI 1991>1997, GOLF III Van 2.0 1991>1997, GOLF III Van 2.0 GTI 1991>1997, GOLF III Variant 1.4 1993>1999, GOLF III Variant 1.6 1993>1999, GOLF III Variant 1.8 1993>1999, GOLF III Variant 1.8 Syncro 1993>1999, GOLF III Variant 1.9 D 1993>1999, GOLF III Variant 1.9 SDI 1993>1999, GOLF III Variant 1.9 TD 1993>1999, GOLF III Variant 1.9 TDI 1993>1999, GOLF III Variant 1.9 TDI Syncro 1993>1999, GOLF III Variant 2.0 1993>1999, GOLF III Variant 2.0 Syncro 1993>1999, GOLF III Variant 2.9 VR6 Syncro 1993>1999, GOLF IV 1.4 16V 1997>2007, GOLF IV 1.6 1997>2007, GOLF IV 1.6 16V 1997>2007, GOLF IV 1.6 FSI 1997>2007, GOLF IV 1.8 1997>2007, GOLF IV 1.8 4motion 1997>2007, GOLF IV 1.8 T 1997>2007, GOLF IV 1.8 T GTI 1997>2007, GOLF IV 1.9 SDI 1997>2007, GOLF IV 1.9 TD 1997>2007, GOLF IV 1.9 TDI 1997>2007, GOLF IV 1.9 TDI 4motion 1997>2007, GOLF IV 2.0 1997>2007, GOLF IV 2.0 4motion 1997>2007, GOLF IV 2.0 BiFuel 1997>2007, GOLF IV 2.3 V5 1997>2007, GOLF IV 2.3 V5 4motion 1997>2007, GOLF IV 2.8 VR6 1997>2007, GOLF IV 2.8 VR6 4motion 1997>2007, GOLF IV 3.2 R32 4motion 1997>2007, GOLF IV Cabriolet 1.6 1998>2002, GOLF IV Cabriolet 1.8 1998>2002, GOLF IV Cabriolet 1.9 TDI 1998>2002, GOLF IV Cabriolet 2.0 1998>2002, GOLF IV Van 1.9 SDI 1997>2004, GOLF IV Van 1.9 TDI 1997>2004, GOLF IV Van 1.9 TDI 4motion 1997>2004, GOLF IV Variant 1.4 16V 1999>2006, GOLF IV Variant 1.6 1999>2006, GOLF IV Variant 1.6 16V 1999>2006, GOLF IV Variant 1.6 FSI 1999>2006, GOLF IV Variant 1.8 4motion 1999>2006, GOLF IV Variant 1.8 T 1999>2006, GOLF IV Variant 1.9 SDI 1999>2006, GOLF IV Variant 1.9 TDI 1999>2006, GOLF IV Variant 1.9 TDI 4motion 1999>2006, GOLF IV Variant 2.0 1999>2006, GOLF IV Variant 2.0 Bi-Fuel 1999>2006, GOLF IV Variant 2.3 V5 1999>2006, GOLF IV Variant 2.3 V5 4motion 1999>2006, GOLF IV Variant 2.8 V6 4motion 1999>2006, GOLF V 1.6 MultiFuel 2003>2009, GOLF V 2.0 2003>2009, GOLF Van III Variant 1.4 1993>1999, GOLF Van III Variant 1.8 1993>1999, GOLF Van III Variant 1.9 1993>1999, GOLF Van III Variant 1.9 SDI 1993>1999, GOLF Van III Variant 1.9 TDI 1993>1999, GOLF VAN IV Variant 1.4 1999>2006, GOLF VAN IV Variant 1.6 1999>2006, GOLF VAN IV Variant 1.9 SDI 1999>2006, GOLF VAN IV Variant 1.9 TDI 1999>2006, LUPO 1.0 1998>2005, LUPO 1.4 1998>2005, LUPO 1.4 16V 1998>2005, LUPO 1.4 FSI 1998>2005, LUPO 1.4 TDI 1998>2005, LUPO 1.6 GTI 1998>2005, LUPO 1.7 SDI 1998>2005, NEW BEETLE 1.4 1998>2010, NEW BEETLE 1.6 1998>2010, NEW BEETLE 1.8 T 1998>2010, NEW BEETLE 1.9 TDI 1998>2010, NEW BEETLE 2.0 1998>2010, NEW BEETLE 2.3 V5 1998>2010, NEW BEETLE 2.5 1998>2010, NEW BEETLE 2.5 4motion (1C9) 1998>2010, NEW BEETLE Convertible 1.4 2002>2010, NEW BEETLE Convertible 1.6 2002>2010, NEW BEETLE Convertible 1.8 T 2002>2010, NEW BEETLE Convertible 1.9 TDI 2002>2010, NEW BEETLE Convertible 2.0 2002>2010, NEW BEETLE Convertible 2.5 2002>2010, PASSAT 1.8 1991>1996, PASSAT 1.9 TD 1991>1996, PASSAT 2.0 1991>1996, PASSAT 2.0 1998>1996, PASSAT 2.8 VR6 1988>1996, PASSAT 2.8 VR6 1988>1996, PASSAT Variant 1.6 1988>1997, PASSAT Variant 1.8 1988>1997, PASSAT Variant 1.9 TD 1988>1997, PASSAT Variant 1.9 TDI 1988>1997, PASSAT Variant 2.0 1988>1997, PASSAT Variant 2.0 16V 1988>1997, PASSAT Variant 2.8 VR6 1988>1997, PASSAT Variant 2.0 16V 1988>1997, PASSAT Variant 2.8 VR6 1988>1997, POLO 1.7 SDI 1994>1999, POLO 100 1.4 16V 1994>1999, POLO 120 1.6 16V GTI 1994>1999, POLO 45 1.0 1994>1999, POLO 50 1.0 1994>1999, POLO 55 1.3 1994>1999, POLO 55 1.4 1994>1999, POLO 60 1.4 1994>1999, POLO 60 1.7 SDI 1994>1999, POLO 64 1.9 D 1994>1999, POLO 64 1.9 SDI 1994>1999, POLO 75 1.6 1994>1999, POLO 1.0 1999>2001, POLO 1.4 1999>2001, POLO 1.4 16V 1999>2001, POLO 1.6 16V GTI 1999>2001, POLO 1.7 SDI 1999>2001, POLO 1.9 D 1999>2001, POLO 1.9 SDI 1999>2001, POLO Classic 1.6 1995>2003, POLO Classic 1.8 1995>2003, POLO Classic 1.9 SDI 1995>2003, POLO Classic 1.9 TDI 1995>2003, POLO Classic 100 1.6 1995>2003, POLO Classic 110 1.9 TDI 1995>2003, POLO Classic 54 1.4 1995>2003, POLO Classic 57 1.7 SDI 1995>2003, POLO Classic 60 1.4 1995>2003, POLO Classic 64 1.9 D 1995>2003, POLO Classic 64 1.9 SDI 1995>2003, POLO Classic 68 1.9 SDI 1995>2003, POLO Classic 75 1.4 16V 1995>2003, POLO Classic 75 1.6 1995>2003, POLO Classic 90 1.8 1995>2003, POLO Classic 90 1.9 TDI 1995>2003, POLO Van Box Body / Hatchback 1.0 1994>1999, POLO Van Box Body/Estate 1.4 1996>2001, POLO Van Box Body/Estate 1.6 1996>2001, POLO Van Box Body/Estate 1.9 SDI 1996>2001, POLO Variant 1.4 1997>2001, POLO Variant 1.4 16V 1997>2001, POLO Variant 1.6 1997>2001, POLO Variant 1.7 SDI 1997>2001, POLO Variant 1.9 SDI 1997>2001, POLO Variant 1.9 TDI 1997>2001, VENTO 1.4 1991>1998, VENTO 1.6 1991>1998, VENTO 1.8 1991>1998, VENTO 1.9 D 1991>1998, VENTO 1.9 SDI 1991>1998, VENTO 1.9 TD 1991>1998, VENTO 1.9 TDI 1991>1998, VENTO 2.0 1991>1998, VENTO 2.0 GL 1991>1998, VENTO 2.8 VR6 1991>1998, BORA 2.0 2007>2010, BORA Variant 2.0 1999>2005, CADDY II Pickup 1.6 1996>2000, CADDY II Pickup 1.9 D 1996>2000, CORRADO 1.8 16V 1988>1995, CORRADO 2.0 i 1988>1995, CORRADO 2.0 i 16V 1988>1995, CORRADO 2.9 VR6 1988>1995, GOLF III Cityströmer 1991>1997, PASSAT 1.8 G60 Syncro 1988>1996, PASSAT 2.0 Syncro 1988>1996, PASSAT 1.8 Syncro/4motion 1996>2000, PASSAT 1.8 T Syncro 1996>2000, PASSAT 1.9 TDI Syncro/4motion 1996>2000, PASSAT 2.8 V6 Syncro/4motion 1996>2000, PASSAT 2.8 4motion 2000>2005, PASSAT Variant 1.8 G60 Syncro 1988>1997, PASSAT Variant 2.0 Syncro 1988>1997, PASSAT Variant 2.9 VR6 Syncro 1988>1997, POLO Van Box Body/Estate 1.7 SDI 1996>2001, POLO Variant 1.8 1997>2001, SKODA: OCTAVIA I 1.4 1996>2010, OCTAVIA I 1.4 16V 1996>2010, OCTAVIA I 1.6 1996>2010, OCTAVIA I 1.8 1996>2010, OCTAVIA I 1.8 T 1996>2010, OCTAVIA I 1.8 T 4x4 1996>2010, OCTAVIA I 1.9 SDI 1996>2010, OCTAVIA I 1.9 TDI 1996>2010, OCTAVIA I 2.0 1996>2010, OCTAVIA I RS 1.8 T 1996>2010, OCTAVIA I Box Body/Estate 1.9 D 2000>2010, OCTAVIA I Box Body/Estate 1.9 TDI 2000>2010, OCTAVIA I Combi 1.4 16V 1998>2010, OCTAVIA I Combi 1.6 1998>2010, OCTAVIA I Combi 1.8 20V 1998>2010, OCTAVIA I Combi 1.8 T 1998>2010, OCTAVIA I Combi 1.8 T 4x4 1998>2010, OCTAVIA I Combi 1.9 SDI 1998>2010, OCTAVIA I Combi 1.9 TDI 1998>2010, OCTAVIA I Combi 1.9 TDI 4x4 1998>2010, OCTAVIA I Combi 2.0 1998>2010, OCTAVIA I Combi 2.0 4x4 1998>2010, OCTAVIA I Combi RS 1.8 T 1998>2010

GS2008 // NEW //
FRONT WHEEL SENSOR (RIGHT SIDE)
REPLACES / REEMPLAZA:
VW: 1H0927808, 1J0927804, 0986594000; **Bosch:** 0 986 594 000; **Delphi:** SS10308; **Cargo:** 181854; **Meat & Doria:** 90001; **Mobiletron:** AB-EU003

APPLICATION / APLICACIÓN:

AUDI: A3 1.6 1996>2003, A3 1.8 1996>2003, A3 1.8 T 1996>2003, A3 1.8 T quattro 1996>2003, A3 1.9 TDI 1996>2003, A3 S3 quattro 1996>2003, TT 1.8 T 1998>2006, TT 1.8 T quattro 1998>2006, TT 3.2 VR6 quattro 1998>2006, TT Roadster 1.8 T 1999>2006, TT Roadster 1.8 T quattro 1999>2006, TT Roadster 3.2 VR6 quattro 1999>2006, A3 S3 quattro 2003>2012, SEAT: AROSA 1.0 1997>2004, AROSA 1.4 1997>2004, AROSA 1.4 16V 1997>2004, AROSA 1.4 TDI 1997>2004, AROSA 1.7 SDI 1997>2004, CORDOBA 1.0 1993>2002, CORDOBA 1.0 i 1993>2002, CORDOBA 1.4 1993>2002, CORDOBA 1.4 16V 1993>2002, CORDOBA 1.4 i 1993>2002, CORDOBA 1.4 i 16V 1993>2002, CORDOBA 1.6 i 1993>2002, CORDOBA 1.8 i 1993>2002, CORDOBA 1.8 i 16V 1993>2002, CORDOBA 1.8 T 20V Cupra 1993>2002, CORDOBA 1.9 D 1993>2002, CORDOBA 1.9 SDI 1993>2002, CORDOBA 1.9 TD 1993>2002, CORDOBA 1.9 TDI 1993>2002, CORDOBA 2.0 i 1993>2002, CORDOBA 2.0 i 16V 1993>2002, CORDOBA Vario 1.4 1996>2002, CORDOBA Vario 1.4 16V 1996>2002, CORDOBA Vario 1.4 i 1996>2002, CORDOBA Vario 1.6 i 1996>2002, CORDOBA Vario 1.8 i 1996>2002, CORDOBA Vario 1.9 SDI 1996>2002, CORDOBA Vario 1.9 TDI 1996>2002, CORDOBA Vario 1.9 TDI 1996>2002, CORDOBA Vario Box Body/Estate 1.9 TDI 2000>2002, IBIZA II 1.0 16V 1993>2002, IBIZA II 1.0 i 1993>2002, IBIZA II 1.4 1993>2002, IBIZA II 1.4 16V 1993>2002, IBIZA II 1.4 i 16V 1993>2002, IBIZA II 1.6 i 1993>2002, IBIZA II 1.8 i 1993>2002, IBIZA II 1.8 i 16V 1993>2002, IBIZA II 1.8 T 20V Cupra 1993>2002, IBIZA II 1.9 D 1993>2002, IBIZA II 1.9 SDI 1993>2002, IBIZA II 1.9 TDI 1993>2002, IBIZA II 1.9 TDI 1993>2002, IBIZA II 2.0 i 1993>2002, IBIZA II 2.0 i 16V 1993>2002, INCA 1.4 16V 1995>2003, INCA 1.6 i 1995>2003, INCA 1.7 D 1995>2003, INCA 1.9 D 1995>2003, INCA 1.9 SDI 1995>2003, LEON 1.4 16V 1999>2006, LEON 1.6 16V 1999>2006, LEON 1.8 20V 1999>2006, LEON 1.8 20V T 1999>2006, LEON 1.8 T Cupra R 1999>2006, LEON 1.9 SDI 1999>2006, LEON 1.9 TDI 1999>2006, LEON 1.9 TDI Syncro 1999>2006, LEON 2.8 1999>2006, LEON 2.8 Cupra 4 1999>2006, TOLEDO I 1.6 i 1991>1999, TOLEDO I 1.8 16V 1991>1999, TOLEDO I 1.8 i 1991>1999, TOLEDO I 1.9 D 1991>1999, TOLEDO I 1.9 TDI 1991>1999, TOLEDO I 1.9 TDI 1991>1999, TOLEDO I 2.0 i 1991>1999, TOLEDO I 2.0 i 16V 1991>1999, TOLEDO II 1.4 16V 1998>2006, TOLEDO II 1.6 1998>2006, TOLEDO II 1.6 16V 1998>2006, TOLEDO II 1.8 20V 1998>2006, TOLEDO II 1.8 20VT 1998>2006, TOLEDO II 1.9 TDI 1998>2006, TOLEDO II 2.3 V5 1998>2006, TOLEDO II 2.3 V5 20V 1998>2006, IBIZA II 1.0 1993>2002, IBIZA II 1.3 i 1993>2002, INCA 1.9 TDI 1995>2003, TOLEDO II 1.9 TDI 4Drive 1998>2006;

VW: BORA 2.0 Flex 2007>2010, BORA 1.4 16V 1998>2013, BORA 1.6 1998>2013, BORA 1.6 16V 1998>2013, BORA 1.6 FSI 1998>2013, BORA 1.8 1998>2013, BORA 1.8 4motion 1998>2013, BORA 1.8 T 1998>2013, BORA 1.8 T 4motion 1998>2013, BORA 1.9 SDI 1998>2013, BORA 1.9 TDI 1998>2013, BORA 1.9 TDI 4motion 1998>2013, BORA 2.0 1998>2013, BORA 2.0 4motion 1998>2013, BORA 2.3 V5 1998>2013, BORA 2.3 V5 4motion 1998>2013, BORA 2.8 V6 4motion 1998>2013, BORA 2.8 VR6 1998>2013, BORA Variant 1.4 16V 1999>2005, BORA Variant 1.6 1999>2005, BORA Variant 1.6 16V 1999>2005, BORA Variant 1.6 FSI 1999>2005, BORA Variant 1.8 4motion 1999>2005, BORA Variant 1.8 T 1999>2005, BORA Variant 1.8 T 4motion 1999>2005, BORA Variant 1.9 TDI 1999>2005, BORA Variant 1.9 TDI 4motion 1999>2005, BORA Variant 2.0 4motion 1999>2005, BORA Variant 2.3 V5 1999>2005, BORA Variant 2.3 V5 4motion 1999>2005, BORA Variant 2.8 V6 4motion 1999>2005, CADDY Box 1.9 D 2005>2009, CADDY II Box 1.4 1995>2004, CADDY II Box 1.7 SDI 1995>2004, CADDY II Box 1.9 D 1995>2004, CADDY II Box 1.9 SDI 1995>2004, CADDY II Box 1.9 TDI 1995>2004, CADDY II Box 1.9 TDI 1995>2004, CADDY II Box 1.9 TDI 1995>2004, CADDY II Estate 1.4 16V 1995>2004, CADDY II Estate 1.4 16V 1995>2004, CADDY II Estate 1.7 SDI 1995>2004, CADDY II Estate 1.9 D 1995>2004, CADDY II Estate 1.9 SDI 1995>2004, CADDY II Estate 1.9 TDI 1995>2004, CORRADO 1.8 G60 1988>1995, GOLF III 1.4 1991>1997, GOLF III 1.6 1991>1997, GOLF III 1.8 1991>1997, GOLF III 1.8 Syncro (1HX1) 1991>1997, GOLF III 1.9 D 1991>1997, GOLF III 1.9 SDI 1991>1997, GOLF III 1.9 TDI 1991>1997, GOLF III 1.9 TDI Syncro (1HX1) 1991>1997, GOLF III 1.9 TDI Syncro (1HX1) 1991>1997, GOLF III 2.0 1991>1997, GOLF III 2.0 GL 1991>1997, GOLF III 2.0 GTI 16V 1991>1997, GOLF III 2.0 Syncro (1HX1) 1991>1997, GOLF III 2.8 VR6 1991>1997, GOLF III 2.9 VR6 Syncro (1HX1) 1991>1997, GOLF III Cabriolet 1.6 1993>1998, GOLF III Cabriolet 1.8 1993>1998, GOLF III Cabriolet 1.9 TDI 1993>1998, GOLF III Cabriolet 2.0 1993>1998, GOLF III Van 1.4 1991>1997, GOLF III Van 1.6 1991>1997, GOLF III Van 1.8 1991>1997, GOLF III Van 1.9 D 1991>1997, GOLF III Van 1.9 SDI 1991>1997, GOLF III Van 1.9 TDI 1991>1997, GOLF III Van 2.0 1991>1997, GOLF III Van 2.0 GTI 1991>1997, GOLF III Variant 1.4 1993>1999, GOLF III Variant 1.6 1993>1999, GOLF III Variant 1.8 1993>1999, GOLF III Variant 1.8 Syncro 1993>1999, GOLF III Variant 1.9 D 1993>1999, GOLF III Variant 1.9 SDI 1993>1999, GOLF III Variant 1.9 TD 1993>1999, GOLF III Variant 1.9 TDI 1993>1999, GOLF III Variant 1.9 TDI Syncro 1993>1999, GOLF III Variant 2.0 1993>1999, GOLF III Variant 2.0 Syncro 1993>1999, GOLF III Variant 2.9 VR6 Syncro 1993>1999, GOLF IV 1.4 16V 1997>2007, GOLF IV 1.6 1997>2007, GOLF IV 1.6 16V 1997>2007, GOLF IV 1.6 FSI 1997>2007, GOLF IV 1.8 1997>2007, GOLF IV 1.8 4motion 1997>2007, GOLF IV 1.8 T 1997>2007, GOLF IV 1.8 T GTI 1997>2007, GOLF IV 1.9 SDI 1997>2007, GOLF IV 1.9 TD 1997>2007, GOLF IV 1.9 TDI 1997>2007, GOLF IV 1.9 TDI 4motion 1997>2007, GOLF IV 2.0 1997>2007, GOLF IV 2.0 4motion 1997>2007, GOLF IV 2.0 BiFuel 1997>2007, GOLF IV 2.3 V5 1997>2007, GOLF IV 2.3 V5 4motion 1997>2007, GOLF IV 2.8 VR6 1997>2007, GOLF IV 2.8 VR6 4motion 1997>2007, GOLF IV 3.2 R32 4motion 1997>2007, GOLF IV Cabriolet 1.6 1998>2002, GOLF IV Cabriolet 1.8 1998>2002, GOLF IV Cabriolet 1.9 TDI 1998>2002, GOLF IV Cabriolet 2.0 1998>2002, GOLF IV Van 1.9 SDI 1997>2004, GOLF IV Van 1.9 TDI 1997>2004, GOLF IV Van 1.9 TDI 4motion 1997>2004, GOLF IV Variant 1.4 16V 1999>2006, GOLF IV Variant 1.6 1999>2006, GOLF IV Variant 1.6 16V 1999>2006, GOLF IV Variant 1.6 FSI 1999>2006, GOLF IV Variant 1.8 4motion 1999>2006, GOLF IV Variant 1.8 T 1999>2006, GOLF IV Variant 2.0 1999>2006, GOLF IV Variant 2.0 4motion 1999>2006, GOLF IV Variant 2.0 Bi-Fuel 1999>2006, GOLF IV Variant 2.3 V5 1999>2006, GOLF IV Variant 2.3 V5 4motion 1999>2006, GOLF IV Variant 2.8 V6 4motion 1999>2006, GOLF V 1.6 MultiFuel 2003>2009, GOLF V 2.0 2003>2009, GOLF Van III Variant 1.4 1993>1999, GOLF Van III Variant 1.8 1993>1999, GOLF Van III Variant 1.9 1993>1999, GOLF Van III Variant 1.9 SDI 1993>1999, GOLF Van III Variant 1.9 TDI 1993>1999, GOLF VAN IV Variant 1.4 1999>2006, GOLF VAN IV Variant 1.6 1999>2006, GOLF VAN IV Variant 1.9 SDI 1999>2006, GOLF VAN IV Variant 1.9 TDI 1999>2006, LUPO 1.0 1998>2005, LUPO 1.4 1998>2005, LUPO 1.4 16V 1998>2005, LUPO 1.4 FSI 1998>2005, LUPO 1.4 TDI 1998>2005, LUPO 1.6 GTI 1998>2005, LUPO 1.7 SDI 1998>2005, NEW BEETLE 1.4 1998>2010, NEW BEETLE 1.6 1998>2010, NEW BEETLE 1.8 T 1998>2010, NEW BEETLE 1.9 TDI 1998>2010, NEW BEETLE 2.0 1998>2010, NEW BEETLE 2.3 V5 1998>2010, NEW BEETLE 2.5 1998>2010, NEW BEETLE RSI 3.2 4motion (1C9) 1998>2010, NEW BEETLE Convertible 1.4 2002>2010, NEW BEETLE Convertible 1.6 2002>2010, NEW BEETLE Convertible 1.8 T 2002>2010, NEW BEETLE Convertible 1.9 TDI 2002>2010, NEW BEETLE Convertible 2.0 2002>2010, NEW BEETLE Convertible 2.5 2002>2010, PASSAT 1.8 1991>1996, PASSAT 1.9 TD 1991>1996, PASSAT 2.0 1991>1996, PASSAT 1.6 1988>1996, PASSAT 1.8 1988>1996, PASSAT 1.9 TD 1988>1996, PASSAT 1.9 TDI 1988>1996, PASSAT 2.0 1988>1996, PASSAT 2.0 16V 1988>1996, PASSAT 2.8 VR6 1988>1996, PASSAT Variant 1.6 1988>1997, PASSAT Variant 1.8 1988>1997, PASSAT Variant 1.9 TD 1988>1997, PASSAT Variant 1.9 TDI 1988>1997, PASSAT Variant 2.0 1988>1997, PASSAT Variant 2.0 16V 1988>1997, PASSAT Variant 2.8 VR6 1988>1997, POLO 1.7 SDI 1994>1999, POLO 100 1.4 16V 1994>1999, POLO 120 1.6 16V GTI 1994>1999, POLO 45 1.0 1994>1999, POLO 50 1.0 1994>1999, POLO 55 1.3 1994>1999, POLO 55 1.4 1994>1999, POLO 60 1.4 1994>1999, POLO 60 1.7 SDI 1994>1999, POLO 64 1.9 D 1994>1999, POLO 64 1.9 SDI 1994>1999, POLO 75 1.6 1994>1999, POLO 1.0 1999>2001, POLO 1.4 16V 1999>2001, POLO 1.4 16V GTI 1999>2001, POLO 1.7 SDI 1999>2001, POLO 1.9 D 1999>2001, POLO 1.9 SDI 1999>2001, POLO Classic 1.6 1995>2003, POLO Classic 1.8 1995>2003, POLO Classic 1.9 SDI 1995>2003, POLO Classic 1.9 TDI 1995>2003, POLO Classic 100 1.6 1995>2003, POLO Classic 110 1.9 TDI 1995>2003, POLO Classic 54 1.4 1995>2003, POLO Classic 57 1.7 SDI 1995>2003, POLO Classic 60 1.4 1995>2003, POLO Classic 64 1.9 D 1995>2003, POLO Classic 64 1.9 SDI 1995>2003, POLO Classic 68 1.9 SDI 1995>2003, POLO Classic 75 1.4 16V 1995>2003, POLO Classic 75 1.6 1995>2003, POLO Classic 90 1.8 1995>2003, POLO Classic 90 1.9 TDI 1995>2003, POLO Van Box Body / Hatchback 1.0 1994>1999, POLO Van Box Body/Estate 1.4 1996>2001, POLO Van Box Body/Estate 1.6 1996>2001, POLO Van Box Body/Estate 1.9 SDI 1996>2001, POLO Variant 1.4 1997>2001, POLO Variant 1.4 16V 1997>2001, POLO Variant 1.6 1997>2001, POLO Variant 1.7 SDI 1997>2001, POLO Variant 1.9 SDI 1997>2001, POLO Variant 1.9 TDI 1997>2001, VENTO 1.4 1991>1998, VENTO 1.6 1991>1998, VENTO 1.8 1991>1998, VENTO 1.9 D 1991>1998, VENTO 1.9 SDI 1991>1998, VENTO 1.9 TD 1991>1998, VENTO 1.9 TDI 1991>1998, VENTO 2.0 1991>1998, VENTO 2.0 GL 1991>1998, VENTO 2.8 VR6 1991>1998, BORA 2.0 2007>2010, BORA Variant 2.0 1999>2005, CADDY II Pickup 1.6 1996>2000, CADDY II Pickup 1.9 D 1996>2000, CORRADO 1.8 16V 1988>1995, CORRADO 2.0 i 1988>1995, CORRADO 2.0 i 16V 1988>1995, CORRADO 2.9 VR6 1988>1995, GOLF III Citystrmer 1991>1997, PASSAT 1.8 G60 Syncro 1988>1996, PASSAT 2.0 Syncro 1988>1996, PASSAT 1.8 Syncro/4motion 1996>2000, PASSAT 1.8 T Syncro 1996>2000, PASSAT 1.9 TDI Syncro/4motion 1996>2000, PASSAT 2.8 V6 Syncro/4motion 1996>2000, PASSAT 2.8 4motion 2000>2005, PASSAT Variant 1.8 G60 Syncro 1988>1997, PASSAT Variant 2.0 Syncro 1988>1997, PASSAT Variant 2.9 VR6 Syncro 1988>1997, POLO Classic 2.0 1995>2003, POLO Van Box Body/Estate 1.7 SDI 1996>2001, POLO Variant 1.8 1997>2001, SKODA: OCTAVIA I 1.4 1996>2010, OCTAVIA I 1.4 16V 1996>2010, OCTAVIA I 1.6 1996>2010, OCTAVIA I 1.8 1996>2010, OCTAVIA I 1.8 T 1996>2010, OCTAVIA I 1.8 T 4x4 1996>2010, OCTAVIA I 1.9 SDI 1996>2010, OCTAVIA I 1.9 TDI 1996>2010, OCTAVIA I 2.0 1996>2010, OCTAVIA I RS 1.8 T 1996>2010, OCTAVIA I Box Body/Estate 1.9 D 2000>2010, OCTAVIA I Box Body/Estate 1.9 TDI 2000>2010, OCTAVIA I Combi 1.4 16V 1998>2010, OCTAVIA I Combi 1.6 1998>2010, OCTAVIA I Combi 1.8 20V 1998>2010, OCTAVIA I Combi 1.8 T 1998>2010, OCTAVIA I Combi 1.8 T 4x4 1998>2010, OCTAVIA I Combi 1.9 SDI 1998>2010, OCTAVIA I Combi 1.9 TDI 1998>2010, OCTAVIA I Combi 1.9 TDI 4x4 1998>2010, OCTAVIA I Combi 2.0 1998>2010, OCTAVIA I Combi 2.0 4x4 1998>2010, OCTAVIA I Combi RS 1.8 T 1998>2010

GS2009 // NEW //

REAR WHEEL SENSOR (BOTH SIDES)



REPLACES / REEMPLAZA:

VW: 1J0927807; **Bosch:** 0 986 594 0004; **Delphi:** SS20000; **Cargo:** 181870; **Meat & Doria:** 90003; **Mobiletron:** AB-EU002

APPLICATION / APLICACIÓN:

AUDI: A3 1.6 1996>2003, A3 1.8 1996>2003, A3 1.8 T 1996>2003, A3 1.8 T Quattro 1998>2003, A3 1.9 Tdi 1996>2001, Tt 1.8 T 1998>2006, Tt Roadster 1.8 T 1999>2006;

SEAT: Arosa 1.0 1997>2001, Arosa 1.4 1997>2004, Arosa 1.4 16V 2000>2004, Arosa 1.4 Tdi 2000>2004, Arosa 1.7 Sdi 1997>2004, Leon 1.4 16V 1999>2006, Leon 1.6 1999>2006, Leon 1.6 V 2000>2006, Leon 1.8 20V 1999>2006, Leon 1.8 20V T 1999>2006, Leon 1.8 20V T 4 1999>2006, Leon 1.8 T Cupra R 2002>2006, Leon 1.9 Sdi 1999>2006, Leon 1.9 Tdi 1999>2006, Toledo I 1.6 I 1991>1999, Toledo I 1.9 Tdi 1995>1999, Toledo Ii 1.4 16V 2000>2002, Toledo Ii 1.6 1998>2004, Toledo Ii 1.6 16V 2000>2006, Toledo Ii 1.8 20V 1998>2004, Toledo Ii 1.8 20Vt 2000>2004, Toledo Ii 1.9 Tdi 1998>2004, Toledo Ii 2.3 V5 1998>2000, Toledo Ii 2.3 V5 20V 2000>2003;

SKODA: Felicia I 1.6 Lx 1995>1998, Felicia I 1.9 D 1995>1998, Felicia I Pick-Up 1.9 D 1997>2002, Felicia I Sw 1.6 Glx 1995>1998, Felicia I Sw 1.9 D 1995>1998, Felicia Ii 1.3 1998>2001, Felicia Ii 1.6 1998>2001, Felicia Ii 1.9 D 1998>2001, Felicia Ii Sw 1.3 1998>2001, Felicia Ii Sw 1.6 1998>2001, Felicia Ii Sw 1.9 D 1998>2001, Octavia I 1.4 1999>2001, Octavia I 1.4 16V 2000>2010, Octavia I 1.6 1996>2004, Octavia I 1.8 1996>2000, Octavia I 1.8 T 1997>2010, Octavia I 1.8 T 4X4 2001>2006, Octavia I 1.9 Sdi 1997>2003, Octavia I 1.9 Tdi 1996>2004, Octavia I 2.0 1999>2007, Octavia I Rs 1.8 T 2001>2006, Octavia I Combi 1.4 16V 2000>2010, Octavia I Combi 1.6 1998>2004, Octavia I Combi 1.8 20V 1998>2000, Octavia I Combi 1.8 T 1998>2010, Octavia I Combi 1.8 T 4X4 2001>2006, Octavia I Combi 1.9 Sdi 1998>2003, Octavia I Combi 1.9 Tdi 1998>2004, Octavia I Combi 1.9 Tdi 4X4 1999>2006, Octavia I Combi 2.0 1999>2007, Octavia I Combi Rs 1.8 T 2002>2006

GS2010

FRONT WHEEL SENSOR (LEFT SIDE)



REPLACES / REEMPLAZA:

Toyota: 8954360010

Lexus: 8954360010

APPLICATION / APLICACIÓN:

Toyota: Land Cruiser

Lexus: LX470

PS: set of GS2001

GS2011 // NEW //

FRONT WHEEL SENSOR (RIGHT SIDE)



REPLACES / REEMPLAZA:

BMW: 34526752682, 34526792896, 0986594528; **Bosch:** 0 986 594 528; **Delphi:** SS20042; **Cargo:** 182300;

Meat & Doria: 90139; **Mobiletron:** AB-EU093

APPLICATION / APLICACIÓN:

BMW: 3 316 i 1997>2005, 3 318 d 1997>2005, 3 318 i 1997>2005, 3 320 d 1997>2005, 3 320 i 1997>2005, 3 325 i 1997>2005, 3 330 d 1997>2005, 3 330 i 1997>2005, 3 330 i 2004>2011, 3 Compact 316 ti 2001>2005, 3 Compact 318 td 2001>2005, 3 Compact 318 ti 2001>2005, 3 Compact 320 td 2001>2005, 3 Compact 325 ti 2001>2005, 3 Convertible 318 Ci 2000>2007, 3 Convertible 320 Cd 2000>2007, 3 Convertible 320 Ci 2000>2007, 3 Convertible 325 Ci 2000>2007, 3 Convertible 330 Cd 2000>2007, 3 Convertible 330 Ci 2000>2007, 3 Convertible M3 2000>2007, 3 Coupe 316 Ci 1998>2006, 3 Coupe 318 Ci 1998>2006, 3 Coupe 320 Cd 1998>2006, 3 Coupe 320 Ci 1998>2006, 3 Coupe 325 Ci 1998>2006, 3 Coupe 330 Cd 1998>2006, 3 Coupe 330 Ci 1998>2006, 3 Coupe M3 1998>2006, 3 Touring 316 i 1999>2005, 3 Touring 318 d 1999>2005, 3 Touring 318 i 1999>2005, 3 Touring 320 d 1999>2005, 3 Touring 320 i 1999>2005, 3 Touring 325 i 1999>2005, 3 Touring 330 d 1999>2005, 3 Touring 330 i 1999>2005, Z4 Coupe 3.0 si 2006>2009, Z4 Coupe M 2006>2009, Z4 Roadster 2.0 i 2002>2009, Z4 Roadster 2.2 i 2002>2009, Z4 Roadster 2.5 i 2002>2009, Z4 Roadster 2.5 si 2002>2009, Z4 Roadster 3.0 i 2002>2009, Z4 Roadster 3.0 si 2002>2009, Z4 Roadster M 2002>2009, 3 323 i 1997>2005, 3 325 xi 1997>2005, 3 328 i 1997>2005, 3 330 xd 1997>2005, 3 330 xi 1997>2005, 3 Convertible 323 Ci 2000>2007, 3 Coupe 323 Ci 1998>2006, 3 Coupe 328 Ci 1998>2006, 3 Coupe 330 xi 1998>2006, 3 Touring 325 xi 1999>2005, 3 Touring 328 i 1999>2005, 3 Touring 330 xd 1999>2005, 3 Touring 330 xi 1999>2005, BMW BRIL: 3 SERIES 318 i 2004>2005

GS2012 // NEW //

FRONT WHEEL SENSOR (LEFT SIDE)



REPLACES / REEMPLAZA:

BMW: 34526752681, 34526792897, 0986594527; **Bosch:** 0 986 594 527; **Delphi:** SS20041; **Cargo:** 182297;

Meat & Doria: 90138; **Mobiletron:** AB-EU092

APPLICATION / APLICACIÓN:

BMW: 3 316 i 1997>2005, 3 318 d 1997>2005, 3 318 i 1997>2005, 3 320 d 1997>2005, 3 320 i 1997>2005, 3 325 i 1997>2005, 3 330 d 1997>2005, 3 330 i 1997>2005, 3 330 i 2004>2011, 3 Compact 316 ti 2001>2005, 3 Compact 318 td 2001>2005, 3 Compact 318 ti 2001>2005, 3 Compact 320 td 2001>2005, 3 Compact 325 ti 2001>2005, 3 Convertible 318 Ci 2000>2007, 3 Convertible 320 Cd 2000>2007, 3 Convertible 320 Ci 2000>2007, 3 Convertible 325 Ci 2000>2007, 3 Convertible 330 Cd 2000>2007, 3 Convertible 330 Ci 2000>2007, 3 Convertible M3 2000>2007, 3 Coupe 316 Ci 1998>2006, 3 Coupe 318 Ci 1998>2006, 3 Coupe 320 Cd 1998>2006, 3 Coupe 320 Ci 1998>2006, 3 Coupe 325 Ci 1998>2006, 3 Coupe 330 Cd 1998>2006, 3 Coupe 330 Ci 1998>2006, 3 Coupe M3 1998>2006, 3 Touring 316 i 1999>2005, 3 Touring 318 d 1999>2005, 3 Touring 318 i 1999>2005, 3 Touring 320 d 1999>2005, 3 Touring 320 i 1999>2005, 3 Touring 325 i 1999>2005, 3 Touring 330 d 1999>2005, 3 Touring 330 i 1999>2005, Z4 Coupe 3.0 si 2006>2009, Z4 Coupe M 2006>2009, Z4 Roadster 2.0 i 2002>2009, Z4 Roadster 2.2 i 2002>2009, Z4 Roadster 2.5 i 2002>2009, Z4 Roadster 2.5 si 2002>2009, Z4 Roadster 3.0 i 2002>2009, Z4 Roadster 3.0 si 2002>2009, Z4 Roadster M 2002>2009, 3 323 i 1997>2005, 3 325 xi 1997>2005, 3 328 i 1997>2005, 3 330 xd 1997>2005, 3 330 xi 1997>2005, 3 Convertible 323 Ci 2000>2007, 3 Coupe 323 Ci 1998>2006, 3 Coupe 328 Ci 1998>2006, 3 Coupe 330 xi 1998>2006, 3 Touring 325 xi 1999>2005, 3 Touring 328 i 1999>2005, 3 Touring 330 xd 1999>2005, 3 Touring 330 xi 1999>2005, BMW BRIL: 3 SERIES 318 i 2004>2005

GS2013 // NEW //
REAR WHEEL SENSOR (BOTH SIDES)

REPLACES / REEMPLAZA:
BMW: 34526752683, 0986594513, 34526752702; **Bosch:** 0 986 594 513; **Delphi:** SS20097; **Cargo:** 182299; **Meat & Doria:** 90140; **Mobiletron:** AB-EU043

APPLICATION / APLICACIÓN:
BMW: 3 316 i 1997>2005, 3 318 d 1997>2005, 3 318 i 1997>2005, 3 320 d 1997>2005, 3 320 i 1997>2005, 3 323 i 1997>2005, 3 325 i 1997>2005, 3 325 xi 1997>2005, 3 330 i 1997>2005, 3 330 xd 1997>2005, 3 330 xi 1997>2005, 3 330 i 2004>2011, 3 Compact 316 ti 2001>2005, 3 Compact 318 td 2001>2005, 3 Compact 318 ti 2001>2005, 3 Compact 320 td 2001>2005, 3 Compact 325 ti 2001>2005, 3 Convertible 318 Ci 2000>2007, 3 Convertible 320 Cd 2000>2007, 3 Convertible 320 Ci 2000>2007, 3 Convertible 323 Ci 2000>2007, 3 Convertible 325 Ci 2000>2007, 3 Convertible 330 Ci 2000>2007, 3 Convertible M3 2000>2007, 3 Coupe 316 Ci 1998>2006, 3 Coupe 318 Ci 1998>2006, 3 Coupe 320 Cd 1998>2006, 3 Coupe 320 Ci 1998>2006, 3 Coupe 323 Ci 1998>2006, 3 Coupe 325 Ci 1998>2006, 3 Coupe 330 Ci 1998>2006, 3 Coupe M3 1998>2006, 3 Touring 316 i 1999>2005, 3 Touring 318 d 1999>2005, 3 Touring 318 i 1999>2005, 3 Touring 320 d 1999>2005, 3 Touring 320 i 1999>2005, 3 Touring 323 i 1999>2005, 3 Touring 325 i 1999>2005, 3 Touring 330 i 1999>2005, 3 328 i 1997>2005, 3 330 d 1997>2005, 3 Convertible 330 Cd 2000>2007, 3 Coupe 328 Ci 1998>2006, 3 Coupe 330 Cd 1998>2006, 3 Coupe 330 xi 1998>2006, 3 Touring 325 xi 1999>2005, 3 Touring 330 d 1999>2005, 3 Touring 330 xd 1999>2005, 3 Touring 330 xi 1999>2005, BMW BRIL: 3 SERIES 318 i 2004>2005

GS2014
REAR WHEEL SENSOR

REPLACES / REEMPLAZA:
GM: 94769014

APPLICATION / APLICACIÓN:
GM: Agile, Celta, Prisma, Spin

PS: set of GS2015

GS2015
FRONT WHEEL SENSOR

REPLACES / REEMPLAZA:
GM: 94769015

APPLICATION / APLICACIÓN:
GM: Agile, Celta, Prisma, Spin

PS: set of GS2014

GS2016 // NEW //
FRONT WHEEL SENSOR (BOTH SIDES)

REPLACES / REEMPLAZA:
Audi: 4B0927803, 4B0927803 with 4B0927803A, 0986594006, 0986594007; **Bosch:** 0 986 594 006; **Delphi:** SS20125; **Meat & Doria:** 90052; **Mobiletron:** AB-EU113

APPLICATION / APLICACIÓN:
AUDI: A6 2.8 1995>1997, A6 1.8 1997>2005, A6 1.8 T 1997>2005, A6 1.8 T quattro 1997>2005, A6 1.9 TDI 1997>2005, A6 2.4 1997>2005, A6 2.4 quattro 1997>2005, A6 2.5 TDI 1997>2005, A6 2.5 TDI quattro 1997>2005, A6 2.7 T quattro 1997>2005, A6 2.8 1997>2005, A6 2.8 quattro 1997>2005, A6 Avant 1.8 1997>2005, A6 Avant 1.8 T 1997>2005, A6 Avant 1.8 T quattro 1997>2005, A6 Avant 1.9 TDI 1997>2005, A6 Avant 2.4 1997>2005, A6 Avant 2.4 quattro 1997>2005, A6 Avant 2.5 TDI 1997>2005, A6 Avant 2.5 TDI quattro 1997>2005, A6 Avant 2.8 1997>2005, A6 Avant 2.8 quattro 1997>2005, A6 Avant 2.7 T quattro 1997>2005

GS2017 // NEW //
FRONT WHEEL SENSOR (LEFT SIDE)

REPLACES / REEMPLAZA:
Honda: B07H17, 57455-TEAT01

APPLICATION / APLICACIÓN:
HONDA: Civic X Hatchback 1.5 VTEC 2017>

GS2018 // NEW //
FRONT WHEEL SENSOR (RIGHT SIDE)

REPLACES / REEMPLAZA:
Honda: B07H18, 57450-TEAT01

APPLICATION / APLICACIÓN:
HONDA: Civic X Hatchback 1.5 VTEC 2017>

PS: set of GS2017, GS2019 and GS2020

GS2019 // NEW //
REAR WHEEL SENSOR (LEFT SIDE)

REPLACES / REEMPLAZA:
Honda: 47560-TEAT01

APPLICATION / APLICACIÓN:
HONDA: Civic X Hatchback 1.5 VTEC 2017>

PS: set of GS2017, GS2018 and GS2020

GS2020 // NEW //
REAR WHEEL SENSOR (RIGHT SIDE)

REPLACES / REEMPLAZA:
Honda: 47510-TEAT01

APPLICATION / APLICACIÓN:
HONDA: Civic Touring CVT 1.5 Turbo 2017>2019

PS: set of GS2017, GS2018 and GS2019

GS2030
FRONT WHEEL SENSOR (LEFT SIDE)

REPLACES / REEMPLAZA:
Honda: 57455S4KA52, 57455S84A51, 57455S84A52

APPLICATION / APLICACIÓN:
Honda: Accord Mk7 Coupe 2.0i 16v, Accord 2.3 1997>2003

PS: set of GS2031

GS2021 // NEW //

FRONT AND REAR WHEEL SENSOR (RIGHT SIDE)

REPLACES / REEMPLAZA:

VW: 7H0927804, WHT003856, WHT003856A, 0986594505, 7L0927808A, 7L0927808B, 0986594525; **Bosch:** 0 986 594 505; **Delphi:** SS20036;

Meat & Doria: 90061, 90061E; **Mobiletron:** AB-EU050

APPLICATION / APLICACIÓN:

AUDI: A1 1.0 TFSI 2010>2018, A1 1.4 TDI 2010>2018, A1 1.4 TFSI 2010>2018, A1 1.4 TSI 2010>2018, A1 1.6 TDI 2010>2018, A1 1.8 TFSI 2010>2018, A1 S1 quattro 2010>2018, A1 Sportback 1.0 TFSI 2011>2018, A1 Sportback 1.4 TDI 2011>2018, A1 Sportback 1.4 TFSI 2011>2018, A1 Sportback 1.4 TSI 2011>2018, A1 Sportback 1.6 TDI 2011>2018, A1 Sportback 1.8 TFSI 2011>2018, A1 Sportback S1 quattro 2011>2018, A3 1.2 TSI 2003>2012, A3 1.4 TFSI 2003>2012, A3 1.6 2003>2012, A3 1.6 E-Power 2003>2012, A3 1.6 FSI 2003>2012, A3 1.6 TDI 2003>2012, A3 1.8 TFSI 2003>2012, A3 1.8 TFSI quattro 2003>2012, A3 1.9 TDI 2003>2012, A3 2.0 FSI 2003>2012, A3 2.0 TDI 2003>2012, A3 2.0 TDI 16V 2003>2012, A3 2.0 TDI 16V quattro 2003>2012, A3 2.0 TDI quattro 2003>2012, A3 2.0 TFSI 2003>2012, A3 2.0 TFSI quattro 2003>2012, A3 3.2 V6 quattro 2003>2012, A3 S3 quattro 2003>2012, A3 1.8 TFSI quattro 2012>1900, A3 2.0 TDI quattro 2012>1900, A3 2.0 TFSI quattro 2012>1900, A3 S3 quattro 2012>1900, A3 Convertible 1.2 TFSI 2008>2013, A3 Convertible 1.4 TFSI 2008>2013, A3 Convertible 1.6 2008>2013, A3 Convertible 1.6 TDI 2008>2013, A3 Convertible 1.8 TFSI 2008>2013, A3 Convertible 1.9 TDI 2008>2013, A3 Convertible 2.0 TDI 2008>2013, A3 Convertible 2.0 TFSI 2008>2013, A3 Convertible 1.8 TFSI quattro 2014>1900, A3 Convertible 2.0 TDI quattro 2014>1900, A3 Convertible 2.0 TFSI quattro 2014>1900, A3 Convertible 40 TFSI 2014>1900, A3 Convertible S3 quattro 2014>1900, A3 Limousine 1.6 TDI quattro 2013>2019, A3 Limousine 1.8 TFSI quattro 2013>2019, A3 Limousine 2.0 TDI quattro 2013>2019, A3 Limousine 2.0 TFSI quattro 2013>2019, A3 Limousine S3 quattro 2013>2019, A3 Sportback 1.2 TSI 2004>2013, A3 Sportback 1.4 TFSI 2004>2013, A3 Sportback 1.6 2004>2013, A3 Sportback 1.6 E-Power 2004>2013, A3 Sportback 1.6 FSI 2004>2013, A3 Sportback 1.6 TDI 2004>2013, A3 Sportback 1.8 TFSI 2004>2013, A3 Sportback 1.8 TFSI quattro 2004>2013, A3 Sportback 1.9 TDI 2004>2013, A3 Sportback 2.0 FSI 2004>2013, A3 Sportback 2.0 TDI 2004>2013, A3 Sportback 2.0 TDI 16V 2004>2013, A3 Sportback 2.0 TDI 16V quattro 2004>2013, A3 Sportback 2.0 TDI quattro 2004>2013, A3 Sportback 2.0 TFSI 2004>2013, A3 Sportback 2.0 TFSI quattro 2004>2013, A3 Sportback 3.2 V6 quattro 2004>2013, A3 Sportback RS3 quattro 2004>2013, A3 Sportback 1.6 TDI quattro 2012>2018, A3 Sportback 1.8 TFSI quattro 2012>2018, A3 Sportback 2.0 TDI quattro 2012>2018, A3 Sportback 2.0 TFSI quattro 2012>2018, A3 Sportback S3 quattro 2012>2018, Q3 1.4 TFSI 2011>2018, Q3 1.4 TSI 2011>2018, Q3 2.0 TDI 2011>2018, Q3 2.0 TDI quattro 2011>2018, Q3 2.0 TFSI 2011>2018, Q3 2.0 TFSI quattro 2011>2018, Q3 RS 2.5 quattro 2011>2018, Q3 RS perparance 2.5 quattro 2011>2018, TT 1.8 TFSI 2006>2014, TT 2.0 TDI quattro 2006>2014, TT 2.0 TFSI 2006>2014, TT 2.0 TFSI quattro 2006>2014, TT 2.0 TFSI quattro 2006>2014, TT 2.0 TFSI quattro 2006>2014, TT 2.5 RS quattro 2006>2014, TT 3.2 V6 quattro 2006>2014, TT Roadster 1.8 TFSI 2007>2014, TT Roadster 2.0 TDI quattro 2007>2014, TT Roadster 2.0 TFSI 2007>2014, TT Roadster 2.0 TFSI quattro 2007>2014, TT Roadster 2.0 TFSI quattro 2007>2014, TT Roadster 2.5 RS quattro 2007>2014, TT Roadster 3.2 V6 quattro 2007>2014, A3 1.8 T 2003>2012, A3 Convertible 40 TFSI quattro 2014>1900, A3 Limousine 40 TDI quattro 2013>2019, A3 Limousine 40 TFSI quattro 2013>2019, A3 Limousine RS3 quattro 2013>2019, A3 Sportback 40 TDI quattro 2012>2018, A3 Sportback 40 TFSI quattro 2012>2018, A3 Sportback RS3 quattro 2012>2018, Q3 1.4 TFSI Flex 2011>2018, TT 2.0 TFSI 2014>1900, TT 2.0 TFSI quattro 2014>1900, TT 2.0 TFSI quattro 2014>1900, TT Roadster 2.0 TFSI 2014>1900, TT Roadster 2.0 TFSI quattro 2014>1900, TT Roadster 2.0 TFSI quattro 2014>1900, TT Roadster 2.0 TFSI quattro 2014>1900, SEAT: ALHAMBRA 1.4 TSI 2010>2011, ALHAMBRA 1.8 TSI 2010>2011, ALHAMBRA 2.0 TDI 2010>2011, ALHAMBRA 2.0 TDI 4Drive 2010>2011, ALHAMBRA 2.0 TSI 2010>2011, ALTEA 1.2 TSI 2004>2011, ALTEA 1.4 16V 2004>2011, ALTEA 1.4 TSI 2004>2011, ALTEA 1.6 2004>2011, ALTEA 1.6 LPG 2004>2011, ALTEA 1.6 Multifuel 2004>2011, ALTEA 1.6 TDI 2004>2011, ALTEA 1.8 TFSI 2004>2011, ALTEA 1.9 TDI 2004>2011, ALTEA 2.0 FSI 2004>2011, ALTEA 2.0 TDI 2004>2011, ALTEA 2.0 TDI 16V 2004>2011, ALTEA 2.0 TFSI 2004>2011, ALTEA XL 1.2 TSI 2006>2010, ALTEA XL 1.4 16V 2006>2010, ALTEA XL 1.4 TSI 2006>2010, ALTEA XL 1.6 2006>2010, ALTEA XL 1.6 LPG 2006>2010, ALTEA XL 1.6 Multifuel 2006>2010, ALTEA XL 1.6 TDI 2006>2010, ALTEA XL 1.8 TFSI 2006>2010, ALTEA XL 1.9 TDI 2006>2010, ALTEA XL 1.9 TDI 4x4 2006>2010, ALTEA XL 2.0 FSI 2006>2010, ALTEA XL 2.0 TDI 2006>2010, ALTEA XL 2.0 TDI 16V 2006>2010, ALTEA XL 2.0 TDI 16V 4x4 2006>2010, ALTEA XL 2.0 TDI 4x4 2006>2010, ALTEA XL 2.0 TFSI 2006>2010, ALTEA XL 2.0 TFSI 4x4 2006>2010, LEON 1.2 TSI 2005>2012, LEON 1.4 16V 2005>2012, LEON 1.4 TSI 2005>2012, LEON 1.6 2005>2012, LEON 1.6 LPG 2005>2012, LEON 1.6 Multifuel 2005>2012, LEON 1.6 TDI 2005>2012, LEON 1.8 TSI 2005>2012, LEON 1.9 TDI 2005>2012, LEON 2.0 Cupra R 2005>2012, LEON 2.0 FSI 2005>2012, LEON 2.0 TDI 2005>2012, LEON 2.0 TDI 16V 2005>2012, LEON 2.0 TFSI 2005>2012, LEON ST 1.6 TDI 4Drive 2014>1900, LEON ST 1.8 TSI 4Drive 2014>1900, LEON ST 2.0 TDI 4Drive 2014>1900, LEON ST Box Body/Estate 2.0 TDI 4Drive 2014>1900, TOLEDO III 1.4 16V 2004>2009, TOLEDO III 1.4 TSI 2004>2009, TOLEDO III 1.6 2004>2009, TOLEDO III 1.8 TFSI 2004>2009, TOLEDO III 1.9 TDI 2004>2009, TOLEDO III 2.0 FSI 2004>2009, TOLEDO III 2.0 TDI 2004>2009, TOLEDO III 2.0 TDI 16V 2004>2009, TOLEDO III 2.0 TFSI 2004>2009, ALTEA 2.0 TDI 16V 4WD 2004>2011, LEON ST 2.0 Cupra 4Drive 2014>1900, LEON ST 2.0 TSI 4Drive 2014>1900;

VW: AMAROK 2.0 BITDI 2010>2016, AMAROK 2.0 BITDI 4motion 2010>2016, AMAROK 2.0 TDI 2010>2016, AMAROK 2.0 TDI 4motion 2010>2016, AMAROK 2.0 TSI 2010>2016, AMAROK 3.0 TDI 2010>2016, AMAROK 3.0 TDI 4motion 2010>2016, AMAROK Platparam/Chassis 2.0 TDI 2011>2016, AMAROK Platparam/Chassis 2.0 TDI 4motion 2011>2016, AMAROK Platparam/Chassis 3.0 TSI 2011>2016, AMAROK Platparam/Chassis 3.0 TDI 4motion 2011>2016, BEETLE 1.2 TSI 2011>2019, BEETLE 1.2 TSI 16V 2011>2019, BEETLE 1.4 TSI 2011>2019, BEETLE 1.6 TDI 2011>2019, BEETLE 2.0 TDI 2011>2019, BEETLE 2.0 TSI 2011>2019, BEETLE Convertible 1.2 TSI 2011>2019, BEETLE Convertible 1.2 TSI 16V 2011>2019, BEETLE Convertible 1.4 TSI 2011>2019, BEETLE Convertible 1.6 TDI 2011>2019, BEETLE Convertible 2.0 TDI 2011>2019, BEETLE Convertible 2.0 TSI 2011>2019, CADDY ALLTRACK Box 1.2 TSI 2015>2017, CADDY ALLTRACK Box 1.4 TSI 2015>2017, CADDY ALLTRACK Box 1.4 TGI CNG 2015>2017, CADDY ALLTRACK Box 1.4 TSI 2015>2017, CADDY ALLTRACK Box 1.6 TDI 2015>2017, CADDY ALLTRACK Box 2.0 TDI 2015>2017, CADDY ALLTRACK Box 2.0 TDI 4motion 2015>2017, CADDY ALLTRACK Estate 1.0 TSI 2015>2017, CADDY ALLTRACK Estate 1.2 TSI 2015>2017, CADDY ALLTRACK Estate 1.4 TGI CNG 2015>2017, CADDY ALLTRACK Estate 1.4 TSI 2015>2017, CADDY ALLTRACK Estate 1.6 TDI 2015>2017, CADDY ALLTRACK Estate 2.0 TDI 2015>2017, CADDY ALLTRACK Estate 2.0 TDI 4motion 2015>2017, CADDY III Box 1.2 TSI 2004>2015, CADDY III Box 1.4 2004>2015, CADDY III Box 1.6 2004>2015, CADDY III Box 1.6 BiFuel 2004>2015, CADDY III Box 1.6 TDI 2004>2015, CADDY III Box 1.9 TDI 2004>2015, CADDY III Box 1.9 TDI 4motion 2004>2015, CADDY III Box 2.0 EcoFuel 2004>2015, CADDY III Box 2.0 SDI 2004>2015, CADDY III Box 2.0 TDI 2004>2015, CADDY III Box 2.0 TDI 16V 2004>2015, CADDY III Box 2.0 TDI 4motion 2004>2015, CADDY III Estate 1.2 TSI 2004>2015, CADDY III Estate 1.4 2004>2015, CADDY III Estate 1.6 2004>2015, CADDY III Estate 1.6 BiFuel 2004>2015, CADDY III Estate 1.6 TDI 2004>2015, CADDY III Estate 1.9 TDI 2004>2015, CADDY III Estate 1.9 TDI 4motion 2004>2015, CADDY III Estate 2.0 EcoFuel 2004>2015, CADDY III Estate 2.0 SDI 2004>2015, CADDY III Estate 2.0 TDI 2004>2015, CADDY III Estate 2.0 TDI 16V 2004>2015, CADDY III Estate 2.0 TDI 16V 4motion 2004>2015, CADDY III Estate 2.0 TDI 4motion 2004>2015, CADDY IV Box 1.0 TSI 2015>2017, CADDY IV Box 1.2 TSI 2015>2017, CADDY IV Box 1.4 TGI CNG 2015>2017, CADDY IV Box 1.4 TSI 2015>2017, CADDY IV Box 1.6 2015>2017, CADDY IV Box 1.6 TDI 2015>2017, CADDY IV Box 2.0 TDI 2015>2017, CADDY IV Box 2.0 TDI 4motion 2015>2017, CADDY IV Estate 1.0 TSI 2015>2017, CADDY IV Estate 1.2 TSI 2015>2017, CADDY IV Estate 1.4 TGI CNG 2015>2017, CADDY IV Estate 1.4 TSI 2015>2017, CADDY IV Estate 1.6 2015>2017, CADDY IV Estate 1.6 TDI 2015>2017, CADDY IV Estate 2.0 TDI 2015>2017, CC 1.4 TSI 2011>2016, CC 1.4 TSI Multifuel 2011>2016, CC 1.8 TSI 2011>2016, CC 2.0 TDI 2011>2016, CC 2.0 TDI 4motion 2011>2016, CC 2.0 TSI 2011>2016, CC 3.6 FSI 4motion 2011>2016, CRAFTER Box 2.0 TDI 2016>1900, CRAFTER Box 2.0 TDI 4motion 2016>1900, CRAFTER Box 2.0 TDI RWD 2016>1900, CRAFTER Box e-Crafter 2016>1900, CRAFTER Bus 2.0 TDI 2016>1900, CRAFTER Bus 2.0 TDI 4motion 2016>1900, CRAFTER Platparam/Chassis 2.0 TDI 2016>1900, CRAFTER Platparam/Chassis 2.0 TDI 4motion 2016>1900, CRAFTER Platparam/Chassis 2.0 TDI RWD 2016>1900, EOS 1.4 TSI 2006>2015, EOS 1.6 FSI 2006>2015, EOS 2.0 FSI 2006>2015, EOS 2.0 TDI 2006>2015, EOS 2.0 TDI 16V 2006>2015, EOS 2.0 TFSI 2006>2015, EOS 2.0 TSI 2006>2015, EOS 3.2 V6 2006>2015, EOS 3.6 V6 2006>2015, GOLF ALLTRACK VII 1.6 TDI 4motion 2014>2018, GOLF ALLTRACK VII 2.0 TDI 4motion 2014>2018, GOLF PLUS 1.2 TSI 2004>2013, GOLF PLUS 1.4 16V 2004>2013, GOLF PLUS 1.4 FSI 2004>2013, GOLF PLUS 1.4 TSI 2004>2013, GOLF PLUS 1.6 2004>2013, GOLF PLUS 1.6 BiFuel 2004>2013, GOLF PLUS 1.6 FSI 2004>2013, GOLF PLUS 1.6 Multifuel 2004>2013, GOLF PLUS 1.6 TDI 2004>2013, GOLF PLUS 1.2 TSI 2004>2013, GOLF PLUS 1.4 16V 2004>2013, GOLF PLUS 1.4 FSI 2004>2013, GOLF PLUS 1.4 TSI 2004>2013, GOLF PLUS 1.6 2004>2013, GOLF PLUS 1.6 BiFuel 2004>2013, GOLF PLUS 1.6 FSI 2004>2013, GOLF PLUS 1.6 Multifuel 2004>2013, GOLF PLUS 1.6 TDI 2004>2013, GOLF PLUS 2.0 FSI 2004>2013, GOLF PLUS 2.0 TDI 2004>2013, GOLF PLUS 2.0 TDI 16V 2004>2013, GOLF PLUS Van 1.2 TSI 2009>2014, GOLF PLUS Van 1.4 TSI 2009>2014, GOLF PLUS Van 1.6 TDI 2009>2014, GOLF PLUS Van 2.0 TDI 2009>2014, GOLF V 1.4 16V 2003>2009, GOLF V 1.4 FSI 2003>2009, GOLF V 1.4 TSI 2003>2009, GOLF V 1.6 2003>2009, GOLF V 1.6 FSI 2003>2009, GOLF V 1.6 Multifuel 2003>2009, GOLF V 1.9 TDI 2003>2009, GOLF V 1.9 TDI 4motion 2003>2009, GOLF V 2.0 2003>2009, GOLF V 2.0 FSI 2003>2009, GOLF V 2.0 FSI 4motion 2003>2009, GOLF V 2.0 GTI 2003>2009, GOLF V 2.0 SDI 2003>2009, GOLF V 2.0 TDI 2003>2009, GOLF V 2.0 TDI 16V 2003>2009, GOLF V 2.0 TDI 16V 4motion 2003>2009, GOLF V 2.0 TDI 4motion 2003>2009, GOLF V 3.2 R32 4motion 2003>2009, GOLF V Variant 1.4 2007>2009, GOLF V Variant 1.4 TSI 2007>2009, GOLF V Variant 1.6 2007>2009, GOLF V Variant 1.6 Multifuel 2007>2009, GOLF V Variant 1.9 TDI 4motion 2007>2009, GOLF V Variant 1.9 TDI 4motion 2007>2009, GOLF V Variant 2.0 2007>2009, GOLF V Variant 2.0 TDI 2007>2009, GOLF V Variant 2.0 TDI 16V 2007>2009, GOLF V Variant 2.5 2007>2009, GOLF VAN VI Variant 1.2 TSI 2009>2014, GOLF VAN VI Variant 1.4 TSI 2009>2014, GOLF VAN VI Variant 1.6 TDI 2009>2014, GOLF VAN VI Variant 1.6 TDI BlueMotion 2009>2014, GOLF VAN VI Variant 2.0 TDI 2009>2014, GOLF VAN VII Variant 1.6 TDI BlueMotion 4motion 2013>2017...

CONTINUE...



**GS2021 // NEW //****FRONT AND REAR WHEEL SENSOR (RIGHT SIDE)****REPLACES / REEMPLAZA:****VW:** 7H0927804, WHT003856, WHT003856B, WHT003856A, 0986594505, 7L0927808A, 7L0927808B, 0986594525; **Bosch:** 0 986 594 505; **Delphi:** SS20036;**Meat & Doria:** 90061, 90061E; **Mobiletron:** AB-EU050**APPLICATION / APLICACION:**

...**VW:** GOLF Van VII Variant 2.0 TDi BlueMotion 4motion 2013>2017, GOLF VI 1.2 TSI 2008>2013, GOLF VI 1.4 2008>2013, GOLF VI 1.4 TSI 2008>2013, GOLF VI 1.6 2008>2013, GOLF VI 1.6 BiFuel 2008>2013, GOLF VI 1.6 MultiFuel 2008>2013, GOLF VI 1.6 TDI 2008>2013, GOLF VI 1.8 TSI 2008>2013, GOLF VI 2.0 GTI 2008>2013, GOLF VI 2.0 R 4motion 2008>2013, GOLF VI 2.0 TDI 2008>2013, GOLF VI 2.0 TDI 4motion 2008>2013, GOLF VI Convertible 1.2 TSI 2011>2016, GOLF VI Convertible 1.2 TSI 16V 2011>2016, GOLF VI Convertible 1.4 TSI 2011>2016, GOLF VI Convertible 1.6 TDI 2011>2016, GOLF VI Convertible 2.0 GTI 2011>2016, GOLF VI Convertible 2.0 R 2011>2016, GOLF VI Convertible 2.0 TDI 2011>2016, GOLF VI Convertible 2.0 TDI 4motion 2011>2016, GOLF VI Van 1.2 TSI 2008>2012, GOLF VI Van 1.2 TSI BlueMotion 2008>2012, GOLF VI Van 1.4 TSI 2008>2012, GOLF VI Van 1.6 TDI 2008>2012, GOLF VI Van 1.6 TDI BlueMotion 2008>2012, GOLF VI Van 2.0 GTI 2008>2012, GOLF VI Van 2.0 TDI 2008>2012, GOLF VI Van 2.0 TSi R 4motion 2008>2012, GOLF VI Van TSi 2008>2012, GOLF VI Variant 1.2 TSI 2009>2014, GOLF VI Variant 1.4 2009>2014, GOLF VI Variant 1.4 TSI 2009>2014, GOLF VI Variant 1.6 2009>2014, GOLF VI Variant 1.6 2009>2014, GOLF VI Variant 1.6 BiFuel 2009>2014, GOLF VI Variant 1.6 MultiFuel 2009>2014, GOLF VI Variant 1.6 TDI 2009>2014, GOLF VI Variant 1.6 TDI 4motion 2009>2014, GOLF VI Variant 2.0 TDI 2009>2014, GOLF VI Variant 2.0 TSI 2009>2014, GOLF VI Variant 2.5 2009>2014, GOLF VII 1.6 TDI 4motion 2012>1900, GOLF VII 2.0 GTI 2012>1900, GOLF VII 2.0 R 4motion 2012>1900, GOLF VII 2.0 TDI 2012>1900, GOLF VII 2.0 TDI 4motion 2012>1900, GOLF VII Van 2.0 GTI 2013>1900, GOLF VII Variant 2.0 TDI BlueMotion 4motion 2013>1900, GOLF VII Variant 1.6 TDI 4motion 2013>2018, GOLF VII Variant 2.0 TDI 4motion 2013>2018, GRAND CALIPARAÑIA Camper 2.0 TDI 2019>1900, GRAND CALIPARAÑIA Camper 2.0 TDI 4motion 2019>1900, JETTA III 1.4 TSI 2004>2010, JETTA III 1.6 2004>2010, JETTA III 1.6 FSI 2004>2010, JETTA III 1.6 MultiFuel 2004>2010, JETTA III 1.6 TDI 2004>2010, JETTA III 1.9 TDI 2004>2010, JETTA III 2.0 FSI 2004>2010, JETTA III 2.0 TDI 2004>2010, JETTA III 2.0 TDI 16V 2004>2010, JETTA III 2.0 TFSI 2004>2010, JETTA III 2.5 2004>2010, JETTA IV 1.2 TSI 2010>2018, JETTA IV 1.2 TSI 16V 2010>2018, JETTA IV 1.4 TSI 2010>2018, JETTA IV 1.4 TSI Hybrid 2010>2018, JETTA IV 1.6 2010>2018, JETTA IV 1.6 MPI 2010>2018, JETTA IV 1.6 TDI 2010>2018, JETTA IV 2.0 2010>2018, JETTA IV 2.0 Flex 2010>2018, JETTA IV 2.0 TDI 2010>2018, JETTA IV 2.0 TSI 2010>2018, JETTA Saloon 1.4 TSI 2017>1900, MULTIVAN V 1.9 TDI 2003>2015, MULTIVAN V 2.0 2003>2015, MULTIVAN V 2.0 BiTDI 2003>2015, MULTIVAN V 2.0 BiTDI 4motion 2003>2015, MULTIVAN V 2.0 TDI 2003>2015, MULTIVAN V 2.0 TDI 4motion 2003>2015, MULTIVAN V 2.0 TSI 2003>2015, MULTIVAN V 2.0 TSI 4motion 2003>2015, MULTIVAN V 2.5 TDI 2003>2015, MULTIVAN V 2.5 TDI 4motion 2003>2015, MULTIVAN V 3.2 V6 2003>2015, MULTIVAN V 3.2 V6 4motion 2003>2015, MULTIVAN VI 2.0 TDI 2015>1900, MULTIVAN VI 2.0 TDI 4motion 2015>1900, MULTIVAN VI 2.0 TSI 2015>1900, MULTIVAN VI 2.0 TSI 4motion 2015>1900, PASSAT 1.4 TSI 2010>2014, PASSAT 1.4 TSI EcoFuel 2010>2014, PASSAT 1.4 TSI MultiFuel 2010>2014, PASSAT 1.6 TDI 2010>2014, PASSAT 1.6 TDI 2010>2014, PASSAT 2.0 TDI 4motion 2010>2014, PASSAT 2.0 TSI 2010>2014, PASSAT 3.6 FSI 4motion 2010>2014, PASSAT 1.4 TSI 2005>2010, PASSAT 1.4 TSI EcoFuel 2005>2010, PASSAT 1.6 2005>2010, PASSAT 1.6 FSI 2005>2010, PASSAT 1.6 TDI 2005>2010, PASSAT 1.8 TSI 2005>2010, PASSAT 1.9 TDI 2005>2010, PASSAT 2.0 BlueTDI 2005>2010, PASSAT 2.0 FSI 2005>2010, PASSAT 2.0 FSI 4motion 2005>2010, PASSAT 2.0 TDI 2005>2010, PASSAT 2.0 TDI 16V 2005>2010, PASSAT 2.0 TDI 16V 4motion 2005>2010, PASSAT 2.0 TDI 4motion 2005>2010, PASSAT 3.2 FSI 4motion 2005>2010, PASSAT 3.6 R36 4motion 2005>2010, PASSAT 2.5 2011>1900, PASSAT ALLTRACK 1.8 TSI 2012>2014, PASSAT ALLTRACK 2.0 TDI 2012>2014, PASSAT ALLTRACK 2.0 TDI 4motion 2012>2014, PASSAT ALLTRACK 2.0 TSI 4motion 2012>2014, PASSAT Box Body/Estate 1.4 TSI BlueMotion 2010>2014, PASSAT Box Body/Estate 1.6 TDI BlueMotion 2010>2014, PASSAT Box Body/Estate 1.8 TFSI 2010>2014, PASSAT Box Body/Estate 2.0 TDI BlueMotion 2010>2014, PASSAT Box Body/Estate 2.0 TFSI 2010>2014, PASSAT Box Body/Estate 3.6 FSI 4motion 2010>2014, PASSAT CC 1.4 TSI MultiFuel 2008>2012, PASSAT CC 1.8 TSI 2008>2012, PASSAT CC 2.0 BlueTDI 2008>2012, PASSAT CC 2.0 TDI 2008>2012, PASSAT CC 2.0 TDI 4motion 2008>2012, PASSAT CC 2.0 TSI 2008>2012, PASSAT CC 3.6 FSI 2008>2012, PASSAT CC 3.6 FSI 4motion 2008>2012, PASSAT Variant 1.4 TSI 2010>2015, PASSAT Variant 1.4 TSI EcoFuel 2010>2015, PASSAT Variant 1.4 TSI 4motion 2010>2015, PASSAT Variant 1.4 TSI MultiFuel 2010>2015, PASSAT Variant 1.6 TDI 2010>2015, PASSAT Variant 1.8 TSI 2010>2015, PASSAT Variant 2.0 TDI 2010>2015, PASSAT Variant 2.0 TDI 4motion 2010>2015, PASSAT Variant 2.0 TSI 2010>2015, PASSAT Variant 3.6 FSI 4motion 2010>2015, PASSAT Variant 1.4 TSI 2005>2011, PASSAT Variant 1.4 TSI EcoFuel 2005>2011, PASSAT Variant 1.6 2005>2011, PASSAT Variant 1.6 FSI 2005>2011, PASSAT Variant 1.6 TDI 2005>2011, PASSAT Variant 1.8 TSI 2005>2011, PASSAT Variant 1.9 TDI 2005>2011, PASSAT Variant 2.0 BlueTDI 2005>2011, PASSAT Variant 2.0 FSI 2005>2011, PASSAT Variant 2.0 FSI 4motion 2005>2011, PASSAT Variant 2.0 TDI 2005>2011, PASSAT Variant 2.0 TDI 16V 2005>2011, PASSAT Variant 2.0 TDI 16V 4motion 2005>2011, PASSAT Variant 2.0 TDI 4motion 2005>2011, PASSAT Variant 3.2 FSI 4motion 2005>2011, PASSAT Variant 3.6 R36 4motion 2005>2011, SCIROCCO 1.4 TSI 2008>2017, SCIROCCO 2.0 R 2008>2017, SCIROCCO 2.0 TDI 2008>2017, SCIROCCO 2.0 TSI 2008>2017, SCIROCCO Van 1.4 TSI 2008>2014, SCIROCCO Van 2.0 TFSI 2008>2014, SHARAN 1.4 TSI 2010>1900, SHARAN 2.0 TDI 2010>1900, SHARAN 2.0 TDI 4motion 2010>1900, SHARAN 2.0 TSI 2010>1900, TIGUAN 1.4 TSI 2007>2018, TIGUAN 1.4 TSI 4motion 2007>2018, TIGUAN 2.0 TDI 2007>2018, TIGUAN 2.0 TDI 4motion 2007>2018, TIGUAN 2.0 TFSI 2007>2018, TIGUAN 2.0 TFSI 4motion 2007>2018, TOURAN 1.4 FSI 2003>2010, TOURAN 1.4 TSI 2003>2010, TOURAN 1.4 TSI EcoFuel 2003>2010, TOURAN 1.4 TSI EcoFuel 2003>2010, TOURAN 1.6 2003>2010, TOURAN 1.6 BiFuel 2003>2010, TOURAN 1.6 FSI 2003>2010, TOURAN 1.9 TDI 2003>2010, TOURAN 2.0 EcoFuel 2003>2010, TOURAN 2.0 FSI 2003>2010, TOURAN 2.0 TDI 2003>2010, TOURAN 2.0 TDI 16V 2003>2010, TOURAN 1.2 TSI 2010>2015, TOURAN 1.4 TSI 2010>2015, TOURAN 1.4 TSI EcoFuel 2010>2015, TOURAN 1.6 TDI 2010>2015, TOURAN 2.0 TDI 2010>2015, TRANSPORTER V Box 1.9 TDI 2003>2015, TRANSPORTER V Box 2.0 2003>2015, TRANSPORTER V Box 2.0 BiFuel 2003>2015, TRANSPORTER V Box 2.0 BiTDI 2003>2015, TRANSPORTER V Box 2.0 BiTDI 4motion 2003>2015, TRANSPORTER V Box 2.0 TDI 2003>2015, TRANSPORTER V Box 2.0 TDI 4motion 2003>2015, TRANSPORTER V Box 2.0 TSI 2003>2015, TRANSPORTER V Box 2.0 TSI 4motion 2003>2015, TRANSPORTER V Box 2.5 TDI 2003>2015, TRANSPORTER V Box 2.5 TDI 4motion 2003>2015, TRANSPORTER V Box 3.2 4motion 2003>2015, TRANSPORTER V Box 3.2 V6 2003>2015, TRANSPORTER V Bus 1.9 TDI 2003>2015, TRANSPORTER V Bus 2.0 2003>2015, TRANSPORTER V Bus 2.0 BiTDI 2003>2015, TRANSPORTER V Bus 2.0 TDI 2003>2015, TRANSPORTER V Bus 2.0 TDI 4motion 2003>2015, TRANSPORTER V Bus 2.0 TSI 2003>2015, TRANSPORTER V Bus 2.0 TSI 4motion 2003>2015, TRANSPORTER V Bus 2.5 TDI 2003>2015, TRANSPORTER V Bus 2.5 TDI 4motion 2003>2015, TRANSPORTER V Bus 3.2 V6 2003>2015, TRANSPORTER V Bus 3.2 V6 4motion 2003>2015, TRANSPORTER V Platparam/Chassis 1.9 TDI 2003>2015, TRANSPORTER V Platparam/Chassis 2.0 2003>2015, TRANSPORTER V Platparam/Chassis 2.0 BiTDI 2003>2015, TRANSPORTER V Platparam/Chassis 2.0 BiTDI 4motion 2003>2015, TRANSPORTER V Platparam/Chassis 2.0 CNG 2003>2015, TRANSPORTER V Platparam/Chassis 2.0 TDI 2003>2015, TRANSPORTER V Platparam/Chassis 2.0 TDI 4motion 2003>2015, TRANSPORTER V Platparam/Chassis 2.0 TDI 4motion 2003>2015, TRANSPORTER V Platparam/Chassis 2.5 TDI 2003>2015, TRANSPORTER V Platparam/Chassis 2.5 TDI 4motion 2003>2015, TRANSPORTER V Platparam/Chassis 3.2 4motion 2003>2015, TRANSPORTER V Platparam/Chassis 3.2 V6 2003>2015, TRANSPORTER VI Box 2.0 TDI 2015>2016, TRANSPORTER VI Box 2.0 TDI 4motion 2015>2016, TRANSPORTER VI Box 2.0 TSI 2015>2016, TRANSPORTER VI Box 2.0 TSI 4motion 2015>2016, TRANSPORTER VI Bus 2.0 TDI 2015>1900, TRANSPORTER VI Bus 2.0 TDI 4motion 2015>1900, TRANSPORTER VI Bus 2.0 TSI 2015>1900, TRANSPORTER VI Bus 2.0 TSI 4motion 2015>1900, TRANSPORTER VI Platparam/Chassis 2.0 TDI 2015>2016, TRANSPORTER VI Platparam/Chassis 2.0 TDI 4motion 2015>2016, TRANSPORTER VI Platparam/Chassis 2.0 TSI 2015>2016, XL1 0.8 TDI E-Hybrid 2014>1900, AMAROK 2.0 TSI 4motion 2010>2016, BEETLE 1.8 TSI 2011>2019, BEETLE 2.5 2011>2019, BEETLE Convertible 1.8 TSI 2011>2019, BEETLE Convertible 2.5 2011>2019, CADDY III Estate 1.9 D 2004>2015, CC 3.6 FSI 2011>2016, GOLF ALLTRACK VII 1.8 TSI 4motion 2014>2018, GOLF IV 3.2 R32 4motion 1997>2007, GOLF V 1.8 T 2003>2009, GOLF V 2.5 2003>2009, GOLF VAN VII Variant 2.0 TDI BlueMotion 2013>2017, GOLF VI 2.0 2008>2013, GOLF VI 2.0 TFSI 4motion 2008>2013, GOLF VI 2.5 2008>2013, GOLF VI Blue E-Motion 2008>2013, GOLF VII 2.0 R 360S 4motion 2012>1900, GOLF VII Variant 1.8 TSI 4motion 2013>2018, GOLF VII Variant 2.0 R 360S 4motion 2013>2018, GOLF VII Variant 2.0 TDI 2013>2018, JETTA III 2.0 2004>2010, JETTA III 2.8 VR6 2004>2010, JETTA IV 1.8 TSI 2010>2018, JETTA IV 2.5 2010>2018, PASSAT 2.0 2005>2010, PASSAT 3.6 FSI 2005>2010, PASSAT 3.6 FSI 4motion 2005>2010, PASSAT Variant 2.0 2005>2011, PASSAT Variant 3.6 FSI 4motion 2005>2011, PASSAT Variant 3.6 FSI 4motion 2005>2011, SHARAN 1.8 TSI 2010>1900, TRANSPORTER IV Box 2.5 TDI Syncro 1995>2003, TRANSPORTER IV Bus 2.5 TDI Syncro 1996>2003, TRANSPORTER IV Platparam/Chassis 2.5 TDI Syncro 1998>2003, TRANSPORTER V Box 3.2 V6 4motion 2003>2015, TRANSPORTER V Bus 2.5 2003>2015;

PORSCHE: CARRERA GT 5.7 2003>2006;**CONTINUE...**

GS2021 // NEW //

FRONT AND REAR WHEEL SENSOR (RIGHT SIDE)

REPLACES / REEMPLAZA:

VW: 7H0927804, WHT003856, WHT003856A, 0986594505, 7L0927808A, 7L0927808B, 0986594525; **Bosch:** 0 986 594 505; **Delphi:** SS20036; **Meat & Doria:** 90061, 90061E; **Mobiletron:** AB-EU050

APPLICATION / APLICACIÓN:

...**SKODA:** OCTAVIA II 1.2 TSI 2004>2013, OCTAVIA II 1.4 2004>2013, OCTAVIA II 1.4 TSI 2004>2013, OCTAVIA II 1.6 2004>2013, OCTAVIA II 1.6 FSI 2004>2013, OCTAVIA II 1.6 LPG 2004>2013, OCTAVIA II 1.6 MultiFuel 2004>2013, OCTAVIA II 1.6 TDI 2004>2013, OCTAVIA II 1.8 TSI 2004>2013, OCTAVIA II 1.9 TDI 2004>2013, OCTAVIA II 2.0 FSI 2004>2013, OCTAVIA II 2.0 RS 2004>2013, OCTAVIA II 2.0 TDI 2004>2013, OCTAVIA II 2.0 TDI 16V 2004>2013, OCTAVIA II 2.0 TDI RS 2004>2013, OCTAVIA II Combi 1.2 TSI 2004>2013, OCTAVIA II Combi 1.4 2004>2013, OCTAVIA II Combi 1.4 TSI 2004>2013, OCTAVIA II Combi 1.6 2004>2013, OCTAVIA II Combi 1.6 FSI 2004>2013, OCTAVIA II Combi 1.6 LPG 2004>2013, OCTAVIA II Combi 1.6 MultiFuel 2004>2013, OCTAVIA II Combi 1.6 TDI 2004>2013, OCTAVIA II Combi 1.6 TDI 4x4 2004>2013, OCTAVIA II Combi 1.8 TSI 2004>2013, OCTAVIA II Combi 1.8 TSI 4x4 2004>2013, OCTAVIA II Combi 1.9 TDI 2004>2013, OCTAVIA II Combi 1.9 TDI 4x4 2004>2013, OCTAVIA II Combi 2.0 FSI 2004>2013, OCTAVIA II Combi 2.0 FSI 4x4 2004>2013, OCTAVIA II Combi 2.0 RS 2004>2013, OCTAVIA II Combi 2.0 TDI 2004>2013, OCTAVIA II Combi 2.0 TDI 16V 2004>2013, OCTAVIA II Combi 2.0 TDI 16V 4x4 2004>2013, OCTAVIA II Combi 2.0 TDI 4x4 2004>2013, OCTAVIA II Combi 2.0 TDI RS 2004>2013, OCTAVIA III 1.6 TDI 4x4 2014>1900, OCTAVIA III 1.8 TSI 4x4 2014>1900, OCTAVIA III 2.0 TDI / TDI RS 4x4 2014>1900, OCTAVIA III 2.0 TDI 4x4 2014>1900, OCTAVIA III Combi 1.6 TDI 4x4 2012>1900, OCTAVIA III Combi 1.8 TSI 4x4 2012>1900, OCTAVIA III Combi 2.0 TDI / TDI RS 4x4 2012>1900, OCTAVIA III Combi 2.0 TDI 4x4 2012>1900, SUPERB II 1.4 TSI 2008>2015, SUPERB II 1.6 TDI 2008>2015, SUPERB II 1.8 TSI 2008>2015, SUPERB II 1.8 TSI 4x4 2008>2015, SUPERB II 1.9 TDI 2008>2015, SUPERB II 2.0 TDI 2008>2015, SUPERB II 2.0 TDI 16V 2008>2015, SUPERB II 2.0 TDI 16V 4x4 2008>2015, SUPERB II 2.0 TDI 4x4 2008>2015, SUPERB II 2.0 TSI 2008>2015, SUPERB II 3.6 FSI 4x4 2008>2015, SUPERB II Estate 1.4 TSI 2009>2015, SUPERB II Estate 1.6 TDI 2009>2015, SUPERB II Estate 1.8 TSI 2009>2015, SUPERB II Estate 1.8 TSI 4x4 2009>2015, SUPERB II Estate 1.9 TDI 2009>2015, SUPERB II Estate 2.0 TDI 2009>2015, SUPERB II Estate 2.0 TDI 16V 4x4 2009>2015, SUPERB II Estate 2.0 TSI 2009>2015, SUPERB II Estate 3.6 V6 4x4 2009>2015, SUPERB III 1.4 TSI 4x4 2015>1900, SUPERB III 2.0 TDI 4x4 2015>1900, SUPERB III 2.0 TSI 4x4 2015>1900, SUPERB III Estate 1.4 TSI 4x4 2015>1900, SUPERB III Estate 2.0 TDI 4x4 2015>1900, SUPERB III Estate 2.0 TSI 4x4 2015>1900, YETI 1.2 TSI 2009>2017, YETI 1.4 TSI 2009>2017, YETI 1.4 TSI 4x4 2009>2017, YETI 1.6 TDI 2009>2017, YETI 1.8 TSI 4x4 2009>2017, YETI 2.0 TDI 2009>2017, YETI 2.0 TDI 4x4 2009>2017, OCTAVIA III 2.0 TSI 4x4 2014>1900, OCTAVIA III Combi 2.0 TSI 4x4 2012>1900;

MAN: TGE Box 2.0 TDI 2017>1900, TGE Box 2.0 TDI AWD 2017>1900, TGE Box 2.0 TDI RWD 2017>1900, TGE Box eTGE 2017>1900, TGE Platparam/Chassis 2.0 TDI 2016>1900, TGE Platparam/Chassis 2.0 TDI AWD 2016>1900, TGE Platparam/Chassis 2.0 TDI RWD 2016>1900



GS2022 // NEW //

FRONT AND REAR WHEEL SENSOR (LEFT SIDE)

REPLACES / REEMPLAZA:

VW: 7H0927803, WHT003857, 0986594504, 7L0927807A, 7L0927807B, 0986594524; **Bosch:** 0 986 594 504; **Delphi:** SS20035; **Meat & Doria:** 90060; **Mobiletron:** AB-EU051

APPLICATION / APLICACIÓN:

Audi: A1 1.0 TFSI 2010>2018, A1 1.4 TDI 2010>2018, A1 1.4 TFSI 2010>2018, A1 1.4 TSI 2010>2018, A1 1.6 TDI 2010>2018, A1 1.8 TFSI 2010>2018, A1 S1 quattro 2010>2018, A1 Sportback 1.0 TFSI 2011>2018, A1 Sportback 1.4 TDI 2011>2018, A1 Sportback 1.4 TFSI 2011>2018, A1 Sportback 1.4 TSI 2011>2018, A1 Sportback 1.6 TDI 2011>2018, A1 Sportback 1.8 TFSI 2011>2018, A1 Sportback S1 quattro 2011>2018, A3 1.2 TSI 2003>2012, A3 1.4 TFSI 2003>2012, A3 1.6 2003>2012, A3 1.6 E-Power 2003>2012, A3 1.6 FSI 2003>2012, A3 1.6 TDI 2003>2012, A3 1.8 TFSI 2003>2012, A3 1.8 TFSI quattro 2003>2012, A3 1.9 TDI 2003>2012, A3 2.0 FSI 2003>2012, A3 2.0 TDI 2003>2012, A3 2.0 TDI 16V 2003>2012, A3 2.0 TDI 16V quattro 2003>2012, A3 2.0 TDI quattro 2003>2012, A3 2.0 TFSI 2003>2012, A3 2.0 TFSI quattro 2003>2012, A3 3.2 V6 quattro 2003>2012, A3 S3 quattro 2003>2012, A3 1.8 TFSI quattro 2012>1900, A3 2.0 TDI quattro 2012>1900, A3 2.0 TFSI quattro 2012>1900, A3 S3 quattro 2012>1900, A3 Convertible 1.2 TFSI 2008>2013, A3 Convertible 1.4 TFSI 2008>2013, A3 Convertible 1.6 2008>2013, A3 Convertible 1.6 TDI 2008>2013, A3 Convertible 1.8 TFSI 2008>2013, A3 Convertible 1.9 TDI 2008>2013, A3 Convertible 2.0 TDI 2008>2013, A3 Convertible 2.0 TFSI 2008>2013, A3 Convertible 1.8 TFSI quattro 2014>1900, A3 Convertible 2.0 TDI quattro 2014>1900, A3 Convertible 2.0 TFSI quattro 2014>1900, A3 Convertible 40 TFSI 2014>1900, A3 Convertible S3 quattro 2014>1900, A3 Limousine 1.6 TDI quattro 2013>2019, A3 Limousine 1.8 TFSI quattro 2013>2019, A3 Limousine 2.0 TDI quattro 2013>2019, A3 Limousine 2.0 TFSI quattro 2013>2019, A3 Limousine S3 quattro 2013>2019, A3 Sportback 1.2 TSI 2004>2013, A3 Sportback 1.4 TFSI 2004>2013, A3 Sportback 1.6 2004>2013, A3 Sportback 1.6 E-Power 2004>2013, A3 Sportback 1.6 FSI 2004>2013, A3 Sportback 1.6 TDI 2004>2013, A3 Sportback 1.8 TFSI 2004>2013, A3 Sportback 1.8 TFSI quattro 2004>2013, A3 Sportback 1.9 TDI 2004>2013, A3 Sportback 2.0 FSI 2004>2013, A3 Sportback 2.0 TDI 2004>2013, A3 Sportback 2.0 TDI 16V 2004>2013, A3 Sportback 2.0 TDI 16V quattro 2004>2013, A3 Sportback 2.0 TDI quattro 2004>2013, A3 Sportback 2.0 TFSI 2004>2013, A3 Sportback 2.0 TFSI quattro 2004>2013, A3 Sportback 3.2 V6 quattro 2004>2013, A3 Sportback RS3 quattro 2004>2013, A3 Sportback S3 quattro 2004>2013, A3 Sportback 1.6 TDI quattro 2012>2018, A3 Sportback 1.8 TFSI quattro 2012>2018, A3 Sportback 2.0 TDI quattro 2012>2018, A3 Sportback 2.0 TFSI quattro 2012>2018, A3 Sportback S3 quattro 2012>2018, Q3 1.4 TFSI 2011>2018, Q3 1.4 TSI 2011>2018, Q3 2.0 TDI 2011>2018, Q3 2.0 TDI quattro 2011>2018, Q3 2.0 TFSI 2011>2018, Q3 2.0 TFSI quattro 2011>2018, Q3 RS 2.5 quattro 2011>2018, Q3 RS perparamance 2.5 quattro 2011>2018, TT 1.8 TFSI 2006>2014, TT 2.0 TDI quattro 2006>2014, TT 2.0 TFSI 2006>2014, TT 2.0 TFSI quattro 2006>2014, TT 2.0 TFSI quattro 2006>2014, TT 2.5 RS quattro 2006>2014, TT 3.2 V6 quattro 2006>2014, TT Roadster 1.8 TFSI 2007>2014, TT Roadster 2.0 TDI quattro 2007>2014, TT Roadster 2.0 TFSI 2007>2014, TT Roadster 2.0 TFSI quattro 2007>2014, TT Roadster 2.0 TFSI quattro 2007>2014, TT Roadster 2.5 RS quattro 2007>2014, TT Roadster 3.2 V6 quattro 2007>2014, A1 1.2 TFSI 2010>2018, A1 2.0 TDI 2010>2018, A1 2.0 TFSI quattro 2010>2018, A1 Sportback 1.2 TFSI 2011>2018, A1 Sportback 2.0 TDI 2011>2018, A3 1.8 T 2003>2012, A3 Convertible 40 TFSI quattro 2014>1900, A3 Limousine 40 TDI quattro 2013>2019, A3 Limousine 40 TFSI quattro 2013>2019, A3 Limousine RS3 quattro 2013>2019, A3 Sportback 40 TDI quattro 2012>2018, A3 Sportback 40 TFSI quattro 2012>2018, A3 Sportback RS3 quattro 2012>2018, Q3 1.4 TFSI Flex 2011>2018, TT 2.0 TFSI 2014>1900, TT 2.0 TFSI quattro 2014>1900, TT 2.0 TFSI quattro 2014>1900, TT Roadster 2.0 TFSI 2014>1900, TT Roadster 2.0 TFSI quattro 2014>1900, TT Roadster 2.0 TFSI quattro 2014>1900, SEAT: ALHAMBRA 1.4 TSI 2010>2011, ALHAMBRA 1.8 TSI 2010>2011, ALHAMBRA 2.0 TDI 2010>2011, ALHAMBRA 3.0 TDI 4Drive 2010>2011, ALHAMBRA 2.0 TSI 2010>2011, ALTEA 1.2 TSI 2004>2011, ALTEA 1.4 16V 2004>2011, ALTEA 1.4 TSI 2004>2011, ALTEA 1.6 2004>2011, ALTEA 1.6 LPG 2004>2011, ALTEA 1.6 MultiFuel 2004>2011, ALTEA 1.6 TDI 2004>2011, ALTEA 1.8 TFSI 2004>2011, ALTEA 1.9 TDI 2004>2011, ALTEA 2.0 FSI 2004>2011, ALTEA 2.0 TDI 2004>2011, ALTEA 2.0 TDI 16V 2004>2011, ALTEA 2.0 TFSI 2004>2011, ALTEA XL 1.2 TSI 2006>2010, ALTEA XL 1.4 16V 2006>2010, ALTEA XL 1.4 TSI 2006>2010, ALTEA XL 1.6 2006>2010, ALTEA XL 1.6 LPG 2006>2010, ALTEA XL 1.6 MultiFuel 2006>2010, ALTEA XL 1.6 TDI 2006>2010, ALTEA XL 1.8 TFSI 2006>2010, ALTEA XL 1.9 TDI 2006>2010, ALTEA XL 1.9 TDI 4x4 2006>2010, ALTEA XL 2.0 FSI 2006>2010, ALTEA XL 2.0 TDI 2006>2010, ALTEA XL 2.0 TDI 16V 2006>2010, ALTEA XL 2.0 TDI 16V 4x4 2006>2010, ALTEA XL 2.0 TDI 4x4 2006>2010, ALTEA XL 2.0 TFSI 2006>2010, ALTEA XL 2.0 TFSI 4x4 2006>2010, LEON 1.2 TSI 2005>2012, LEON 1.4 16V 2005>2012, LEON 1.4 TSI 2005>2012, LEON 1.6 2005>2012, LEON 1.6 LPG 2005>2012, LEON 1.6 MultiFuel 2005>2012, LEON 1.6 TDI 2005>2012, LEON 1.8 TSI 2005>2012, LEON 1.9 TDI 2005>2012, LEON 2.0 Cupra R 2005>2012, LEON 2.0 FSI 2005>2012, LEON 2.0 TDI 2005>2012, LEON 2.0 TDI 16V 2005>2012, LEON 2.0 TFSI 2005>2012, LEON ST 1.6 TDI 4Drive 2014>1900, LEON ST 1.8 TSI 4Drive 2014>1900, LEON ST 2.0 TDI 4Drive 2014>1900, LEON ST Box Body/Estate 2.0 TDI 4Drive 2014>1900, TOLEDO III 1.4 16V 2004>2009, TOLEDO III 1.4 TSI 2004>2009, TOLEDO III 1.6 2004>2009, TOLEDO III 1.8 TFSI 2004>2009, TOLEDO III 1.9 TDI 2004>2009, TOLEDO III 2.0 FSI 2004>2009, TOLEDO III 2.0 TDI 2004>2009, TOLEDO III 2.0 TDI 16V 2004>2009, TOLEDO III 2.0 TFSI 2004>2009, ALTEA 2.0 TDI 16V 4WD 2004>2011, LEON ST 2.0 Cupra 4Drive 2014>1900, LEON ST 2.0 TSI 4Drive 2014>1900, **VW:** AMAROK 2.0 BITDI 2010>2016, AMAROK 2.0 BITDI 4motion 2010>2016, AMAROK 2.0 TDI 2010>2016, AMAROK 2.0 TDI 4motion 2010>2016, AMAROK 2.0 TSI 2010>2016, AMAROK 3.0 TDI 2010>2016, AMAROK 3.0 TDI 4motion 2010>2016, AMAROK Platparam/Chassis 2.0 TDI 2011>2016, AMAROK Platparam/Chassis 2.0 TDI 4motion 2011>2016, AMAROK Platparam/Chassis 2.0 TSI 2011>2016, AMAROK Platparam/Chassis 3.0 TDI 4motion 2011>2016, BEETLE 1.2 TSI 2011>2019, BEETLE 1.2 TSI 16V 2011>2019, BEETLE 1.4 TSI 2011>2019, BEETLE 1.6 TDI 2011>2019, BEETLE 2.0 TDI 2011>2019, BEETLE 2.0 TSI 2011>2019, BEETLE Convertible 1.2 TSI 2011>2019, BEETLE Convertible 1.4 TSI 2011>2019, BEETLE Convertible 1.6 TDI 2011>2019, BEETLE Convertible 2.0 TDI 2011>2019, BEETLE Convertible 2.0 TSI 2011>2019, BEETLE Convertible 2.0 TSI 2011>2019, CADDY ALLTRACK Box 1.0 TSI 2015>2017, CADDY ALLTRACK Box 1.2 TSI 2015>2017, CADDY ALLTRACK Box 1.4 TGI CNG 2015>2017, CADDY ALLTRACK Box 1.4 TSI 2015>2017, CADDY ALLTRACK Box 1.6 TDI 2015>2017, CADDY ALLTRACK Box 2.0 TDI 4motion 2015>2017, CADDY ALLTRACK Estate 1.0 TSI 2015>2017, CADDY ALLTRACK Estate 1.2 TSI 2015>2017, CADDY ALLTRACK Estate 1.4 TGI CNG 2015>2017...

CONTINUE...

GS2022 // NEW //
FRONT AND REAR WHEEL SENSOR (LEFT SIDE)

REPLACES / REEMPLAZA:
VW: 7H0927803, WHT003857, 0986594504, 7L0927807A, 7L0927807B, 0986594524; **Bosch:** 0 986 594 504; **Delphi:** SS20035; **Meat & Doria:** 90060;

Mobiletron: AB-EU051

APPLICATION / APLICACIÓN:

...**VW:** CADDY ALLTRACK Estate 1.4 TSI 2015>2017, CADDY ALLTRACK Estate 1.6 TDI 2015>2017, CADDY ALLTRACK Estate 2.0 TDI 2015>2017, CADDY III Box 1.2 TSI 2004>2015, CADDY III Box 1.4 2004>2015, CADDY III Box 1.6 2004>2015, CADDY III Box 1.6 BiFuel 2004>2015, CADDY III Box 1.6 TDI 2004>2015, CADDY III Box 1.9 TDI 2004>2015, CADDY III Box 1.9 TDI 4motion 2004>2015, CADDY III Box 2.0 EcoFuel 2004>2015, CADDY III Box 2.0 SDI 2004>2015, CADDY III Box 2.0 TDI 2004>2015, CADDY III Box 2.0 TDI 16V 2004>2015, CADDY III Box 2.0 TDI 16V 4motion 2004>2015, CADDY III Box 2.0 TDI 4motion 2004>2015, CADDY III Estate 1.2 TSI 2004>2015, CADDY III Estate 1.4 2004>2015, CADDY III Estate 1.6 2004>2015, CADDY III Estate 1.6 BiFuel 2004>2015, CADDY III Estate 1.6 TDI 2004>2015, CADDY III Estate 1.9 TDI 2004>2015, CADDY III Estate 1.9 TDI 4motion 2004>2015, CADDY III Estate 2.0 EcoFuel 2004>2015, CADDY III Estate 2.0 SDI 2004>2015, CADDY III Estate 2.0 TDI 2004>2015, CADDY III Estate 2.0 TDI 16V 2004>2015, CADDY III Estate 2.0 TDI 16V 4motion 2004>2015, CADDY III Estate 2.0 TDI 4motion 2004>2015, CADDY IV Box 1.0 TSI 2015>2017, CADDY IV Box 1.2 TSI 2015>2017, CADDY IV Box 1.4 TGI CNG 2015>2017, CADDY IV Box 1.4 TGI CNG 2015>2017, CADDY IV Box 1.4 TSI 2015>2017, CADDY IV Box 1.6 2015>2017, CADDY IV Box 1.6 TDI 2015>2017, CADDY IV Box 2.0 TDI 2015>2017, CADDY IV Box 2.0 TDI 4motion 2015>2017, CC 1.4 TSI 2011>2016, CC 1.4 TSI MultiFuel 2011>2016, CC 1.8 TSI 2011>2016, CC 2.0 TDI 2011>2016, CC 2.0 TDI 4motion 2011>2016, CC 2.0 TSI 2011>2016, CC 3.6 FSI 4motion 2011>2016, CRAFTER Box 2.0 TDI 2016>1900, CRAFTER Box 2.0 TDI 4motion 2016>1900, CRAFTER Box 2.0 TDI RWD 2016>1900, CRAFTER Box e-Crafter 2016>1900, CRAFTER Bus 2.0 TDI 2016>1900, CRAFTER Bus 2.0 TDI 4motion 2016>1900, CRAFTER Platparam/Chassis 2.0 TDI 2016>1900, CRAFTER Platparam/Chassis 2.0 TDI 4motion 2016>1900, EOS 1.4 TSI 2006>2015, EOS 1.6 FSI 2006>2015, EOS 2.0 FSI 2006>2015, EOS 2.0 TDI 2006>2015, EOS 2.0 TDI 16V 2006>2015, EOS 2.0 TFSI 2006>2015, EOS 2.0 TSI 2006>2015, EOS 3.2 V6 2006>2015, EOS 3.6 V6 2006>2015, GOLF ALLTRACK VII 1.6 TDI 4motion 2014>2018, GOLF ALLTRACK VII 2.0 TDI 4motion 2014>2018, GOLF PLUS 1.2 TSI 2004>2013, GOLF PLUS 1.4 16V 2004>2013, GOLF PLUS 1.4 FSI 2004>2013, GOLF PLUS 1.4 TSI 2004>2013, GOLF PLUS 1.6 2004>2013, GOLF PLUS 1.6 BiFuel 2004>2013, GOLF PLUS 1.6 FSI 2004>2013, GOLF PLUS 1.6 MultiFuel 2004>2013, GOLF PLUS 1.6 TDI 2004>2013, GOLF PLUS 1.9 TDI 2004>2013, GOLF PLUS 2.0 FSI 2004>2013, GOLF PLUS 2.0 TDI 2004>2013, GOLF PLUS 2.0 TDI 16V 2004>2013, GOLF PLUS Van 1.2 TSI 2009>2014, GOLF PLUS Van 1.4 TSI 2009>2014, GOLF PLUS Van 1.6 TDI 2009>2014, GOLF PLUS Van 2.0 TDI 2009>2014, GOLF V 1.4 16V 2003>2009, GOLF V 1.4 FSI 2003>2009, GOLF V 1.4 TSI 2003>2009, GOLF V 1.6 2003>2009, GOLF V 1.6 FSI 2003>2009, GOLF V 1.6 MultiFuel 2003>2009, GOLF V 1.9 TDI 2003>2009, GOLF V 1.9 TDI 4motion 2003>2009, GOLF V 2.0 2003>2009, GOLF V 2.0 FSI 2003>2009, GOLF V 2.0 FSI 4motion 2003>2009, GOLF V 2.0 GTI 2003>2009, GOLF V 2.0 SDI 2003>2009, GOLF V 2.0 TDI 2003>2009, GOLF V 2.0 TDI 16V 2003>2009, GOLF V 2.0 TDI 16V 4motion 2003>2009, GOLF V 2.0 TDI 4motion 2003>2009, GOLF V 3.2 R32 4motion 2003>2009, GOLF V Variant 1.4 2007>2009, GOLF V Variant 1.4 TSI 2007>2009, GOLF V Variant 1.6 2007>2009, GOLF V Variant 1.6 MultiFuel 2007>2009, GOLF V Variant 1.9 TDI 2007>2009, GOLF V Variant 1.9 TDI 4motion 2007>2009, GOLF V Variant 1.9 TDI 4motion 2007>2009, GOLF V Variant 2.0 TDI 2007>2009, GOLF V Variant 2.0 TDI 16V 2007>2009, GOLF V Variant 2.5 2007>2009, GOLF VAN VI Variant 1.2 TSI 2009>2014, GOLF VAN VI Variant 1.4 TSI 2009>2014, GOLF VAN VI Variant 1.6 TDI 2009>2014, GOLF VAN VI Variant 1.6 TDI BlueMotion 2009>2014, GOLF VAN VI Variant 2.0 TDI 2009>2014, GOLF VAN VII Variant 1.6 TDI BlueMotion 4motion 2013>2017, GOLF VAN VII Variant 2.0 TDI BlueMotion 4motion 2013>2017, GOLF VI 1.2 TSI 2008>2013, GOLF VI 1.4 2008>2013, GOLF VI 1.4 TSI 2008>2013, GOLF VI 1.6 2008>2013, GOLF VI 1.6 BiFuel 2008>2013, GOLF VI 1.6 MultiFuel 2008>2013, GOLF VI 1.6 TDI 2008>2013, GOLF VI 1.8 TSI 2008>2013, GOLF VI 2.0 GTI 2008>2013, GOLF VI 2.0 R 4motion 2008>2013, GOLF VI 2.0 TDI 2008>2013, GOLF VI 2.0 TDI 4motion 2008>2013, GOLF VI Convertible 1.2 TSI 2011>2016, GOLF VI Convertible 1.2 TSI 16V 2011>2016, GOLF VI Convertible 1.4 TSI 2011>2016, GOLF VI Convertible 1.6 TDI 2011>2016, GOLF VI Convertible 2.0 GTI 2011>2016, GOLF VI Convertible 2.0 R 2011>2016, GOLF VI Convertible 2.0 TDI 2011>2016, GOLF VI Convertible 2.0 TSI 2011>2016, GOLF VI Van 1.2 TSI 2008>2012, GOLF VI Van 1.2 TSI BlueMotion 2008>2012, GOLF VI Van 1.4 TSI 2008>2012, GOLF VI Van 1.6 TDI 2008>2012, GOLF VI Van 1.6 TDI BlueMotion 2008>2012, GOLF VI Van 2.0 GTI 2008>2012, GOLF VI Van 2.0 TDI 2008>2012, GOLF VI Van 2.0 TSI R 4motion 2008>2012, GOLF VI Van TSI 2008>2012, GOLF VI Variant 1.2 TSI 2009>2014, GOLF VI Variant 1.4 2009>2014, GOLF VI Variant 1.4 TSI 2009>2014, GOLF VI Variant 1.6 2009>2014, GOLF VI Variant 1.6 BiFuel 2009>2014, GOLF VI Variant 1.6 MultiFuel 2009>2014, GOLF VI Variant 1.6 TDI 2009>2014, GOLF VI Variant 1.6 TDI 4motion 2009>2014, GOLF VI Variant 2.0 TDI 2009>2014, GOLF VI Variant 2.0 TSI 2009>2014, GOLF VII Variant 2.5 2009>2014, GOLF VII 1.6 TDI 4motion 2012>1900, GOLF VII 2.0 GTI 2012>1900, GOLF VII 2.0 R 4motion 2012>1900, GOLF VII 2.0 TDI 2012>1900, GOLF VII 2.0 TDI 4motion 2012>1900, GOLF VII Van 2.0 GTI 2013>1900, GOLF VII Van 2.0 TDI BlueMotion 4motion 2013>1900, GOLF VII Variant 1.6 TDI 4motion 2013>2018, GOLF VII Variant 2.0 R 4motion 2013>2018, GOLF VII Variant 2.0 TDI 4motion 2013>2018, GRAND CALIPARANIA Camper 2.0 TDI 2019>1900, GRAND CALIPARANIA Camper 2.0 TDI 4motion 2019>1900, JETTA III 1.4 TSI 2004>2010, JETTA III 1.6 2004>2010, JETTA III 1.6 FSI 2004>2010, JETTA III 1.6 MultiFuel 2004>2010, JETTA III 1.6 TDI 2004>2010, JETTA III 1.9 TDI 2004>2010, JETTA III 2.0 FSI 2004>2010, JETTA III 2.0 TDI 2004>2010, JETTA III 2.0 TDI 16V 2004>2010, JETTA III 2.0 TFSI 2004>2010, JETTA III 2.5 2004>2010, JETTA IV 1.2 TSI 2010>2018, JETTA IV 1.2 TSI 16V 2010>2018, JETTA IV 1.4 TSI 2010>2018, JETTA IV 1.4 TSI Hybrid 2010>2018, JETTA IV 1.6 2010>2018, JETTA IV 1.6 MPI 2010>2018, JETTA IV 1.6 TDI 2010>2018, JETTA IV 2.0 2010>2018, JETTA IV 2.0 Flex 2010>2018, JETTA IV 2.0 TDI 2010>2018, JETTA IV 2.0 TSI 2010>2018, JETTA Saloon 1.4 TSI 2017>1900, MULTIVAN V 1.9 TDI 2003>2015, MULTIVAN V 2.0 2003>2015, MULTIVAN V 2.0 BiTDI 2003>2015, MULTIVAN V 2.0 BiTDI 4motion 2003>2015, MULTIVAN V 2.0 TDI 2003>2015, MULTIVAN V 2.0 TDI 4motion 2003>2015, MULTIVAN V 2.0 TSI 2003>2015, MULTIVAN V 2.0 TSI 4motion 2003>2015, MULTIVAN V 2.5 TDI 2003>2015, MULTIVAN V 2.5 TDI 4motion 2003>2015, MULTIVAN V 3.2 V6 2003>2015, MULTIVAN V 3.2 V6 4motion 2003>2015, MULTIVAN VI 2.0 TDI 2015>1900, MULTIVAN VI 2.0 TDI 4motion 2015>1900, MULTIVAN VI 2.0 TSI 2015>1900, MULTIVAN VI 2.0 TSI 4motion 2015>1900, PASSAT 1.4 TSI 2010>2014, PASSAT 1.4 TSI EcoFuel 2010>2014, PASSAT 1.4 TSI MultiFuel 2010>2014, PASSAT 1.6 TDI 2010>2014, PASSAT 1.8 TSI 2010>2014, PASSAT 2.0 TDI 2010>2014, PASSAT 2.0 TDI 4motion 2010>2014, PASSAT 2.0 TSI 2010>2014, PASSAT 3.6 FSI 4motion 2010>2014, PASSAT 1.4 TSI 2005>2010, PASSAT 1.4 TSI EcoFuel 2005>2010, PASSAT 1.6 2005>2010, PASSAT 1.6 FSI 2005>2010, PASSAT 1.6 TDI 2005>2010, PASSAT 1.8 TSI 2005>2010, PASSAT 1.9 TDI 2005>2010, PASSAT 2.0 BlueTDI 2005>2010, PASSAT 2.0 FSI 2005>2010, PASSAT 2.0 FSI 4motion 2005>2010, PASSAT 2.0 TDI 2005>2010, PASSAT 2.0 TDI 16V 2005>2010, PASSAT 2.0 TDI 16V 4motion 2005>2010, PASSAT 2.0 TDI 4motion 2005>2010, PASSAT 3.2 FSI 4motion 2005>2010, PASSAT 3.6 R36 4motion 2005>2010, PASSAT 2.5 2011>1900, PASSAT ALLTRACK 1.8 TSI 2012>2014, PASSAT ALLTRACK 2.0 TDI 2012>2014, PASSAT ALLTRACK 2.0 TDI 4motion 2012>2014, PASSAT ALLTRACK 2.0 TSI 4motion 2012>2014, PASSAT Box Body/Estate 1.4 TSI BlueMotion 2010>2014, PASSAT Box Body/Estate 1.6 TDI BlueMotion 2010>2014, PASSAT Box Body/Estate 2.0 TFSI 2010>2014, PASSAT Box Body/Estate 3.6 FSI 4motion 2010>2014, PASSAT CC 1.4 TSI MultiFuel 2008>2012, PASSAT CC 1.8 TSI 2008>2012, PASSAT CC 2.0 BlueTDI 2008>2012, PASSAT CC 2.0 TDI 2008>2012, PASSAT CC 2.0 TDI 4motion 2008>2012, PASSAT CC 2.0 TSI 2008>2012, PASSAT CC 3.6 FSI 2008>2012, PASSAT CC 3.6 FSI 4motion 2008>2012, PASSAT Variant 1.4 TSI 2010>2015, PASSAT Variant 1.4 TSI EcoFuel 2010>2015, PASSAT Variant 1.4 TSI MultiFuel 2010>2015, PASSAT Variant 1.6 TDI 2010>2015, PASSAT Variant 1.8 TSI 2010>2015, PASSAT Variant 2.0 TDI 2010>2015, PASSAT Variant 2.0 TDI 4motion 2010>2015, PASSAT Variant 2.0 TSI 2010>2015, PASSAT Variant 3.6 FSI 4motion 2010>2015, PASSAT Variant 1.4 TSI 2005>2011, PASSAT Variant 1.4 TSI EcoFuel 2005>2011, PASSAT Variant 1.6 2005>2011, PASSAT Variant 1.6 FSI 2005>2011, PASSAT Variant 1.6 TDI 2005>2011, PASSAT Variant 1.8 TSI 2005>2011, PASSAT Variant 1.8 TSI EcoFuel 2005>2011, PASSAT Variant 1.9 TDI 2005>2011, PASSAT Variant 2.0 BlueTDI 2005>2011, PASSAT Variant 2.0 FSI 2005>2011, PASSAT Variant 2.0 FSI 4motion 2005>2011, PASSAT Variant 2.0 TDI 2005>2011, PASSAT Variant 2.0 TDI 16V 2005>2011, PASSAT Variant 2.0 TDI 16V 4motion 2005>2011, PASSAT Variant 2.0 TDI 4motion 2005>2011, PASSAT Variant 3.2 FSI 4motion 2005>2011, PASSAT Variant 3.6 R36 4motion 2005>2011, SCIROCCO 1.4 TSI 2008>2017, SCIROCCO 2.0 R 2008>2017, SCIROCCO 2.0 TDI 2008>2017, SCIROCCO 2.0 TSI 2008>2017, SCIROCCO Van 1.4 TSI 2008>2014, SCIROCCO Van 2.0 TDI 2008>2014, SCIROCCO Van 2.0 TFSI 2008>2014, SHARAN 1.4 TSI 2010>1900, SHARAN 2.0 TDI 2010>1900, SHARAN 2.0 TDI 4motion 2010>1900, SHARAN 2.0 TSI 2010>1900, TIGUAN 1.4 TSI 2007>2018, TIGUAN 1.4 TSI 4motion 2007>2018, TIGUAN 2.0 TDI 2007>2018, TIGUAN 2.0 TDI 4motion 2007>2018, TIGUAN 2.0 TFSI 2007>2018, TIGUAN 2.0 TFSI 4motion 2007>2018, TIGUAN 2.0 TSI 4motion 2007>2018, TOURAN 1.4 FSI 2003>2010, TOURAN 1.4 TSI 2003>2010, TOURAN 1.4 TSI EcoFuel 2003>2010, TOURAN 1.6 2003>2010, TOURAN 1.6 BiFuel 2003>2010, TOURAN 1.6 FSI 2003>2010, TOURAN 1.9 TDI 2003>2010, TOURAN 2.0 EcoFuel 2003>2010, TOURAN 2.0 FSI 2003>2010, TOURAN 2.0 TDI 2003>2010, TOURAN 2.0 TDI 16V 2003>2010, TOURAN 1.2 TSI 2010>2015, TOURAN 1.4 TSI 2010>2015, TOURAN 1.4 TSI EcoFuel 2010>2015, TOURAN 1.6 TDI 2010>2015, TOURAN 2.0 TDI 2010>2015, TRANSPORTER V Box 1.9 TDI 2003>2015, TRANSPORTER V Box 2.0 2003>2015, TRANSPORTER V Box 2.0 BiFuel 2003>2015, TRANSPORTER V Box 2.0 BiTDI 2003>2015, TRANSPORTER V Box 2.0 BiTDI 4motion 2003>2015, TRANSPORTER V Box 2.0 TDI 2003>2015, TRANSPORTER V Box 2.0 TDI 4motion 2003>2015...

CONTINUE...

GS2022 // NEW //

FRONT AND REAR WHEEL SENSOR (LEFT SIDE)



REPLACES / REEMPLAZA:

VW: 7H0927803, WHT003857, 0986594504, 7L0927807A, 7L0927807B, 0986594524; **Bosch:** 0 986 594 504; **Delphi:** SS20035; **Meat & Doria:** 90060;

Mobiletron: AB-EU051

APPLICATION / APLICACIÓN:

... **VW:** TRANSPORTER V Box 2.0 TSI 2003>2015, TRANSPORTER V Box 2.0 TSI 4motion 2003>2015, TRANSPORTER V Box 2.5 TDI 2003>2015, TRANSPORTER V Box 2.5 TDI 4motion 2003>2015, TRANSPORTER V Box 3.2 4motion 2003>2015, TRANSPORTER V Box 3.2 V6 2003>2015, TRANSPORTER V Bus 1.9 TDI 2003>2015, TRANSPORTER V Bus 2.0 2003>2015, TRANSPORTER V Bus 2.0 BitDI 2003>2015, TRANSPORTER V Bus 2.0 BitDI 4motion 2003>2015, TRANSPORTER V Bus 2.0 CNG 2003>2015, TRANSPORTER V Bus 2.0 TDI 2003>2015, TRANSPORTER V Bus 2.0 TDI 4motion 2003>2015, TRANSPORTER V Bus 2.0 TSI 2003>2015, TRANSPORTER V Bus 2.0 TSI 4motion 2003>2015, TRANSPORTER V Bus 2.5 TDI 2003>2015, TRANSPORTER V Bus 2.5 TDI 4motion 2003>2015, TRANSPORTER V Bus 3.2 V6 2003>2015, TRANSPORTER V Bus 3.2 V6 4motion 2003>2015, TRANSPORTER V Platparam/Chassis 1.9 TDI 2003>2015, TRANSPORTER V Platparam/Chassis 2.0 2003>2015, TRANSPORTER V Platparam/Chassis 2.0 BitDI 2003>2015, TRANSPORTER V Platparam/Chassis 2.0 BitDI 4motion 2003>2015, TRANSPORTER V Platparam/Chassis 2.0 CNG 2003>2015, TRANSPORTER V Platparam/Chassis 2.0 TDI 2003>2015, TRANSPORTER V Platparam/Chassis 2.0 TDI 4motion 2003>2015, TRANSPORTER V Platparam/Chassis 2.0 TSI 2003>2015, TRANSPORTER V Platparam/Chassis 2.5 TDI 2003>2015, TRANSPORTER V Platparam/Chassis 2.5 TDI 4motion 2003>2015, TRANSPORTER V Platparam/Chassis 3.2 4motion 2003>2015, TRANSPORTER V Platparam/Chassis 3.2 V6 2003>2015, TRANSPORTER VI Box 2.0 TDI 2015>2016, TRANSPORTER VI Box 2.0 TDI 4motion 2015>2016, TRANSPORTER VI Box 2.0 TSI 2015>2016, TRANSPORTER VI Box 2.0 TSI 4motion 2015>2016, TRANSPORTER VI Bus 2.0 TDI 2015>1900, TRANSPORTER VI Bus 2.0 TDI 4motion 2015>1900, TRANSPORTER VI Bus 2.0 TSI 2015>1900, TRANSPORTER VI Bus 2.0 TSI 4motion 2015>1900, TRANSPORTER VI Platparam/Chassis 2.0 TDI 2015>2016, TRANSPORTER VI Platparam/Chassis 2.0 TDI 4motion 2015>2016, TRANSPORTER VI Platparam/Chassis 2.0 TSI 2015>2016, XL1 0.8 TDI E-Hybrid 2014>1900, AMAROK 2.0 TSI 4motion 2010>2016, BEETLE 1.8 TSI 2011>2019, BEETLE 2.5 2011>2019, BEETLE Convertible 1.8 TSI 2011>2019, BEETLE Convertible 2.5 2011>2019, CADDY III Estate 1.9 D 2004>2015, GOLF ALLTRACK VII 1.8 TSI 4motion 2014>2018, GOLF IV 3.2 R32 4motion 1997>2007, GOLF V 1.8 T 2003>2009, GOLF V 2.5 2003>2009, GOLF VAN VII Variant 2.0 TDI BlueMotion 2013>2017, GOLF VI 2.0 2008>2013, GOLF VI 2.0 TFSI 4motion 2008>2013, GOLF VI 2.5 2008>2013, GOLF VI Blue E-Motion 2008>2013, GOLF VII 2.0 R 360S 4motion 2012>1900, GOLF VII Variant 1.8 TSI 4motion 2013>2018, GOLF VII Variant 2.0 R 360S 4motion 2013>2018, GOLF VII Variant 2.0 TDI 2013>2018, JETTA III 2.0 2004>2010, JETTA III 2.8 VR6 2004>2010, JETTA IV 1.8 TSI 2010>2018, JETTA IV 2.5 2010>2018, PASSAT 2.0 2005>2010, PASSAT 3.6 FSI 2005>2010, PASSAT 3.6 FSI 4motion 2005>2010, PASSAT Variant 2.0 2005>2011, PASSAT Variant 3.6 FSI 2005>2011, PASSAT Variant 3.6 FSI 4motion 2005>2011, SHARAN 1.8 TSI 2010>1900, TRANSPORTER IV Box 2.5 TDI Syncro 1995>2003, TRANSPORTER IV Bus 2.5 TDI Syncro 1996>2003, TRANSPORTER IV Platparam/Chassis 2.5 TDI Syncro 1998>2003, TRANSPORTER V Box 3.2 V6 4motion 2003>2015, TRANSPORTER V Bus 2.5 2003>2015;

PORSCHE: CARRERA GT 5.7 2003>2006;

SKODA: OCTAVIA II 1.2 TSI 2004>2013, OCTAVIA II 1.4 2004>2013, OCTAVIA II 1.4 TSI 2004>2013, OCTAVIA II 1.6 2004>2013, OCTAVIA II 1.6 FSI 2004>2013, OCTAVIA II 1.6 LPG 2004>2013, OCTAVIA II 1.6 MultiFuel 2004>2013, OCTAVIA II 1.6 TDI 2004>2013, OCTAVIA II 1.8 TSI 2004>2013, OCTAVIA II 1.9 TDI 2004>2013, OCTAVIA II 2.0 FSI 2004>2013, OCTAVIA II 2.0 RS 2004>2013, OCTAVIA II 2.0 TDI 2004>2013, OCTAVIA II 2.0 TDI 16V 2004>2013, OCTAVIA II 2.0 TDI RS 2004>2013, OCTAVIA II Combi 1.2 TSI 2004>2013, OCTAVIA II Combi 1.4 2004>2013, OCTAVIA II Combi 1.4 TSI 2004>2013, OCTAVIA II Combi 1.6 2004>2013, OCTAVIA II Combi 1.6 FSI 2004>2013, OCTAVIA II Combi 1.6 LPG 2004>2013, OCTAVIA II Combi 1.6 MultiFuel 2004>2013, OCTAVIA II Combi 1.6 TDI 2004>2013, OCTAVIA II Combi 1.6 TDI 4x4 2004>2013, OCTAVIA II Combi 1.8 TSI 2004>2013, OCTAVIA II Combi 1.8 TSI 4x4 2004>2013, OCTAVIA II Combi 1.9 TDI 2004>2013, OCTAVIA II Combi 1.9 TDI 4x4 2004>2013, OCTAVIA II Combi 2.0 FSI 2004>2013, OCTAVIA II Combi 2.0 FSI 4x4 2004>2013, OCTAVIA II Combi 2.0 RS 2004>2013, OCTAVIA II Combi 2.0 TDI 2004>2013, OCTAVIA II Combi 2.0 TDI 16V 2004>2013, OCTAVIA II Combi 2.0 TDI 16V 4x4 2004>2013, OCTAVIA II Combi 2.0 TDI 4x4 2004>2013, OCTAVIA II Combi 2.0 TDI RS 2004>2013, OCTAVIA III 1.6 TDI 4x4 2014>1900, OCTAVIA III 1.8 TSI 4x4 2014>1900, OCTAVIA III 2.0 TDI / TDI RS 4x4 2014>1900, OCTAVIA III 2.0 TDI 4x4 2014>1900, OCTAVIA III Combi 1.6 TDI 4x4 2012>1900, OCTAVIA III Combi 1.8 TSI 4x4 2012>1900, OCTAVIA III Combi 2.0 TDI / TDI RS 4x4 2012>1900, OCTAVIA III Combi 2.0 TDI 4x4 2012>1900, SUPERB II 1.4 TSI 2008>2015, SUPERB II 1.6 TDI 2008>2015, SUPERB II 1.8 TSI 2008>2015, SUPERB II 1.8 TSI 4x4 2008>2015, SUPERB II 1.9 TDI 2008>2015, SUPERB II 2.0 TDI 2008>2015, SUPERB II 2.0 TDI 16V 2008>2015, SUPERB II 2.0 TDI 16V 4x4 2008>2015, SUPERB II 2.0 TDI 4x4 2008>2015, SUPERB II 2.0 TSI 2008>2015, SUPERB II 3.6 FSI 4x4 2008>2015, SUPERB II Estate 1.4 TSI 2009>2015, SUPERB II Estate 1.6 TDI 2009>2015, SUPERB II Estate 1.8 TSI 2009>2015, SUPERB II Estate 1.8 TSI 4x4 2009>2015, SUPERB II Estate 1.9 TDI 2009>2015, SUPERB II Estate 2.0 TDI 2009>2015, SUPERB II Estate 2.0 TDI 16V 2009>2015, SUPERB II Estate 2.0 TDI 16V 4x4 2009>2015, SUPERB II Estate 2.0 TDI 4x4 2009>2015, SUPERB II Estate 2.0 TSI 2009>2015, SUPERB II Estate 3.6 V6 4x4 2009>2015, SUPERB III 1.4 TSI 4x4 2015>1900, SUPERB III 2.0 TDI 4x4 2015>1900, SUPERB III 2.0 TSI 4x4 2015>1900, SUPERB III Estate 1.4 TSI 4x4 2015>1900, SUPERB III Estate 2.0 TDI 4x4 2015>1900, SUPERB III Estate 2.0 TSI 4x4 2015>1900, YETI 1.2 TSI 2009>2017, YETI 1.4 TSI 2009>2017, YETI 1.4 TSI 4x4 2009>2017, YETI 1.6 2009>2017, YETI 1.6 TDI 2009>2017, YETI 1.8 TSI 4x4 2009>2017, YETI 2.0 TDI 2009>2017, YETI 2.0 TDI 4x4 2009>2017, OCTAVIA III 2.0 TSI 4x4 2014>1900, OCTAVIA III Combi 2.0 TSI 4x4 2012>1900;

MAN: TGE Box 2.0 TDI 2017>1900, TGE Box 2.0 TDI AWD 2017>1900, TGE Box 2.0 TDI RWD 2017>1900, TGE Box eTGE 2017>1900, TGE Platparam/Chassis 2.0 TDI 2016>1900, TGE Platparam/Chassis 2.0 TDI AWD 2016>1900, TGE Platparam/Chassis 2.0 TDI RWD 2016>1900

GS2023 // NEW //

REAR WHEEL SENSOR (RIGHT SIDE)



REPLACES / REEMPLAZA:

VW: 1K0927808, 0986594507, 1K0927807, 0986594561; **Bosch:** 0 986 594 507; **Delphi:** SS20034; **Meat & Doria:** 90050; **Mobiletron:** AB-EU012

APPLICATION / APLICACIÓN:

AUDI: A3 1.2 TSI 2003>2012, A3 1.4 TFSI 2003>2012, A3 1.6 2003>2012, A3 1.6 E-Power 2003>2012, A3 1.6 FSI 2003>2012, A3 1.6 TDI 2003>2012, A3 1.8 TFSI 2003>2012, A3 1.9 TDI 2003>2012, A3 2.0 FSI 2003>2012, A3 2.0 TDI 2003>2012, A3 2.0 TDI 16V 2003>2012, A3 2.0 TFSI 2003>2012, A3 Convertible 1.2 TFSI 2008>2013, A3 Convertible 1.4 TFSI 2008>2013, A3 Convertible 1.6 2008>2013, A3 Convertible 1.6 TDI 2008>2013, A3 Convertible 1.8 TFSI 2008>2013, A3 Convertible 1.9 TDI 2008>2013, A3 Convertible 2.0 TDI 2008>2013, A3 Convertible 2.0 TFSI 2008>2013, A3 Sportback 1.2 TSI 2004>2013, A3 Sportback 1.4 TFSI 2004>2013, A3 Sportback 1.6 2004>2013, A3 Sportback 1.6 E-Power 2004>2013, A3 Sportback 1.6 FSI 2004>2013, A3 Sportback 1.6 TDI 2004>2013, A3 Sportback 1.8 TFSI 2004>2013, A3 Sportback 1.9 TDI 2004>2013, A3 Sportback 2.0 FSI 2004>2013, A3 Sportback 2.0 TDI 2004>2013, A3 Sportback 2.0 TDI 16V 2004>2013, A3 Sportback 2.0 TFSI 2004>2013, A3 Sportback 2.0 TFSI quattro 2004>2013, Q3 1.4 TFSI 2011>2018, Q3 1.4 TSI 2011>2018, Q3 2.0 TDI 2011>2018, Q3 2.0 TFSI quattro 2011>2018, TT 1.8 TFSI 2006>2014, TT 2.0 TFSI 2006>2014, TT 2.5 RS quattro 2006>2014, TT Roadster 1.8 TFSI 2007>2014, TT Roadster 2.0 TFSI 2007>2014, TT Roadster 2.5 RS quattro 2007>2014, A1 1.0 TFSI 2010>2018, A1 1.4 TDI 2010>2018, A1 1.4 TFSI 2010>2018, A1 1.4 TSI 2010>2018, A1 1.6 TDI 2010>2018, A1 1.8 TFSI 2010>2018, A1 2.0 TFSI quattro 2010>2018, A1 S1 quattro 2010>2018, A1 Sportback 1.0 TFSI 2011>2018, A1 Sportback 1.4 TDI 2011>2018, A1 Sportback 1.4 TFSI 2011>2018, A1 Sportback 1.4 TSI 2011>2018, A1 Sportback 1.8 TFSI 2011>2018, A1 Sportback 1.8 TFSI quattro 2004>2013, A3 Sportback 2.0 TDI 16V quattro 2004>2013, A3 Sportback 2.0 TDI quattro 2004>2013, A3 Sportback 3.2 V6 quattro 2004>2013, A3 Sportback RS3 quattro 2004>2013, A3 Sportback S3 quattro 2004>2013, Q3 1.4 TFSI Flex 2011>2018, Q3 2.0 TDI quattro 2011>2018, Q3 2.0 TFSI quattro 2011>2018, Q3 RS perparamance 2.5 quattro 2011>2018, TT 2.0 TDI quattro 2006>2014, TT 2.0 TFSI quattro 2006>2014, TT 2.0 TTS quattro 2006>2014, TT 3.2 V6 quattro 2006>2014, TT 2.0 TFSI 2014>1900, TT Roadster 2.0 TDI quattro 2007>2014, TT Roadster 2.0 TFSI quattro 2007>2014, TT Roadster 2.0 TTS quattro 2007>2014, TT Roadster 3.2 V6 quattro 2007>2014, TT Roadster 2.0 TFSI 2014>1900;

SEAT: ALHAMBRA 1.4 TSI 2010>2011, ALHAMBRA 1.8 TSI 2010>2011, ALHAMBRA 2.0 TDI 2010>2011, ALHAMBRA 2.0 TDI 4Drive 2010>2011, ALHAMBRA 2.0 TSI 2010>2011, ALTEA 1.2 TSI 2004>2011, ALTEA 1.4 16V 2004>2011, ALTEA 1.4 TSI 2004>2011, ALTEA 1.6 2004>2011, ALTEA 1.6 LPG 2004>2011, ALTEA 1.6 Multifuel 2004>2011, ALTEA 1.6 TDI 2004>2011, ALTEA 1.8 TFSI 2004>2011, ALTEA 1.9 TDI 2004>2011, ALTEA 2.0 FSI 2004>2011, ALTEA 2.0 TDI 2004>2011, ALTEA 2.0 TDI 16V 2004>2011, ALTEA 2.0 TFSI 2004>2011, ALTEA XL 1.2 TSI 2006>2010, ALTEA XL 1.4 16V 2006>2010, ALTEA XL 1.4 TSI 2006>2010, ALTEA XL 1.6 2006>2010, ALTEA XL 1.6 LPG 2006>2010, ALTEA XL 1.6 Multifuel 2006>2010, ALTEA XL 1.6 TDI 2006>2010, ALTEA XL 1.8 TFSI 2006>2010, ALTEA XL 1.9 TDI 2006>2010, ALTEA XL 1.9 TDI 4x4 2006>2010, ALTEA XL 2.0 FSI 2006>2010, ALTEA XL 2.0 TDI 2006>2010, ALTEA XL 2.0 TDI 16V 2006>2010, ALTEA XL 2.0 TDI 16V 4x4 2006>2010...

CONTINUE...

GS2024 // NEW //

REAR WHEEL SENSOR (LEFT SIDE)

REPLACES / REEMPLAZA:

VW: 1K0927807, 0986594561, WHT003859A/0986594506; Bosch: 0 986 594 506; Delphi: SS20033; Meat & Doria: 90049; Mobiletron: AB-EU017

APPLICATION / APLICACIÓN:

AUDI: A3 1.2 TSI 2003>2012, A3 1.4 TFSI 2003>2012, A3 1.6 2003>2012, A3 1.6 E-Power 2003>2012, A3 1.6 FSI 2003>2012, A3 1.6 TDI 2003>2012, A3 1.8 TFSI 2003>2012, A3 1.9 TDI 2003>2012, A3 2.0 FSI 2003>2012, A3 2.0 TDI 2003>2012, A3 2.0 TDI 16V 2003>2012, A3 2.0 TFSI 2003>2012, A3 Convertible 1.2 TFSI 2008>2013, A3 Convertible 1.4 TFSI 2008>2013, A3 Convertible 1.6 2008>2013, A3 Convertible 1.6 TDI 2008>2013, A3 Convertible 1.8 TFSI 2008>2013, A3 Convertible 1.9 TDI 2008>2013, A3 Convertible 2.0 TDI 2008>2013, A3 Convertible 2.0 TFSI 2008>2013, A3 Sportback 1.2 TSI 2004>2013, A3 Sportback 1.4 TFSI 2004>2013, A3 Sportback 1.6 2004>2013, A3 Sportback 1.6 E-Power 2004>2013, A3 Sportback 1.6 FSI 2004>2013, A3 Sportback 1.6 TDI 2004>2013, A3 Sportback 1.8 TFSI 2004>2013, A3 Sportback 1.9 TDI 2004>2013, A3 Sportback 2.0 FSI 2004>2013, A3 Sportback 2.0 TDI 2004>2013, A3 Sportback 2.0 TDI 16V 2004>2013, A3 Sportback 2.0 TFSI 2004>2013, A3 Sportback 2.0 TFSI quattro 2004>2013, Q3 1.4 TFSI 2011>2018, Q3 1.4 TSI 2011>2018, Q3 2.0 TDI 2011>2018, Q3 2.0 TFSI quattro 2011>2018, TT 1.8 TFSI 2006>2014, TT 2.0 TFSI 2006>2014, TT Roadster 1.8 TFSI 2007>2014, TT Roadster 2.0 TFSI 2007>2014, A3 1.8 T 2003>2012, A3 1.8 TFSI quattro 2003>2012, A3 2.0 TDI 16V quattro 2003>2012, A3 2.0 TDI quattro 2003>2012, A3 2.0 TFSI quattro 2003>2012, A3 3.2 V6 quattro 2003>2012, A3 S3 quattro 2003>2012, A3 Sportback 1.8 TFSI quattro 2004>2013, A3 Sportback 2.0 TDI 16V quattro 2004>2013, A3 Sportback 2.0 TDI quattro 2004>2013, A3 Sportback 3.2 V6 quattro 2004>2013, A3 Sportback RS3 quattro 2004>2013, A3 Sportback S3 quattro 2004>2013, Q3 1.4 TFSI Flex 2011>2018, Q3 2.0 TDI quattro 2011>2018, Q3 2.0 TFSI 2011>2018, Q3 RS 2.5 quattro 2011>2018, Q3 RS perparamance 2.5 quattro 2011>2018, TT 2.0 TDI quattro 2006>2014, TT 2.0 TFSI quattro 2006>2014, TT 2.0 TTS quattro 2006>2014, TT 2.5 RS quattro 2006>2014, TT 3.2 V6 quattro 2006>2014, TT 2.0 TFSI 1900, TT Roadster 2.0 TDI quattro 2007>2014, TT Roadster 2.0 TFSI quattro 2007>2014, TT Roadster 2.0 TTS quattro 2007>2014, TT Roadster 2.5 RS quattro 2007>2014, TT Roadster 3.2 V6 quattro 2007>2014, TT Roadster 2.0 TFSI 1900, SEAT: ALHAMBRA 1.4 TSI 2010>2011, ALHAMBRA 1.8 TSI 2010>2011, ALHAMBRA 2.0 TDI 2010>2011, ALHAMBRA 2.0 TDI 4Drive 2010>2011, ALHAMBRA 2.0 TSI 2010>2011, ALTEA 1.2 TSI 2004>2011, ALTEA 1.4 16V 2004>2011, ALTEA 1.4 TSI 2004>2011, ALTEA 1.6 2004>2011, ALTEA 1.6 LPG 2004>2011, ALTEA 1.6 Multifuel 2004>2011, ALTEA 1.6 TDI 2004>2011, ALTEA 1.8 TFSI 2004>2011, ALTEA 1.9 TDI 2004>2011, ALTEA 2.0 FSI 2004>2011, ALTEA 2.0 TDI 2004>2011, ALTEA 2.0 TDI 16V 2004>2011, ALTEA 2.0 TFSI 2004>2011, ALTEA XL 1.2 TSI 2006>2010, ALTEA XL 1.4 16V 2006>2010, ALTEA XL 1.4 TSI 2006>2010, ALTEA XL 1.6 2006>2010, ALTEA XL 1.6 LPG 2006>2010, ALTEA XL 1.6 Multifuel 2006>2010, ALTEA XL 1.6 TDI 2006>2010, ALTEA XL 1.8 TFSI 2006>2010, ALTEA XL 1.9 TDI 2006>2010, ALTEA XL 1.9 TDI 4x4 2006>2010, ALTEA XL 2.0 FSI 2006>2010, ALTEA XL 2.0 TDI 2006>2010, ALTEA XL 2.0 TDI 16V 2006>2010, ALTEA XL 2.0 TDI 16V 4x4 2006>2010, ALTEA XL 2.0 TFSI 2006>2010, ALTEA XL 2.0 TFSI 4x4 2006>2010, LEON 1.2 TSI 2005>2012, LEON 1.4 16V 2005>2012, LEON 1.4 TSI 2005>2012, LEON 1.6 2005>2012, LEON 1.6 LPG 2005>2012, LEON 1.6 Multifuel 2005>2012, LEON 1.6 TDI 2005>2012, LEON 1.8 TSI 2005>2012, LEON 1.8 TSI 2005>2012, LEON 1.9 TDI 2005>2012, LEON 2.0 Cupra R 2005>2012, LEON 2.0 FSI 2005>2012, LEON 2.0 TDI 2005>2012, LEON 2.0 TDI 16V 2005>2012, LEON 2.0 TFSI 2005>2012, TOLEDO III 1.4 16V 2004>2009, TOLEDO III 1.4 TSI 2004>2009, TOLEDO III 1.6 2004>2009, TOLEDO III 1.8 TFSI 2004>2009, TOLEDO III 1.9 TDI 2004>2009, TOLEDO III 2.0 FSI 2004>2009, TOLEDO III 2.0 TDI 2004>2009, TOLEDO III 2.0 TDI 16V 2004>2009, TOLEDO III 2.0 TFSI 2004>2009, ALTEA XL 2.0 TDI 4x4 2006>2010;

VW: BEETLE 1.2 TSI 2011>2019, BEETLE 1.2 TSI 16V 2011>2019, BEETLE 1.4 TSI 2011>2019, BEETLE 1.6 TDI 2011>2019, BEETLE 2.0 TDI 2011>2019, BEETLE 2.0 TSI 2011>2019, BEETLE Convertible 1.2 TSI 2011>2019, BEETLE Convertible 1.2 TSI 16V 2011>2019, BEETLE Convertible 1.4 TSI 2011>2019, BEETLE Convertible 1.4 TSI 2011>2019, BEETLE Convertible 1.6 TDI 2011>2019, BEETLE Convertible 2.0 TDI 2011>2019, BEETLE Convertible 2.0 TSI 2011>2019, EOS 1.4 TSI 2006>2015, EOS 1.6 FSI 2006>2015, EOS 2.0 FSI 2006>2015, EOS 2.0 TDI 2006>2015, EOS 2.0 TDI 16V 2006>2015, EOS 2.0 TFSI 2006>2015, EOS 2.0 TFSI 2006>2015, EOS 3.2 V6 2006>2015, EOS 3.6 V6 2006>2015, GOLF PLUS 1.2 TSI 2004>2013, GOLF PLUS 1.4 16V 2004>2013, GOLF PLUS 1.4 FSI 2004>2013, GOLF PLUS 1.4 TSI 2004>2013, GOLF PLUS 1.6 2004>2013, GOLF PLUS 1.6 BiFuel 2004>2013, GOLF PLUS 1.6 FSI 2004>2013, GOLF PLUS 1.6 MultiFuel 2004>2013, GOLF PLUS 1.6 TDI 2004>2013, GOLF PLUS 1.9 TDI 2004>2013, GOLF PLUS 2.0 FSI 2004>2013, GOLF PLUS 2.0 TDI 2004>2013, GOLF PLUS 2.0 TDI 16V 2004>2013, GOLF PLUS Van 1.2 TSI 2009>2014, GOLF PLUS Van 1.6 TDI 2009>2014, GOLF PLUS Van 2.0 TDI 2009>2014, GOLF V 1.4 16V 2003>2009, GOLF V 1.4 TSI 2003>2009, GOLF V 1.4 TSI 2003>2009, GOLF V 1.6 2003>2009, GOLF V 1.6 FSI 2003>2009, GOLF V 1.6 MultiFuel 2003>2009, GOLF V 1.9 TDI 2003>2009, GOLF V 1.9 TDI 4motion 2003>2009, GOLF V 2.0 2003>2009, GOLF V 2.0 FSI 2003>2009, GOLF V 2.0 FSI 4motion 2003>2009, GOLF V 2.0 GTI 2003>2009, GOLF V 2.0 SDI 2003>2009, GOLF V 2.0 TDI 2003>2009, GOLF V 2.0 TDI 16V 2003>2009, GOLF V 2.0 TDI 16V 4motion 2003>2009, GOLF V 2.0 TDI 4motion 2003>2009, GOLF V 2.0 TDI 4motion 2003>2009, GOLF V Variant 1.4 2007>2009, GOLF V Variant 1.4 TSI 2007>2009, GOLF V Variant 1.6 2007>2009, GOLF V Variant 1.6 MultiFuel 2007>2009, GOLF V Variant 1.9 TDI 2007>2009, GOLF V Variant 1.9 TDI 4motion 2007>2009, GOLF V Variant 2.0 2007>2009, GOLF V Variant 2.0 TDI 2007>2009, GOLF V Variant 2.0 TDI 16V 2007>2009, GOLF V Variant 2.5 2007>2009, GOLF VAN VI Variant 1.2 TSI 2009>2014, GOLF VAN VI Variant 1.4 TSI 2009>2014, GOLF VAN VI Variant 1.6 TDI 2009>2014, GOLF VAN VI Variant 1.6 TDI BlueMotion 2009>2014, GOLF VAN VI Variant 2.0 TDI 2009>2014, GOLF VI 1.2 TSI 2008>2013, GOLF VI 1.4 2008>2013, GOLF VI 1.4 TSI 2008>2013, GOLF VI 1.6 2008>2013, GOLF VI 1.6 BiFuel 2008>2013, GOLF VI 1.6 MultiFuel 2008>2013, GOLF VI 1.6 TDI 2008>2013, GOLF VI 1.8 TSI 2008>2013, GOLF VI 2.0 GTI 2008>2013, GOLF VI 2.0 TDI 2008>2013, GOLF VI Convertible 1.2 TSI 2011>2016, GOLF VI Convertible 1.4 TSI 2011>2016, GOLF VI Convertible 1.6 TDI 2011>2016, GOLF VI Van 1.2 TSI 2008>2012, GOLF VI Van 1.2 TSI BlueMotion 2008>2012, GOLF VI Van 1.4 TSI 2008>2012, GOLF VI Van 1.6 TDI 2008>2012, GOLF VI Van 1.6 TDI BlueMotion 2008>2012, GOLF VI Van 2.0 GTI 2008>2012, GOLF VI Van 2.0 TDI 2008>2012, GOLF VI Van TSI 2008>2012, GOLF VI Variant 1.2 TSI 2009>2014, GOLF VI Variant 1.4 2009>2014, GOLF VI Variant 1.4 TSI 2009>2014, GOLF VI Variant 1.6 2009>2014, GOLF VI Variant 1.6 BiFuel 2009>2014, GOLF VI Variant 1.6 MultiFuel 2009>2014, GOLF VI Variant 1.6 TDI 2009>2014, GOLF VI Variant 1.6 TDI 4motion 2009>2014, GOLF VI Variant 2.0 TDI 2009>2014, GOLF VI Variant 2.5 2009>2014, JETTA III 1.4 TSI 2004>2010, JETTA III 1.6 2004>2010, JETTA III 1.6 FSI 2004>2010, JETTA III 1.6 MultiFuel 2004>2010, JETTA III 1.6 TDI 2004>2010, JETTA III 1.9 TDI 2004>2010, JETTA III 2.0 FSI 2004>2010, JETTA III 2.0 TDI 2004>2010, JETTA III 2.0 TDI 16V 2004>2010, JETTA III 2.0 TFSI 2004>2010, JETTA III 2.5 2004>2010, JETTA IV 1.2 TSI 2010>2018, JETTA IV 1.2 TSI 16V 2010>2018, JETTA IV 1.4 TSI 2010>2018, JETTA IV 1.4 TSI Hybrid 2010>2018, JETTA IV 1.6 MPI 2010>2018, JETTA IV 1.6 TDI 2010>2018, JETTA IV 2.0 2010>2018, JETTA IV 2.0 Flex 2010>2018, JETTA IV 2.0 TDI 2010>2018, JETTA IV 2.0 TSI 2010>2018, JETTA Saloon 1.4 TSI 2017>1900, PASSAT 1.4 TSI 2005>2010, PASSAT 1.4 TSI EcoFuel 2005>2010, PASSAT 1.6 2005>2010, PASSAT 1.6 FSI 2005>2010, PASSAT 1.6 TDI 2005>2010, PASSAT 1.8 TSI 2005>2010, PASSAT 1.9 TDI 2005>2010, PASSAT 2.0 BlueTDI 2005>2010, PASSAT 2.0 FSI 2005>2010, PASSAT 2.0 TDI 2005>2010, PASSAT 2.0 TDI 16V 2005>2010, PASSAT 2.0 TDI 16V 4motion 2005>2010, PASSAT 2.0 TDI 4motion 2005>2010, PASSAT 2.5 2011>1900, PASSAT CC 1.8 TSI 2008>2012, PASSAT CC 2.0 BlueTDI 2008>2012, PASSAT CC 2.0 TDI 2008>2012, PASSAT CC 2.0 TSI 2008>2012, PASSAT CC 3.6 FSI 2008>2012, PASSAT Variant 1.4 TSI 2005>2011, PASSAT Variant 1.4 TSI EcoFuel 2005>2011, PASSAT Variant 1.6 2005>2011, PASSAT Variant 1.6 FSI 2005>2011, PASSAT Variant 1.6 TDI 2005>2011, PASSAT Variant 1.8 TSI 2005>2011, PASSAT Variant 1.9 TDI 2005>2011, PASSAT Variant 2.0 BlueTDI 2005>2011, PASSAT Variant 2.0 FSI 2005>2011, PASSAT Variant 2.0 TDI 2005>2011, PASSAT Variant 2.0 TDI 16V 2005>2011, PASSAT Variant 2.0 TDI 16V 4motion 2005>2011, PASSAT Variant 2.0 TDI 4motion 2005>2011, SCIROCCO 1.4 TSI 2008>2017, SCIROCCO 2.0 R 2008>2017, SCIROCCO 2.0 TDI 2008>2017, SCIROCCO 2.0 TSI 2008>2017, SCIROCCO Van 1.4 TSI 2008>2014, SCIROCCO Van 2.0 TDI 2008>2014, SCIROCCO Van 2.0 FSI 2008>2014, SHARAN 1.4 TSI 2010>1900, SHARAN 2.0 TDI 2010>1900, SHARAN 2.0 TSI 2010>1900, TIGUAN 1.4 TSI 2007>2018, TIGUAN 2.0 TDI 2007>2018, TOURAN 1.4 FSI 2003>2010, TOURAN 1.4 TSI 2003>2010, TOURAN 1.4 TSI EcoFuel 2003>2010, TOURAN 1.6 2003>2010, TOURAN 1.6 BiFuel 2003>2010, TOURAN 1.6 FSI 2003>2010, TOURAN 1.9 TDI 2003>2010, TOURAN 2.0 EcoFuel 2003>2010, TOURAN 2.0 FSI 2003>2010, TOURAN 2.0 TDI 2003>2010, TOURAN 2.0 TDI 16V 2003>2010, TOURAN 1.2 TSI 2010>2015, TOURAN 1.4 TSI 2010>2015, TOURAN 1.4 TSI 2010>2015, TOURAN 1.4 TSI EcoFuel 2010>2015, TOURAN 1.6 TDI 2010>2015, TOURAN 2.0 TDI 2010>2015, BEETLE 1.8 TSI 2011>2019, BEETLE 2.5 2011>2019, BEETLE Convertible 1.8 TSI 2011>2019, BEETLE Convertible 2.5 2011>2019, CC 1.4 TSI 2011>2016, CC 1.4 TSI MultiFuel 2011>2016, CC 1.8 TSI 2011>2016, CC 2.0 TDI 2011>2016, CC 2.0 TSI 2011>2016, GOLF V 1.8 T 2003>2009, GOLF V 2.5 2003>2009, GOLF VI 2.0 2008>2013, GOLF VI 2.0 R 4motion 2008>2013, GOLF VI 2.5 2008>2013, GOLF VI Blue E-Motion 2008>2013, GOLF VI Convertible 1.2 TSI 16V 2011>2016, GOLF VI Convertible 2.0 GTI 2011>2016, GOLF VI Convertible 2.0 R 2011>2016, GOLF VI Convertible 2.0 TDI 2011>2016, GOLF VI Convertible 2.0 TSI 2011>2016, JETTA III 2.0 2004>2010, JETTA III 2.8 VR6 2004>2010, JETTA IV 1.8 TSI 2010>2018, JETTA IV 2.5 2010>2018, PASSAT 1.4 TSI 2010>2014, PASSAT 1.4 TSI EcoFuel 2010>2014, PASSAT 1.4 TSI MultiFuel 2010>2014, PASSAT 1.6 TDI 2010>2014, PASSAT 1.8 TSI 2010>2014, PASSAT 2.0 TDI 2010>2014, PASSAT 2.0 TSI 2010>2014, PASSAT 2.0 TSI 2005>2010, PASSAT 3.6 FSI 2005>2010, PASSAT CC 1.4 TSI MultiFuel 2008>2012, PASSAT Variant 1.4 TSI 2010>2015, PASSAT Variant 1.4 TSI EcoFuel 2010>2015, PASSAT Variant 1.4 TSI MultiFuel 2010>2015, PASSAT Variant 1.6 TDI 2010>2015, PASSAT Variant 1.8 TSI 2010>2015, PASSAT Variant 2.0 TDI 2010>2015, PASSAT Variant 2.0 TSI 2010>2015, PASSAT Variant 2.0 TSI 2005>2011, PASSAT Variant 3.6 FSI 2005>2011, SHARAN 1.8 TSI 2010>1900, TIGUAN 2.0 TFSI 2007>2018, TIGUAN 2.0 TFSI 4motion 2007>2018;

SKODA: OCTAVIA II 1.2 TSI 2004>2013, OCTAVIA II 1.4 2004>2013, OCTAVIA II 1.4 TSI 2004>2013, OCTAVIA II 1.6 2004>2013, OCTAVIA II 1.6 FSI 2004>2013, OCTAVIA II 1.6 LPG 2004>2013, OCTAVIA II 1.6 MultiFuel 2004>2013, OCTAVIA II 1.6 TDI 2004>2013, OCTAVIA II 1.8 TSI 2004>2013, OCTAVIA II 1.9 TDI 2004>2013, OCTAVIA II 2.0 FSI 2004>2013, OCTAVIA II 2.0 RS 2004>2013, OCTAVIA II 2.0 TDI 2004>2013, OCTAVIA II 2.0 TDI 16V 2004>2013, OCTAVIA II 2.0 TDI RS 2004>2013...

CONTINUE...



GS2024 // NEW //
REAR WHEEL SENSOR (LEFT SIDE)
REPLACES / REEMPLAZA:
VW: 1K0927807, 0986594561, WHT003859A/0986594506; **Bosch:** 0 986 594 506; **Delphi:** SS20033; **Meat & Doria:** 90049; **Mobiletron:** AB-EU017

APPLICATION / APLICACIÓN:
SKODA: OCTAVIA II Combi 1.2 TSI 2004>2013, OCTAVIA II Combi 1.4 2004>2013, OCTAVIA II Combi 1.4 TSI 2004>2013, OCTAVIA II Combi 1.6 2004>2013, OCTAVIA II Combi 1.6 FSI 2004>2013, OCTAVIA II Combi 1.6 LPG 2004>2013, OCTAVIA II Combi 1.6 MultiFuel 2004>2013, OCTAVIA II Combi 1.6 TDI 2004>2013, OCTAVIA II Combi 1.8 TSI 2004>2013, OCTAVIA II Combi 1.9 TDI 2004>2013, OCTAVIA II Combi 2.0 FSI 2004>2013, OCTAVIA II Combi 2.0 RS 2004>2013, OCTAVIA II Combi 2.0 TDI 2004>2013, OCTAVIA II Combi 2.0 TDI 16V 2004>2013, OCTAVIA II Combi 2.0 TDI RS 2004>2013, SUPERB II 1.4 TSI 2008>2015, SUPERB II 1.6 TDI 2008>2015, SUPERB II 1.8 TSI 2008>2015, SUPERB II 1.9 TDI 2008>2015, SUPERB II 2.0 TDI 2008>2015, SUPERB II 2.0 TDI 16V 2008>2015, SUPERB II 2.0 TSI 2008>2015, SUPERB II Estate 1.4 TSI 2009>2015, SUPERB II Estate 1.6 TDI 2009>2015, SUPERB II Estate 1.8 TSI 2009>2015, SUPERB II Estate 1.9 TDI 2009>2015, SUPERB II Estate 2.0 TDI 2009>2015, SUPERB II Estate 2.0 TDI 16V 2009>2015, SUPERB II Estate 2.0 TSI 2009>2015, SUPERB III Estate 2.0 TDI 2015>1900, YETI 1.2 TSI 2009>2017, YETI 1.4 TSI 2009>2017, YETI 1.6 2009>2017, YETI 1.6 TDI 2009>2017, YETI 2.0 TDI 2009>2017, OCTAVIA II Combi 2.0 FSI 4x4 2004>2013, OCTAVIA II Combi 2.0 TDI 4x4 2004>2013, OCTAVIA II Combi 2.0 TDI 4x4 2008>2015, SUPERB II 1.8 TSI 4x4 2008>2015, SUPERB II 2.0 TDI 16V 4x4 2008>2015, SUPERB II 2.0 TDI 4x4 2008>2015, SUPERB II 3.6 FSI 4x4 2008>2015, SUPERB II Estate 1.8 TSI 4x4 2009>2015, SUPERB II Estate 2.0 TDI 16V 4x4 2009>2015, SUPERB II Estate 2.0 TDI 4x4 2009>2015, SUPERB II Estate 3.6 V6 4x4 2009>2015

GS2025 // NEW //
FRONT WHEEL SENSOR (BOTH SIDES)
REPLACES / REEMPLAZA:
Audi: 8E0927803, 8E0927803A, 0265006683, 0265006682; **Meat & Doria:** 90068; **Mobiletron:** AB-EU107

APPLICATION / APLICACIÓN:
AUDI: A4 1.6 2000>2004, A4 1.8 T 2000>2004, A4 1.8 T quattro 2000>2004, A4 1.9 TDI 2000>2004, A4 1.9 TDI quattro 2000>2004, A4 2.0 2000>2004, A4 2.0 FSI 2000>2004, A4 2.4 2000>2004, A4 2.5 TDI 2000>2004, A4 2.5 TDI quattro 2000>2004, A4 3.0 2000>2004, A4 3.0 quattro 2000>2004, A4 S4 quattro 2000>2004, A4 1.6 2004>2008, A4 1.8 T 2004>2008, A4 1.8 T quattro 2004>2008, A4 1.9 TDI 2004>2008, A4 2.0 2004>2008, A4 2.0 TDI 2004>2008, A4 2.0 TDI 16V 2004>2008, A4 2.0 TDI quattro 2004>2008, A4 2.0 TFSI 2004>2008, A4 2.0 TFSI quattro 2004>2008, A4 2.5 TDI 2004>2008, A4 2.7 TDI 2004>2008, A4 3.0 2004>2008, A4 3.0 quattro 2004>2008, A4 3.0 TDI quattro 2004>2008, A4 3.2 FSI 2004>2008, A4 3.2 FSI quattro 2004>2008, A4 RS4 quattro 2004>2008, A4 S4 quattro 2004>2008, A4 Avant 1.6 2001>2004, A4 Avant 1.8 T 2001>2004, A4 Avant 1.8 T quattro 2001>2004, A4 Avant 1.9 TDI 2001>2004, A4 Avant 1.9 TDI quattro 2001>2004, A4 Avant 2.0 2001>2004, A4 Avant 2.0 FSI 2001>2004, A4 Avant 2.4 2001>2004, A4 Avant 2.5 TDI 2001>2004, A4 Avant 2.5 TDI quattro 2001>2004, A4 Avant 3.0 2001>2004, A4 Avant 3.0 quattro 2001>2004, A4 Avant S4 quattro 2001>2004, A4 Avant 1.6 2004>2008, A4 Avant 1.8 T 2004>2008, A4 Avant 1.8 T quattro 2004>2008, A4 Avant 1.9 TDI 2004>2008, A4 Avant 2.0 2004>2008, A4 Avant 2.0 TDI 2004>2008, A4 Avant 2.0 TDI 16V 2004>2008, A4 Avant 2.0 TDI quattro 2004>2008, A4 Avant 2.0 TFSI 2004>2008, A4 Avant 2.0 TFSI quattro 2004>2008, A4 Avant 2.5 TDI 2004>2008, A4 Avant 2.7 TDI 2004>2008, A4 Avant 3.0 2004>2008, A4 Avant 3.0 quattro 2004>2008, A4 Avant 3.0 TDI quattro 2004>2008, A4 Avant 3.2 FSI 2004>2008, A4 Avant 3.2 FSI quattro 2004>2008, A4 Avant RS4 quattro 2004>2008, A4 Avant S4 quattro 2004>2008, A4 Convertible 1.8 T 2002>2009, A4 Convertible 1.8 T quattro 2002>2009, A4 Convertible 2.0 2002>2009, A4 Convertible 2.0 TDI 2002>2009, A4 Convertible 2.0 TFSI 16V 2002>2009, A4 Convertible 2.4 2002>2009, A4 Convertible 2.5 TDI 2002>2009, A4 Convertible 3.0 2002>2009, A4 Convertible 3.0 quattro 2002>2009, A4 Convertible 3.0 TDI quattro 2002>2009, A4 Convertible 3.2 FSI 2002>2009, A4 Convertible 3.2 FSI quattro 2002>2009, A4 Convertible S4 quattro 2002>2009

GS2026 // NEW //
REAR WHEEL SENSOR (BOTH SIDES)
REPLACES / REEMPLAZA:
Audi: 8E0927807B, 0265006681; **Bosch:** 0 265 006 681; **Delphi:** SS20286; **Meat & Doria:** 90508; **Mobiletron:** AB-EU111

APPLICATION / APLICACIÓN:
AUDI: A4 1.6 2000>2004, A4 1.8 T 2000>2004, A4 1.8 T quattro 2000>2004, A4 1.9 TDI 2000>2004, A4 1.9 TDI quattro 2000>2004, A4 2.0 2000>2004, A4 2.0 FSI 2000>2004, A4 2.4 2000>2004, A4 2.5 TDI 2000>2004, A4 2.5 TDI quattro 2000>2004, A4 3.0 2000>2004, A4 3.0 quattro 2000>2004, A4 S4 quattro 2000>2004, A4 1.6 2004>2008, A4 1.8 T 2004>2008, A4 1.8 T quattro 2004>2008, A4 1.9 TDI 2004>2008, A4 2.0 2004>2008, A4 2.0 TDI 2004>2008, A4 2.0 TDI 16V 2004>2008, A4 2.0 TDI quattro 2004>2008, A4 2.0 TFSI 2004>2008, A4 2.0 TFSI quattro 2004>2008, A4 2.5 TDI 2004>2008, A4 2.7 TDI 2004>2008, A4 3.0 2004>2008, A4 3.0 quattro 2004>2008, A4 3.0 TDI quattro 2004>2008, A4 3.2 FSI 2004>2008, A4 3.2 FSI quattro 2004>2008, A4 RS4 quattro 2004>2008, A4 S4 quattro 2004>2008, A4 Avant 1.6 2001>2004, A4 Avant 1.8 T 2001>2004, A4 Avant 1.8 T quattro 2001>2004, A4 Avant 1.9 TDI 2001>2004, A4 Avant 1.9 TDI quattro 2001>2004, A4 Avant 2.0 2001>2004, A4 Avant 2.0 FSI 2001>2004, A4 Avant 2.4 2001>2004, A4 Avant 2.5 TDI 2001>2004, A4 Avant 2.5 TDI quattro 2001>2004, A4 Avant 3.0 2001>2004, A4 Avant 3.0 quattro 2001>2004, A4 Avant S4 quattro 2001>2004, A4 Avant 1.6 2004>2008, A4 Avant 1.8 T 2004>2008, A4 Avant 1.8 T quattro 2004>2008, A4 Avant 1.9 TDI 2004>2008, A4 Avant 2.0 2004>2008, A4 Avant 2.0 TDI 2004>2008, A4 Avant 2.0 TDI 16V 2004>2008, A4 Avant 2.0 TDI quattro 2004>2008, A4 Avant 2.0 TFSI 2004>2008, A4 Avant 2.0 TFSI quattro 2004>2008, A4 Avant 2.5 TDI 2004>2008, A4 Avant 2.7 TDI 2004>2008, A4 Avant 3.0 2004>2008, A4 Avant 3.0 quattro 2004>2008, A4 Avant 3.0 TDI quattro 2004>2008, A4 Avant 3.2 FSI 2004>2008, A4 Avant 3.2 FSI quattro 2004>2008, A4 Avant RS4 quattro 2004>2008, A4 Avant S4 quattro 2004>2008, A4 Convertible 1.8 T 2002>2009, A4 Convertible 1.8 T quattro 2002>2009, A4 Convertible 2.0 2002>2009, A4 Convertible 2.0 TDI 2002>2009, A4 Convertible 2.0 TFSI 16V 2002>2009, A4 Convertible 2.4 2002>2009, A4 Convertible 2.5 TDI 2002>2009, A4 Convertible 3.0 2002>2009, A4 Convertible 3.0 quattro 2002>2009, A4 Convertible 3.0 TDI quattro 2002>2009, A4 Convertible 3.2 FSI 2002>2009, A4 Convertible 3.2 FSI quattro 2002>2009, A4 Convertible S4 quattro 2002>2009

GS2027 // NEW //
FRONT WHEEL SENSOR (BOTH SIDES)
REPLACES / REEMPLAZA:
Citroën: 4545C7, 96469712, 0265007665; **Bosch:** 0 265 007 665; **Delphi:** SS20380; **Meat & Doria:** 90589; **Mobiletron:** AB-EU294

APPLICATION / APLICACIÓN:
CITROËN: Xsara Picasso 1.6 1999>2012, Xsara Picasso 1.6 16V 1999>2012, Xsara Picasso 1.6 Chrono 1999>2012, Xsara Picasso 1.6 Flex 1999>2012, Xsara Picasso 1.6 HDi 1999>2012, Xsara Picasso 1.8 16V 1999>2012, Xsara Picasso 2.0 16V 1999>2012, Xsara Picasso 2.0 HDi 1999>2012, Xsara Picasso 1.6 16V LPG 1999>2012, Xsara Picasso 1.8 SX 1999>2012

GS2028 // NEW //
REAR WHEEL SENSOR (LEFT SIDE)
REPLACES / REEMPLAZA:
Citroën: 4545C9, 96469709; **Bosch:** 0 265 007 668; **A.B.S.:** 30640; **Meat & Doria:** 90590

APPLICATION / APLICACIÓN:
CITROËN: Berlingo First Box 1.4 Bivalent 2002>2011, Berlingo First Box 1.4 I 1999>2008, Berlingo First Box 1.4 I 1996>2011, Berlingo First Box 1.4 I Bivalent 2003>2005, Berlingo First Box 1.6 16V 2000>2015, Berlingo First Box 1.6 16V 2000>2008, Berlingo First Box 1.6 Hdi 75 2005>2011, Berlingo First Box 1.6 Hdi 90 2005>2011, Berlingo First Box 1.9 D 70 1999>2011, Berlingo First Box 1.9 D 70 4Wd 1998>2006, Berlingo First Box 2.0 Hdi 90 1999>2011, Berlingo First Box 2.0 Hdi 90 4Wd 2000>2005, Berlingo First Box Electric 1998>2005, Berlingo First Mpv 1.1 I 1996>2008, Berlingo First Mpv 1.4 2002>2006, Berlingo First Mpv 1.4 Bivalent 2002>2011, Berlingo First Mpv 1.4 I 1996>2011, Berlingo First Mpv 1.4 I Bivalent 2003>2008, Berlingo First Mpv 1.6 16V 2000>2011, Berlingo First Mpv 1.6 Hdi 75 2005>2011, Berlingo First Mpv 1.6 Hdi 90 2005>2008, Berlingo First Mpv 1.9 D 1998>2005, Berlingo First Mpv 1.9 D 4Wd 1998>2005, Berlingo First Mpv 2.0 Hdi 4X4 2002>2005, Berlingo First Mpv 2.0 Hdi 90 1999>2005, Berlingo First Mpv Electric 1998>2005, Xsara Picasso 1.6 1999>2010, Xsara Picasso 1.6 16V 2000>2015, Xsara Picasso 1.6 Chrono 2001>2004, Xsara Picasso 1.6 Flex 2006>2014, Xsara Picasso 1.6 Hdi 2004>2011, Xsara Picasso 1.8 16V 2000>2005, Xsara Picasso 2.0 16V 2003>2012, Xsara Picasso 2.0 Hdi 1999>2011;

PEUGEOT: Hoggar 1.4 Flex 2010>2015, Hoggar 1.6 1999>2010, Hoggar 1.6 Flex 2006>2014, Partner Box 1.4 2002>2006, Partner Box 1.4 Bifuel 2003>2006, Partner Box 1.6 Hdi 90 2005>2015, Partner Box 1.9 D 1996>2015, Partner Box 1.9 D 4X4 2004>2011, Partner Box 2.0 Hdi 1999>2011, Partner Box 2.0 Hdi 4X4 2004>2005, Partner Comspace 1.4 2002>2006, Partner Comspace 1.6 16V 2000>2015, Partner Comspace 1.6 Hdi 90 2005>2015, Partner Comspace 1.9 4X4 2004>2011, Partner Comspace 2.0 Hdi 1999>2011, Partner Comspace 2.0 Hdi 4X4 2004>2005, Partner Platform/Chassis 1.6 1999>2010, Partner Platform/Chassis 1.9 D 1996>2015

GS2029 // NEW //
REAR WHEEL SENSOR (RIGHT SIDE)
REPLACES / REEMPLAZA:
Citroën: 4545E6, 4545E0, 96585998; **Bosch:** 0 265 007 883; **A.B.S.:** 31219; **Delphi:** SS20348; **Meat & Doria:** 90592

APPLICATION / APLICACIÓN:
CITROËN: Berlingo First Box 1.4 Bivalent 2002>2011, Berlingo First Box 1.4 I 1999>2008, Berlingo First Box 1.4 I 1996>2011, Berlingo First Box 1.4 I Bivalent 2003>2005, Berlingo First Box 1.6 16V 2000>2015, Berlingo First Box 1.6 16V 2000>2008, Berlingo First Box 1.6 Hdi 75 2005>2011, Berlingo First Box 1.6 Hdi 90 2005>2011, Berlingo First Box 1.9 D 70 1999>2011, Berlingo First Box 1.9 D 70 4Wd 1998>2006, Berlingo First Box 2.0 Hdi 90 1999>2011, Berlingo First Box 2.0 Hdi 90 4Wd 2000>2005, Berlingo First Box Electric 1998>2005, Berlingo First Mpv 1.1 I 1996>2008, Berlingo First Mpv 1.4 2002>2006, Berlingo First Mpv 1.4 Bivalent 2002>2011, Berlingo First Mpv 1.4 I 1996>2011, Berlingo First Mpv 1.4 I Bivalent 2003>2008, Berlingo First Mpv 1.6 16V 2000>2011, Berlingo First Mpv 1.6 Hdi 75 2005>2011, Berlingo First Mpv 1.6 Hdi 90 2005>2008, Berlingo First Mpv 1.9 D 1998>2005, Berlingo First Mpv 1.9 D 4Wd 1998>2005, Berlingo First Mpv 2.0 Hdi 4X4 2002>2005, Berlingo First Mpv 2.0 Hdi 90 1999>2005, Berlingo First Mpv Electric 1998>2005, Xsara Picasso 1.6 1999>2010, Xsara Picasso 1.6 16V 2000>2015, Xsara Picasso 1.6 Chrono 2001>2004, Xsara Picasso 1.6 Flex 2006>2014, Xsara Picasso 1.6 Hdi 2004>2011, Xsara Picasso 1.8 16V 2000>2005, Xsara Picasso 2.0 16V 2003>2012, Xsara Picasso 2.0 Hdi 1999>2011;

PEUGEOT: Hoggar 1.4 Flex 2010>2015, Hoggar 1.6 1999>2010, Hoggar 1.6 Flex 2006>2014, Partner Box 1.4 2002>2006, Partner Box 1.4 Bifuel 2003>2006, Partner Box 1.6 Hdi 90 2005>2015, Partner Box 1.9 D 1996>2015, Partner Box 1.9 D 4X4 2004>2011, Partner Box 2.0 Hdi 1999>2011, Partner Box 2.0 Hdi 4X4 2004>2005, Partner Comspace 1.4 2002>2006, Partner Comspace 1.6 16V 2000>2015, Partner Comspace 1.6 Hdi 90 2005>2015, Partner Comspace 1.9 D 4X4 2004>2011, Partner Comspace 2.0 Hdi 1999>2011, Partner Comspace 2.0 Hdi 4X4 2004>2005, Partner Platform/Chassis 1.6 1999>2010, Partner Platform/Chassis 1.9 D 1996>2015

GS2031
FRONT WHEEL SENSOR (RIGHT SIDE)
REPLACES / REEMPLAZA:
Honda: 57450S4KA52, 57450S84A51, 57450S84A52

APPLICATION / APLICACIÓN:
Honda: Accord Mk7 Coupe 2.0i 16v

PS: set of GS2030

GS2032 // NEW //
FRONT WHEEL SENSOR (LEFT SIDE) AND REAR WHEEL SENSOR (RIGHT SIDES)
REPLACES / REEMPLAZA:
Audi: 4E0927803A, 4E0927803D, 4E0927803F, 0265007930, 0265007728; **Bosch:** 0 265 007 728, 0 265 007 930; **Cargo:** 181878; **Meat & Doria:** 90506;

Mobiletron: AB-EU139

APPLICATION / APLICACIÓN:
PORSCHE: 918 Spyder 4.6 2013>1900;

AUDI: A4 1.8 TFSI 2007>2015, A4 1.8 TFSI quattro 2007>2015, A4 2.0 TDI 2007>2015, A4 2.0 TDI quattro 2007>2015, A4 2.0 TFSI 2007>2015, A4 2.0 TFSI flexible fuel 2007>2015, A4 2.0 TFSI flexible fuel quattro 2007>2015, A4 2.0 TFSI quattro 2007>2015, A4 2.7 TDI 2007>2015, A4 3.0 TDI 2007>2015, A4 3.0 TDI quattro 2007>2015, A4 3.2 FSI 2007>2015, A4 3.2 FSI quattro 2007>2015, A4 S4 quattro 2007>2015, A4 Allroad 2.0 TDI quattro 2009>2016, A4 Allroad 2.0 TFSI quattro 2009>2016, A4 Allroad 3.0 TDI quattro 2009>2016, A4 Avant 1.8 TFSI 2007>2015, A4 Avant 1.8 TFSI quattro 2007>2015, A4 Avant 2.0 TDI 2007>2015, A4 Avant 2.0 TDI quattro 2007>2015, A4 Avant 2.0 TFSI 2007>2015, A4 Avant 2.0 TFSI flexible fuel 2007>2015, A4 Avant 2.0 TFSI flexible fuel quattro 2007>2015, A4 Avant 2.0 TFSI quattro 2007>2015, A4 Avant 2.7 TDI 2007>2015, A4 Avant 3.0 TDI 2007>2015, A4 Avant 3.0 TDI quattro 2007>2015, A4 Avant 3.0 TFSI quattro 2009>2017, A5 Convertible 3.2 FSI 2007>2015, A4 Avant 3.2 FSI quattro 2007>2015, A4 Avant RS4 quattro 2007>2015, A4 Avant S4 quattro 2007>2015, A5 1.8 TFSI 2007>2017, A5 2.0 TDI 2007>2017, A5 2.0 TDI quattro 2007>2017, A5 2.0 TFSI 2007>2017, A5 2.0 TFSI quattro 2007>2017, A5 2.7 TDI 2007>2017, A5 3.0 TDI 2007>2017, A5 3.0 TDI quattro 2007>2017, A5 3.0 TFSI quattro 2007>2017, A5 3.2 FSI 2007>2017, A5 3.2 FSI quattro 2007>2017, A5 RS5 quattro 2007>2017, A5 S5 quattro 2007>2017, A5 Convertible 1.8 TFSI 2009>2017, A5 Convertible 2.0 TDI 2009>2017, A5 Convertible 2.0 TDI quattro 2009>2017, A5 Convertible 2.0 TFSI 2009>2017, A5 Convertible 2.0 TFSI quattro 2009>2017, A5 Convertible 2.7 TDI 2009>2017, A5 Convertible 3.0 TDI 2009>2017, A5 Convertible 3.0 TDI quattro 2009>2017, A5 Convertible 3.0 TFSI quattro 2009>2017, A5 Convertible 3.2 FSI 2009>2017, A5 Convertible 3.2 FSI quattro 2009>2017, A5 Convertible RS5 quattro 2009>2017, A5 Convertible S5 quattro 2009>2017, A5 Sportback 1.8 TFSI 2009>2017, A5 Sportback 2.0 TDI 2009>2017, A5 Sportback 2.0 TDI quattro 2009>2017, A5 Sportback 2.0 TFSI 2009>2017, A5 Sportback 2.0 TFSI quattro 2009>2017, A5 Sportback 2.7 TDI 2009>2017, A5 Sportback 3.0 TDI 2009>2017, A5 Sportback 3.0 TDI quattro 2009>2017, A5 Sportback 3.0 TFSI quattro 2009>2017, A5 Sportback 3.2 FSI quattro 2009>2017, A5 Sportback S5 quattro 2009>2017, A6 1.8 T 1997>2005, A6 1.9 TDI 1997>2005, A6 2.5 TDI 1997>2005, A6 2.0 TDI 2004>2011, A6 2.0 TFSI 2004>2011, A6 2.4 2004>2011, A6 2.4 quattro 2004>2011, A6 2.7 TDI 2004>2011, A6 2.7 TDI quattro 2004>2011, A6 2.8 FSI 2004>2011, A6 2.8 FSI quattro 2004>2011, A6 3.0 2004>2011, A6 3.0 quattro 2004>2011, A6 3.0 TDI 2004>2011, A6 3.0 TFSI quattro 2004>2011, A6 3.2 FSI 2004>2011, A6 3.2 FSI quattro 2004>2011, A6 4.2 FSI quattro 2004>2011, A6 4.2 quattro 2004>2011, A6 RS6 quattro 2004>2011, A6 S6 quattro 2004>2011, A6 1.8 TFSI 2010>2018, A6 2.0 TDI 2010>2018, A6 2.0 TDI quattro 2010>2018, A6 2.0 TFSI 2010>2018, A6 2.0 TFSI hybrid 2010>2018, A6 2.0 TFSI quattro 2010>2018, A6 2.8 FSI 2010>2018, A6 2.8 FSI quattro 2010>2018, A6 3.0 TDI 2010>2018, A6 3.0 TDI quattro 2010>2018, A6 3.0 TFSI quattro 2010>2018, A6 S6 quattro 2010>2018, A6 Allroad 2.7 TDI quattro 2006>2011, A6 Allroad 3.0 TDI quattro 2006>2011, A6 Allroad 3.0 TFSI quattro 2012>2018, A6 Avant 1.8 T 1997>2005, A6 Avant 1.9 TDI 1997>2005, A6 Avant 2.5 TDI 1997>2005, A6 Avant 2.0 TDI 2004>2011, A6 Avant 2.0 TFSI 2004>2011, A6 Avant 2.4 2004>2011, A6 Avant 2.4 quattro 2004>2011, A6 Avant 2.7 TDI 2004>2011, A6 Avant 2.7 TDI quattro 2004>2011, A6 Avant 2.8 FSI 2004>2011, A6 Avant 2.8 FSI quattro 2004>2011, A6 Avant 3.0 2004>2011, A6 Avant 3.0 quattro 2004>2011, A6 Avant 3.0 TDI quattro 2004>2011, A6 Avant 3.0 TFSI quattro 2004>2011, A6 Avant 3.2 FSI 2004>2011, A6 Avant 3.2 FSI quattro 2004>2011, A6 Avant 4.2 FSI quattro 2004>2011, A6 Avant 4.2 quattro 2004>2011, A6 Avant RS6 quattro 2004>2011, A6 Avant S6 quattro 2004>2011, A6 Avant 1.8 TFSI 2011>2018, A6 Avant 2.8 FSI quattro 2011>2018, A6 Avant 3.0 TDI 2011>2018, A6 Avant 3.0 TDI quattro 2011>2018...

CONTINUE...

GS2032 // NEW //
FRONT WHEEL SENSOR (LEFT SIDE) AND REAR WHEEL SENSOR (RIGHT SIDES)

REPLACES / REEMPLAZA:
Audi: 4E0927803A, 4E0927803D, 4E0927803F, 0265007930, 0265007728; **Bosch:** 0 265 007 728, 0 265 007 930; **Cargo:** 181878; **Meat & Doria:** 90506;

Mobiletron: AB-EU139

APPLICATION / APLICACIÓN:

AUDI: A6 Avant 3.0 TFSI quattro 2011>2018, A6 Avant RS6 perparance quattro 2011>2018, A6 Avant RS6 quattro 2011>2018, A6 Avant S6 quattro 2011>2018, A7 Sportback 1.8 TFSI 2010>2018, A7 Sportback 2.0 TFSI 2010>2018, A7 Sportback 2.0 TFSI quattro 2010>2018, A7 Sportback 2.8 FSI 2010>2018, A7 Sportback 2.8 FSI quattro 2010>2018, A7 Sportback 3.0 TDI 2010>2018, A7 Sportback 3.0 TDI quattro 2010>2018, A7 Sportback 3.0 TFSI quattro 2010>2018, A7 Sportback RS7 perparance quattro 2010>2018, A7 Sportback RS7 quattro 2010>2018, A7 Sportback S7 quattro 2010>2018, A8 3.7 1995>2002, A8 3.7 quattro 1995>2002, A8 4.2 quattro 1995>2002, A8 2.8 FSI 2002>2010, A8 3.0 2002>2010, A8 3.0 quattro 2002>2010, A8 3.0 TDI quattro 2002>2010, A8 3.2 FSI 2002>2010, A8 3.2 FSI quattro 2002>2010, A8 3.7 quattro 2002>2010, A8 4.0 TDI quattro 2002>2010, A8 4.2 FSI quattro 2002>2010, A8 4.2 quattro 2002>2010, A8 4.2 TDI quattro 2002>2010, A8 6.0 W12 quattro 2002>2010, A8 S8 quattro 2002>2010, A8 2.0 TFSI hybrid 2009>2018, A8 2.0 TFSI quattro 2009>2018, A8 2.5 TFSI 2009>2018, A8 3.0 TDI 2009>2018, A8 3.0 TDI quattro 2009>2018, A8 3.0 TFSI quattro 2009>2018, A8 4.0 TFSI quattro 2009>2018, A8 4.2 FSI quattro 2009>2018, A8 4.2 TDI quattro 2009>2018, A8 6.3 W12 quattro 2009>2018, A8 S8 plus quattro 2009>2018, A8 S8 quattro 2009>2018, Q5 2.0 Hybrid quattro 2008>2017, Q5 2.0 TDI 2008>2017, Q5 2.0 TDI quattro 2008>2017, Q5 2.0 TFSI hybrid quattro 2008>2017, Q5 2.0 TFSI quattro 2008>2017, Q5 3.0 TDI quattro 2008>2017, Q5 3.0 TFSI quattro 2008>2017, Q5 3.2 FSI quattro 2008>2017, Q5 SQ5 TDI quattro 2008>2017, Q5 SQ5 TFSI quattro 2008>2017, R8 4.2 FSI quattro 2007>2015, R8 5.2 FSI quattro 2007>2015, R8 5.2 FSI quattro 2015>1900, R8 5.2 FSI RWS 2015>1900, R8 Spyder 4.2 FSI quattro 2010>2015, R8 Spyder 5.2 FSI quattro 2010>2015, R8 Spyder 5.2 FSI quattro 2016>1900, R8 Spyder 5.2 FSI RWS 2016>1900;

BENTLEY: CONTINENTAL Convertible 4.0 AWD 2006>2018, CONTINENTAL Convertible 4.0 FLEX AWD 2006>2018, CONTINENTAL Convertible 6.0 All-wheel Drive 2006>2018, CONTINENTAL Convertible 6.0 AWD 2006>2018, CONTINENTAL Convertible 6.0 CS ISR 2006>2018, CONTINENTAL Convertible 6.0 FLEX AWD 2006>2018, CONTINENTAL Coupe 4.0 2003>2018, CONTINENTAL Coupe 4.0 FLEX 2003>2018, CONTINENTAL Coupe 4.0 GT 2003>2018, CONTINENTAL Coupe 6.0 2003>2018, CONTINENTAL Coupe 6.0 AWD 2003>2018, CONTINENTAL Coupe 6.0 FLEX 2003>2018, CONTINENTAL Coupe 6.0 Supersports AWD 2003>2018, CONTINENTAL FLYING SPUR 6.0 2005>2013, CONTINENTAL FLYING SPUR 6.0 FLEX 2005>2013, FLYING SPUR 4.0 2013>1900, FLYING SPUR 4.0 FLEX 2013>1900, FLYING SPUR 6.0 2013>1900, FLYING SPUR 6.0 FLEX 2013>1900, FLYING SPUR V8 S 6.0 2013>1900, FLYING SPUR W12 S 6.0 2013>1900, MULSANNE 6.8 2009>1900;

VW: PHAETON 3.0 V6 TDI 4motion 2002>2016, PHAETON 3.2 V6 2002>2016, PHAETON 3.2 V6 4motion 2002>2016, PHAETON 3.6 V6 4motion 2002>2016, PHAETON 4.2 V8 4motion 2002>2016, PHAETON 5.0 V10 TDI 4motion 2002>2016, PHAETON 6.0 W12 4motion 2002>2016

GS2033 // NEW //
FRONT WHEEL SENSOR (RIGHT SIDE) AND rear wheel SENSOR (LEFT SIDES)

REPLACES / REEMPLAZA:
Audi: 4E0927804A, 4E0927804D, 4E0927804F, 0265007928, 0265007726, 0265007406; **Bosch:** 0 265 007 726, 0 265 007 928; **Cargo:** 182297; **Meat & Doria:** 90507; **Mobiletron:** AB-EU140

APPLICATION / APLICACIÓN:

BMW: 3 316 i 1997>2005, 3 318 d 1997>2005, 3 318 i 1997>2005, 3 320 d 1997>2005, 3 320 i 1997>2005, 3 323 i 1997>2005, 3 325 i 1997>2005, 3 330 d 1997>2005, 3 330 i 1997>2005, 3 Compact 316 ti 2001>2005, 3 Compact 318 td 2001>2005, 3 Compact 318 ti 2001>2005, 3 Compact 320 td 2001>2005, 3 Compact 325 ti 2001>2005, 3 Convertible 318 Ci 2000>2007, 3 Convertible 320 Cd 2000>2007, 3 Convertible 320 Ci 2000>2007, 3 Convertible 325 Ci 2000>2007, 3 Convertible 330 Cd 2000>2007, 3 Convertible 330 Ci 2000>2007, 3 Convertible M3 2000>2007, 3 Coupe 316 Ci 1998>2006, 3 Coupe 318 Ci 1998>2006, 3 Coupe 320 Cd 1998>2006, 3 Coupe 320 Ci 1998>2006, 3 Coupe 325 Ci 1998>2006, 3 Coupe 330 Cd 1998>2006, 3 Coupe 330 Ci 1998>2006, 3 Coupe M3 1998>2006, 3 Touring 316 i 1999>2005, 3 Touring 318 d 1999>2005, 3 Touring 318 i 1999>2005, 3 Touring 320 d 1999>2005, 3 Touring 320 i 1999>2005, 3 Touring 325 i 1999>2005, 3 Touring 330 d 1999>2005, 3 Touring 330 i 1999>2005, Z4 Coupe 3.0 si 2006>2009, Z4 Coupe M 2006>2009, Z4 Roadster 2.0 i 2002>2009, Z4 Roadster 2.2 i 2002>2009, Z4 Roadster 2.5 si 2002>2009, Z4 Roadster 3.0 i 2002>2009, Z4 Roadster 3.0 si 2002>2009, Z4 Roadster M 2002>2009;

BMW BRIL: 3 SERIES 318 i 2004>2005;

PORSCHE: 918 Spyder 4.6 2013>1900;

AUDI: A4 1.8 TFSI 2007>2015, A4 1.8 TFSI quattro 2007>2015, A4 2.0 TDI 2007>2015, A4 2.0 TDI quattro 2007>2015, A4 2.0 TFSI 2007>2015, A4 2.0 TFSI flexible fuel 2007>2015, A4 2.0 TFSI flexible fuel quattro 2007>2015, A4 2.7 TDI 2007>2015, A4 3.0 TDI 2007>2015, A4 3.0 TDI quattro 2007>2015, A4 3.0 TFSI 2007>2015, A4 3.2 FSI 2007>2015, A4 3.2 FSI quattro 2007>2015, A4 S4 quattro 2007>2015, A4 Allroad 2.0 TDI quattro 2009>2016, A4 Allroad 2.0 TFSI quattro 2009>2016, A4 Allroad 3.0 TDI quattro 2009>2016, A4 Avant 1.8 TFSI 2007>2015, A4 Avant 1.8 TFSI quattro 2007>2015, A4 Avant 2.0 TDI 2007>2015, A4 Avant 2.0 TDI quattro 2007>2015, A4 Avant 2.0 TFSI 2007>2015, A4 Avant 2.0 TFSI flexible fuel 2007>2015, A4 Avant 2.0 TFSI flexible fuel quattro 2007>2015, A4 Avant 2.0 TFSI quattro 2007>2015, A4 Avant 2.7 TDI 2007>2015, A4 Avant 3.0 TDI 2007>2015, A4 Avant 3.0 TDI quattro 2007>2015, A4 Avant 3.0 TFSI quattro 2007>2015, A4 Avant 3.2 FSI 2007>2015, A4 Avant 3.2 FSI quattro 2007>2015, A4 Avant RS4 quattro 2007>2015, A4 Avant S4 quattro 2007>2015, A5 1.8 TFSI 2007>2017, A5 2.0 TDI 2007>2017, A5 2.0 TDI quattro 2007>2017, A5 2.0 TFSI 2007>2017, A5 2.0 TFSI quattro 2007>2017, A5 2.0 TFSI quattro 2009>2017, A5 2.0 TFSI quattro 2012>2018, A5 3.0 TDI 2009>2017, A5 3.0 TDI quattro 2009>2017, A5 3.0 TFSI 2009>2017, A5 3.0 TFSI quattro 2009>2017, A5 3.2 FSI 2007>2017, A5 3.2 FSI quattro 2007>2017, A5 RS5 quattro 2007>2017, A5 S5 quattro 2007>2017, A5 Convertible 1.8 TFSI 2009>2017, A5 Convertible 2.0 TDI 2009>2017, A5 Convertible 2.0 TDI quattro 2009>2017, A5 Convertible 2.0 TFSI 2009>2017, A5 Convertible 2.0 TFSI quattro 2009>2017, A5 Convertible 2.7 TDI 2009>2017, A5 Convertible 3.0 TDI 2009>2017, A5 Convertible 3.0 TDI quattro 2009>2017, A5 Convertible 3.0 TFSI 2009>2017, A5 Convertible 3.2 FSI 2009>2017, A5 Convertible 3.2 FSI quattro 2009>2017, A5 Convertible RS5 quattro 2009>2017, A5 Sportback 1.8 TFSI 2009>2017, A5 Sportback 2.0 TDI 2009>2017, A5 Sportback 2.0 TDI quattro 2009>2017, A5 Sportback 2.0 TFSI 2009>2017, A5 Sportback 2.0 TFSI quattro 2009>2017, A5 Sportback 2.7 TDI 2009>2017, A5 Sportback 3.0 TDI 2009>2017, A5 Sportback 3.0 TDI quattro 2009>2017, A5 Sportback 3.0 TFSI quattro 2009>2017, A5 Sportback 3.2 FSI quattro 2009>2017, A5 Sportback S5 quattro 2009>2017, A6 1.8 T 1997>2005, A6 1.9 TDI 1997>2005, A6 2.5 TDI 1997>2005, A6 2.0 TDI 2004>2011, A6 2.0 TFSI 2004>2011, A6 2.4 2004>2011, A6 2.4 quattro 2004>2011, A6 2.7 TDI 2004>2011, A6 2.7 TDI quattro 2004>2011, A6 2.8 FSI 2004>2011, A6 2.8 FSI quattro 2004>2011, A6 3.0 2004>2011, A6 3.0 quattro 2004>2011, A6 3.0 TDI quattro 2004>2011, A6 3.0 TFSI quattro 2004>2011, A6 3.2 FSI 2004>2011, A6 3.2 FSI quattro 2004>2011, A6 4.2 FSI quattro 2004>2011, A6 4.2 quattro 2004>2011, A6 4.2 TDI 2010>2018, A6 2.0 TDI 2010>2018, A6 2.0 TFSI 2010>2018, A6 2.0 TFSI hybrid 2010>2018, A6 2.0 TFSI quattro 2010>2018, A6 2.8 FSI 2010>2018, A6 2.8 FSI quattro 2010>2018, A6 3.0 TDI 2010>2018, A6 3.0 TDI quattro 2010>2018, A6 3.0 TFSI quattro 2010>2018, A6 S6 quattro 2010>2018, A6 Allroad 2.7 TDI quattro 2006>2011, A6 Allroad 3.0 TDI quattro 2006>2011, A6 Allroad 3.0 TFSI quattro 2006>2011, A6 Allroad 4.2 FSI quattro 2006>2011, A6 Allroad 3.0 TDI quattro 2012>2018, A6 Allroad 3.0 TFSI quattro 2012>2018, A6 Avant 1.8 T 1997>2005, A6 Avant 1.9 TDI 1997>2005, A6 Avant 2.5 TDI 1997>2005, A6 Avant 2.0 TDI 2004>2011, A6 Avant 2.0 TFSI 2004>2011, A6 Avant 2.4 2004>2011, A6 Avant 2.4 quattro 2004>2011, A6 Avant 2.7 TDI 2004>2011, A6 Avant 2.7 TDI quattro 2004>2011, A6 Avant 2.8 FSI 2004>2011, A6 Avant 2.8 FSI quattro 2004>2011, A6 Avant 3.0 2004>2011, A6 Avant 3.0 quattro 2004>2011, A6 Avant 3.0 TDI quattro 2004>2011, A6 Avant 3.0 TFSI quattro 2004>2011, A6 Avant 3.2 FSI 2004>2011, A6 Avant 3.2 FSI quattro 2004>2011, A6 Avant 4.2 FSI quattro 2004>2011, A6 Avant 4.2 quattro 2004>2011, A6 Avant RS6 quattro 2004>2011, A6 Avant S6 quattro 2004>2011, A6 Avant 1.8 TFSI 2011>2018, A6 Avant 2.0 TDI 2011>2018, A6 Avant 2.0 TDI quattro 2011>2018, A6 Avant 2.0 TFSI 2011>2018, A6 Avant 2.0 TFSI quattro 2011>2018, A6 Avant 2.8 FSI 2011>2018, A6 Avant 2.8 FSI quattro 2011>2018, A6 Avant 3.0 TDI 2011>2018, A6 Avant 3.0 TDI quattro 2011>2018, A6 Avant 3.0 TFSI quattro 2011>2018, A6 Avant RS6 perparance quattro 2011>2018, A6 Avant RS6 quattro 2011>2018, A6 Avant S6 quattro 2011>2018, A7 Sportback 1.8 TFSI 2010>2018, A7 Sportback 2.0 TFSI 2010>2018, A7 Sportback 2.0 TFSI quattro 2010>2018, A7 Sportback 2.8 FSI 2010>2018, A7 Sportback 2.8 FSI quattro 2010>2018, A7 Sportback 3.0 TDI 2010>2018, A7 Sportback 3.0 TDI quattro 2010>2018, A7 Sportback 3.0 TFSI quattro 2010>2018, A7 Sportback RS7 perparance quattro 2010>2018, A7 Sportback RS7 quattro 2010>2018, A7 Sportback S7 quattro 2010>2018, A8 3.7 1995>2002, A8 3.7 quattro 1995>2002, A8 4.2 quattro 1995>2002, A8 2.8 FSI 2002>2010, A8 3.0 2002>2010, A8 3.0 quattro 2002>2010, A8 3.0 TDI quattro 2002>2010, A8 3.2 FSI 2002>2010, A8 3.2 FSI quattro 2002>2010, A8 3.7 quattro 2002>2010, A8 4.0 TDI quattro 2002>2010, A8 4.2 FSI quattro 2002>2010, A8 4.2 quattro 2002>2010, A8 4.2 TDI quattro 2002>2010, A8 6.0 W12 quattro 2002>2010, A8 S8 quattro 2002>2010, A8 2.0 TFSI hybrid 2009>2018, A8 2.0 TFSI quattro 2009>2018, A8 2.5 TFSI 2009>2018, A8 3.0 TDI 2009>2018, A8 3.0 TDI quattro 2009>2018, A8 3.0 TFSI quattro 2009>2018, A8 4.0 TFSI quattro 2009>2018, A8 4.2 FSI quattro 2009>2018, A8 4.2 TDI quattro 2009>2018, A8 6.3 W12 quattro 2009>2018, A8 S8 plus quattro 2009>2018, A8 S8 quattro 2009>2018, Q5 2.0 Hybrid quattro 2008>2017, Q5 2.0 TDI 2008>2017, Q5 2.0 TDI quattro 2008>2017...

CONTINUE...



GS2033 // NEW //

FRONT WHEEL SENSOR (RIGHT SIDE) AND rear wheel SENSOR (LEFT SIDES)

REPLACES / REEMPLAZA:

Audi: 4E0927804A, 4E0927804D, 4E0927804F, 0265007928, 0265007726, 0265007406; **Bosch:** 0 265 007 726, 0 265 007 928; **Cargo:** 182297; **Meat & Doria:** 90507; **Mobiletron:** AB-EU140

APPLICATION / APLICACIÓN:

AUDI: Q5 2.0 TFSI hybrid quattro 2008>2017, Q5 2.0 TFSI quattro 2008>2017, Q5 3.0 TDI quattro 2008>2017, Q5 3.0 TFSI quattro 2008>2017, Q5 3.2 FSI quattro 2008>2017, Q5 SQ5 TDI quattro 2008>2017, Q5 SQ5 TFSI quattro 2008>2017, R8 4.2 FSI quattro 2007>2015, R8 5.2 FSI quattro 2007>2015, R8 5.2 FSI quattro 2015>1900, R8 5.2 FSI RWS 2015>1900, R8 Spyder 4.2 FSI quattro 2010>2015, R8 Spyder 5.2 FSI quattro 2010>2015, R8 Spyder 5.2 FSI quattro 2016>1900, R8 Spyder 5.2 FSI RWS 2016>1900;

BENTLEY: CONTINENTAL Convertible 4.0 AWD 2006>2018, CONTINENTAL Convertible 4.0 FLEX AWD 2006>2018, CONTINENTAL Convertible 6.0 All-wheel Drive 2006>2018, CONTINENTAL Convertible 6.0 AWD 2006>2018, CONTINENTAL Convertible 6.0 CS ISR 2006>2018, CONTINENTAL Convertible 6.0 FLEX AWD 2006>2018, CONTINENTAL Coupe 4.0 2003>2018, CONTINENTAL Coupe 4.0 FLEX 2003>2018, CONTINENTAL Coupe 4.0 GT 2003>2018, CONTINENTAL Coupe 6.0 2003>2018, CONTINENTAL Coupe 6.0 AWD 2003>2018, CONTINENTAL Coupe 6.0 FLEX 2003>2018, CONTINENTAL Coupe 6.0 Supersports AWD 2003>2018, CONTINENTAL FLYING SPUR 6.0 2005>2013, CONTINENTAL FLYING SPUR 6.0 FLEX 2005>2013, FLYING SPUR 4.0 2013>1900, FLYING SPUR 4.0 FLEX 2013>1900, FLYING SPUR 6.0 2013>1900, FLYING SPUR 6.0 FLEX 2013>1900, FLYING SPUR V8 S 4.0 2013>1900, FLYING SPUR W12 S 6.0 2013>1900, MULSANNE 6.8 2009>1900;

VW: PHAETON 3.0 V6 TDI 4motion 2002>2016, PHAETON 3.2 V6 2002>2016, PHAETON 3.2 V6 4motion 2002>2016, PHAETON 3.6 V6 4motion 2002>2016, PHAETON 4.2 V8 4motion 2002>2016, PHAETON 5.0 V10 TDI 4motion 2002>2016, PHAETON 6.0 W12 4motion 2002>2016



GS2034 // NEW //

FRONT WHEEL SENSOR (BOTH SIDES)

REPLACES / REEMPLAZA:

BMW: 34526756375, 34520025723, 34521165534, 0986594508; **Bosch:** 0 986 594 508; **Delphi:** SS20007;

Cargo: 181864; **Meat & Doria:** 90004; **Mobiletron:** AB-EU053

APPLICATION / APLICACIÓN:

BMW: 5 520 d 1995>2003, 5 520 i 1995>2003, 5 523 i 1995>2003, 5 525 d 1995>2003, 5 525 i 1995>2003, 5 525 td 1995>2003, 5 525 tds 1995>2003, 5 528 i 1995>2003, 5 530 d 1995>2003, 5 530 i 1995>2003, 5 535 i 1995>2003, 5 540 i 1995>2003, 5 M5 1995>2003, 5 Touring 520 d 1996>2004, 5 Touring 520 i 1996>2004, 5 Touring 523 i 1996>2004, 5 Touring 525 d 1996>2004, 5 Touring 525 i 1996>2004, 5 Touring 525 tds 1996>2004, 5 Touring 528 i 1996>2004, 5 Touring 530 d 1996>2004, 5 Touring 530 i 1996>2004, 5 Touring 540 i 1996>2004



GS2035 // NEW //

REAR WHEEL SENSOR (BOTH SIDES)

REPLACES / REEMPLAZA:

BMW: 34526756377, 34521165535, 34520025720, 34520025724, 34526756376, 34521165536, 0986594512;

Bosch: 0 986 594 512; **Delphi:** SS20009; **Meat & Doria:** 90006; **Mobiletron:** AB-EU083

APPLICATION / APLICACIÓN:

BMW: 5 540 i 1995>2003, 5 Touring 520 d 1996>2004, 5 Touring 520 i 1996>2004, 5 Touring 523 i 1996>2004, 5 Touring 525 d 1996>2004, 5 Touring 525 i 1996>2004, 5 Touring 525 tds 1996>2004, 5 Touring 528 i 1996>2004, 5 Touring 530 d 1996>2004, 5 Touring 530 i 1996>2004, 5 Touring 540 i 1996>2004



GS2036 // NEW //

REAR WHEEL SENSOR (BOTH SIDES)

REPLACES / REEMPLAZA:

BMW: 34526762466, 0986594514, 0986594571, 34526760425, 34526785021, 34526870076; **Bosch:** 0 986 594 514; **Delphi:** SS20160; **Meat & Doria:** 90142;

Mobiletron: AB-EU067

APPLICATION / APLICACIÓN:

BMW: 1 116 d 2006>2012, 1 116 i 2006>2012, 1 118 d 2006>2012, 1 118 i 2006>2012, 1 120 d 2006>2012, 1 120 i 2006>2012, 1 116 d 2004>2012, 1 116 i 2004>2012, 1 118 d 2004>2012, 1 118 i 2004>2012, 1 120 d 2004>2012, 1 120 i 2004>2012, 1 Convertible 118 d 2007>2013, 1 Convertible 118 i 2007>2013, 1 Convertible 120 d 2007>2013, 1 Convertible 120 i 2007>2013, 1 Coupe 118 d 2007>2013, 1 Coupe 120 d 2007>2013, 1 Coupe 120 i 2007>2013, 3 316 d 2004>2011, 3 316 i 2004>2011, 3 318 d 2004>2011, 3 318 i 2004>2011, 3 320 d 2004>2011, 3 320 i 2004>2011, 3 Convertible 318 i 2006>2013, 3 Convertible 320 i 2006>2013, 3 Coupe 316 i 2006>2013, 3 Coupe 318 i 2006>2013, 3 Coupe 320 d 2006>2013, 3 Coupe 320 i 2006>2013, 3 Touring 316 d 2004>2012, 3 Touring 316 i 2004>2012, 3 Touring 318 d 2004>2012, 3 Touring 318 i 2004>2012, 3 Touring 320 d 2004>2012, 3 Touring 320 i 2004>2012, 1 123 d 2006>2012, 1 123 d 2004>2012, 3 316 i 1997>2005, 3 320 d xDrive 2004>2011, 3 325 i 2004>2011, 3 Coupe 316 Ci 1998>2006, 3 Coupe 320 d xDrive 2006>2013, 3 Touring 320 d xDrive 2004>2012



GS2037 // NEW //

FRONT WHEEL SENSOR (BOTH SIDES)

REPLACES / REEMPLAZA:

BMW: 34526762465; **Bosch:** 0 986 594 519; **Delphi:** SS20216; **Meat & Doria:** 90143, 90143E; **Mobiletron:** AB-EU316

APPLICATION / APLICACIÓN:

BMW: 1 116 D 2008>0, 1 116 I 2004>0, 1 118 D 2004>0, 1 118 I 2004>0, 1 120 D 2004>0, 1 120 I 2004>0, 1 123 D 2007>0, 1 Convertible 118 D 2004>0, 1 Convertible 118 I 2004>0, 1 Convertible 120 D 2004>0, 1 Convertible 120 I 2004>0, 1 Convertible 123 D 2007>0, 1 Coupe 118 D 2004>0, 1 Coupe 120 D 2004>0, 1 Coupe 120 I 2004>0, 1 Coupe 123 D 2007>0, 3 316 D 2009>0, 3 316 I 2005>0, 3 318 D 2005>0, 3 318 I 2005>0, 3 320 D 2004>0, 3 320 I 2004>0, 3 320 Si 2005>0, 3 Convertible 318 I 2005>0, 3 Convertible 320 D 2004>0, 3 Convertible 320 I 2004>0, 3 Coupe 316 I 2005>0, 3 Coupe 318 I 2005>0, 3 Coupe 320 D 2004>0, 3 Coupe 320 I 2004>0, 3 Touring 316 D 2009>0, 3 Touring 316 I 2005>0, 3 Touring 318 D 2005>0, 3 Touring 318 I 2005>0, 3 Touring 320 D 2004>0, 3 Touring 320 I 2004>0



GS2038 // NEW //

FRONT WHEEL SENSOR (BOTH SIDES)

REPLACES / REEMPLAZA:

BMW: 34523405906, 34523420330; **Bosch:** 0 986 594 570; **Delphi:** SS20547; **Meat & Doria:** 90044; **Mobiletron:** AB-EU302

APPLICATION / APLICACIÓN:

BMW: X3 2.0 D 2004>2007, X3 2.0 I 2005>2008, X3 2.5 I 2004>2006, X3 2.5 Si 2006>2008, X3 2.5 Si xDrive 2006>2008, X3 3.0 D 2004>2005, X3 3.0 I xDrive 2003>2006, X3 3.0 Sd 2006>2008, X3 3.0 Si 2006>2008, X3 xDrive 18 D 2008>2011, X3 xDrive 20 D 2008>2010, X3 xDrive 20 I 2008>2011, X3 xDrive 25 I 2008>2010, X3 xDrive 30 D 2008>2010, X3 xDrive 30 I 2008>2010, X3 xDrive 35 D 2008>2011



GS2039 // NEW //

REAR WHEEL SENSOR (BOTH SIDES)

REPLACES / REEMPLAZA:

BMW: 34523405907, 34523420331; **Bosch:** 0 265 007 622, 0 265 007 855; **Cargo:** 182301; **Mobiletron:** AB-EU414

APPLICATION / APLICACIÓN:

BMW: X3 2.0 d 2003>2011, X3 2.5 i 2003>2011, X3 3.0 d 2003>2011, X3 3.0 i xDrive 2003>2011, X3 2.0 i 2003>2011, X3 2.5 si 2003>2011, X3 2.5 si xDrive 2003>2011, X3 3.0 sd 2003>2011, X3 3.0 si 2003>2011, X3 xDrive 18 d 2003>2011, X3 xDrive 20 d 2003>2011, X3 xDrive 20 i 2003>2011, X3 xDrive 25 i 2003>2011, X3 xDrive 30 d 2003>2011, X3 xDrive 30 i 2003>2011, X3 xDrive 35 d 2003>2011

GS2040 // NEW //
FRONT WHEEL SENSOR (BOTH SIDES)

REPLACES / REEMPLAZA:

BMW: 34526771702, 34526760045, 0265007848, 0265009591, 0986594574; **Bosch:** 34526771702; **Delphi:** SS20072; **Meat & Doria:** 90287; **Mobiletron:** AB-EU457

APPLICATION / APLICACIÓN:

BMW: 5 520 d 2001>2010, 5 520 i 2001>2010, 5 523 i 2001>2010, 5 525 d 2001>2010, 5 525 d xDrive 2001>2010, 5 525 i 2001>2010, 5 525 i xDrive 2001>2010, 5 525 xd 2001>2010, 5 525 xi 2001>2010, 5 530 d 2001>2010, 5 530 d xDrive 2001>2010, 5 530 i 2001>2010, 5 530 i xDrive 2001>2010, 5 530 xd 2001>2010, 5 530 xi 2001>2010, 5 535 d 2001>2010, 5 535 i 2001>2010, 5 540 i 2001>2010, 5 545 i 2001>2010, 5 550 i 2001>2010, 5 M5 2001>2010, 5 Touring 520 d 2004>2010, 5 Touring 520 i 2004>2010, 5 Touring 523 i 2004>2010, 5 Touring 525 d 2004>2010, 5 Touring 525 d xDrive 2004>2010, 5 Touring 525 i 2004>2010, 5 Touring 525 i xDrive 2004>2010, 5 Touring 525 xd 2004>2010, 5 Touring 525 xi 2004>2010, 5 Touring 530 d 2004>2010, 5 Touring 530 d xDrive 2004>2010, 5 Touring 530 i 2004>2010, 5 Touring 530 i xDrive 2004>2010, 5 Touring 530 xd 2004>2010, 5 Touring 530 xi 2004>2010, 5 Touring 535 d 2004>2010, 5 Touring 545 i 2004>2010, 5 Touring 550 i 2004>2010, 5 Touring M5 2004>2010, 6 630 i 2003>2010, 6 635 d 2003>2010, 6 645 Ci 2003>2010, 6 650 i 2003>2010, 6 M 2003>2010, 6 Convertible 630 i 2004>2010, 6 Convertible 635 d 2004>2010, 6 Convertible 645 Ci 2004>2010, 6 Convertible 650 i 2004>2010, 6 Convertible M 2004>2010

GS2041 // NEW //
REAR WHEEL SENSOR (BOTH SIDES)

REPLACES / REEMPLAZA:

BMW: 34526760046, 34526771703, 0265007849; **Delphi:** SS20071; **Meat & Doria:** 90288; **Mobiletron:** AB-EU194

APPLICATION / APLICACIÓN:

BMW: 5 520 d 2001>2010, 5 520 i 2001>2010, 5 523 i 2001>2010, 5 525 d 2001>2010, 5 525 d xDrive 2001>2010, 5 525 i 2001>2010, 5 525 i xDrive 2001>2010, 5 525 xd 2001>2010, 5 525 xi 2001>2010, 5 530 d 2001>2010, 5 530 d xDrive 2001>2010, 5 530 i 2001>2010, 5 530 i xDrive 2001>2010, 5 530 xd 2001>2010, 5 530 xi 2001>2010, 5 535 d 2001>2010, 5 535 i 2001>2010, 5 540 i 2001>2010, 5 545 i 2001>2010, 5 550 i 2001>2010, 5 M5 2001>2010, 5 Touring 520 d 2004>2010, 5 Touring 520 i 2004>2010, 5 Touring 523 i 2004>2010, 5 Touring 525 d 2004>2010, 5 Touring 525 d xDrive 2004>2010, 5 Touring 525 i 2004>2010, 5 Touring 525 i xDrive 2004>2010, 5 Touring 525 xd 2004>2010, 5 Touring 525 xi 2004>2010, 5 Touring 530 d 2004>2010, 5 Touring 530 d xDrive 2004>2010, 5 Touring 530 i 2004>2010, 5 Touring 530 i xDrive 2004>2010, 5 Touring 530 xd 2004>2010, 5 Touring 530 xi 2004>2010, 5 Touring 535 d 2004>2010, 5 Touring 545 i 2004>2010, 5 Touring 550 i 2004>2010, 5 Touring M5 2004>2010, 6 630 i 2003>2010, 6 645 Ci 2003>2010, 6 650 i 2003>2010, 6 M 2003>2010, 6 Convertible 630 i 2004>2010, 6 Convertible 635 d 2004>2010, 6 Convertible 645 Ci 2004>2010, 6 Convertible 650 i 2004>2010, 6 Convertible M 2004>2010

GS2042
REAR WHEEL SENSOR

REPLACES / REEMPLAZA:

Renault: 8200675755
Opel: 04419128, 4419128, 93859337

APPLICATION / APLICACIÓN:

Renault: Traffic Bus/Box
Opel: Vivaro Minibus/Van

GS2043 // NEW //
REAR WHEEL SENSOR (BOTH SIDES)

REPLACES / REEMPLAZA:

BMW: 34526771777; **Bosch:** 0 986 594 627; **Meat & Doria:** 90627; **Mobiletron:** B-EU441

APPLICATION / APLICACIÓN:

BMW: X5 3.0 D 2007>0, X5 3.0 Sd 2007>0, X5 3.0 Si 2006>0, X5 4.8 I Xdrive 2006>0, X5 M 2009>0, X5 M 50 D 2011>0, X5 Xdrive 30 D 2008>0, X5 Xdrive 30 I 2007>0, X5 Xdrive 35 D 2008>0, X5 Xdrive 35 I 2007>0, X5 Xdrive 40 D 2009>0, X5 Xdrive 48 I 2008>0, X5 Xdrive 50 I 2007>0, X5 Sdrive 25 D 2013>0, X5 Xdrive 25 D 2013>0, X5 Xdrive 40E 2015>0, X6 Activehybrid 2009>0, X6 Activehybrid Xdrive 2009>0, X6 M 2009>0, X6 M 50 D 2011>0, X6 Xdrive 30 D 2008>0, X6 Xdrive 35 D 2008>0, X6 Xdrive 35 I 2007>0, X6 Xdrive 40 D 2009>0, X6 Xdrive 50 I 2007>0

GS2044 // NEW //
FRONT WHEEL SENSOR (BOTH SIDES)

REPLACES / REEMPLAZA:

BMW: 34526771776; **Bosch:** 0 986 594 626; **Meat & Doria:** 90626

APPLICATION / APLICACIÓN:

BMW: X5 3.0 D 2007>0, X5 3.0 Sd 2007>0, X5 3.0 Si 2006>0, X5 4.8 I Xdrive 2006>0, X5 M 2009>0, X5 M 50 D 2011>0, X5 Xdrive 30 D 2008>0, X5 Xdrive 30 I 2007>0, X5 Xdrive 35 D 2008>0, X5 Xdrive 35 I 2007>0, X5 Xdrive 40 D 2009>0, X5 Xdrive 48 I 2008>0, X5 Xdrive 50 I 2007>0, X5 Sdrive 25 D 2013>0, X5 Xdrive 25 D 2013>0, X5 Xdrive 40E 2015>0, X6 Activehybrid 2009>0, X6 Activehybrid Xdrive 2009>0, X6 M 2009>0, X6 M 50 D 2011>0, X6 Xdrive 30 D 2008>0, X6 Xdrive 35 D 2008>0, X6 Xdrive 35 I 2007>0, X6 Xdrive 40 D 2009>0, X6 Xdrive 50 I 2007>0

GS2045 // NEW //
FRONT WHEEL SENSOR (BOTH SIDES)

REPLACES / REEMPLAZA:

BMW: 34526775863, 34526782099, 34526853859, 0265009227, 0265007981; **Bosch:** 0 265 007 981, 0 265 009 227; **Delphi:** SS20324; **Meat & Doria:** 90865, 90865E; **Mobiletron:** AB-EU300

APPLICATION / APLICACIÓN:

BMW: 5 518 d 2009>2016, 5 520 d 2009>2016, 5 523 i 2009>2016, 5 525 d 2009>2016, 5 528 i 2009>2016, 5 530 d 2009>2016, 5 530 i 2009>2016, 5 535 d 2009>2016, 5 535 i 2009>2016, 5 550 i 2009>2016, 5 ActiveHybrid 2009>2016, 5 M5 2009>2016, 5 M5 Competition 2009>2016, 5 M5 Edition 30 2009>2016, 5 Gran Turismo 520 d 2009>2017, 5 Gran Turismo 528 i 2009>2017, 5 Gran Turismo 530 d 2009>2017, 5 Gran Turismo 535 d 2009>2017, 5 Gran Turismo 535 i 2009>2017, 5 Gran Turismo 550 i 2009>2017, 5 Touring 518 d 2009>2017, 5 Touring 520 d 2009>2017, 5 Touring 520 i 2009>2017, 5 Touring 525 d 2009>2017, 5 Touring 528 i 2009>2017, 5 Touring 530 d 2009>2017, 5 Touring 530 i 2009>2017, 5 Touring 535 d 2009>2017, 5 Touring 535 i 2009>2017, 5 Touring 550 i 2009>2017, 6 Convertible 640 d 2010>2018, 6 Convertible 650 i 2010>2018, 6 Convertible M6 2010>2018, 6 Convertible M6 Competition 2010>2018, 6 Coupe 640 d 2011>2017, 6 Coupe 640 i 2011>2017, 6 Coupe 650 i 2011>2017, 6 Coupe M6 2011>2017, 6 Coupe M6 Competition 2011>2017, 6 Gran Coupe 640 d 2012>2018, 6 Gran Coupe 640 i 2012>2018, 6 Gran Coupe 650 i 2012>2018, 6 Gran Coupe M6 2012>2018, 6 Gran Coupe M6 Competition 2012>2018, 7 730 d 2008>2015, 7 730 i, Li 2008>2015, 7 740 d 2008>2015, 7 740 i, Li 2008>2015, 7 750 i 2008>2015, 7 750 i, Li 2008>2015, 7 760 i 2008>2015, 7 ActiveHybrid 2008>2015, 5 520 d xDrive 2009>2016, 5 525 d xDrive 2009>2016, 5 528 i xDrive 2009>2016, 5 530 d xDrive 2009>2016, 5 535 d xDrive 2009>2016, 5 535 i xDrive 2009>2016, 5 550 i xDrive 2009>2016, 5 M 550 d xDrive 2009>2016, 5 Gran Turismo 530 d xDrive 2009>2017, 5 Gran Turismo 535 d xDrive 2009>2017, 5 Gran Turismo 535 i xDrive 2009>2017, 5 Gran Turismo 550 i xDrive 2009>2017, 5 Touring 520 d xDrive 2009>2017, 5 Touring 523 i 2009>2017, 5 Touring 525 d xDrive 2009>2017, 5 Touring 528 i xDrive 2009>2017, 5 Touring 530 d xDrive 2009>2017, 5 Touring 535 d xDrive 2009>2017, 5 Touring M 550 d xDrive 2009>2017, 6 Convertible 640 d xDrive 2010>2018, 6 Convertible 640 i xDrive 2010>2018, 6 Convertible 650 i xDrive 2010>2018, 6 Coupe 640 d xDrive 2011>2017, 6 Coupe 640 i xDrive 2011>2017, 6 Coupe 650 i xDrive 2011>2017, 6 Gran Coupe 640 d xDrive 2012>2018, 6 Gran Coupe 640 i xDrive 2012>2018, 6 Gran Coupe M6 2012>2018, 6 Gran Coupe M6 Competition 2012>2018, 7 730 d xDrive 2008>2015, 7 740 d xDrive 2008>2015, 7 740 i, Li xDrive 2008>2015, 7 750 d xDrive 2008>2015, 7 750 i, Li xDrive 2008>2015;

ROLLS-ROYCE: DAWN 6.6 2016>1900, DAWN 6.6 Black Badge 2016>1900, GHOST V12 2009>2014, GHOST V-Specification 2009>2014, WRAITH V12 2013>1900;
ALPINA: B7 BITURBO 2009>2012, B7 BITURBO All-wheel Drive 2009>2012



GS2046 // NEW //

REAR WHEEL SENSOR (BOTH SIDES)

REPLACES / REEMPLAZA:

BMW: 34526775866, 0265008036, 34526775864, 0265007983; **Bosch:** 0 265 008 036; **Mobiletron:** AB-EU301

APPLICATION / APLICACIÓN:

BMW: 5 Gran Turismo 520 d 2009>2017, 5 Gran Turismo 528 i 2009>2017, 5 Gran Turismo 530 d 2009>2017, 5 Gran Turismo 530 d xDrive 2009>2017, 5 Gran Turismo 535 d 2009>2017, 5 Gran Turismo 535 d xDrive 2009>2017, 5 Gran Turismo 535 i 2009>2017, 5 Gran Turismo 535 i xDrive 2009>2017, 5 Gran Turismo 550 i 2009>2017, 5 Gran Turismo 550 i xDrive 2009>2017, 5 Touring 518 d 2009>2017, 5 Touring 520 d 2009>2017, 5 Touring 520 d xDrive 2009>2017, 5 Touring 520 i 2009>2017, 5 Touring 523 i 2009>2017, 5 Touring 525 d 2009>2017, 5 Touring 525 d xDrive 2009>2017, 5 Touring 528 i 2009>2017, 5 Touring 528 i xDrive 2009>2017, 5 Touring 530 d 2009>2017, 5 Touring 530 d xDrive 2009>2017, 5 Touring 530 i 2009>2017, 5 Touring 535 d 2009>2017, 5 Touring 535 d xDrive 2009>2017, 5 Touring 535 i 2009>2017, 5 Touring 535 i xDrive 2009>2017, 5 Touring 550 i 2009>2017, 5 Touring M 550 d xDrive 2009>2017



GS2047 // NEW //

REAR WHEEL SENSOR (BOTH SIDES)

REPLACES / REEMPLAZA:

BMW: 34526785022, 34526762476, 34526870077, 0986594572; **Bosch:** 0 986 594 572; **Delphi:** SS20222; **Meat & Doria:** 90146, 90146E; **Mobiletron:** AB-EU197

APPLICATION / APLICACIÓN:

BMW: 1 123 d 2006>2012, 1 130 i 2006>2012, 1 123 d 2004>2012, 1 130 i 2004>2012, 1 Convertible 123 d 2007>2013, 1 Convertible 135 i 2007>2013, 1 Coupe 123 d 2007>2013, 1 Coupe 135 i 2007>2013, 1 Coupe M 2007>2013, 3 325 d 2004>2011, 3 325 i 2004>2011, 3 330 d 2004>2011, 3 330 i 2004>2011, 3 335 d 2004>2011, 3 335 i 2004>2011, 3 335 i xDrive 2004>2011, 3 M3 2004>2011, 3 335 i 2011>2018, 3 Convertible 320 d 2006>2013, 3 Convertible 320 i 2006>2013, 3 Convertible 323 i 2006>2013, 3 Convertible 325 d 2006>2013, 3 Convertible 325 i 2006>2013, 3 Convertible 330 d 2006>2013, 3 Convertible 330 i 2006>2013, 3 Convertible 335 i 2006>2013, 3 Convertible M3 2006>2013, 3 Coupe 320 i 2006>2013, 3 Coupe 325 d 2006>2013, 3 Coupe 325 i 2006>2013, 3 Coupe 330 d 2006>2013, 3 Coupe 330 i 2006>2013, 3 Coupe 335 i 2006>2013, 3 Coupe 335 i xDrive 2006>2013, 3 Coupe M3 2006>2013, 3 Touring 320 d 2004>2012, 3 Touring 320 i 2004>2012, 3 Touring 323 i 2004>2012, 3 Touring 325 d 2004>2012, 3 Touring 325 i 2004>2012, 3 Touring 330 d 2004>2012, 3 Touring 330 i 2004>2012, 3 Touring 335 d 2004>2012, 3 Touring 335 i 2004>2012, 3 320 d 2004>2011, 3 323 i 2004>2011, 3 335 xi 2004>2011, 3 M3 CRT 2004>2011, 3 Coupe 320 d 2006>2013, 3 Coupe 320 d xDrive 2006>2013, 3 Coupe 323 i 2006>2013, 3 Coupe 325 i 2006>2013, 3 Coupe M GTS 2006>2013, 3 Touring 335 i xDrive 2004>2012, 3 Touring 335 xi 2004>2012



GS2048 // NEW //

FRONT WHEEL SENSOR (BOTH SIDES)

REPLACES / REEMPLAZA:

BMW: 34526780424, 34526785020, 34526870075, 0986594540; **Bosch:** 0 986 594 540; **Delphi:** SS20162; **Meat & Doria:** 90141, 90141E; **Mobiletron:** AB-EU192

APPLICATION / APLICACIÓN:

BMW: 1 120 d 2006>2012, 1 120 i 2006>2012, 1 123 d 2006>2012, 1 130 i 2006>2012, 1 120 d 2004>2012, 1 120 i 2004>2012, 1 123 d 2004>2012, 1 130 i 2004>2012, 1 Convertible 120 d 2007>2013, 1 Convertible 120 i 2007>2013, 1 Convertible 123 d 2007>2013, 1 Convertible 125 i 2007>2013, 1 Convertible 128 i 2007>2013, 1 Convertible 135 i 2007>2013, 1 Coupe 120 d 2007>2013, 1 Coupe 123 d 2007>2013, 1 Coupe 125 i 2007>2013, 1 Coupe 135 i 2007>2013, 3 320 d 2004>2011, 3 320 i 2004>2011, 3 323 i 2004>2011, 3 325 d 2004>2011, 3 325 i 2004>2011, 3 328 i 2004>2011, 3 330 d 2004>2011, 3 330 i 2004>2011, 3 335 d 2004>2011, 3 335 i 2004>2011, 3 335 i xDrive 2004>2011, 3 Convertible 320 d 2006>2013, 3 Convertible 320 i 2006>2013, 3 Convertible 323 i 2006>2013, 3 Convertible 325 d 2006>2013, 3 Convertible 325 i 2006>2013, 3 Convertible 330 d 2006>2013, 3 Convertible 330 i 2006>2013, 3 Coupe 320 d 2006>2013, 3 Coupe 320 i 2006>2013, 3 Coupe 323 i 2006>2013, 3 Coupe 325 d 2006>2013, 3 Coupe 325 i 2006>2013, 3 Coupe 328 i 2006>2013, 3 Coupe 330 d 2006>2013, 3 Coupe 330 i 2006>2013, 3 Coupe 335 d 2006>2013, 3 Coupe 335 i 2006>2013, 3 Coupe 335 i xDrive 2006>2013, 3 Touring 320 d 2004>2012, 3 Touring 320 i 2004>2012, 3 Touring 323 i 2004>2012, 3 Touring 325 d 2004>2012, 3 Touring 325 i 2004>2012, 3 Touring 330 d 2004>2012, 3 Touring 330 i 2004>2012, 3 Touring 335 d 2004>2012, 3 Touring 335 i 2004>2012, 1 Coupe 118 d 2007>2013, 1 Coupe 120 i 2007>2013, 3 335 xi 2004>2011, 3 Convertible 318 i 2006>2013, 3 Coupe 320 d xDrive 2006>2013, 3 Coupe 325 i xDrive 2006>2013, 3 Coupe 325 xi 2006>2013, 3 Touring 320 d xDrive 2004>2012, 3 Touring 325 i xDrive 2004>2012, 3 Touring 325 xi 2004>2012, 3 Touring 330 i xDrive 2004>2012, 3 Touring 335 i xDrive 2004>2012, 3 Touring 335 xi 2004>2012, VAUXHALL: CorsaVan Mk III 1.3 CDTI 2006>1900, FORD: Focus II Saloon 2.0 TDCi 2005>2013



GS2049 // NEW //

FRONT WHEEL SENSOR (BOTH SIDES)

REPLACES / REEMPLAZA:

BMW: 34526791223, 34526791224, 34526869320; **Meat & Doria:** 90638, 90638E

APPLICATION / APLICACIÓN:

BMW: 1 114 d 2011>2019, 1 114 i 2011>2019, 1 116 d 2011>2019, 1 116 i 2011>2019, 1 118 d 2011>2019, 1 118 i 2011>2019, 1 120 d 2011>2019, 1 120 i 2011>2019, 1 125 d 2011>2019, 1 125 i 2011>2019, 1 M 135 i 2011>2019, 1 114 d 2011>1900, 1 114 i 2011>1900, 1 116 d 2011>1900, 1 116 i 2011>1900, 1 118 d 2011>1900, 1 118 i 2011>1900, 1 120 d 2011>1900, 1 120 i 2011>1900, 1 125 d 2011>1900, 1 125 i 2011>1900, 1 M 135 i 2011>1900, 2 Convertible 218 d 2014>2016, 2 Convertible 218 i 2014>2016, 2 Convertible 220 d 2014>2016, 2 Convertible 220 i 2014>2016, 2 Convertible 225 d 2014>2016, 2 Convertible 228 i 2014>2016, 2 Convertible M 235 i 2014>2016, 2 Coupe 218 d 2012>2018, 2 Coupe 218 i 2012>2018, 2 Coupe 220 d 2012>2018, 2 Coupe 220 i 2012>2018, 2 Coupe 225 d 2012>2018, 2 Coupe 228 i 2012>2018, 2 Coupe M 235 i 2012>2018, 3 316 d 2011>2018, 3 316 i 2011>2018, 3 318 d 2011>2018, 3 318 i 2011>2018, 3 320 d 2011>2018, 3 320 i 2011>2018, 3 325 d 2011>2018, 3 328 i 2011>2018, 3 330 d 2011>2018, 3 330 e 2011>2018, 3 330 i 2011>2018, 3 335 i 2011>2018, 3 340 i 2011>2018, 3 ActiveHybrid 2011>2018, 3 Touring 316 d 2012>2019, 3 Touring 316 i 2012>2019, 3 Touring 318 d 2012>2019, 3 Touring 318 i 2012>2019, 3 Touring 320 d 2012>2019, 3 Touring 320 i 2012>2019, 3 Touring 325 d 2012>2019, 3 Touring 328 i 2012>2019, 3 Touring 330 d 2012>2019, 3 Touring 330 i 2012>2019, 3 Touring 335 i 2012>2019, 3 Touring 340 i 2012>2019, 4 Convertible 420 d 2013>2018, 4 Convertible 420 i 2013>2018, 4 Convertible 425 d 2013>2018, 4 Convertible 428 i 2013>2018, 4 Convertible 430 d 2013>2018, 4 Convertible 430 i 2013>2018, 4 Convertible 435 i 2013>2018, 4 Convertible 440 i 2013>2018, 4 Coupe 418 d 2013>2019, 4 Coupe 418 i 2013>2019, 4 Coupe 420 d 2013>2019, 4 Coupe 420 i 2013>2019, 4 Coupe 425 d 2013>2019, 4 Coupe 428 i 2013>2019, 4 Coupe 430 d 2013>2019, 4 Coupe 430 i 2013>2019, 4 Coupe 435 i 2013>2019, 4 Coupe 440 i 2013>2019, 4 Gran Coupe 418 d 2014>2018, 4 Gran Coupe 418 i 2014>2018, 4 Gran Coupe 420 d 2014>2018, 4 Gran Coupe 420 i 2014>2018, 4 Gran Coupe 425 d 2014>2018, 4 Gran Coupe 428 i 2014>2018, 4 Gran Coupe 430 i 2014>2018, 4 Gran Coupe 435 i 2014>2018, 4 Gran Coupe 440 i 2014>2018

GS2050 // NEW //
REAR WHEEL SENSOR (BOTH SIDES)
REPLACES / REEMPLAZA:
BMW: 34526791225; **Bosch:** 0 986 594 612; **Meat & Doria:** 90642; **Mobiletron:** AB-EU277

APPLICATION / APLICACIÓN:

BMW: 1 114 d 2011>2019, 1 114 i 2011>2019, 1 116 d 2011>2019, 1 116 i 2011>2019, 1 118 d 2011>2019, 1 118 i 2011>2019, 1 120 d 2011>2019, 1 120 d xDrive 2011>2019, 1 120 i 2011>2019, 1 125 d 2011>2019, 1 125 i 2011>2019, 1 125 i Active Flex 2011>2019, 1 M 135 i 2011>2019, 1 M 135 i xDrive 2011>2019, 1 M 140 i 2011>2019, 1 M 140 i xDrive 2011>2019, 1 114 d 2011>1900, 1 114 i 2011>1900, 1 116 d 2011>1900, 1 116 i 2011>1900, 1 118 d 2011>1900, 1 118 i 2011>1900, 1 120 d 2011>1900, 1 120 d xDrive 2011>1900, 1 120 i 2011>1900, 1 125 d 2011>1900, 1 125 i 2011>1900, 1 125 i Active Flex 2011>1900, 1 M 135 i 2011>1900, 1 M 135 i xDrive 2011>1900, 1 M 140 i 2011>1900, 1 M 140 i xDrive 2011>1900, 1 Van 118 d 2015>2019, 1 Van 118 i 2015>2019, 1 Van 120 d 2015>2019, 1 Van 120 i 2015>2019, 1 Van M 140 i 2015>2019, 2 Convertible 218 d 2014>2016, 2 Convertible 218 i 2014>2016, 2 Convertible 220 d 2014>2016, 2 Convertible 220 i 2014>2016, 2 Convertible 225 d 2014>2016, 2 Convertible 228 i 2014>2016, 2 Convertible 230 i 2014>2016, 2 Convertible M 235 i 2014>2016, 2 Convertible M 235 i xDrive 2014>2016, 2 Convertible M 240 i 2014>2016, 2 Convertible M 240 i xDrive 2014>2016, 2 Coupe 218 d 2012>2018, 2 Coupe 218 i 2012>2018, 2 Coupe 220 d 2012>2018, 2 Coupe 220 i 2012>2018, 2 Coupe 225 d 2012>2018, 2 Coupe 228 i 2012>2018, 2 Coupe 230 i 2012>2018, 2 Coupe M 235 i 2012>2018, 2 Coupe M 235 i xDrive 2012>2018, 2 Coupe M 240 i 2012>2018, 2 Coupe M 240 i xDrive 2012>2018, 3 316 d 2011>2018, 3 316 i 2011>2018, 3 318 d 2011>2018, 3 318 i 2011>2018, 3 318 i 2011>2018, 3 320 d 2011>2018, 3 320 d xDrive 2011>2018, 3 320 i 2011>2018, 3 320 i ActiveFlex 2011>2018, 3 320 i xDrive 2011>2018, 3 325 d 2011>2018, 3 325 i 2011>2018, 3 328 i 2011>2018, 3 328 i ActiveFlex 2011>2018, 3 328 i xDrive 2011>2018, 3 328 i xDrive 2011>2018, 3 330 d 2011>2018, 3 330 d xDrive 2011>2018, 3 330 e 2011>2018, 3 330 e 2011>2018, 3 330 i 2011>2018, 3 330 i xDrive 2011>2018, 3 335 d xDrive 2011>2018, 3 335 i 2011>2018, 3 335 i xDrive 2011>2018, 3 340 i 2011>2018, 3 340 i xDrive 2011>2018, 3 ActiveHybrid 2011>2018, 3 Gran Turismo 318 d 2012>2016, 3 Gran Turismo 320 d 2012>2016, 3 Gran Turismo 320 d xDrive 2012>2016, 3 Gran Turismo 320 i 2012>2016, 3 Gran Turismo 320 i xDrive 2012>2016, 3 Gran Turismo 325 d 2012>2016, 3 Gran Turismo 328 i 2012>2016, 3 Gran Turismo 328 i xDrive 2012>2016, 3 Gran Turismo 330 d 2012>2016, 3 Gran Turismo 330 d xDrive 2012>2016, 3 Gran Turismo 330 i 2012>2016, 3 Gran Turismo 330 i xDrive 2012>2016, 3 Gran Turismo 335 d xDrive 2012>2016, 3 Gran Turismo 335 i 2012>2016, 3 Gran Turismo 335 i xDrive 2012>2016, 3 Gran Turismo 340 i 2012>2016, 3 Gran Turismo 340 i xDrive 2012>2016, 3 Touring 316 d 2012>2019, 3 Touring 316 i 2012>2019, 3 Touring 318 d 2012>2019, 3 Touring 318 d xDrive 2012>2019, 3 Touring 318 i 2012>2019, 3 Touring 320 d 2012>2019, 3 Touring 320 d xDrive 2012>2019, 3 Touring 320 i 2012>2019, 3 Touring 320 i xDrive 2012>2019, 3 Touring 328 i 2012>2019, 3 Touring 328 i xDrive 2012>2019, 3 Touring 330 d 2012>2019, 3 Touring 330 d xDrive 2012>2019, 3 Touring 330 i 2012>2019, 3 Touring 330 i xDrive 2012>2019, 3 Touring 335 d xDrive 2012>2019, 3 Touring 335 i 2012>2019, 3 Touring 335 i xDrive 2012>2019, 3 Touring 340 i 2012>2019, 3 Touring 340 i xDrive 2012>2019, 3 Touring Van 330 d 2012>2019, 3 Touring Van 330 d xDrive 2012>2019, 3 Touring Van 330 i 2012>2019, 3 Touring Van 330 i xDrive 2012>2019, 3 Touring Van 340 i 2012>2019, 4 Convertible 420 d 2013>2018, 4 Convertible 420 i 2013>2018, 4 Convertible 425 d 2013>2018, 4 Convertible 428 i 2013>2018, 4 Convertible 428 i xDrive 2013>2018, 4 Convertible 430 d 2013>2018, 4 Convertible 430 i 2013>2018, 4 Convertible 430 i xDrive 2013>2018, 4 Convertible 435 d 2013>2018, 4 Convertible 435 i 2013>2018, 4 Convertible 435 i xDrive 2013>2018, 4 Convertible 440 i 2013>2018, 4 Convertible 440 i xDrive 2013>2018, 4 Coupe 418 i 2013>2019, 4 Coupe 420 d 2013>2019, 4 Coupe 420 d xDrive 2013>2019, 4 Coupe 420 i 2013>2019, 4 Coupe 420 i xDrive 2013>2019, 4 Coupe 425 d 2013>2019, 4 Coupe 428 i 2013>2019, 4 Coupe 428 i xDrive 2013>2019, 4 Coupe 430 d 2013>2019, 4 Coupe 430 d xDrive 2013>2019, 4 Coupe 430 i 2013>2019, 4 Coupe 430 i xDrive 2013>2019, 4 Coupe 435 d 2013>2019, 4 Coupe 435 d xDrive 2013>2019, 4 Coupe 435 i 2013>2019, 4 Coupe 435 i xDrive 2013>2019, 4 Coupe 440 i 2013>2019, 4 Coupe 440 i xDrive 2013>2019, 4 Gran Coupe 418 d 2014>2018, 4 Gran Coupe 418 i 2014>2018, 4 Gran Coupe 420 d 2014>2018, 4 Gran Coupe 420 d xDrive 2014>2018, 4 Gran Coupe 420 i 2014>2018, 4 Gran Coupe 420 i xDrive 2014>2018, 4 Gran Coupe 425 d 2014>2018, 4 Gran Coupe 425 d xDrive 2014>2018, 4 Gran Coupe 428 i 2014>2018, 4 Gran Coupe 428 i xDrive 2014>2018, 4 Gran Coupe 430 d 2014>2018, 4 Gran Coupe 430 d xDrive 2014>2018, 4 Gran Coupe 430 i 2014>2018, 4 Gran Coupe 430 i xDrive 2014>2018, 4 Gran Coupe 435 d 2014>2018, 4 Gran Coupe 435 d xDrive 2014>2018, 4 Gran Coupe 435 i 2014>2018, 4 Gran Coupe 435 i xDrive 2014>2018, 4 Gran Coupe 440 i 2014>2018, 4 Gran Coupe 440 i xDrive 2014>2018, 2 Coupe M2 2012>2018, 2 Coupe M2 Competition 2012>2018, 3 M3 2011>2018, 3 M3 Competition 2011>2018, 3 M3 CS 2011>2018, 4 Convertible M4 2013>2018, 4 Convertible M4 Competition 2013>2018, 4 Coupe 418 d 2013>2019, 4 Coupe M4 2013>2019, 4 Coupe M4 Competition 2013>2019, 4 Coupe M4 CS 2013>2019, 4 Coupe M4 GTS 2013>2019

GS2051 // NEW //
FRONT WHEEL SENSOR (BOTH SIDES)
REPLACES / REEMPLAZA:
BMW: 34521163027, 0986594015; **Bosch:** 0 986 594 015; **Delphi:** SS20005; **Meat & Doria:** 90051; **Mobiletron:** AB-EU022

APPLICATION / APLICACIÓN:

BMW: 3 316 i 1990>1998, 3 318 i 1990>1998, 3 318 i 1990>1998, 3 318 tds 1990>1998, 3 320 i 1990>1998, 3 323 i 1990>1998, 3 325 i 1990>1998, 3 325 td 1990>1998, 3 325 tds 1990>1998, 3 328 i 1990>1998, 3 M3 3.0 1990>1998, 3 M3 3.2 1990>1998, 3 323 i 1997>2005, 3 Compact 316 g 1994>2000, 3 Compact 316 i 1994>2000, 3 Compact 318 tds 1994>2000, 3 Compact 318 ti 1994>2000, 3 Compact 323 ti 1994>2000, 3 Convertible 318 i 1993>1999, 3 Convertible 318 is 1993>1999, 3 Convertible 320 i 1993>1999, 3 Convertible 323 i 1993>1999, 3 Convertible 325 i 1993>1999, 3 Convertible 328 i 1993>1999, 3 Convertible M3 3.0 1993>1999, 3 Convertible M3 3.2 1993>1999, 3 Coupe 316 i 1991>1999, 3 Coupe 318 is 1991>1999, 3 Coupe 320 i 1991>1999, 3 Coupe 323 i 1991>1999, 3 Coupe 325 i 1991>1999, 3 Coupe 325 is 1991>1999, 3 Coupe 328 i 1991>1999, 3 Coupe M3 3.0 1991>1999, 3 Coupe M3 3.2 1991>1999, 3 Touring 316 i 1995>1999, 3 Touring 318 i 1995>1999, 3 Touring 318 tds 1995>1999, 3 Touring 320 i 1995>1999, 3 Touring 323 i 1995>1999, 3 Touring 325 tds 1995>1999, 3 Touring 328 i 1995>1999, 3 Touring 328 i 1995>1999, 3 Z3 Coupe 2.8 i 1997>2003, 3 Z3 Coupe 3.0 i 1997>2003, 3 Z3 Coupe M 1997>2003, 3 Z3 Coupe M 3.2 1997>2003, 3 Z3 Roadster 1.8 i 1995>2003, 3 Z3 Roadster 1.9 i 1995>2003, 3 Z3 Roadster 2.0 i 1995>2003, 3 Z3 Roadster 2.2 i 1995>2003, 3 Z3 Roadster 2.8 i 1995>2003, 3 Z3 Roadster 3.0 i 1995>2003, 3 Z3 Roadster M 3.2 1995>2003

GS2052 // NEW //
REAR WHEEL SENSOR (BOTH SIDES)
REPLACES / REEMPLAZA:
BMW: 34521163028, 34521181126, 34521182063, 34521182067, 34521163028, 0986594016; **Bosch:** 0 986 594 016; **Delphi:** SS20006; **Meat & Doria:** 90075; **Mobiletron:** AB-EU054

APPLICATION / APLICACIÓN:

BMW: 3 316 i 1990>1998, 3 318 i 1990>1998, 3 318 tds 1990>1998, 3 320 i 1990>1998, 3 323 i 1990>1998, 3 325 i 1990>1998, 3 325 td 1990>1998, 3 325 tds 1990>1998, 3 328 i 1990>1998, 3 M3 3.0 1990>1998, 3 M3 3.2 1990>1998, 3 323 i 1997>2005, 3 Convertible 318 i 1988>1992, 3 Convertible 318 i 1993>1999, 3 Convertible 318 is 1993>1999, 3 Convertible 320 i 1993>1999, 3 Convertible 323 i 1993>1999, 3 Convertible 325 i 1993>1999, 3 Convertible 328 i 1993>1999, 3 Convertible M3 3.0 1993>1999, 3 Convertible M3 3.2 1993>1999, 3 Coupe 316 i 1991>1999, 3 Coupe 318 is 1991>1999, 3 Coupe 320 i 1991>1999, 3 Coupe 323 i 1991>1999, 3 Coupe 325 i 1991>1999, 3 Coupe 325 is 1991>1999, 3 Coupe 328 i 1991>1999, 3 Coupe M3 3.0 1991>1999, 3 Coupe M3 3.2 1991>1999, 3 Touring 316 i 1995>1999, 3 Touring 318 i 1995>1999, 3 Touring 318 tds 1995>1999, 3 Touring 320 i 1995>1999, 3 Touring 323 i 1995>1999, 3 Touring 325 tds 1995>1999, 3 Touring 328 i 1995>1999, 3 Compact 316 g 1994>2000, 3 Compact 316 i 1994>2000, 3 Compact 318 tds 1994>2000, 3 Compact 318 ti 1994>2000, 3 Compact 323 ti 1994>2000

GS2053 // NEW //
FRONT WHEEL SENSOR (BOTH SIDES)
REPLACES / REEMPLAZA:
BMW: 34526764858, 0265007669; **Delphi:** SS20555; **Mobiletron:** AB-EU461

APPLICATION / APLICACIÓN:
BMW: 3 320 d xDrive 2004>2011, 3 325 i xDrive 2004>2011, 3 325 xi 2004>2011, 3 328 i xDrive 2004>2011, 3 328 xi 2004>2011, 3 330 d xDrive 2004>2011, 3 330 i xDrive 2004>2011, 3 330 xd 2004>2011, 3 330 xi 2004>2011, 3 335 i xDrive 2004>2011, 3 335 xi 2004>2011, 3 Coupe 320 d xDrive 2006>2013, 3 Coupe 325 i xDrive 2006>2013, 3 Coupe 325 xi 2006>2013, 3 Coupe 328 i xDrive 2006>2013, 3 Coupe 328 xi 2006>2013, 3 Coupe 330 d 2006>2013, 3 Coupe 330 d xDrive 2006>2013, 3 Coupe 330 i 2006>2013, 3 Coupe 330 i xDrive 2006>2013, 3 Coupe 330 xd 2006>2013, 3 Coupe 330 xi 2006>2013, 3 Coupe 335 i 2006>2013, 3 Coupe 335 i xDrive 2006>2013, 3 Coupe 335 xi 2006>2013, 3 Touring 320 d xDrive 2004>2012, 3 Touring 325 i xDrive 2004>2012, 3 Touring 325 xi 2004>2012, 3 Touring 328 i xDrive 2004>2012, 3 Touring 328 xi 2004>2012, 3 Touring 330 d xDrive 2004>2012, 3 Touring 330 i xDrive 2004>2012, 3 Touring 330 xd 2004>2012, 3 Touring 330 xi 2004>2012, 3 Touring 335 i xDrive 2004>2012, 3 Touring 335 xi 2004>2012

GS2054 // NEW //
REAR WHEEL SENSOR (BOTH SIDES)
REPLACES / REEMPLAZA:
BMW: 34526764859, 0265007670, 0265009595, 0986594575; **Bosch:** 0 986 594 575; **Delphi:** SS20556; **Mobiletron:** AB-EU460

APPLICATION / APLICACIÓN:
BMW: 3 320 d xDrive 2004>2011, 3 325 i xDrive 2004>2011, 3 325 xi 2004>2011, 3 330 d xDrive 2004>2011, 3 330 i xDrive 2004>2011, 3 330 xd 2004>2011, 3 330 xi 2004>2011, 3 335 i xDrive 2004>2011, 3 335 xi 2004>2011, 3 335 i xDrive 2011>2018, 3 Coupe 320 d xDrive 2006>2013, 3 Coupe 325 i xDrive 2006>2013, 3 Coupe 325 xi 2006>2013, 3 Coupe 330 d xDrive 2006>2013, 3 Coupe 330 i xDrive 2006>2013, 3 Coupe 330 xd 2006>2013, 3 Coupe 330 xi 2006>2013, 3 Coupe 335 i xDrive 2006>2013, 3 Coupe 335 xi 2006>2013, 3 Touring 320 d xDrive 2004>2012, 3 Touring 325 i xDrive 2004>2012, 3 Touring 325 xi 2004>2012, 3 Touring 330 d xDrive 2004>2012, 3 Touring 330 i xDrive 2004>2012, 3 Touring 330 xd 2004>2012, 3 Touring 330 xi 2004>2012, 3 Touring 335 i xDrive 2004>2012, 3 Touring 335 xi 2004>2012, 3 328 i xDrive 2004>2011, 3 328 xi 2004>2011, 3 Coupe 328 i xDrive 2006>2013, 3 Coupe 328 xi 2006>2013, 3 Touring 328 i xDrive 2004>2012, 3 Touring 328 xi 2004>2012

GS2055 // NEW //
FRONT WHEEL SENSOR (BOTH SIDES)
REPLACES / REEMPLAZA:
BMW: 34521182159, 0986594510; **Bosch:** 0 986 594 510; **Delphi:** SS10305; **Meat & Doria:** 90089; **Mobiletron:** AB-EU116

APPLICATION / APLICACIÓN:
BMW: 5 520 i 1995>2003, 5 523 i 1995>2003, 5 525 td 1995>2003, 5 525 tds 1995>2003, 5 528 i 1995>2003, 5 535 i 1995>2003, 5 540 i 1995>2003, 5 Touring 520 i 1996>2004, 5 Touring 523 i 1996>2004, 5 Touring 525 tds 1996>2004, 5 Touring 528 i 1996>2004, 5 Touring 540 i 1996>2004, 5 530 d 1995>2003, 5 Touring 530 d 1996>2004

GS2056 // NEW //
REAR WHEEL SENSOR (BOTH SIDES)
REPLACES / REEMPLAZA:
BMW: 34521182160, 0986594511; **Bosch:** 0 986 594 511; **Delphi:** SS10306; **Meat & Doria:** 90010; **Mobiletron:** AB-EU078

APPLICATION / APLICACIÓN:
BMW: 5 520 i 1995>2003, 5 523 i 1995>2003, 5 525 td 1995>2003, 5 525 tds 1995>2003, 5 528 i 1995>2003, 5 535 i 1995>2003, 5 540 i 1995>2003, 5 Touring 528 i 1996>2004, 5 Touring 540 i 1996>2004, 5 530 d 1995>2003

GS2057 // NEW //
FRONT WHEEL SENSOR (BOTH SIDES)
REPLACES / REEMPLAZA:
BMW: 34526869292; **Meat & Doria:** 90648

APPLICATION / APLICACIÓN:
BMW: X3 sDrive 18 d 2010>2017, X3 sDrive 20 i 2010>2017, X3 xDrive 20 d 2010>2017, X3 xDrive 20 i 2010>2017, X3 xDrive 28 i 2010>2017, X3 xDrive 30 d 2010>2017, X3 xDrive 35 d 2010>2017, X3 xDrive 35 i 2010>2017, X4 M 40 i 2014>2018, X4 xDrive 20 d 2014>2018, X4 xDrive 20 i 2014>2018, X4 xDrive 28 i 2014>2018, X4 xDrive 30 d 2014>2018, X4 xDrive 35 d 2014>2018, X4 xDrive 35 i 2014>2018

GS2058 // NEW //
REAR WHEEL SENSOR (BOTH SIDES)
REPLACES / REEMPLAZA:
BMW: 34526869293; **Bosch:** 0 986 594 631; **Meat & Doria:** 90649

APPLICATION / APLICACIÓN:
BMW: X3 Sdrive 18 D 2012>0, X3 Sdrive 20 i 2014>0, X3 Xdrive 20 D 2010>0, X3 Xdrive 20 i 2011>0, X3 Xdrive 28 i 2011>0, X3 Xdrive 30 D 2011>0, X3 Xdrive 35 D 2011>0, X3 Xdrive 35 i 2010>0, X4 M 40 i 2015>0, X4 Xdrive 20 D 2010>0, X4 Xdrive 20 i 2011>0, X4 Xdrive 28 i 2011>0, X4 Xdrive 30 D 2011>0, X4 Xdrive 35 D 2011>0, X4 Xdrive 35 i 2010>0

GS2059 // NEW //
FRONT WHEEL SENSOR (BOTH SIDES)
REPLACES / REEMPLAZA:
BMW: 34526784991, 0265008240, 0265009596

APPLICATION / APLICACIÓN:
BMW: X1 Xdrive 18 D 2009>0, X1 Xdrive 20 D 2009>0, X1 Xdrive 20 i 2011>0, X1 Xdrive 23 D 2009>0, X1 Xdrive 25 D 2009>0, X1 Xdrive 25 i 2010>0, X1 Xdrive 28 i 2009>0, X1 Xdrive 28 i Flex 2011>0

GS2060 // NEW //
REAR WHEEL SENSOR (BOTH SIDES)
REPLACES / REEMPLAZA:
BMW: 34526789111, 0265008238

APPLICATION / APLICACIÓN:
BMW: X1 Sdrive 16 D 2012>0, X1 Sdrive 16 i 2013>0, X1 Sdrive 18 D 2009>0, X1 Sdrive 18 i 2010>0, X1 Sdrive 20 D 2009>0, X1 Sdrive 20 i 2011>0, X1 Xdrive 18 D 2009>0, X1 Xdrive 20 D 2009>0, X1 Xdrive 20 i 2011>0, X1 Xdrive 23 D 2009>0, X1 Xdrive 25 D 2009>0, X1 Xdrive 25 i 2010>0, X1 Xdrive 28 i 2009>0, X1 Xdrive 28 i Flex 2011>0



GS2061 // NEW //
REAR WHEEL SENSOR (BOTH SIDES)
REPLACES / REEMPLAZA:
Ford: 4485165, 56028188AB, F37Z2L373A, F3TZ2L373A, F85Z2L373A, F85Z9E731AB, ZZL043711, ZZL143711, ZZP043711, ZZP043711A, ZZP043711B, ZZP043711C;

Mobiletron: AB-US006

APPLICATION / APLICACIÓN:
CHRYSLER: Dodge Jeep Dakota 1990>1997, Ram 1500 Pic 1994>1997, Ram 2500 Pic 1994>1997, Ram 3500 Pic 1994>1997, Ram 3500 Van 1997>;

FORD: Ranger 4x2 1998>2012, F250 4x2/ 4x4 1997>1999

GS2062 // NEW //
REAR WHEEL SENSOR (BOTH SIDES)
REPLACES / REEMPLAZA:
Citroën: 454598, 0986594552; **Bosch:** 0 986 594 552; **Delphi:** SS20134; **Meat & Doria:** 90150; **Mobiletron:** AB-EU095

APPLICATION / APLICACIÓN:
PEUGEOT: 1007 1.4 2005>1900, 1007 1.4 16V 2005>1900, 1007 1.4 HDi 2005>1900, 1007 1.6 16V 2005>1900, 1007 1.6 HDi 2005>1900;

CITROËN: C2 1.1 2003>2009, C2 1.4 2003>2009, C2 1.4 16V 2003>2009, C2 1.4 HDi 2003>2009, C2 1.6 2003>2009, C2 1.6 HDi 2003>2009, C2 1.6 VTS 2003>2009, C2 ENTERPRISE 1.1 2003>2008, C2 ENTERPRISE 1.4 HDi 2003>2008, C3 I 1.1 i 2002>2012, C3 I 1.1 LPG 2002>2012, C3 I 1.4 2002>2012, C3 I 1.4 16V 2002>2012, C3 I 1.4 16V HDi 2002>2012, C3 I 1.4 BiFuel 2002>2012, C3 I 1.4 Flex 2002>2012, C3 I 1.4 HDi 2002>2012, C3 I 1.4 i 2002>2012, C3 I 1.4 i Bivalent 2002>2012, C3 I 1.6 16V 2002>2012, C3 I 1.6 16V HDi 2002>2012, C3 I 1.6 Bioflex 2002>2012, C3 Pluriel 1.4 2003>1900, C3 Pluriel 1.4 HDi 2003>1900, C3 Pluriel 1.6 2003>1900, C3 II 1.1 i 2009>2016, C3 II 1.4 2009>2016, C3 II 1.4 HDi 70 2009>2016, C3 II 1.4 LPG 2009>2016, C3 II 1.4 VTI 95 2009>2016, C3 II 1.6 HDi 2009>2016, C3 II 1.6 HDi 110 2009>2016, C3 II 1.6 HDi 115 2009>2016, C3 II 1.6 HDi 90 2009>2016, C3 II 1.6 VTI 120 2009>2016, C3 Picasso 1.4 VTI 95 2009>2016, C3 Picasso 1.4 VTI 95 LPG 2009>2016, C3 Picasso 1.6 HDi 2009>2016, C3 Picasso 1.6 HDi 110 2009>2016, C3 Picasso 1.6 HDi 115 2009>2016, C3 Picasso 1.6 HDi 90 2009>2016, C3 Picasso 1.6 VTI 120 2009>2016

GS2063 // NEW //
FRONT WHEEL SENSOR (BOTH SIDES)
REPLACES / REEMPLAZA:
Peugeot: 4545C1, 9635384780, 9652310580, 0986594559, 0265009482, 4545K3, 4545F5/9665386780; **Bosch:** 0 986 594 559; **Delphi:** SS20132; **Cargo:** 182306; **Meat & Doria:** 90085; **Mobiletron:** AB-EU073

APPLICATION / APLICACIÓN:
PEUGEOT: 307 1.4 2000>2012, 307 1.4 16V 2000>2012, 307 1.4 HDi 2000>2012, 307 1.6 2000>2012, 307 1.6 16V 2000>2012, 307 1.6 HDi 2000>2012, 307 1.6 HDi 110 2000>2012, 307 2.0 2000>2012, 307 2.0 16V 2000>2012, 307 2.0 HDi 110 2000>2012, 307 2.0 HDi 135 2000>2012, 307 2.0 HDi 90 2000>2012, 307 Break 1.4 2002>2009, 307 Break 1.4 16V 2002>2009, 307 Break 1.4 HDi 2002>2009, 307 Break 1.6 16V 2002>2009, 307 Break 1.6 HDi 2002>2009, 307 Break 1.6 HDi 110 2002>2009, 307 Break 2.0 2002>2009, 307 Break 2.0 16V 2002>2009, 307 Break 2.0 HDi 110 2002>2009, 307 Break 2.0 HDi 135 2002>2009, 307 Break 2.0 HDi 90 2002>2009, 307 CC 1.6 16V 2003>2009, 307 CC 2.0 16V 2003>2009, 307 CC 2.0 HDi 135 2003>2009, 307 Saloon 2.0 2004>2012, 307 SW 1.4 2002>2009, 307 SW 1.4 16V 2002>2009, 307 SW 1.6 16V 2002>2009, 307 SW 1.6 HDi 110 2002>2009, 307 SW 1.6 HDi 110 2002>2009, 307 SW 2.0 HDi 135 2002>2009, 307 SW 2.0 HDi 90 2002>2009, 307 SW Box Body/Estate 1.4 HDi 2002>2009, 307 SW Box Body/Estate 2.0 HDi 2002>2009, 307 1.6 BioFlex 2000>2012, 307 1.6 Flex 2000>2012, 307 SW 1.6 HDi 90 2002>2009, 307 SW Box Body/Estate 1.6 HDi 2002>2009;

CITROËN: C4 Coupe 1.4 16V 2004>2011, C4 Coupe 1.6 16V 2004>2011, C4 Coupe 1.6 HDi 2004>2011, C4 Coupe 1.6 THP 150 2004>2011, C4 Coupe 1.6 VTI 120 2004>2011, C4 Coupe 2.0 16V 2004>2011, C4 Coupe 2.0 HDi 2004>2011, C4 Coupe 2.0 VTR 2004>2011, C4 I 1.4 16V 2004>2011, C4 I 1.6 16V 2004>2011, C4 I 1.6 HDi 2004>2011, C4 I 1.6 THP 140 2004>2011, C4 I 1.6 THP 150 2004>2011, C4 I 1.6 VTI 120 2004>2011, C4 I 2.0 16V 2004>2011, C4 I 2.0 HDi 2004>2011, C4 I Box Body / Hatchback 2.0 HDi 2005>2010, C4 I Saloon 1.6 16V 2006>2011, C4 I Saloon 1.6 HDi 2006>2011, C4 I Saloon 2.0 16V 2006>2011, C4 I Saloon 2.0 HDi 2006>2011, C4 Coupe 1.6 THP 2004>2011, C4 Grand Picasso I 1.6 16V 2006>2013, C4 Grand Picasso I 1.6 HDi 2006>2013, C4 Grand Picasso I 1.6 VTI 120 2006>2013, C4 Grand Picasso I 2.0 HDi 138 2006>2013, C4 Grand Picasso I 2.0 HDi 150 2006>2013, C4 Grand Picasso I 2.0 i 16V 2006>2013, C4 II 1.2 THP 110 2009>2016, C4 II 1.2 THP 130 2009>2016, C4 II 1.4 VTI 95 2009>2016, C4 II 1.6 BlueHDi 100 2009>2016, C4 II 1.6 BlueHDi 115 2009>2016, C4 II 1.6 BlueHDi 120 2009>2016, C4 II 1.6 HDi 110 2009>2016, C4 II 1.6 HDi 115 2009>2016, C4 II 1.6 HDi 90 2009>2016, C4 II 1.6 THP 155 2009>2016, C4 II 1.6 VTI 120 2009>2016, C4 II 1.6 VTI 120 LPG 2009>2016, C4 II 2.0 HDi / BlueHDi 150 2009>2016, C4 II 2.0 HDi / BlueHDi 160 2009>2016, C4 Picasso I MPV 1.6 16V 2006>2013, C4 Picasso I MPV 1.6 HDi 2006>2013, C4 Picasso I MPV 1.6 THP 140 2006>2013, C4 Picasso I MPV 1.6 VTI 120 2006>2013, C4 Picasso I MPV 2.0 HDi 138 2006>2013, C4 Picasso I MPV 2.0 HDi 150 2006>2013, C4 Picasso I MPV 2.0 i 16V 2006>2013

GS2064 // NEW //
REAR WHEEL SENSOR (LEFT SIDE)
REPLACES / REEMPLAZA:
Mitsubishi: 4670A579, MN116243; **Meat & Doria:** 90907E

APPLICATION / APLICACIÓN:
MITSUBISHI: Asx 1.6 Mivec 2010>0, Asx 1.8 2008>0, Asx 1.8 Di-D 2010>0, Asx 1.8 Di-D 4Wd 2010>0, Lancer Viii 1.5 2008>0, Lancer Viii 1.5 Bifuel 2010>0, Lancer Viii 1.6 Mivec 2010>0, Lancer Viii 1.8 2008>0, Lancer Viii 1.8 Bifuel 2010>0, Lancer Viii 1.8 Di-D 2010>0, Lancer Viii 1.8 Flexfuel 2009>0, Lancer Viii 1.8 Flexfuel 2010>0, Lancer Viii 1.8 Mivec 2009>0, Lancer Viii 2.0 2006>0, Lancer Viii 2.0 2013>0, Lancer Viii 2.0 Di-D 2008>0, Lancer Viii Sportback 1.5 2008>0, Lancer Viii Sportback 1.5 Bifuel 2010>0, Lancer Viii Sportback 1.6 Mivec 2010>0, Lancer Viii Sportback 1.8 2008>0, Lancer Viii Sportback 1.8 Bifuel 2010>0, Lancer Viii Sportback 1.8 Di-D 2010>0, Lancer Viii Sportback 1.8 Flex 2009>0, Lancer Viii Sportback 1.8 Mivec 2009>0, Lancer Viii Sportback 2.0 Di-D 2008>0, Outlander li 2.0 2006>0, Outlander li 2.0 4Wd 2006>0, Outlander li 2.2 Di-D 2006>0, Outlander li 2.2 Di-D 4Wd 2006>0

GS2065 // NEW //
FRONT WHEEL SENSOR (BOTH SIDES)
REPLACES / REEMPLAZA:
Peugeot: 4545E7, 96552700, 9655270080, 0265007788; **Delphi:** SS20397; **Hitachi:** 131552; **Meat & Doria:** 90512; **Mobiletron:** AB-EU152

APPLICATION / APLICACIÓN:

CITROËN: Berlingo 1.4 i 2008>2014, Berlingo 1.6 2008>2014, Berlingo 1.6 BlueHDi 100 2008>2014, Berlingo 1.6 BlueHDi 120 2008>2014, Berlingo 1.6 HDi 110 2008>2014, Berlingo 1.6 HDi 115 2008>2014, Berlingo 1.6 HDi 115 4x4 2008>2014, Berlingo 1.6 HDi 75 / BlueHDi 75 2008>2014, Berlingo 1.6 HDi 75 16V 2008>2014, Berlingo 1.6 HDi 90 2008>2014, Berlingo 1.6 HDi 90 4x4 2008>2014, Berlingo 1.6 VTI 120 2008>2014, Berlingo 1.6 VTI 95 2008>2014, Berlingo / Berlingo FIRST Box Electric 2011>2011, Berlingo / Berlingo FIRST MPV 1.6 HDi 90 (MF9HX) 2005>2008, Berlingo Box 1.6 2008>1900, Berlingo Box 1.6 BlueHDi 100 2008>1900, Berlingo Box 1.6 BlueHDi 100 4x4 2008>1900, Berlingo Box 1.6 BlueHDi 120 2008>1900, Berlingo Box 1.6 HDi / BlueHDi 75 2008>1900, Berlingo Box 1.6 HDi 110 2008>1900, Berlingo Box 1.6 HDi 115 2008>1900, Berlingo Box 1.6 HDi 115 4x4 2008>1900, Berlingo Box 1.6 HDi 115 4x4 2008>1900, Berlingo Box 1.6 HDi 75 2008>1900, Berlingo Box 1.6 HDi 75 4x4 2008>1900, Berlingo Box 1.6 HDi 90 2008>1900, Berlingo Box 1.6 HDi 90 16V 2008>1900, Berlingo Box 1.6 HDi 90 4x4 2008>1900, Berlingo Box 1.6 VTI 120 2008>1900, Berlingo Box 1.6 VTI 95 2008>1900, Berlingo Box Electric 2008>1900, Berlingo Platparam/Chassis 1.6 BlueHDi 100 2008>1900, Berlingo Platparam/Chassis 1.6 HDi 90 2008>1900, Berlingo Platparam/Chassis 1.6 HDi 90 16V 2008>1900, Berlingo Platparam/Chassis 1.6 HDi 92 2008>1900, C4 Grand Picasso I 1.6 16V 2006>2013, C4 Grand Picasso I 1.6 HDi 110 2006>2013, C4 Grand Picasso I 1.6 THP 155 2006>2013, C4 Grand Picasso I 1.6 VTI 120 2006>2013, C4 Grand Picasso I 1.8 i 16V 2006>2013, C4 Grand Picasso I 1.8 i 16V CNG 2006>2013, C4 Grand Picasso I 1.8 i 16V Flex 2006>2013, C4 Grand Picasso I 2.0 HDi 138 2006>2013, C4 Grand Picasso I 2.0 HDi 150 2006>2013, C4 Grand Picasso I 2.0 HDi 165 2006>2013, C4 Grand Picasso I 2.0 i 16V 2006>2013, C4 Picasso I MPV 1.6 16V 2006>2013, C4 Picasso I MPV 1.6 HDi 2006>2013, C4 Picasso I MPV 1.6 HDi 110 2006>2013, C4 Picasso I MPV 1.6 THP 140 2006>2013, C4 Picasso I MPV 1.6 THP 155 2006>2013, C4 Picasso I MPV 1.6 VTI 120 2006>2013, C4 Picasso I MPV 1.8 Bifuel 2006>2013, C4 Picasso I MPV 1.8 i 16V 2006>2013, C4 Picasso I MPV 2.0 HDi 138 2006>2013, C4 Picasso I MPV 2.0 HDi 150 2006>2013, C4 Picasso I MPV 2.0 HDi 165 2006>2013, C4 Picasso I MPV 2.0 i 16V 2006>2013, C4 Picasso II 2.0 i 16V 2013>2014;

PEUGEOT: Partner Box 1.6 2008>1900, Partner Box 1.6 BlueHDi 100 2008>1900, Partner Box 1.6 BlueHDi 120 2008>1900, Partner Box 1.6 Flex 2008>1900, Partner Box 1.6 HDi 2008>1900, Partner Box 1.6 HDi / BlueHDi 75 2008>1900, Partner Box 1.6 HDi 16V 2008>1900, Partner Box 1.6 HDi 16V 4x4 2008>1900, Partner Box 1.6 HDi 90 2008>1900, Partner Box Électrique 2008>1900, Partner Platparam/Chassis 1.6 BlueHDi 100 2009>1900, Partner Platparam/Chassis 1.6 HDi 2009>1900, Partner Platparam/Chassis 1.6 HDi 16V 2009>1900, Partner Tepee 1.6 BlueHDi 100 2008>2016, Partner Tepee 1.6 BlueHDi 120 2008>2016, Partner Tepee 1.6 HDi 2008>2016, Partner Tepee 1.6 HDi / BlueHDi 75 2008>2016, Partner Tepee 1.6 HDi 16V 2008>2016, Partner Tepee 1.6 HDi 75 (16V) 2008>2016, Partner Tepee 1.6 HDi 90 2008>2016, Partner Tepee 1.6 VTI 2008>2016, Partner Tepee 1.6 VTI Flex 2008>2016, Partner Tepee Électrique 2008>2016

GS2066 // NEW //
REAR WHEEL SENSOR (BOTH SIDES)
REPLACES / REEMPLAZA:
Peugeot: 4545E8, 96536631, 0265007789; **Delphi:** SS20402; **Hitachi:** 131594; **Meat & Doria:** 90513; **Mobiletron:** AB-EU153

APPLICATION / APLICACIÓN:

PEUGEOT: 5008 1.2 2009>2017, 5008 1.6 16V 2009>2017, 5008 1.6 BlueHDi 120 2009>2017, 5008 1.6 HDi 2009>2017, 5008 1.6 THP 150 2009>2017, 5008 1.6 THP 163 2009>2017, 5008 1.6 THP 165 2009>2017, 5008 2.0 HDi 2009>2017, 5008 2.0 HDi 136 / BlueHDi 136 2009>2017, 5008 2.0 HDi 150 / BlueHDi 150 2009>2017, Partner Box 1.6 2008>1900, Partner Box 1.6 BlueHDi 100 2008>1900, Partner Box 1.6 BlueHDi 120 2008>1900, Partner Box 1.6 Flex 2008>1900, Partner Box 1.6 HDi 2008>1900, Partner Box 1.6 HDi / BlueHDi 75 2008>1900, Partner Box 1.6 HDi 16V 2008>1900, Partner Box 1.6 HDi 16V 4x4 2008>1900, Partner Box 1.6 HDi 90 2008>1900, Partner Box Électrique 2008>1900, Partner Platparam/Chassis 1.6 BlueHDi 100 2009>1900, Partner Platparam/Chassis 1.6 HDi 2009>1900, Partner Platparam/Chassis 1.6 HDi 16V 2009>1900, Partner Tepee 1.6 BlueHDi 100 2008>2016, Partner Tepee 1.6 BlueHDi 120 2008>2016, Partner Tepee 1.6 HDi 2008>2016, Partner Tepee 1.6 HDi / BlueHDi 75 2008>2016, Partner Tepee 1.6 HDi 16V 2008>2016, Partner Tepee 1.6 HDi 75 (16V) 2008>2016, Partner Tepee 1.6 HDi 90 2008>2016, Partner Tepee 1.6 VTI 2008>2016, Partner Tepee 1.6 VTI Flex 2008>2016, Partner Tepee Électrique 2008>2016;

CITROËN: Berlingo 1.4 i 2008>2014, Berlingo 1.6 2008>2014, Berlingo 1.6 BlueHDi 100 2008>2014, Berlingo 1.6 BlueHDi 120 2008>2014, Berlingo 1.6 HDi 110 2008>2014, Berlingo 1.6 HDi 115 2008>2014, Berlingo 1.6 HDi 115 4x4 2008>2014, Berlingo 1.6 HDi 75 / BlueHDi 75 2008>2014, Berlingo 1.6 HDi 75 16V 2008>2014, Berlingo 1.6 HDi 90 2008>2014, Berlingo 1.6 HDi 90 4x4 2008>2014, Berlingo 1.6 VTI 120 2008>2014, Berlingo 1.6 VTI 95 2008>2014, Berlingo / Berlingo FIRST Box Electric 2011>2011, Berlingo Box 1.6 2008>1900, Berlingo Box 1.6 BlueHDi 100 2008>1900, Berlingo Box 1.6 BlueHDi 100 4x4 2008>1900, Berlingo Box 1.6 BlueHDi 120 2008>1900, Berlingo Box 1.6 HDi / BlueHDi 75 2008>1900, Berlingo Box 1.6 HDi 110 2008>1900, Berlingo Box 1.6 HDi 115 2008>1900, Berlingo Box 1.6 HDi 115 4x4 2008>1900, Berlingo Box 1.6 HDi 75 2008>1900, Berlingo Box 1.6 HDi 75 4x4 2008>1900, Berlingo Box 1.6 HDi 90 16V 2008>1900, Berlingo Box 1.6 HDi 90 4x4 2008>1900, Berlingo Box 1.6 VTI 120 2008>1900, Berlingo Box 1.6 VTI 95 2008>1900, Berlingo Box Electric 2008>1900, Berlingo Platparam/Chassis 1.6 BlueHDi 100 2008>1900, Berlingo Platparam/Chassis 1.6 HDi 90 2008>1900, Berlingo Platparam/Chassis 1.6 HDi 90 16V 2008>1900, Berlingo Platparam/Chassis 1.6 HDi 92 2008>1900, C4 Grand Picasso I 1.6 16V 2006>2013, C4 Grand Picasso I 1.6 HDi 110 2006>2013, C4 Grand Picasso I 1.6 THP 155 2006>2013, C4 Grand Picasso I 1.6 VTI 120 2006>2013, C4 Grand Picasso I 1.8 i 16V 2006>2013, C4 Grand Picasso I 1.8 i 16V CNG 2006>2013, C4 Grand Picasso I 1.8 i 16V Flex 2006>2013, C4 Grand Picasso I 2.0 HDi 138 2006>2013, C4 Grand Picasso I 2.0 HDi 150 2006>2013, C4 Grand Picasso I 2.0 HDi 165 2006>2013, C4 Grand Picasso I 2.0 i 16V 2006>2013, C4 Picasso I MPV 1.6 16V 2006>2013, C4 Picasso I MPV 1.6 HDi 2006>2013, C4 Picasso I MPV 1.6 HDi 110 2006>2013, C4 Picasso I MPV 1.6 THP 140 2006>2013, C4 Picasso I MPV 1.6 THP 155 2006>2013, C4 Picasso I MPV 1.6 VTI 120 2006>2013, C4 Picasso I MPV 1.8 Bifuel 2006>2013, C4 Picasso I MPV 1.8 i 16V 2006>2013, C4 Picasso I MPV 2.0 HDi 138 2006>2013, C4 Picasso I MPV 2.0 HDi 150 2006>2013, C4 Picasso I MPV 2.0 HDi 165 2006>2013, C4 Picasso I MPV 2.0 i 16V 2006>2013, C4 Picasso II 2.0 i 16V 2013>2014

GS2067 // NEW //
REAR WHEEL SENSOR (BOTH SIDES)
REPLACES / REEMPLAZA:
Citroën: 454554, 0986594021; **Bosch:** 0 986 594 021;

Delphi: SS20014; **Mobiletron:** AB-EU262

APPLICATION / APLICACIÓN:

CITROËN: Xantia 1.6 i 1993>0, Xantia 1.8 i 1993>0, Xantia 1.8 i 16V 1995>0, Xantia 1.9 D 1994>0, Xantia 1.9 Sd 1996>0, Xantia 1.9 Turbo D 1993>0, Xantia 2.0 1993>0, Xantia 2.0 i 1993>0, Xantia 2.0 i 16V 1993>0, Xantia 2.0 Turbo 1995>0, Xantia 2.1 Turbo D 12V 1995>0, Xantia 3.0 i 24V 1997>0, Xantia Break 1.8 i 1993>0, Xantia Break 1.8 i 16V 1995>0, Xantia Break 1.9 Sd 1996>0, Xantia Break 1.9 Turbo D 1993>0, Xantia Break 2.0 i 1993>0, Xantia Break 2.0 i 16V 1993>0, Xantia Break 2.0 Turbo 1995>0, Xantia Break 2.1 Turbo D 12V 1995>0

GS2068 // NEW //
FRONT WHEEL SENSOR (BOTH SIDES)
REPLACES / REEMPLAZA:
Citroën: 454543, 96113241; **A.B.S.:** 30328

APPLICATION / APLICACIÓN:

CITROËN: Xantia 1.6 i 1993>0, Xantia 1.8 i 1993>0, Xantia 1.9 D 1994>0, Xantia 2.0 i 1993>0, Xantia 2.0 i 16V 1993>0

GS2069 // NEW //
REAR WHEEL SENSOR (BOTH SIDES)
REPLACES / REEMPLAZA:
Citroën: 454575, 1482480080, 0265006504; **Bosch:** 0 265 006 504; **Mobiletron:** AB-EU272

APPLICATION / APLICACIÓN:
CITROËN: Evasion Mpv 1.8 1995>0, Evasion Mpv 1.9 Td 1994>0, Evasion Mpv 2.0 1994>0, Evasion Mpv 2.0 16V 1998>0, Evasion Mpv 2.0 Hdi 1999>0, Evasion Mpv 2.0 Hdi 16V 1999>0, Evasion Mpv 2.0 Turbo C.T. 1994>0, Evasion Mpv 2.1 Td 1996>0, Jumpy 1.6 1995>0, Jumpy 1.9 D 1995>0, Jumpy 1.9 D 70 1998>0, Jumpy 1.9 Td 1994>0, Jumpy 2.0 1994>0, Jumpy 2.0 Hdi 110 2000>0, Jumpy 2.0 Hdi 95 1999>0, Jumpy 2.0 I 16V 2000>0, Jumpy Box 1.6 I 1995>0, Jumpy Box 1.9 D 1995>0, Jumpy Box 1.9 D 70 1998>0, Jumpy Box 1.9 Dt 1995>0, Jumpy Box 1.9 Td 1994>0, Jumpy Box 2.0 1994>0, Jumpy Box 2.0 Hdi 95 1999>0, Jumpy Box 2.0 I 16V 2000>0, Jumpy Platform/Chassis 1.9 Td 1994>0, Jumpy Platform/Chassis 2.0 Hdi 95 1999>0;

FIAT: Scudo Box 1.6 1995>0, Scudo Box 1.9 D 1995>0, Scudo Box 1.9 Td 1994>0, Scudo Box 2.0 1994>0, Scudo Box 2.0 Jtd 1999>0, Scudo Box 2.0 Jtd 16V 1999>0, Scudo Combinato 1.6 1995>0, Scudo Combinato 1.9 D 1995>0, Scudo Combinato 1.9 Td 1994>0, Scudo Combinato 1.9 Td Eco 1996>0, Scudo Combinato 2.0 16V 1998>0, Scudo Combinato 2.0 Jtd 1999>0, Scudo Combinato 2.0 Jtd 16V 1999>0, Scudo Platform/Chassis 1.6 1995>0, Scudo Platform/Chassis 1.9 Td 1994>0, Scudo Platform/Chassis 2.0 Jtd 1999>0, Scudo Platform/Chassis 2.0 Jtd 16V 1999>0, Ulysse 1.8 1997>0, Ulysse 1.9 Td 1994>0, Ulysse 1.9 Td 1995>0, Ulysse 2.0 1994>0, Ulysse 2.0 16V 1998>0, Ulysse 2.0 16V 2000>0, Ulysse 2.0 Jtd 1999>0, Ulysse 2.0 Jtd 16V 1999>0, Ulysse 2.0 Turbo 1994>0, Ulysse 2.1 Td 1996>0;

LANCIA: Zeta 2.0 16V 2000>0;

PEUGEOT: 806 1.8 1995>0, 806 1.9 Td 1994>0, 806 2.0 1994>0, 806 2.0 16V 1998>0, 806 2.0 Hdi 1999>0, 806 2.0 Hdi 16V 1999>0, 806 2.0 Turbo 1994>0, 806 2.1 Td 12V 1996>0, Expert 1.6 1995>0, Expert 1.8 1995>0, Expert 1.9 D 1995>0, Expert 1.9 Td 1994>0, Expert 2.0 1994>0, Expert 2.0 Hdi 1999>0, Expert 2.0 Hdi 16V 1999>0, Expert Box 1.6 1995>0, Expert Box 1.8 1995>0, Expert Box 1.9 D 1995>0, Expert Box 1.9 D 70 1998>0, Expert Box 1.9 Td 1994>0, Expert Box 2.0 Hdi 1999>0, Expert Platform/Chassis 1.6 1995>0, Expert Platform/Chassis 1.9 D 1995>0, Expert Platform/Chassis 1.9 Td 1994>0, Expert Platform/Chassis 2.0 Hdi 1999>0

GS2070 // NEW //
FRONT WHEEL SENSOR (BOTH SIDES)
REPLACES / REEMPLAZA:
Citroën: 454567, 1480846080; **Bosch:** 0 265 006 388; **Delphi:** SS20268; **Mobiletron:** AB-EU270

APPLICATION / APLICACIÓN:
CITROËN: Evasion Mpv 1.8 1995>0, Evasion Mpv 1.9 Td 1994>0, Evasion Mpv 2.0 1994>0, Evasion Mpv 2.0 16V 1998>0, Evasion Mpv 2.0 Hdi 1999>0, Evasion Mpv 2.0 Hdi 16V 1999>0, Evasion Mpv 2.0 Turbo C.T. 1994>0, Evasion Mpv 2.1 Td 1996>0, Jumpy 1.6 1995>0, Jumpy 1.9 D 1995>0, Jumpy 1.9 D 70 1998>0, Jumpy 1.9 Td 1994>0, Jumpy 2.0 1994>0, Jumpy 2.0 Hdi 110 2000>0, Jumpy 2.0 Hdi 95 1999>0, Jumpy 2.0 I 16V 2000>0, Jumpy Box 1.6 I 1995>0, Jumpy Box 1.9 D 1995>0, Jumpy Box 1.9 D 70 1998>0, Jumpy Box 1.9 Dt 1995>0, Jumpy Box 1.9 Td 1994>0, Jumpy Box 2.0 1994>0, Jumpy Box 2.0 Hdi 95 1999>0, Jumpy Box 2.0 I 16V 2000>0, Jumpy Platform/Chassis 1.9 Td 1994>0, Jumpy Platform/Chassis 2.0 Hdi 95 1999>0;

FIAT: Scudo Box 1.6 1995>0, Scudo Box 1.9 D 1995>0, Scudo Box 1.9 Td 1994>0, Scudo Box 2.0 1994>0, Scudo Box 2.0 Jtd 1999>0, Scudo Box 2.0 Jtd 16V 1999>0, Scudo Combinato 1.6 1995>0, Scudo Combinato 1.9 D 1995>0, Scudo Combinato 1.9 Td 1994>0, Scudo Combinato 1.9 Td Eco 1996>0, Scudo Combinato 2.0 16V 1998>0, Scudo Combinato 2.0 Jtd 1999>0, Scudo Combinato 2.0 Jtd 16V 1999>0, Scudo Platform/Chassis 1.6 1995>0, Scudo Platform/Chassis 1.9 Td 1994>0, Scudo Platform/Chassis 2.0 Jtd 1999>0, Scudo Platform/Chassis 2.0 Jtd 16V 1999>0, Ulysse 1.8 1997>0, Ulysse 1.9 Td 1994>0, Ulysse 1.9 Td 1995>0, Ulysse 2.0 1994>0, Ulysse 2.0 16V 1998>0, Ulysse 2.0 16V 2000>0, Ulysse 2.0 Jtd 1999>0, Ulysse 2.0 Jtd 16V 1999>0, Ulysse 2.0 Turbo 1994>0, Ulysse 2.1 Td 1996>0;

LANCIA: Zeta 2.0 16V 1998>0, Zeta 2.0 16V 2000>0, Zeta 2.0 Jtd 1999>0, Zeta 2.0 Jtd 16V 2001>0, Zeta 2.0 Turbo 1995>0, Zeta 2.1 Td 1996>0;

PEUGEOT: 806 1.8 1995>0, 806 1.9 Td 1994>0, 806 2.0 1994>0, 806 2.0 16V 1998>0, 806 2.0 Hdi 1999>0, 806 2.0 Hdi 16V 1999>0, 806 2.0 Turbo 1994>0, 806 2.1 Td 12V 1996>0, Expert 1.6 1995>0, Expert 1.8 1995>0, Expert 1.9 D 1995>0, Expert 1.9 Td 1994>0, Expert 2.0 1994>0, Expert 2.0 Hdi 1999>0, Expert 2.0 Hdi 16V 1999>0, Expert Box 1.6 1995>0, Expert Box 1.8 1995>0, Expert Box 1.9 D 1995>0, Expert Box 1.9 D 70 1998>0, Expert Box 1.9 Td 1994>0, Expert Box 2.0 Hdi 1999>0, Expert Platform/Chassis 1.6 1995>0, Expert Platform/Chassis 1.9 D 1995>0, Expert Platform/Chassis 1.9 Td 1994>0, Expert Platform/Chassis 2.0 Hdi 1999>0

GS2072 // NEW //
FRONT WHEEL SENSOR (BOTH SIDES)
REPLACES / REEMPLAZA:
Citroën: 9670055080, 4545K5, 4545K6, 4545H9, 4545H5, 0986594567, 0986594596; **Meat & Doria:** 90601; **Mobiletron:** AB-EU484

APPLICATION / APLICACIÓN:
PEUGEOT: 407 1.6 Hdi 110 2004>2011, 407 1.8 2004>2011, 407 1.8 16V 2004>2011, 407 2.0 2004>2011, 407 2.0 16V 2004>2011, 407 2.0 Bioflex 2004>2011, 407 2.0 HDi 2004>2011, 407 2.0 HDi 135 2004>2011, 407 2.2 2004>2011, 407 2.2 16V 2004>2011, 407 2.2 HDi 2004>2011, 407 2.2 HDi 170 2004>2011, 407 2.7 HDi 2004>2011, 407 3.0 2004>2011, 407 Coupe 2.0 HDi 2005>2010, 407 Coupe 2.2 16V 2005>2010, 407 Coupe 2.7 HDi 2005>2010, 407 Coupe 3.0 HDi 2005>2010, 407 Coupe 3.0 V6 2005>2010, 407 SW 1.6 Hdi 110 2004>2011, 407 SW 1.8 2004>2011, 407 SW 1.8 16V 2004>2011, 407 SW 2.0 2004>2011, 407 SW 2.0 16V 2004>2011, 407 SW 2.0 Bioflex 2004>2011, 407 SW 2.0 HDi 2004>2011, 407 SW 2.0 HDi 135 2004>2011, 407 SW 2.2 2004>2011, 407 SW 2.2 16V 2004>2011, 407 SW 2.2 HDi 2004>2011, 407 SW 2.2 HDi 170 2004>2011, 407 SW 2.7 HDi 2004>2011, 407 SW 3.0 2004>2011, 508 I 2.2 HDi 2010>2018, 508 SW I 2.2 HDi 2010>2018;

CITROËN: C5 II Break 2.2 HDi 2004>2007, C5 III 1.6 Hdi 110 2008>2014, C5 III 1.6 Hdi 115 2008>2014, C5 III 1.6 THP 150 2008>2014, C5 III 1.6 THP 155 2008>2014, C5 III 1.6 VTI 120 2008>2014, C5 III 1.8 16V 2008>2014, C5 III 2.0 16V 2008>2014, C5 III 2.0 16V BioFlex 2008>2014, C5 III 2.0 HDi 2008>2014, C5 III 2.0 HDi 140 2008>2014, C5 III 2.0 HDi 150 / BlueHdi 150 2008>2014, C5 III 2.0 HDi 165 2008>2014, C5 III 2.0 HDi 180 2008>2014, C5 III 2.2 HDi 2008>2014, C5 III 2.2 HDi 200 2008>2014, C5 III 2.7 HDi 2008>2014, C5 III 3.0 HDi 240 2008>2014, C5 III 3.0 V6 2008>2014, C5 III Break 1.6 Hdi 110 2008>2014, C5 III Break 1.6 Hdi 115 2008>2014, C5 III Break 1.6 THP 150 2008>2014, C5 III Break 1.6 THP 155 2008>2014, C5 III Break 1.6 VTI 120 2008>2014, C5 III Break 1.8 16V 2008>2014, C5 III Break 2.0 16V 2008>2014, C5 III Break 2.0 HDi 140 2008>2014, C5 III Break 2.0 HDi 150 / BlueHdi 150 2008>2014, C5 III Break 2.0 HDi 165 2008>2014, C5 III Break 2.0 HDi 180 2008>2014, C5 III Break 2.2 HDi 2008>2014, C5 III Break 2.2 HDi 165 2008>2014, C5 III Break 2.2 HDi 200 2008>2014, C5 III Break 2.7 HDi 2008>2014, C5 III Break 3.0 HDi 240 2008>2014, C5 III Break 3.0 V6 2008>2014, C6 2.2 HDi 2005>2012, C6 2.7 HDi 2005>2012, C6 3.0 HDi 2005>2012, C6 3.0 V6 2005>2012

GS2073 // NEW //
FRONT WHEEL SENSOR (LEFT SIDE)
REPLACES / REEMPLAZA:
Mitsubishi: MN102573; **Meat & Doria:** 90534; **Bremi:** 50714

APPLICATION / APLICACIÓN:
MITSUBISHI: L 200/Triton 2.5 2005>2015, Pajero/ Montero IV 3.0/3.2 2007, Pajero/ Montero Sport II 3.0/3.2/3.5 2008

GS2074 // NEW //
FRONT WHEEL SENSOR (RIGHT SIDE)
REPLACES / REEMPLAZA:
Mitsubishi: MN102574; **Meat & Doria:** 90535; **Bremi:** 50715

APPLICATION / APLICACIÓN:
MITSUBISHI: L200 Triton 2007>2011, Pajero Dakar 2008>2011



GS2075 // NEW //

FRONT WHEEL SENSOR (BOTH SIDES)

REPLACES / REEMPLAZA:

BMW: 34526756379; **Bosch:** 0 986 594 529; **Delphi:** SS20010; **Hitachi:** 131517; **Meat & Doria:** 90079; **Mobiletron:** AB-EU190

APPLICATION / APLICACIÓN:

BMW: X5 3.0 d 2000>2006, X5 3.0 i 2000>2006, X5 4.4 i 2000>2006, X5 4.6 is 2000>2006, X5 4.8 is 2000>2006;

SEAT: Alhambra 1.8 T 20V 1996>2010, Alhambra 1.9 TDI 1996>2010, Alhambra 1.9 TDI 4motion 1996>2010, Alhambra 2.0 i 1996>2010;

FORD: Galaxy 1.9 TDI 1995>2006, Galaxy 2.3 16V 1995>2006;

VW: Sharan 1.8 T 20V 1995>2010, Sharan 1.9 TDI 1995>2010, Sharan 1.9 TDI 4motion 1995>2010, Sharan 2.0 1995>2010, Sharan 2.8 V6 24V 4motion 1995>2010



GS2076 // NEW //

REAR WHEEL SENSOR (BOTH SIDES)

REPLACES / REEMPLAZA:

BMW: 34526756380; **Bosch:** 0 986 594 530; **Delphi:** SS20163; **Hitachi:** 131518; **Meat & Doria:** 90080; **Mobiletron:** AB-EU191

APPLICATION / APLICACIÓN:

BMW: X5 3.0 d 2000>2006, X5 3.0 i 2000>2006, X5 4.4 i 2000>2006, X5 4.6 is 2000>2006



GS2077 // NEW //

REAR WHEEL SENSOR (LEFT SIDE)

REPLACES / REEMPLAZA:

Meat & Doria: 90536; **Bremi:** 50716

APPLICATION / APLICACIÓN:

MITSUBISHI: L 200 / TRITON 2.5 2005>2015



GS2078 // NEW //

FRONT WHEEL SENSOR (RIGHT SIDE)

REPLACES / REEMPLAZA:

Mitsubishi: MN102578, 4670A600; **Meat & Doria:** 90537; **Bremi:** 50717

APPLICATION / APLICACIÓN:

MITSUBISHI: L 200/Triton 2.5 2005>2015, Pajero/ Montero IV 3.0/3.2 2007, Pajero/ Montero Sport II 3.0/3.2/3.5 2008



GS2079 // NEW //

REAR WHEEL SENSOR (BOTH SIDES)

REPLACES / REEMPLAZA:

BMW: 34526784901, 0265008232; **Meat & Doria:** 90866E; **Mobiletron:** AB-EU222

APPLICATION / APLICACIÓN:

BMW: 5 518 d 2009>2016, 5 520 d 2009>2016, 5 520 d xDrive 2009>2016, 5 520 i 2009>2016, 5 523 i 2009>2016, 5 525 d 2009>2016, 5 525 d xDrive 2009>2016, 5 528 i 2009>2016, 5 528 i xDrive 2009>2016, 5 530 d 2009>2016, 5 530 d xDrive 2009>2016, 5 530 i 2009>2016, 5 535 d 2009>2016, 5 535 d xDrive 2009>2016, 5 535 i 2009>2016, 5 535 i xDrive 2009>2016, 5 550 i 2009>2016, 5 550 i xDrive 2009>2016, 5 ActiveHybrid 2009>2016, 5 M 550 d xDrive 2009>2016, 5 M5 2009>2016, 5 M5 Competition 2009>2016, 5 M5 Edition 30 2009>2016, 5 Gran Turismo 530 d xDrive 2009>2017, 5 Gran Turismo 535 d xDrive 2009>2017, 5 Gran Turismo 535 i xDrive 2009>2017, 5 Gran Turismo 550 i xDrive 2009>2017, 5 Touring 518 d 2009>2017, 5 Touring 520 d 2009>2017, 5 Touring 520 d xDrive 2009>2017, 5 Touring 520 i 2009>2017, 5 Touring 523 i 2009>2017, 5 Touring 525 d 2009>2017, 5 Touring 525 d xDrive 2009>2017, 5 Touring 528 i 2009>2017, 5 Touring 528 i xDrive 2009>2017, 5 Touring 530 d 2009>2017, 5 Touring 530 d xDrive 2009>2017, 5 Touring 530 i 2009>2017, 5 Touring 535 d 2009>2017, 5 Touring 535 d xDrive 2009>2017, 5 Touring 535 i 2009>2017, 5 Touring 535 i xDrive 2009>2017, 5 Touring 550 i 2009>2017, 5 Touring M 550 d xDrive 2009>2017, 6 Convertible 640 d 2010>2018, 6 Convertible 640 d xDrive 2010>2018, 6 Convertible 640 i 2010>2018, 6 Convertible 640 i xDrive 2010>2018, 6 Convertible 650 i 2010>2018, 6 Convertible 650 i xDrive 2010>2018, 6 Convertible M6 2010>2018, 6 Convertible M6 Competition 2010>2018, 6 Coupe 640 d 2011>2017, 6 Coupe 640 d xDrive 2011>2017, 6 Coupe 640 i 2011>2017, 6 Coupe 640 i xDrive 2011>2017, 6 Coupe 650 i 2011>2017, 6 Coupe 650 i xDrive 2011>2017, 6 Coupe M6 2011>2017, 6 Coupe M6 Competition 2011>2017, 6 Gran Coupe 640 d 2012>2018, 6 Gran Coupe 640 d xDrive 2012>2018, 6 Gran Coupe 640 i 2012>2018, 6 Gran Coupe 640 i xDrive 2012>2018, 6 Gran Coupe 650 i 2012>2018, 6 Gran Coupe 650 i xDrive 2012>2018, 6 Gran Coupe M6 2012>2018, 6 Gran Coupe M6 Competition 2012>2018



GS2080

REAR WHEEL SENSOR (BOTH SIDES)

REPLACES / REEMPLAZA:

Chevrolet: 96626080

Opel: 96626080, 4809379

APPLICATION / APLICACIÓN:

Chevrolet: Captiva, Equinox

Opel: Antara 2.0/2.2/2.4/3.0

PS: set of GS2313



GS2081 // NEW //

FRONT WHEEL SENSOR (LEFT SIDE)

REPLACES / REEMPLAZA:

Citroën: 454594, 14888410, 1493882080, 0265007083;

Bosch: 0 265 007 083; **Delphi:** SS20120; **Meat & Doria:** 90185; **Mobiletron:** AB-EU089

APPLICATION / APLICACIÓN:

PEUGEOT: 807 2.0 2002>1900, 807 2.0 16V 2002>1900, 807 2.0 HDi 2002>1900, 807 2.2 2002>1900, 807 2.2 HDi 2002>1900, 807 3.0 V6 2002>1900;

CITROËN: C8 2.0 2002>1900, C8 2.0 16V 2002>1900, C8 2.0 HDi 2002>1900, C8 2.0 HDi 135 2002>1900, C8 2.2 2002>1900, C8 2.2 HDi 2002>1900, C8 3.0 V6 2002>1900, C8 2.0 HDi 165 2002>1900;

LANCIA: PHEDRA 2.0 (179AXA11, 179AXA1A) 2002>2010, PHEDRA 2.0 D Multijet 2002>2010, PHEDRA 2.0 JTD 2002>2010, PHEDRA 2.0 JTD (179AXB1A) 2002>2010, PHEDRA 2.2 JTD (179AXC1A) 2002>2010, PHEDRA 3.0 V6 2002>2010, PHEDRA 2.2 D Multijet 2002>2010, PHEDRA 2.2 JTD 2002>2010;

FIAT: ULYSSE 2.0 (179BXA11, 179BXA1A) 2002>2011, ULYSSE 2.0 D Multijet 2002>2011, ULYSSE 2.0 JTD 2002>2011, ULYSSE 2.2 JTD 2002>2011, ULYSSE 3.0 2002>2011, ULYSSE 2.2 D Multijet 2002>2011, ULYSSE 2.0 16V (220AQ5) 1999>2002, ULYSSE 2.0 JTD 16V 1999>2002

GS2082 // NEW //

FRONT WHEEL SENSOR (RIGHT SIDE)

REPLACES / REEMPLAZA:

Citroën: 454595, 1493883080, 0265007084; **Bosch:** 0 265 007 084; **Delphi:** SS20121; **Meat & Doria:** 90186; **Mobiletron:** AB-EU090

APPLICATION / APLICACIÓN:

PEUGEOT: 807 2.0 2002>1900, 807 2.0 16V 2002>1900, 807 2.0 HDi 2002>1900, 807 2.2 2002>1900, 807 2.2 HDi 2002>1900, 807 3.0 V6 2002>1900;

CITROËN: C8 2.0 2002>1900, C8 2.0 16V 2002>1900, C8 2.0 HDi 2002>1900, C8 2.0 HDi 135 2002>1900, C8 2.2 2002>1900, C8 2.2 HDi 2002>1900, C8 3.0 V6 2002>1900, C8 2.0 HDi 165 2002>1900;

LANCIA: PHEDRA 2.0 (179AXA11, 179AXA1A) 2002>2010, PHEDRA 2.0 D Multijet 2002>2010, PHEDRA 2.0 JTD 2002>2010, PHEDRA 2.0 JTD (179AXB1A) 2002>2010, PHEDRA 2.2 JTD (179AXC1A) 2002>2010, PHEDRA 3.0 V6 2002>2010, PHEDRA 2.2 D Multijet 2002>2010, PHEDRA 2.2 JTD 2002>2010;

FIAT: ULYSSE 2.0 (179BXA11, 179BXA1A) 2002>2011, ULYSSE 2.0 D Multijet 2002>2011, ULYSSE 2.0 JTD 2002>2011, ULYSSE 2.2 JTD 2002>2011, ULYSSE 3.0 2002>2011, ULYSSE 2.2 D Multijet 2002>2011, ULYSSE 2.0 16V (220AQ5) 1999>2002, ULYSSE 2.0 JTD 16V 1999>2002



GS2083 // NEW //

REAR WHEEL SENSOR (BOTH SIDES)

REPLACES / REEMPLAZA:

Citroën: 1494167080, 454596, 0986594566; **Bosch:**

0 986 594 566; **Delphi:** SS20119; **Cargo:** 182316; **Meat & Doria:** 90187; **Mobiletron:** AB-EU091

APPLICATION / APLICACIÓN:

PEUGEOT: 807 2.0 2002>1900, 807 2.0 16V 2002>1900, 807 2.0 HDi 2002>1900, 807 2.2 2002>1900, 807 2.2 HDi 2002>1900, 807 3.0 V6 2002>1900, 607 2.0 HDi 2001>2004;

CITROËN: C8 2.0 2002>1900, C8 2.0 16V 2002>1900, C8 2.0 HDi 2002>1900, C8 2.0 HDi 135 2002>1900, C8 2.0 HDi 165 2002>1900, C8 2.2 2002>1900, C8 2.2 HDi 2002>1900, C8 3.0 V6 2002>1900, C5 I 1.8 16V (DC6FZB, DC6FZE) 2001>2005, C5 I 2.0 16V (DCRFNC, DCRFNF) 2001>2005, C5 I 2.0 16V HPI (DCRLZB) 2001>2005, C5 I 2.0 HDi (DCRHYB) 2001>2005, C5 I 2.0 HDi (DCRHZB, DCRHZE) 2001>2005, C5 I 2.2 HDi (DC4HXB, DC4HXE) 2001>2005, C5 I 3.0 V6 (DCXFXC, DCXFXF) 2001>2005, C5 I Break 1.8 16V (DE6FZB, DE6FZE) 2001>2004, C5 I Break 2.0 16V (DERFNF, DERFNC, RERFNC) 2001>2004, C5 I Break 2.0 16V HPI (DERLZB) 2001>2004, C5 I Break 2.0 HDi (DERHSB, DERHSE) 2001>2004, C5 I Break 2.0 HDi (DERHYB) 2001>2004, C5 I Break 2.0 HDi (DERHQB, DERHQE) 2001>2004, C5 I Break 2.2 HDi (DE4HXB, DE4HXE) 2001>2004, C5 I Break 3.0 V6 (DEXFXC, DEXFXF) 2001>2004, C5 II 1.6 HDi (RC8HQB) 2004>2007, C5 II 1.8 16V 2004>2007, C5 II 1.8 16V (RC6FZB) 2004>2007, C5 II 2.0 16V (RCRFJB, RCRFJC) 2004>2007, C5 II 2.0 HDi (RCRHRH) 2004>2007, C5 II 2.2 HDi 2004>2007, C5 II 2.2 HDi (RC4HXE) 2004>2007, C5 II 3.0 V6 2004>2007, C5 II 3.0 V6 (RCXFUF) 2004>2007, C5 II Break 1.6 HDi (RE8HQB) 2004>2007, C5 II Break 1.8 16V 2004>2007, C5 II Break 1.8 16V (RE6FZB) 2004>2007, C5 II Break 2.0 16V (RERFJB, RERFJC) 2004>2007, C5 II Break 2.0 HDi (RERHRH) 2004>2007, C5 II Break 2.2 HDi 2004>2007, C5 II Break 2.2 HDi (RE4HXE) 2004>2007, C5 II Break 3.0 V6 2004>2007, C5 II Break 3.0 V6 (REXFUF) 2004>2007, LANCIA: PHEDRA 2.0 (179AXA11, 179AXA1A) 2002>2010, PHEDRA 2.0 D Multijet 2002>2010, PHEDRA 2.0 JTD 2002>2010, PHEDRA 2.0 JTD (179AXB1A) 2002>2010, PHEDRA 2.2 D Multijet 2002>2010, PHEDRA 2.2 JTD (179AXC1A) 2002>2010, PHEDRA 3.0 V6 2002>2010;

FIAT: ULYSSE 2.0 (179BXA11, 179BXA1A) 2002>2011, ULYSSE 2.0 D Multijet 2002>2011, ULYSSE 2.0 JTD 2002>2011, ULYSSE 2.2 D Multijet 2002>2011, ULYSSE 2.2 JTD 2002>2011, ULYSSE 3.0 2002>2011, ULYSSE 2.0 16V (220AQ5) 1999>2002, ULYSSE 2.0 JTD 16V 1999>2002



GS2084 // NEW //

FRONT WHEEL SENSOR (BOTH SIDES)

REPLACES / REEMPLAZA:

Peugeot: 454597, 9665455580, 4545J9, 4545E4, 0986594551, 0986594597; **Bosch:** 0 986 594 551; **Delphi:** SS20133; **Hitachi:** 131591; **Cargo:** 182315;

Meat & Doria: 90151, 90151E; **Mobiletron:** AB-EU029

APPLICATION / APLICACIÓN:

PEUGEOT: 1007 1.4 2005>1900, 1007 1.4 16V 2005>1900, 1007 1.4 HDi 2005>1900, 1007 1.6 16V 2005>1900, 1007 1.6 HDi 2005>1900;

CITROËN: C2 1.1 2003>2009, C2 1.4 2003>2009, C2 1.4 16V 2003>2009, C2 1.4 HDi 2003>2009, C2 1.6 2003>2009, C2 1.6 HDi 2003>2009, C2 1.6 VTS 2003>2009, C2 ENTERPRISE 1.1 2003>2008, C2 ENTERPRISE 1.4 HDi 2003>2008, C3 I 1.1 i 2002>2012, C3 I 1.1 LPG 2002>2012, C3 I 1.4 2002>2012, C3 I 1.4 16V 2002>2012, C3 I 1.4 16V HDi 2002>2012, C3 I 1.4 BiFuel 2002>2012, C3 I 1.4 Flex 2002>2012, C3 I 1.4 HDi 2002>2012, C3 I 1.4 i 2002>2012, C3 I 1.4 i Bivalent 2002>2012, C3 I 1.6 16V 2002>2012, C3 I 1.6 16V HDi 2002>2012, C3 I 1.6 Bioflex 2002>2012, C3 Pluriel 1.4 2003>1900, C3 Pluriel 1.4 HDi 2003>1900, C3 Pluriel 1.6 2003>1900, C3 II 1.1 i 2009>2016, C3 II 1.4 2009>2016, C3 II 1.4 HDi 70 2009>2016, C3 II 1.4 LPG 2009>2016, C3 II 1.4 VTI 95 2009>2016, C3 II 1.6 HDi 2009>2016, C3 II 1.6 HDi 110 2009>2016, C3 II 1.6 HDi 115 2009>2016, C3 II 1.6 HDi 90 2009>2016, C3 II 1.6 VTI 120 2009>2016, C3 Picasso 1.4 VTI 95 2009>2016, C3 Picasso 1.4 VTI 95 LPG 2009>2016, C3 Picasso 1.6 HDi 2009>2016, C3 Picasso 1.6 HDi 110 2009>2016, C3 Picasso 1.6 HDi 115 2009>2016, C3 Picasso 1.6 HDi 90 2009>2016, C3 Picasso 1.6 VTI 120 2009>2016, C2 1.4 2006>2014, C2 1.6 2006>2014



GS2085 // NEW //

REAR WHEEL SENSOR (BOTH SIDES)

REPLACES / REEMPLAZA:

Peugeot: 4545J8, 4545E5, 9805066080, 9805083380, 0265008485, 0265007707, 0265009501; **Bosch:** 0 265 008 485; **Delphi:** SS20315; **Meat & Doria:** 90209, 90209E, **Mobiletron:** AB-EU273

APPLICATION / APLICACIÓN:

PEUGEOT: 207 1.4 2006>2015, 207 1.4 16V 2006>2015, 207 1.4 HDi 2006>2015, 207 1.6 16V RC 2006>2015, 207 1.6 16V Turbo 2006>2015, 207 1.6 16V VTI 2006>2015, 207 1.6 HDi 2006>2015, 207 1.6 HDi 110 2006>2015, 207 CC 1.6 16V 2007>2015, 207 CC 1.6 16V Turbo 2007>2015, 207 CC 1.6 HDi 2007>2015, 207 Saloon 1.4 2007>2014, 207 Saloon 1.6 2007>2014, 207 Saloon 1.9 XSD 2007>2014, 207 SW 1.4 2007>2013, 207 SW 1.4 16V 2007>2013, 207 SW 1.6 16V 2007>2013, 207 SW 1.6 HDi 2007>2013, 207 SW Box Body/Estate 1.6 HDi 2007>2012, 207 Van 1.4 HDi 2006>2012, 207 Van 1.6 HDi 2006>2012, 208 Box 1.4 HDi 2012>1900, 208 I 1.0 2012>2017, 208 I 1.2 2012>2017, 208 I 1.4 Flex 2012>2017, 208 I 1.4 HDi 2012>2017, 208 I 1.4 VTI 2012>2017, 208 I 1.6 2012>2017, 208 I 1.6 Flex 2012>2017, 208 I 1.6 GTi 2012>2017, 208 I 1.6 HDi 2012>2017, 208 I 1.6 HDi / BlueHDi 75 2012>2017, 301 1.2 VTI 72 2012>2017, 301 1.6 HDi 90 2012>2017, 301 1.6 VTI 115 2012>2017, 207 1.4 BiFuel 2006>2015, 207 1.4 Bioflex 2006>2015, 207 1.6 2006>2015, 207 1.6 16V 2006>2015, 207 Saloon 1.4 Flex 2007>2014, 207 Saloon 1.6 Bioflex 2007>2014, 207 SW 1.4 LPG 2007>2013, 207 SW 1.6 16V RC 2007>2013, 207 SW 1.6 16V Turbo 2007>2013, 207 Van 1.4 2006>2012, 207 Van 1.6 VTI 2006>2012, 208 I 1.2 THP 110 2012>2017;

CITROËN: C3 II 1.4 Flex 2009>2016, C3 II 1.6 VTI 120 Flex 2009>2016, C3 Picasso 1.4 Flex 2009>2016, C3 Picasso 1.4 VTI 95 2009>2016, C3 Picasso 1.4 VTI 95 LPG 2009>2016, C3 Picasso 1.6 Flex 2009>2016, C3 Picasso 1.6 HDi 2009>2016, C3 Picasso 1.6 HDi 110 2009>2016, C3 Picasso 1.6 HDi 115 2009>2016, C3 Picasso 1.6 HDi 90 2009>2016, C3 Picasso 1.6 VTI 2009>2016, C3 Picasso 1.6 VTI 120 2009>2016, C4 AIRCROSS 1.6 Flex 2010>2018, C-ELYSEE 1.2 VTI 72 2012>1900, C-ELYSEE 1.6 HDi 92 2012>1900, C-ELYSEE 1.6 VTI 115 2012>1900



GS2086 // NEW //

REAR WHEEL SENSOR (BOTH SIDES)

REPLACES / REEMPLAZA:

Peugeot: 96584207, 4545C4, 96461258, 9658420780, 454508, 4545L0, 4545K8, 96584107, 0265007779, 0265007645, 0265008017; **Bosch:** 0 265 007 779;

Delphi: SS20066; **Meat & Doria:** 90199; **Mobiletron:** AB-EU318

APPLICATION / APLICACIÓN:

PEUGEOT: 307 1.4 2000>2012, 307 1.4 16V 2000>2012, 307 1.4 HDi 2000>2012, 307 1.6 2000>2012, 307 1.6 16V 2000>2012, 307 1.6 HDi 2000>2012, 307 1.6 HDi 110 2000>2012, 307 2.0 2000>2012, 307 2.0 16V 2000>2012, 307 2.0 HDi 110 2000>2012, 307 2.0 HDi 135 2000>2012, 307 2.0 HDi 90 2000>2012, 307 Break 1.4 2002>2009, 307 Break 1.4 16V 2002>2009, 307 Break 1.4 HDi 2002>2009, 307 Break 1.6 16V 2002>2009, 307 Break 1.6 BioFlex 2002>2009, 307 Break 1.6 HDi 2002>2009, 307 Break 1.6 HDi 110 2002>2009, 307 Break 2.0 2002>2009, 307 Break 2.0 16V 2002>2009, 307 Break 2.0 HDi 110 2002>2009, 307 Break 2.0 HDi 135 2002>2009, 307 Break 2.0 HDi 90 2002>2009, 307 CC 1.6 16V 2003>2009, 307 CC 2.0 16V 2003>2009, 307 CC 2.0 HDi 135 2003>2009, 307 Saloon 2.0 2004>2012, 307 SW 1.4 2002>2009, 307 SW 1.4 16V 2002>2009, 307 SW 1.6 16V 2002>2009, 307 SW 1.6 BioFlex 2002>2009, 307 SW 1.6 HDi 110 2002>2009, 307 SW 2.0 16V 2002>2009, 307 SW 2.0 HDi 110 2002>2009, 307 SW 2.0 HDi 135 2002>2009, 307 SW 2.0 HDi 90 2002>2009, 307 SW Box Body/Estate 1.4 HDi 2002>2009, 307 SW Box Body/Estate 2.0 HDi 2002>2009, 307 1.6 BioFlex 2000>2012, 307 1.6 Flex 2000>2012, 307 2.0 Flex 2000>2012, 307 Saloon 1.6 2004>2012, 307 Saloon 1.6 Flex 2004>2012, 307 Saloon 2.0 Flex 2004>2012, 307 Saloon 2.0 HDi 2004>2012, 307 SW 1.6 HDi 90 2002>2009, 307 SW Box Body/Estate 1.6 HDi 2002>2009;

CITROËN: C4 Coupe 1.4 16V 2004>2011, C4 Coupe 1.6 16V 2004>2011, C4 Coupe 1.6 HDi 2004>2011, C4 Coupe 1.6 THP 150 2004>2011, C4 Coupe 1.6 VTi 120 2004>2011, C4 Coupe 2.0 16V 2004>2011, C4 Coupe 2.0 HDi 2004>2011, C4 Coupe 2.0 VTR 2004>2011, C4 I 1.4 16V 2004>2011, C4 I 1.6 16V 2004>2011, C4 I 1.6 16V Bio-Flex 2004>2011, C4 I 1.6 HDi 2004>2011, C4 I 1.6 THP 140 2004>2011, C4 I 1.6 THP 150 2004>2011, C4 I 1.6 VTi 120 2004>2011, C4 I 2.0 16V 2004>2011, C4 I 2.0 HDi 2004>2011, C4 I Box Body / Hatchback 2.0 HDi 2005>2010, C4 I Saloon 1.6 16V 2006>2011, C4 I Saloon 1.6 HDi 2006>2011, C4 I Saloon 2.0 16V 2006>2011, C4 I Saloon 2.0 HDi 2006>2011, C4 Grand Picasso I 1.6 HDi 2006>2013, C4 Grand Picasso I 2.0 HDi 138 2006>2013, C4 Grand Picasso I 2.0 I 16V 2006>2013



GS2087 // NEW //

REAR WHEEL SENSOR (BOTH SIDES)

REPLACES / REEMPLAZA:

Citroën: 454589, 4545H7, 4545F8, 96353848, 96436605, 96449668, 96436880, 96526967, 4545C2, 0265007424, 0265007664, 0265008018; **Bosch:** 0 265 007 424;

Delphi: SS20025; **Cargo:** 181908; **Hitachi:** 131582; **Meat & Doria:** 90291; **Mobiletron:** AB-EU001

APPLICATION / APLICACIÓN:

PEUGEOT: 307 1.4 2000>2012, 307 1.4 16V 2000>2012, 307 1.4 HDi 2000>2012, 307 1.6 2000>2012, 307 1.6 16V 2000>2012, 307 1.6 HDi 2000>2012, 307 1.6 HDi 110 2000>2012, 307 2.0 2000>2012, 307 2.0 16V 2000>2012, 307 2.0 HDi 110 2000>2012, 307 2.0 HDi 135 2000>2012, 307 2.0 HDi 90 2000>2012, 307 Break 1.4 2002>2009, 307 Break 1.4 16V 2002>2009, 307 Break 1.4 HDi 2002>2009, 307 Break 1.6 16V 2002>2009, 307 Break 1.6 HDi 2002>2009, 307 Break 1.6 HDi 110 2002>2009, 307 Break 2.0 2002>2009, 307 Break 2.0 HDi 110 2002>2009, 307 Break 2.0 HDi 135 2002>2009, 307 Break 2.0 HDi 90 2002>2009, 307 CC 1.6 16V 2003>2009, 307 CC 2.0 16V 2003>2009, 307 CC 2.0 HDi 135 2003>2009, 307 Saloon 2.0 2004>2012, 307 SW 1.4 2002>2009, 307 SW 1.4 16V 2002>2009, 307 SW 1.6 16V 2002>2009, 307 SW 1.6 BioFlex 2002>2009, 307 SW 1.6 HDi 110 2002>2009, 307 SW 2.0 16V 2002>2009, 307 SW 2.0 HDi 110 2002>2009, 307 SW 2.0 HDi 135 2002>2009, 307 SW 2.0 HDi 90 2002>2009, 307 SW Box Body/Estate 1.4 HDi 2002>2009, 307 SW Box Body/Estate 2.0 HDi 2002>2009, 307 1.6 BioFlex 2000>2012, 307 1.6 Flex 2000>2012, 307 Break 2.0 16V 2002>2009, 307 SW 1.6 HDi 90 2002>2009, 307 SW Box Body/Estate 1.6 HDi 2002>2009;

CITROËN: C4 Coupe 1.4 16V 2004>2011, C4 Coupe 1.6 16V 2004>2011, C4 Coupe 1.6 HDi 2004>2011, C4 Coupe 1.6 THP 2004>2011, C4 Coupe 1.6 THP 150 2004>2011, C4 Coupe 1.6 VTi 120 2004>2011, C4 Coupe 2.0 16V 2004>2011, C4 Coupe 2.0 HDi 2004>2011, C4 Coupe 2.0 VTR 2004>2011, C4 I 1.4 16V 2004>2011, C4 I 1.6 16V 2004>2011, C4 I 1.6 16V Bio-Flex 2004>2011, C4 I 1.6 HDi 2004>2011, C4 I 1.6 THP 140 2004>2011, C4 I 1.6 THP 150 2004>2011, C4 I 1.6 VTi 120 2004>2011, C4 I 2.0 16V 2004>2011, C4 I 2.0 HDi 2004>2011, C4 I Box Body / Hatchback 2.0 HDi 2005>2010, C4 I Saloon 1.6 16V 2006>2011, C4 I Saloon 1.6 HDi 2006>2011, C4 I Saloon 2.0 16V 2006>2011, C4 I Saloon 2.0 HDi 2006>2011



GS2088 // NEW //

FRONT WHEEL SENSOR (BOTH SIDES)

REPLACES / REEMPLAZA:

Citroën: 454586, 0986594576; **Bosch:** 0 986 594 576; **Delphi:** SS20135; **Cargo:** 182316; **Meat & Doria:** 90163; **Mobiletron:** AB-EU084

APPLICATION / APLICACIÓN:

CITROËN: C5 Box Body/Estate 1.8 2002>2008, C5 Box Body/Estate 2.0 2002>2008, C5 Box Body/Estate 2.0 HDi 2002>2008, C5 Box Body/Estate 2.2 HDi 2002>2008, C5 I 1.8 16V (DC6FZB, DC6FZE) 2001>2005, C5 I 2.0 16V (DCRFNC, DCRFNF) 2001>2005, C5 I 2.0 16V HPI (DCRLZB) 2001>2005, C5 I 2.0 HDi (DCRHYB) 2001>2005, C5 I 2.0 HDi (DCRHZB, DCRHZE) 2001>2005, C5 I 2.2 HDi (DC4HXB, DC4HXE) 2001>2005, C5 I 3.0 V6 (DCXFXC, DCXFXF) 2001>2005, C5 I 3.0 V6 (DCXFXF) 2001>2005, C5 I Break 1.8 16V (DE6FZB, DE6FZE) 2001>2004, C5 I Break 2.0 16V (DERFNF, DERFNC, RERFNC) 2001>2004, C5 I Break 2.0 16V HPI (DERLZB) 2001>2004, C5 I Break 2.0 HDi (DERHSE, DERHSE) 2001>2004, C5 I Break 2.0 HDi (DERHYB) 2001>2004, C5 I Break 2.0 HDi (DERHZE, DERHZE) 2001>2004, C5 I Break 2.2 HDi (DE4HXB, DE4HXE) 2001>2004, C5 I Break 3.0 Carlsson 2001>2004, C5 I Break 3.0 V6 (DEXFXC, DEXFXF) 2001>2004, C5 II 1.6 HDi (RC8HZB) 2004>2007, C5 II 1.8 16V 2004>2007, C5 II 1.8 16V (RC6FZB) 2004>2007, C5 II 2.0 16V (RCRFJB, RCRFJC) 2004>2007, C5 II 2.0 HDi (RCRHRH) 2004>2007, C5 II 2.2 HDi 2004>2007, C5 II 2.2 HDi (RC4HXE) 2004>2007, C5 II 3.0 V6 2004>2007, C5 II 3.0 V6 (RCXFFU) 2004>2007, C5 II Break 1.6 HDi (RE8HZB) 2004>2007, C5 II Break 1.8 16V 2004>2007, C5 II Break 1.8 16V (RE6FZB) 2004>2007, C5 II Break 2.0 16V (RERFJB, RERFJC) 2004>2007, C5 II Break 2.0 HDi (RERHRH) 2004>2007, C5 II Break 2.2 HDi 2004>2007, C5 II Break 2.2 HDi (RE4HXE) 2004>2007, C5 II Break 3.0 V6 2004>2007, C5 II Break 3.0 V6 (REXFUF) 2004>2007, C5 Box Body/Estate 1.6 HDi 2002>2008, C5 III 3.0 Carlsson HP 2004>2007, C5 III Break 3.0 2004>2007, C5 III 1.6 HDi 110 2008>2014, C5 III 1.8 16V 2008>2014, C5 III 2.0 16V 2008>2014, C5 III 2.0 16V BioFlex 2008>2014, C5 III 2.0 HDi 2008>2014, C5 III 2.2 HDi 2008>2014, C5 III 2.7 HDi 2008>2014, C5 III Break 1.6 HDi 110 2008>2014, C5 III Break 1.8 16V 2008>2014, C5 III Break 2.0 16V 2008>2014, C5 III Break 2.0 16V BioFlex 2008>2014, C5 III Break 2.0 HDi 2008>2014, C5 III Break 2.2 HDi 2008>2014, C5 III Break 2.2 HDi 165 2008>2014, C5 III Break 2.7 HDi 2008>2014, C5 III Break 3.0 V6 2008>2014



GS2089 // NEW //

REAR WHEEL SENSOR (BOTH SIDES)

REPLACES / REEMPLAZA:

Citroën: 4545A5, 0986594568; **Bosch:** 0 986 594 568; **Delphi:** SS20391; **Cargo:** 181902; **Meat & Doria:** 90164

APPLICATION / APLICACIÓN:

CITROËN: C5 Box Body/Estate 2.0 2002>2008, C5 Box Body/Estate 2.0 HDi 2002>2008, C5 II 1.6 HDi (RC8HZB) 2004>2007, C5 II 1.8 16V 2004>2007, C5 II 1.8 16V (RC6FZB) 2004>2007, C5 II 2.0 16V (RCRFJB, RCRFJC) 2004>2007, C5 II 2.0 HDi (RCRHRH) 2004>2007, C5 II 2.2 HDi 2004>2007, C5 II 2.2 HDi (RC4HXE) 2004>2007, C5 II 3.0 V6 2004>2007, C5 II 3.0 V6 (RCXFFU) 2004>2007, C5 II Break 1.6 HDi (RE8HZB) 2004>2007, C5 II Break 1.8 16V 2004>2007, C5 II Break 1.8 16V (RE6FZB) 2004>2007, C5 II Break 2.0 16V (RERFJB, RERFJC) 2004>2007, C5 II Break 2.0 HDi (RERHRH) 2004>2007, C5 II Break 2.2 HDi 2004>2007, C5 II Break 2.2 HDi (RE4HXE) 2004>2007, C5 II Break 3.0 V6 2004>2007, C5 II Break 3.0 V6 (REXFUF) 2004>2007, C5 Box Body/Estate 1.6 HDi 2002>2008, C5 Box Body/Estate 1.8 2002>2008, C5 Box Body/Estate 2.2 HDi 2002>2008, C5 I 1.8 16V (DC6FZB, DC6FZE) 2001>2005, C5 I 2.0 16V (DCRFNC, DCRFNF) 2001>2005, C5 I 2.0 16V HPI (DCRLZB) 2001>2005, C5 I 2.0 HDi (DCRHYB) 2001>2005, C5 I 2.0 HDi (DCRHZB, DCRHZE) 2001>2005, C5 I 2.2 HDi (DC4HXB, DC4HXE) 2001>2005, C5 I 3.0 Carlsson HP 2001>2005, C5 I 3.0 V6 2001>2005, C5 I 3.0 V6 (DCXFXC, DCXFXF) 2001>2005, C5 I Break 1.8 16V (DE6FZB, DE6FZE) 2001>2004, C5 I Break 2.0 16V (DERFNF, DERFNC, RERFNC) 2001>2004, C5 I Break 2.0 16V HPI (DERLZB) 2001>2004, C5 I Break 2.0 HDi (DERHSE, DERHSE) 2001>2004, C5 I Break 2.0 HDi (DERHYB) 2001>2004, C5 I Break 2.0 HDi (DERHZE, DERHZE) 2001>2004, C5 I Break 2.2 HDi (DE4HXB, DE4HXE) 2001>2004, C5 I Break 3.0 Carlsson 2001>2004, C5 I Break 3.0 V6 (DEXFXC, DEXFXF) 2001>2004, C5 II 2.0 16V 2004>2007, C5 II 3.0 Carlsson HP 2004>2007, C5 II Break 3.0 2004>2007



GS2093 // NEW //
FRONT WHEEL SENSOR (BOTH SIDES)
REPLACES / REEMPLAZA:
Jeep: 56005216, 56005216AB, 56005217, 56005217AB

APPLICATION / APLICACIÓN:
JEEP: Cherokee 4.0 I 1999>2001, Grand Cherokee I 2.5 Td 4X4 1995>1999, Grand Cherokee I 2.5 Td Laredo 1996>1998, Grand Cherokee I 4.0 Laredo 1996>1998, Grand Cherokee I 4.0 I 4X4 1991>1999, Grand Cherokee I 5.2 1996>1998, Grand Cherokee I 5.2 4X4 1995>1998, Grand Cherokee I 5.2 Limited 4X4 1996>1998, Grand Cherokee I 5.2 I 4X4 1992>1999, Grand Cherokee I 5.9 I 4X4 1997>1999

GS2096 // NEW //
FRONT WHEEL SENSOR (RIGHT SIDE)
REPLACES / REEMPLAZA:
Jeep: 56041316AA, 56041316AB, 56041316AC;

Mobiletron: AB-US078

APPLICATION / APLICACIÓN:
JEEP: Grand Cherokee Ii 2.7 Crd 4X4 2001>2005, Grand Cherokee Ii 3.1 Td 4X4 1999>2001, Grand Cherokee Ii 4.0 4X4 1999>2005, Grand Cherokee Ii 4.7 V8 4X4 1999>2000

GS2097 // NEW //
FRONT WHEEL SENSOR (LEFT SIDE)
REPLACES / REEMPLAZA:
Jeep: 6041317AA, 56041317AB, 56041317AC

APPLICATION / APLICACIÓN:
JEEP: Grand Cherokee Ii 2.7 Crd 4X4 2001>2005, Grand Cherokee Ii 3.1 Td 4X4 1999>2001, Grand Cherokee Ii 4.0 4X4 1999>2005, Grand Cherokee Ii 4.7 V8 4X4 1999>2000

GS2099 // NEW //
REAR WHEEL SENSOR (BOTH SIDES)
REPLACES / REEMPLAZA:
Jeep: 5014787AA, 5014787AB, 56028187AB, 56028187A,

56028187AD, 56028187AE, 56028229AB; Mobiletron:
AB-US005
APPLICATION / APLICACIÓN:
DODGE: Dakota 2.5 1995>2003, Dakota 3.9 AWD 1995>2003, Dakota 3.9 SLT 1995>2003, Dakota 4.7 AWD 1995>2003, Durango 4.7 4WD 1997>2003, Durango 5.2 1997>2003

GS2100
REPLACES / REEMPLAZA:
Isuzu: 8971188100, 8970752940, 8943300350, 8943300351, 8943300352, 8943300353, 8971155580

APPLICATION / APLICACIÓN:
Isuzu: Amigo, Rodeo, Tropper

Honda: Passport

GS2101 // NEW //
REAR WHEEL SENSOR (BOTH SIDES)
REPLACES / REEMPLAZA:
BMW: 34526757281; **Bosch:** 0 986 594 532; **Delphi:** SS20544; **Meat & Doria:** 90193; **Mobiletron:** AB-EU288

APPLICATION / APLICACIÓN:
BMW: Z4 Coupe 3.0 si 2006>2009, Z4 Coupe M 2006>2009, Z4 Roadster 2.0 i 2002>2009, Z4 Roadster 2.2 i 2002>2009, Z4 Roadster 2.5 i 2002>2009, Z4 Roadster 2.5 si 2002>2009, Z4 Roadster 3.0 i 2002>2009, Z4 Roadster 3.0 si 2002>2009, Z4 Roadster M 2002>2009, Z4 Coupe 2.5 i 2006>2009, Z4 Roadster 3.2 2002>2009

GS2102
FRONT WHEEL SENSOR (LEFT SIDE)
REPLACES / REEMPLAZA:
Bosch: 0 265 007 102

Fiat: 46783183

APPLICATION / APLICACIÓN:
Fiat: Palio Hatch, Palio Weekend, Strada Pickup

GS2103 // NEW //
FRONT WHEEL SENSOR (RIGHT SIDE)
REPLACES / REEMPLAZA:
Fiat: 46783184

APPLICATION / APLICACIÓN:
Fiat: Palio Hatch 1.2 1997>2002, Palio Weekend 1.2/1.9 1997>, Strada Pickup 1.2/1.3 2003>

PS: set of GS2102

GS2104 // NEW //
FRONT WHEEL SENSOR (RIGHT SIDE)
REPLACES / REEMPLAZA:
Jeep: 4683470AB, 4683470A, 4683470AD, 4683470AE, 4683470AF; **Delphi:** SS20394; **Mobiletron:** AB-US003

APPLICATION / APLICACIÓN:
CHRYSLER: Voyager IV 2.4 1999>2008, Voyager IV 2.5 CRD 1999>2008, Voyager IV 2.8 CRD 1999>2008, Voyager IV 3.0 1999>2008, Voyager IV 3.3 1999>2008, Voyager IV 3.3 AWD 1999>2008, Voyager IV 3.3 Flexfuel 1999>2008, Voyager IV 3.3 Flexfuel AWD 1999>2008, Voyager IV 3.8 1999>2008, Voyager IV 3.8 AWD 1999>2008

GS2105 // NEW //
REAR WHEEL SENSOR (BOTH SIDES)
REPLACES / REEMPLAZA:
Jeep: 4721040AB, 5066353AA, 5086651AA; **Meat & Doria:** 90344E

APPLICATION / APLICACIÓN:
CHRYSLER: Voyager IV 2.4 1999>2008, Voyager IV 2.5 CRD 1999>2008, Voyager IV 2.8 CRD 1999>2008, Voyager IV 3.3 1999>2008

GS2106 // NEW //
FRONT WHEEL SENSOR (BOTH SIDES)
REPLACES / REEMPLAZA:
Jeep: 68128181AA, 68128181AB, 68128181AC

APPLICATION / APLICACIÓN:
LANCIA: Voyager Monovolume 2.8 Crd 2011>2014, Voyager Monovolume 3.6 V6 2011>2014

GS2107 // NEW //
REAR WHEEL SENSOR (BOTH SIDES)
REPLACES / REEMPLAZA:
Jeep: 68127990AA, 68127990AB, 68127990AD

APPLICATION / APLICACIÓN:
LANCIA: Voyager Monovolume 2.8 Crd 2011>2014, Voyager Monovolume 3.6 V6 2011>2014



GS2108 // NEW //
REAR WHEEL SENSOR (BOTH SIDES)
REPLACES / REEMPLAZA:
Jeep: 5154230AA, 5154230AB, 5154230AC, 5154230AD, 5154230AE, 5154230AF; **A.B.S:** 31362

APPLICATION / APLICACIÓN:
JEEP: Grand Cherokee Iv 3.0 4X4 2014>0, Grand Cherokee Iv 3.0 Crd V6 4X4 2011>0, Grand Cherokee Iv 3.6 V6 2010>0, Grand Cherokee Iv 3.6 V6 4X4 2010>0, Grand Cherokee Iv 3.6 V6 Flexfuel 4X4 2010>0, Grand Cherokee Iv 3.6 Vvt 4X4 2016>0, Grand Cherokee Iv 5.7 4X4 2011>0, Grand Cherokee Iv 5.7 V8 4X4 2010>0, Grand Cherokee Iv 6.2 I V8 4X4 2017>0, Grand Cherokee Iv 6.4 Srt8 4X4 2011>0

GS2109 // NEW //
FRONT WHEEL SENSOR (BOTH SIDES)
REPLACES / REEMPLAZA:
Jeep: 56029447AE, 56029447AF; **Meat & Doria:** 90882E

APPLICATION / APLICACIÓN:
DODGE: Durango 3.6 2011>0, Durango 3.6 Awd 2011>0, Durango 5.7 2011>0, Durango 5.7 Awd 2011>0 **JEEP:** Grand Cherokee Iv 3.0 Crd 2013>0, Grand Cherokee Iv 3.0 Crd V6 4X4 2011>0, Grand Cherokee Iv 3.6 V6 4X4 2010>0, Grand Cherokee Iv 3.6 V6 Flexfuel 4X4 2010>0, Grand Cherokee Iv 5.7 V8 4X4 2010>0, Grand Cherokee Iv 6.4 Srt8 4X4 2011>0

GS2110 // NEW //
FRONT WHEEL SENSOR (BOTH SIDES)
REPLACES / REEMPLAZA:
Jeep: 4779639AA, 4779639AB, 4779639AD; **Mobiletron:** AB-US054

APPLICATION / APLICACIÓN:
CHRYSLER: 300C 3.0 CRD 2011>1900, 300C 3.6 2011>1900, 300C 6.4 2011>1900

GS2111 // NEW //
REAR WHEEL SENSOR (RIGHT SIDE)
REPLACES / REEMPLAZA:
Jeep: 4779642AA, 4779642AC; **Mobiletron:** AB-US055

APPLICATION / APLICACIÓN:
CHRYSLER: 300C 3.0 CRD 2011>1900, 300C 3.6 2011>1900, 300C 6.4 2011>1900

GS2113
FRONT WHEEL SENSOR
REPLACES / REEMPLAZA:
Bosch: 0 986 594 030

Renault: 7700429113, 7700 832 768

APPLICATION / APLICACIÓN:
Renault: Megane Grandtour, Scenic

GS2114 // NEW //
FRONT WHEEL SENSOR (BOTH SIDES)
REPLACES / REEMPLAZA:
Citroën: 96217759, 454547, 96087509, 454535, 96180488, 0265006199, 0265003128, 0265003078; **Delphi:** SS20048;

Hitachi: 131561; **Mobiletron:** AB-EU177

APPLICATION / APLICACIÓN:
CITROËN: ZX 1.1 1991>1997, ZX 1.1 1991>1997, ZX 1.4 1991>1997, ZX 1.4 D 1991>1997, ZX 1.4 i 1991>1997, ZX 1.6 1991>1997, ZX 1.6 i 1991>1997, ZX 1.8 1991>1997, ZX 1.8 D 1991>1997, ZX 1.8 i 1991>1997, ZX 1.8 i 16V 1991>1997, ZX 1.9 1991>1997, ZX 1.9 D 1991>1997, ZX 1.9 DT 1991>1997, ZX 1.9 i 1991>1997, ZX 1.9 TD 1991>1997, ZX 2.0 1991>1997, ZX 2.0 i 1991>1997, ZX 2.0 i 16V 1991>1997, ZX Break 1.4 i 1993>1998, ZX Break 1.6 i 1993>1998, ZX Break 1.8 D 1993>1998, ZX Break 1.8 i 1993>1998, ZX Break 1.8 i 16V 1993>1998, ZX Break 1.9 D 1993>1998, ZX Break 1.9 TD 1993>1998

GS2115
FRONT WHEEL SENSOR (RIGHT SIDE)
REPLACES / REEMPLAZA:
Toyota: 8954252030, 8954252050

APPLICATION / APLICACIÓN:
Toyota: Yaris Mk2 hatch, Urban Cruiser

GS2120 // NEW //
FRONT WHEEL SENSOR (BOTH SIDES)
REPLACES / REEMPLAZA:
Jeep: 4779244AA, 4779244AB, 4779244A, 4779244AD

APPLICATION / APLICACIÓN:
CHRYSLER: 300 C 3.0 Crd 2005>2012, 300 C 3.0 V6 Crd 2010>2012, 300 C 3.5 2004>2012, 300 C 5.7 2004>2008, 300 C 6.1 Srt8 2005>2012, 300 C Touring 3.0 Crd 2005>2010, 300 C Touring 3.5 2004>2010, 300 C Touring 3.5 Awd 2004>2010, 300 C Touring 5.7 2004>2010, 300 C Touring 5.7 Awd 2005>2010, 300 C Touring 6.1 Srt8 2005>2010

GS2121 // NEW //
REAR WHEEL SENSOR (RIGHT SIDE)
REPLACES / REEMPLAZA:
Jeep: 4779246AA, 4779246AB, 4779246AC, 4779246AD, 4779456AA, 4779456AB; **Meat & Doria:** 90886E

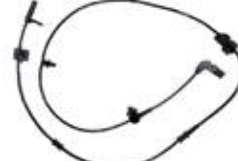
APPLICATION / APLICACIÓN:
CHRYSLER: 300 C 2.7 2004>0, 300 C 3.0 Crd 2005>0, 300 C 3.0 V6 Crd 2010>0, 300 C 3.5 2004>0, 300 C 3.5 Awd 2004>0, 300 C 5.7 2004>0, 300 C 6.1 Srt8 2005>0, 300 C Touring 2.7 2004>0, 300 C Touring 3.0 Crd 2005>0, 300 C Touring 3.5 2004>0, 300 C Touring 3.5 Awd 2004>0, 300 C Touring 5.7 2004>0, 300 C Touring 5.7 Awd 2005>0, 300 C Touring 6.1 Srt8 2005>0 **DODGE:** Challenger Coupe 3.5 2004>0, Challenger Coupe 5.7 2004>0, Challenger Coupe 6.1 Srt8 2005>0, Charger 2.7 2004>0, Charger 3.5 2004>0, Charger 5.7 R/T 2005>0, Charger 6.1 Srt8 2005>0

GS2122 // NEW //
REAR WHEEL SENSOR (RIGHT SIDE)
REPLACES / REEMPLAZA:
Jeep: 4779247AA, 4779247AB, 4779247AC, 4779247AD, 4779457AA, 4779457AB; **Meat & Doria:** 90885E

APPLICATION / APLICACIÓN:
CHRYSLER: 300 C 2.7 2004>0, 300 C 3.0 Crd 2005>0, 300 C 3.0 V6 Crd 2010>0, 300 C 3.5 2004>0, 300 C 3.5 Awd 2004>0, 300 C 5.7 2004>0, 300 C 6.1 Srt8 2005>0, 300 C Touring 2.7 2004>0, 300 C Touring 3.0 Crd 2005>0, 300 C Touring 3.5 2004>0, 300 C Touring 3.5 Awd 2004>0, 300 C Touring 5.7 2004>0, 300 C Touring 5.7 Awd 2005>0, 300 C Touring 6.1 Srt8 2005>0 **DODGE:** Challenger Coupe 3.5 2004>0, Challenger Coupe 5.7 2004>0, Challenger Coupe 6.1 Srt8 2005>0, Charger 2.7 2004>0, Charger 3.5 2004>0, Charger 5.7 R/T 2005>0, Charger 6.1 Srt8 2005>0

GS2123 // NEW //
REAR WHEEL SENSOR (BOTH SIDES)
REPLACES / REEMPLAZA:
Jeep: 5032220AA, 5032220AB

APPLICATION / APLICACIÓN:
CHRYSLER Dodge Jeep Dakota 2005>2010, Durango 2004>2006, RAM 2500 Pic 2006>2010, RAM 3500 Pic 2006>2010

GS2125 // NEW //
FRONT WHEEL SENSOR (BOTH SIDES)
REPLACES / REEMPLAZA:
Jeep: 68003281AA, 68003281AB, 68003281AC; **Meat & Doria:** 90877E; **Mobiletron:** AB-US071

APPLICATION / APLICACIÓN:
JEEP: Wrangler III 2.8 CRD 2007>2011, Wrangler III 3.6 V6 2007>2011, Wrangler III 3.8 2007>2011, Wrangler III 3.8 RWD 2007>2011

GS2126 // NEW //
REAR WHEEL SENSOR (BOTH SIDES)
REPLACES / REEMPLAZA:
Jeep: 52125003AA, 52125003AB; **Mobiletron:** AB-US058

APPLICATION / APLICACIÓN:
JEEP: CHEROKEE 2.8 CRD 4x4 2008>2013, CHEROKEE 3.7 V6 2008>2013, CHEROKEE 3.7 V6 4x4 2008>2013, CHEROKEE 3.7 V6 All-wheel Drive 2008>2013, WRANGLER III 2.8 CRD 2007>2011, WRANGLER III 3.6 V6 2007>2011, WRANGLER III 3.8 2007>2011, WRANGLER III 3.8 RWD 2007>2011;

DODGE: NITRO 2.8 CRD 2006>2012, NITRO 2.8 CRD 4WD 2006>2012, NITRO 3.7 2006>2012, NITRO 3.7 4WD 2006>2012, NITRO 3.7 V6 4WD 2006>2012, NITRO 4.0 4WD 2006>2012

GS2127 // NEW //
FRONT WHEEL SENSOR (RIGHT SIDE)
REPLACES / REEMPLAZA:
Mitsubishi: 5085822AB, 5085822AD, 05105572AA, K05085822A, 4670A032, 4670A576; **Mobiletron:** AB-US053

APPLICATION / APLICACIÓN:
DODGE: Journey 2.0 CRD 2008>2015, Journey 2.4 2008>2015, Journey 2.4 ECO+ 2008>2015, Journey 2.7 2008>2015, Journey 2.7 flexfuel 2008>2015, Journey 3.5 2008>2015, Journey 3.5 AWD 2008>2015, Journey 3.6 2008>2015;

CHRYSLER: Sebring 2.0 CRD 2006>2010, Sebring 2.0 VVT 2006>2010, Sebring 2.4 VVT 2006>2010, Sebring 2.7 2006>2010, Sebring 2.7 VVT 2006>2010, Sebring 3.5 2006>2010, Sebring Convertible 2.0 CRD 2007>2010, Sebring Convertible 2.4 VVT 2007>2010, Sebring Convertible 2.7 2007>2010, Sebring Convertible 2.7 Flexfuel 2007>2010, Sebring Convertible 2.7 VVT 2007>2010, Sebring Convertible 3.5 2007>2010

GS2128 // NEW //
FRONT WHEEL SENSOR (LEFT SIDE)
REPLACES / REEMPLAZA:
Mitsubishi: 085823AB, 5085823AC, 5105573AA, 5105573AB, 4670A031, 4670A575, 5085823AC; **A.B.S:** 31810

APPLICATION / APLICACIÓN:
CHRYSLER: Sebring 2.0 Crd 2007>2010, Sebring 2.0 Vvt 2007>2010, Sebring 2.7 2007>2010, Sebring 2.7 Vvt 2007>2010, Sebring Conversivel 2.0 Crd 2007>2010, Sebring Conversivel 2.4 Vvt 2007>2010, Sebring Conversivel 2.7 2007>2010;

DODGE: Journey 2.0 Crd 2008>, Journey 2.4 2009>, Journey 2.4 Eco+ 2008>, Journey 2.7 2009>, Journey 3.5 Awd 2008>, Journey 3.6 2012>

GS2130 // NEW //
FRONT WHEEL SENSOR (BOTH SIDES)
REPLACES / REEMPLAZA:
Jeep: 56044144AA, 56044144AB, 56044144AJ, 56044144AD; **Meat & Doria:** 90868E

APPLICATION / APLICACIÓN:
JEEP: Commander 3.0 Crd 4x4 2006>2010, Commander 3.7 V6 4x4 2005>2010, Grand Cherokee li 4.7 V8 4x4 1999>2005, Grand Cherokee lii 3.0 Crd 4x4 2005>2010, Grand Cherokee lii 3.7 V6 4x4 2004>2010, Grand Cherokee lii 4.7 V8 4x4 2007>2010, Grand Cherokee lii 5.7 V8 4x4 2005>2010, Grand Cherokee lii 6.1 Srt8 4x4 2006>2010, Grand Cherokee Iv 3.6 V6 4x4 2010>, Grand Cherokee Iv 3.6 V6 Flexfuel 4x4 2010>, Grand Cherokee Iv 5.7 V8 4x4 2010>

GS2131 // NEW //
REAR WHEEL SENSOR (BOTH SIDES)
REPLACES / REEMPLAZA:
Jeep: 56044146AA, 56044146AB; **Meat & Doria:** 90881E; **Mobiletron:** AB-US069

APPLICATION / APLICACIÓN:
JEEP: Commander 3.0 CRD 4x4 2005>2010, Commander 3.7 V6 4x4 2005>2010, Commander 4.7 V8 4x4 2005>2010, Commander 5.7 HEMI 4x4 2005>2010, Commander 5.7 V8 4x4 2005>2010, Grand Cherokee III 3.0 CRD 2004>2010, Grand Cherokee III 3.0 CRD 4x4 2004>2010, Grand Cherokee III 3.7 V6 2004>2010, Grand Cherokee III 3.7 V6 4x4 2004>2010, Grand Cherokee III 4.7 V8 2004>2010, Grand Cherokee III 4.7 V8 4x4 2004>2010, Grand Cherokee III 4.7 V8 FLEX 2004>2010, Grand Cherokee III 5.7 2004>2010, Grand Cherokee III 5.7 V8 4x4 2004>2010, Grand Cherokee III 6.1 SRT8 4x4 2004>2010, Grand Cherokee III 6.1 SRT8 RWD 2004>2010

GS2132 // NEW //
FRONT WHEEL SENSOR (BOTH SIDES)
REPLACES / REEMPLAZA:
Fiat: 68246922AA, 52027751

APPLICATION / APLICACIÓN:
CHRYSLER DODGE JEEP Renegade 2015>2017, **FIAT** Toro 4x2 / 4x4 2017>

GS2146 // NEW //
FRONT WHEEL SENSOR (LEFT SIDE)
REPLACES / REEMPLAZA:
Fiat: 46740217, 46811205, 517117167, 0986594578; **Bosch:** 0 986 594 578; **Delphi:** SS20482; **Meat & Doria:** 90166; **Mobiletron:** AB-EU123

APPLICATION / APLICACIÓN:
FIAT: Doblò Box Body/Estate 1.4 Flex 2014>1900, Doblò Cargo 1.2 (223ZX1A) 2000>2010, Doblò Cargo 1.2 16V 2000>2010, Doblò Cargo 1.3 D Multijet 2000>2010, Doblò Cargo 1.3 JTD 16V 2000>2010, Doblò Cargo 1.3 JTD 16V Multijet 2000>2010, Doblò Cargo 1.4 2000>2010, Doblò Cargo 1.4 Flexfuel 2000>2010, Doblò Cargo 1.6 16V 2000>2010, Doblò Cargo 1.6 16V (223XD1A) 2000>2010, Doblò Cargo 1.6 Natural Power 2000>2010, Doblò Cargo 1.6 Natural Power (223WXD1A) 2000>2010, Doblò Cargo 1.8 2000>2010, Doblò Cargo 1.8 Flexfuel 2000>2010, Doblò Cargo 1.9 D (223ZXB1A) 2000>2010, Doblò Cargo 1.9 JTD 2000>2010, Doblò Cargo 1.9 JTD (223ZXE1A) 2000>2010, Doblò Cargo 1.9 JTD Multijet 2000>2010, Doblò MPV 1.2 (223AXA1A) 2001>2013, Doblò MPV 1.2 16V 2001>2013, Doblò MPV 1.3 D Multijet 2001>2013, Doblò MPV 1.3 JTD 2001>2013, Doblò MPV 1.3 JTD 16V 2001>2013, Doblò MPV 1.4 2001>2013, Doblò MPV 1.4 Flex (119107, 119307) 2001>2013, Doblò MPV 1.6 2001>2013, Doblò MPV 1.6 16V (223AXD1A) 2001>2013, Doblò MPV 1.6 Natural Power 2001>2013, Doblò MPV 1.6 Natural Power (223AXD1A) 2001>2013, Doblò MPV 1.8 2001>2013, Doblò MPV 1.8 MPI Flex (1196091) 2001>2013, Doblò MPV 1.9 D (223AXB1A) 2001>2013, Doblò MPV 1.9 D Multijet 2001>2013, Doblò MPV 1.9 JTD 2001>2013, Doblò MPV 1.9 JTD (223AXE1A) 2001>2013, Doblò MPV 1.6 16V 2001>2013, Doblò MPV 1.8 Flex 2001>2013



GS2147 // NEW //

FRONT WHEEL SENSOR (RIGHT SIDE)

REPLACES / REEMPLAZA:

Fiat: 46740213, 0986594577; **Bosch:** 0 986 594 577; **Delphi:** SS20483; **Cargo:** 182327; **Meat & Doria:** 90165; **Mobiletron:** AB-EU099

APPLICATION / APLICACIÓN:

FIAT: Doblò Box Body/Estate 1.4 Flex 2014>1900, Doblò Cargo 1.2 (223ZXA1A) 2000>2010, Doblò Cargo 1.2 16V 2000>2010, Doblò Cargo 1.3 D Multijet 2000>2010, Doblò Cargo 1.3 JTD 16V 2000>2010, Doblò Cargo 1.3 JTD 16V Multijet 2000>2010, Doblò Cargo 1.4 2000>2010, Doblò Cargo 1.4 Flexfuel 2000>2010, Doblò Cargo 1.6 16V 2000>2010, Doblò Cargo 1.6 16V (223ZXD1A) 2000>2010, Doblò Cargo 1.6 Natural Power 2000>2010, Doblò Cargo 1.6 Natural Power (223WXD1A) 2000>2010, Doblò Cargo 1.8 2000>2010, Doblò Cargo 1.8 Flexfuel 2000>2010, Doblò Cargo 1.9 D (223ZXB1A) 2000>2010, Doblò Cargo 1.9 JTD 2000>2010, Doblò Cargo 1.9 JTD (223ZXE1A) 2000>2010, Doblò Cargo 1.9 JTD Multijet 2000>2010, Doblò MPV 1.2 (223AXA1A) 2001>2013, Doblò MPV 1.2 16V 2001>2013, Doblò MPV 1.3 D Multijet 2001>2013, Doblò MPV 1.3 JTD 2001>2013, Doblò MPV 1.3 JTD 16V 2001>2013, Doblò MPV 1.4 2001>2013, Doblò MPV 1.4 Flex (119107, 119307) 2001>2013, Doblò MPV 1.6 2001>2013, Doblò MPV 1.6 16V (223AXD1A) 2001>2013, Doblò MPV 1.6 Natural Power 2001>2013, Doblò MPV 1.6 Natural Power (223AXD1A) 2001>2013, Doblò MPV 1.8 2001>2013, Doblò MPV 1.8 MPI Flex (1196091) 2001>2013, Doblò MPV 1.9 D (223AXB1A) 2001>2013, Doblò MPV 1.9 D Multijet 2001>2013, Doblò MPV 1.9 JTD 2001>2013, Doblò MPV 1.9 JTD (223AXE1A) 2001>2013, Doblò MPV 1.6 16V 2001>2013, Doblò MPV 1.8 Flex 2001>2013



GS2148 // NEW //

REAR WHEEL SENSOR (BOTH SIDES)

REPLACES / REEMPLAZA:

Fiat: 46814966, 51717165, 0986594579, 0986594583, 46814965; **Bosch:** 0 986 594 583; **Meat & Doria:** 90168; **Mobiletron:** AB-EU367

APPLICATION / APLICACIÓN:

FIAT: Doblò Cargo 1.2 (223ZXA1A) 2000>2010, Doblò Cargo 1.3 D Multijet 2000>2010, Doblò Cargo 1.3 JTD 16V 2000>2010, Doblò Cargo 1.3 JTD 16V Multijet 2000>2010, Doblò Cargo 1.4 2000>2010, Doblò Cargo 1.6 16V (223ZXD1A) 2000>2010, Doblò Cargo 1.6 Natural Power 2000>2010, Doblò Cargo 1.6 Natural Power (223WXD1A) 2000>2010, Doblò Cargo 1.9 D (223ZXB1A) 2000>2010, Doblò Cargo 1.9 JTD 2000>2010, Doblò Cargo 1.9 JTD (223ZXE1A) 2000>2010, Doblò Cargo 1.9 JTD Multijet 2000>2010, Doblò MPV 1.3 JTD 2001>2013, Doblò MPV 1.4 2001>2013, Doblò MPV 1.2 (223AXA1A) 2001>2013, Doblò MPV 1.3 D Multijet 2001>2013, Doblò MPV 1.6 16V (223AXD1A) 2001>2013, Doblò MPV 1.6 Natural Power 2001>2013, Doblò MPV 1.9 D (223AXB1A) 2001>2013, Doblò MPV 1.9 D Multijet 2001>2013, Doblò MPV 1.9 JTD 2001>2013, Doblò MPV 1.9 JTD (223AXE1A) 2001>2013



GS2149 // NEW //

FRONT WHEEL SENSOR (BOTH SIDES)

REPLACES / REEMPLAZA:

Fiat: 51725099, K04727624AA, 0265007685; **Bosch:** 0 265 007 685; **Delphi:** SS20129; **Meat & Doria:** 90270; **Mobiletron:** AB-EU159

APPLICATION / APLICACIÓN:

FIAT: Ducato Box 100 Multijet 2,2 D 2006>2014, Ducato Box 110 Multijet 2,3 D 2006>2014, Ducato Box 115 Multijet 2,0 D 2006>2014, Ducato Box 120 Multijet 2,3 D 2006>2014, Ducato Box 120 Multijet 2,3 D 4x4 2006>2014, Ducato Box 130 Multijet 2,3 D 2006>2014, Ducato Box 130 Multijet 2,3 D 4x4 2006>2014, Ducato Box 140 Multijet 2,3 D 2006>2014, Ducato Box 140 Multijet 3,0 D 2006>2014, Ducato Box 140 Natural Power 2006>2014, Ducato Box 150 Multijet 2,3 D 2006>2014, Ducato Box 150 Multijet 2,3 D 4x4 2006>2014, Ducato Box 150 Multijet 3,0 D 2006>2014, Ducato Box 160 Multijet 2,3 D 2006>2014, Ducato Box 160 Multijet 2,3 D 4x4 2006>2014, Ducato Box 160 Multijet 3,0 D 2006>2014, Ducato Box 180 Multijet 2,3 D 2006>2014, Ducato Box 180 Multijet 3,0 D 2006>2014, Ducato Bus 100 Multijet 2,2 D 2006>2014, Ducato Bus 110 Multijet 2,3 D 2006>2014, Ducato Bus 115 Multijet 2,0 D 2006>2014, Ducato Bus 120 Multijet 2,3 D 2006>2014, Ducato Bus 130 Multijet 2,3 D 2006>2014, Ducato Bus 130 Multijet 2,3 D 4x4 2006>2014, Ducato Bus 140 Multijet 2,3 D 2006>2014, Ducato Bus 140 Multijet 3,0 D 2006>2014, Ducato Bus 140 Natural Power 2006>2014, Ducato Bus 150 Multijet 2,3 D 2006>2014, Ducato Bus 150 Multijet 2,3 D 4x4 2006>2014, Ducato Bus 150 Multijet 3,0 D 2006>2014, Ducato Bus 160 Multijet 2,3 D 2006>2014, Ducato Bus 160 Multijet 3,0 D 4x4 2006>2014, Ducato Bus 180 Multijet 2,3 D 2006>2014, Ducato Bus 180 Multijet 3,0 D 2006>2014, Ducato Platparam/Chassis 100 Multijet 2,2 D 2006>2014, Ducato Platparam/Chassis 110 Multijet 2,3 D 2006>2014, Ducato Platparam/Chassis 115 Multijet 2,0 D 2006>2014, Ducato Platparam/Chassis 120 Multijet 2,3 D 2006>2014, Ducato Platparam/Chassis 120 Multijet 2,3 D 4x4 2006>2014, Ducato Platparam/Chassis 130 Multijet 2,3 D 2006>2014, Ducato Platparam/Chassis 140 Multijet 2,3 D 2006>2014, Ducato Platparam/Chassis 140 Multijet 3,0 D 2006>2014, Ducato Platparam/Chassis 140 Natural Power 2006>2014, Ducato Platparam/Chassis 150 Multijet 2,3 D 2006>2014, Ducato Platparam/Chassis 150 Multijet 3,0 D 2006>2014, Ducato Platparam/Chassis 160 Multijet 2,3 D 2006>2014, Ducato Platparam/Chassis 160 Multijet 3,0 D 2006>2014, Ducato Platparam/Chassis 180 Multijet 3,0 D 2006>2014, Ducato Box 2.0 JTD 2002>1900, Ducato Box 2.3 JTD 2002>1900, Ducato Bus 2.0 JTD 2002>1900, Ducato Bus 2.3 JTD 2002>1900, PEUGEOT: Boxer Box 2.0 BlueHDi 110 2006>2019, Boxer Box 2.0 BlueHDi 130 2006>2019, Boxer Box 2.0 BlueHDi 160 2006>2019, Boxer Box 2.2 BlueHDi 120 2006>2019, Boxer Box 2.2 BlueHDi 140 2006>2019, Boxer Box 2.2 BlueHDi 165 2006>2019, Boxer Box 2.2 HDi 100 2006>2019, Boxer Box 2.2 HDi 110 2006>2019, Boxer Box 2.2 HDi 120 2006>2019, Boxer Box 2.2 HDi 130 2006>2019, Boxer Box 2.2 HDi 150 2006>2019, Boxer Box 3.0 HDi 2006>2019, Boxer Box 3.0 HDi 145 2006>2019, Boxer Box 3.0 HDi 160 2006>2019, Boxer Box 3.0 HDi 175 2006>2019, Boxer Box 2.2 HDi 2002>1900, Boxer Bus 2.0 BlueHDi 110 2006>2019, Boxer Bus 2.0 BlueHDi 130 2006>2019, Boxer Bus 2.0 BlueHDi 160 2006>2019, Boxer Bus 2.2 BlueHDi 120 2006>2019, Boxer Bus 2.2 BlueHDi 140 2006>2019, Boxer Bus 2.2 HDi 100 2006>2019, Boxer Bus 2.2 HDi 110 2006>2019, Boxer Bus 2.2 HDi 120 2006>2019, Boxer Bus 2.2 HDi 130 2006>2019, Boxer Bus 2.2 HDi 150 2006>2019, Boxer Bus 3.0 HDi 145 2006>2019, Boxer Bus 3.0 HDi 160 2006>2019, Boxer Bus 3.0 HDi 175 2006>2019, Boxer Bus 2.2 HDi 2002>1900, Boxer Platparam/Chassis 2.0 BlueHDi 110 2006>2019, Boxer Platparam/Chassis 2.0 BlueHDi 130 2006>2019, Boxer Platparam/Chassis 2.0 BlueHDi 160 2006>2019, Boxer Platparam/Chassis 2.2 HDi 100 2006>2019, Boxer Platparam/Chassis 2.2 HDi 110 2006>2019, Boxer Platparam/Chassis 2.2 HDi 120 2006>2019, Boxer Platparam/Chassis 2.2 HDi 130 2006>2019, Boxer Platparam/Chassis 2.2 HDi 150 2006>2019, Boxer Platparam/Chassis 3.0 HDi 2006>2019, Boxer Platparam/Chassis 3.0 HDi 145 2006>2019, Boxer Platparam/Chassis 3.0 HDi 160 2006>2019, Boxer Platparam/Chassis 3.0 HDi 175 2006>2019, Boxer Platparam/Chassis 2.2 HDi 2002>1900;

CITROËN: Jumper Box 2.0 BlueHDi 110 2006>2019, Jumper Box 2.0 BlueHDi 130 2006>2019, Jumper Box 2.0 BlueHDi 160 2006>2019, Jumper Box 2.2 HDi 100 2006>2019, Jumper Box 2.2 HDi 110 2006>2019, Jumper Box 2.2 HDi 120 2006>2019, Jumper Box 2.2 HDi 130 2006>2019, Jumper Box 2.2 HDi 150 2006>2019, Jumper Box 3.0 HDi 145 2006>2019, Jumper Box 3.0 HDi 155 2006>2019, Jumper Box 3.0 HDi 160 2006>2019, Jumper Box 3.0 HDi 180 2006>2019, Jumper Box 2.2 HDi 2002>1900, Jumper Bus 2.0 BlueHDi 110 2006>2019, Jumper Bus 2.0 BlueHDi 130 2006>2019, Jumper Bus 2.0 BlueHDi 160 2006>2019, Jumper Bus 2.2 HDi 100 2006>2019, Jumper Bus 2.2 HDi 110 2006>2019, Jumper Bus 2.2 HDi 120 2006>2019, Jumper Bus 2.2 HDi 130 2006>2019, Jumper Bus 2.2 HDi 150 2006>2019, Jumper Bus 3.0 HDi 155 2006>2019, Jumper Bus 3.0 HDi 160 2006>2019, Jumper Bus 3.0 HDi 180 2006>2019, Jumper Bus 2.2 HDi 2002>1900, Jumper Platparam/Chassis 2.0 BlueHDi 110 2006>2019, Jumper Platparam/Chassis 2.0 BlueHDi 130 2006>2019, Jumper Platparam/Chassis 2.0 BlueHDi 130 4x4 2006>2019, Jumper Platparam/Chassis 2.0 BlueHDi 160 2006>2019, Jumper Platparam/Chassis 2.2 HDi 100 2006>2019, Jumper Platparam/Chassis 2.2 HDi 110 2006>2019, Jumper Platparam/Chassis 2.2 HDi 120 2006>2019, Jumper Platparam/Chassis 2.2 HDi 130 2006>2019, Jumper Platparam/Chassis 2.2 HDi 150 2006>2019, Jumper Platparam/Chassis 3.0 HDi 145 2006>2019, Jumper Platparam/Chassis 3.0 HDi 160 2006>2019, Jumper Platparam/Chassis 3.0 HDi 180 2006>2019, Jumper Platparam/Chassis 2.2 HDi 2002>1900

GS2150
FRONT WHEEL SENSOR (RIGHT SIDE)

REPLACES / REEMPLAZA:

Hyundai: 95670-2D100, 95670-2D150

Kia: 95670-2D100, 95670-2D150

APPLICATION / APLICACIÓN:

Hyundai: Elantra 1.6/2.0

Kia: Cerato 1.5/1.6/2.0

PS: set of GS2590

GS2151 // NEW //
REAR WHEEL SENSOR (BOTH SIDES)

REPLACES / REEMPLAZA:

Mitsubishi: 5105064AA, 5105064AB, MN116248, 4670A582;

Meat & Doria: 90872E

APPLICATION / APLICACIÓN:

DODGE: Caliber 1.8 2006>0, Caliber 2.0 2006>0, Caliber 2.0 Crd 2006>0, Caliber 2.2 Crd 2010>0, Caliber 2.4 2006>0, Caliber 2.4 Awd 2006>0, Caliber 2.4 Turbo 2007>0 JEEP: Compass 2.0 2006>0, Compass 2.0 Crd 2006>0, Compass 2.0 Crd 4X4 2006>0, Compass 2.2 Crd 2010>0, Compass 2.2 Crd 4X4 2010>0, Compass 2.4 2006>0, Compass 2.4 4X4 2006>0, Patriot 2.0 2006>0, Patriot 2.0 4X4 2007>0, Patriot 2.0 Crd 2006>0, Patriot 2.0 Crd 4X4 2006>0, Patriot 2.2 Crd 2010>0, Patriot 2.2 Crd 4X4 2010>0, Patriot 2.4 2006>0, Patriot 2.4 4X4 2006>0, Patriot 2.4 Eco + 4X4 2008>0

GS2152 // NEW //
FRONT WHEEL SENSOR (BOTH SIDES)

REPLACES / REEMPLAZA:

Jeep: 5179958AA, 5179958AB

APPLICATION / APLICACIÓN:

CHRYSLER Dodge Jeep RAM 2500 Pic 2006>2010, RAM 3500 Pic 2006>2010

GS2156 // NEW //
REAR WHEEL SENSOR (LEFT SIDE)

REPLACES / REEMPLAZA:

Renault: 479005846R; **Bosch:** 0 986 594 651

APPLICATION / APLICACIÓN:

DACIA: Logan li 1.0 Sce 75 2016>0, Logan li 1.2 2012>0, Logan li 1.2 Lpg 2012>0, Logan li 1.5 Blue Dci 95 2018>0, Logan li 1.5 Dci 2009>0, Logan li 1.5 Dci / Blue Dci 75 2012>0, Logan li 1.6 2012>0, Logan li Tce 90 2012>0, Logan li Tce 90 Lpg 2015>0, Logan Mcv li 1.0 Sce 75 2016>0, Logan Mcv li 1.2 2012>0, Logan Mcv li 1.2 Lpg 2012>0, Logan Mcv li 1.5 Blue Dci 95 2018>0, Logan Mcv li 1.5 Dci 2009>0, Logan Mcv li 1.6 2012>0, Logan Mcv li Tce 90 2012>0, Logan Mcv li Tce 90 Lpg 2015>0, Sandero li 1.0 Sce 75 2016>0, Sandero li 1.2 2012>0, Sandero li 1.2 Lpg 2012>0, Sandero li 1.5 Blue Dci 95 2018>0, Sandero li 1.5 Dci 2009>0, Sandero li 1.5 Dci 75 / Blue Dci 75 2012>0, Sandero li 1.6 2012>0, Sandero li Tce 90 2012>0, Sandero li Tce 90 Lpg 2015>0;

RENAULT: Logan li Estate 1.2 16V 2013>0, Logan li Estate 1.2 16V Lpg 2013>0, Logan li Estate 1.5 Dci 2009>0, Logan li Estate 1.6 2012>0, Logan/Stepway li 1.0 Hi-Flex 2013>0, Logan/Stepway li 1.2 2012>0, Logan/Stepway li 1.5 Dci 2009>0, Logan/Stepway li 1.6 2012>0, Logan/Stepway li 1.6 Flex 2012>0, Sandero/Stepway I 1.0 Authentique Hi-Flex 2014>0, Sandero/Stepway I 1.6 Flex 2014>0, Sandero/Stepway li 1.6 2012>0, Sandero/Stepway li 1.6 16V 2014>0, Sandero/Stepway li 1.6 Hi-Flex 2017>0, Thalia li 0.9 Tce 2012>0, Thalia li 1.5 Dci 2009>0, Thalia li 1.2 16V 2013>0, Thalia li 1.5 Dci 2009>0

GS2157 // NEW //
FRONT WHEEL SENSOR (BOTH SIDES)

REPLACES / REEMPLAZA:

Renault: 479104991R, 479104225R; **A.B.S.:** 31583;

Meat & Doria: 90644

APPLICATION / APLICACIÓN:

DACIA: Dokker Estate 1.2 Tce 2012>0, Dokker Estate 1.5 Dci 2012>0, Dokker Estate 1.5 Dci / Blue Dci 75 2012>0, Dokker Estate 1.6 2012>0, Dokker Estate 1.6 Lpg 2013>0, Dokker Express Box 1.2 Tce 115 2015>0, Dokker Express Box 1.2 Tce 115 2012>0, Dokker Express Box 1.5 Dci 2012>0, Dokker Express Box 1.5 Dci 75 / Blue Dci 75 2012>0, Dokker Express Box 1.6 2012>0, Dokker Express Box 1.6 Lpg 2013>0, Lodgy 1.2 Tce 2012>0, Lodgy 1.5 Dci 2012>0, Lodgy 1.6 2012>0, Lodgy 1.6 Lpg 2013>0, Lodgy 1.6 Sce 100 2015>0, Logan li 1.2 2012>0, Logan li 1.2 Lpg 2012>0, Logan li 1.5 Dci 2012>0, Logan li 1.5 Dci / Blue Dci 75 2012>0, Logan li 1.6 16V 2013>0, Logan li Tce 90 2012>0, Logan Mcv li 1.2 2012>0, Logan Mcv li 1.2 Lpg 2012>0, Logan Mcv li 1.5 Dci 2012>0, Logan Mcv li 1.5 Dci 2012>0, Logan Mcv li Tce 90 2012>0, Logan Mcv li Tce 90 Lpg 2015>0, Sandero li 1.2 2012>0, Sandero li 1.2 Lpg 2012>0, Sandero li 1.5 Dci 2012>0, Sandero li 1.5 Dci 75 / Blue Dci 75 2012>0, Sandero li Tce 90 2012>0, Sandero li Tce 90 Lpg 2015>0

GS2158 // NEW //
FRONT WHEEL SENSOR (BOTH SIDES)

REPLACES / REEMPLAZA:

Fiat: 51792165, 46816928, 46784471, 0265008002, 0265007401; **Bosch:** 0 265 008 002; **Delphi:** SS20272; **Cargo:** 182334; **Meat & Doria:** 90195, 90195E;

Mobiltron: AB-EU227

APPLICATION / APLICACIÓN:

FIAT: Bravo II 1.4 (198AXA1B) 2006>2016, Bravo II 1.4 16V (198AXS1B) 2006>2016, Bravo II 1.4 LPG (198AXA1B) 2006>2016, Bravo II 1.4 T-Jet (198257) 2006>2016, Bravo II 1.4 T-Jet (198AXF1B) 2006>2016, Bravo II 1.4 T-Jet (198AXG1B) 2006>2016, Bravo II 1.6 D Multijet (198AXH1B) 2006>2016, Bravo II 1.6 D Multijet (198AXL1B) 2006>2016, Bravo II 1.6 D Multijet (198AXM1B) 2006>2016, Bravo II 1.9 D Multijet (198AXB1A) 2006>2016, Bravo II 1.9 D Multijet (198AXC1B) 2006>2016, Bravo II 1.9 D Multijet (198AXD1A) 2006>2016, Bravo II 1.9 D Multijet (198AXE1A) 2006>2016, Bravo II 2.0 D Multijet (198AXN1B) 2006>2016, Bravo II 2.0 D Multijet (198AXP1B) 2006>2016, Bravo Van 1.6 JTD (198AXH1B) 2008>2014, Stilo 1.2 16V (192_XA1B) 2001>2010, Stilo 1.4 16V 2001>2010, Stilo 1.4 16V (192AXH1B, 192BXH1B) 2001>2010, Stilo 1.6 2001>2010, Stilo 1.6 16V 2001>2010, Stilo 1.6 16V (192_XB1A) 2001>2010, Stilo 1.8 2001>2010, Stilo 1.8 16V 2001>2010, Stilo 1.8 16V (192AXC1A, 192BXC1A) 2001>2010, Stilo 1.8 8V 2001>2010, Stilo 1.8 Flex 2001>2010, Stilo 1.9 D Multijet 2001>2010, Stilo 1.9 JTD 2001>2010, Stilo 1.9 JTD (192_XE1A) 2001>2010, Stilo 1.9 JTD (192_XF1A) 2001>2010, Stilo 1.9 JTD (192AXS1B, 192BXS1B) 2001>2010, Stilo 2.4 20V 2001>2010, Stilo 2.4 20V (192_XD1A, 192AXD12) 2001>2010, Stilo Multi Wagon 1.4 16V 2003>2008, Stilo Multi Wagon 1.6 16V 2003>2008, Stilo Multi Wagon 1.8 16V 2003>2008, Stilo Multi Wagon 1.9 D 2003>2008, Stilo Multi Wagon 1.9 D Multijet 2003>2008, Stilo Multi Wagon 1.9 D Multijet (192DXT1B) 2003>2008, Stilo Multi Wagon 1.9 JTD 2003>2008, Stilo Multi Wagon 2.4 20V (19245ZO) 2003>2008, Stilo VAN 1.4 (192DXH1B) 2001>2008, Stilo VAN 1.6 (192DXB1A) 2001>2008, Stilo VAN 1.6 (192DXR1A) 2001>2008, Stilo VAN 1.9 JTD (192DXE1A) 2001>2008, Stilo VAN 1.9 JTD (192DXF1A) 2001>2008, Stilo VAN 1.9 JTD (192DXG1B) 2001>2008, Stilo VAN 1.9 JTD (192DXS1A) 2001>2008, Stilo VAN 1.9 JTD (192DXT1B) 2001>2008;

LANCIA: Delta III 1.4 2008>2014, Delta III 1.4 16V 2008>2014, Delta III 1.4 Bifuel 2008>2014, Delta III 1.6 D Multijet 2008>2014, Delta III 1.8 2008>2014, Delta III 1.9 D Multijet 2008>2014, Delta III 2.0 D Multijet 2008>2014

GS2159 // NEW //

REAR WHEEL SENSOR (BOTH SIDES)



REPLACES / REEMPLAZA:

Fiat: 51792166; **Bosch:** 0 265 008 003; **Meat & Doria:** 90196

APPLICATION / APLICACIÓN:

FIAT: Bravo li 1.4 2007>0, Bravo li 1.4 16V 2010>0, Bravo li 1.4 Lpg 2008>0, Bravo li 1.4 T-Jet 2011>0, Bravo li 1.4 T-Jet 2007>0, Bravo li 1.6 D Multijet 2007>0, Bravo li 1.6 D Multijet 2008>0, Bravo li 1.9 D Multijet 2007>0, Bravo li 1.9 D Multijet 2006>0, Bravo li 2.0 D Multijet 2008>0, Bravo Van 1.6 Jtd 2008>0, Stilo 1.2 16V 2002>0, Stilo 1.4 16V 2004>0, Stilo 1.4 16V 2003>0, Stilo 1.6 16V 2003>0, Stilo 1.6 16V 2001>0, Stilo 1.8 16V 2001>0, Stilo 1.9 D Multijet 2005>0, Stilo 1.9 Jtd 2003>0, Stilo 1.9 Jtd 2001>0, Stilo 1.9 Jtd 2002>0, Stilo 1.9 Jtd 2004>0, Stilo 2.4 20V 2001>0, Stilo Multi Wagon 1.4 16V 2004>0, Stilo Multi Wagon 1.6 16V 2003>0, Stilo Multi Wagon 1.8 16V 2003>0, Stilo Multi Wagon 1.9 D 2004>0, Stilo Multi Wagon 1.9 D Multijet 2005>0, Stilo Multi Wagon 1.9 Jtd 2003>0, Stilo Multi Wagon 2.4 20V 2004>0, Stilo Van 1.4 2004>0, Stilo Van 1.6 2005>0, Stilo Van 1.9 Jtd 2001>0, Stilo Van 1.9 Jtd 2003>0, Stilo Van 1.9 Jtd 2005>0;

LANCIA: Delta lli 1.4 2008>0, Delta lli 1.4 16V 2004>0, Delta lli 1.4 Bifuel 2011>0, Delta lli 1.6 D Multijet 2008>0, Delta lli 1.8 2009>0, Delta lli 1.9 D Multijet 2005>0, Delta lli 2.0 D Multijet 2008>0

GS2160 // NEW //

FRONT WHEEL SENSOR (LEFT SIDE)



REPLACES / REEMPLAZA:

Fiat: 46763852, 60816027, 46539830, 0265007073, 0265007009; **Bosch:** 0 265 007 073; **Meat & Doria:** 90013; **Mobiletron:** AB-EU229

APPLICATION / APLICACIÓN:

ALFA ROMEO: GTV 1.8 16V (916C3) 1995>2005, GTV 2.0 JTS (916CXA00) 1995>2005, GTV 2.0 T.Spark 16V (916.C2_) 1995>2005, GTV 2.0 T.Spark 16V (916C2C00) 1995>2005, GTV 2.0 T.Spark 16V (916C2C) 1995>2005, GTV 3.0 V6 24V (916.C1) 1995>2005, GTV 3.0 V6 24V (916.C1B_) 1995>2005, GTV 3.2 V6 24V (916CXB00) 1995>2005, Spider 1.8 16V (916S3) 1994>2005, Spider 2.0 JTS (916SXA00) 1994>2005, Spider 2.0 T.Spark 16V (916S2B) 1994>2005, Spider 2.0 T.Spark 16V (916S2C00) 1994>2005, Spider 2.0 V6 Turbo (916S2A) 1994>2005, Spider 3.0 V6 (916S1) 1994>2005, Spider 3.0 V6 (916S1B00) 1994>2005, Spider 3.0 V6 24V (916S1) 1994>2005, Spider 3.2 V6 24V (916SXB00) 1994>2005, GTV 2.0 V6 Turbo (916.C2A) 1995>2005;

LANCIA: Lybra 1.6 1999>2005, Lybra 1.6 16V (839AXA1A) 1999>2005, Lybra 1.8 16V (839AXB1A, 839AXG1A) 1999>2005, Lybra 1.9 JTD 1999>2005, Lybra 1.9 JTD (839AXD1A) 1999>2005, Lybra 1.9 JTD (839AXI1A) 1999>2005, Lybra 2.0 20V (839AXC11, 839AXC1A) 1999>2005, Lybra 2.0 20V (839AXH1A) 1999>2005, Lybra 2.4 20V 1999>2005, Lybra 2.4 JTD 1999>2005, Lybra 2.4 JTD (839AXE1A) 1999>2005, Lybra 2.4 JTD (839AXL1A) 1999>2005, Lybra SW 1.6 1999>2005, Lybra SW 1.6 16V (839BXA1A) 1999>2005, Lybra SW 1.8 16V (839BXB1A, 839BXG1A) 1999>2005, Lybra SW 1.9 JTD 1999>2005, Lybra SW 1.9 JTD (839BXD1A) 1999>2005, Lybra SW 1.9 JTD (839BXI1A) 1999>2005, Lybra SW 2.0 20V (839BXC11, 839BXC1A) 1999>2005, Lybra SW 2.0 20V (839BXH1A) 1999>2005, Lybra SW 2.4 JTD 1999>2005, Lybra SW 2.4 JTD (839BXE1A) 1999>2005, Lybra SW 2.4 JTD (839BXL1A) 1999>2005;

FIAT: Marea 1.2 16V 1996>2007, Marea 1.6 1996>2007, Marea 1.6 100 16V 1996>2007, Marea 1.6 100 16V Bipower 1996>2007, Marea 1.6 SX 1996>2007, Marea 1.8 115 16V 1996>2007, Marea 1.9 JTD 105 (185AXN1A) 1996>2007, Marea 1.9 JTD 110 (185AXT1A) 1996>2007, Marea 1.9 TD 75 1996>2007, Marea 2.0 150 20V 1996>2007, Marea 2.0 155 20V 1996>2007, Marea 2.4 JTD 130 1996>2007, Marea Weekend 1.2 16V 1996>2007, Marea Weekend 1.6 1996>2007, Marea Weekend 1.6 100 16V 1996>2007, Marea Weekend 1.8 115 16V 1996>2007, Marea Weekend 1.9 JTD 105 (185BXN1A) 1996>2007, Marea Weekend 1.9 JTD 110 (185BXT1A) 1996>2007, Marea Weekend 1.9 TD 100 (185BX_) 1996>2007, Marea Weekend 1.9 TD 75 1996>2007, Marea Weekend 2.0 150 20V 1996>2007, Marea Weekend 2.0 155 20V 1996>2007, Marea Weekend 2.4 JTD 130 1996>2007, Marea 1.4 80 12V 1996>2007, Marea 1.6 16V 1996>2007, Marea 1.9 JTD 1996>2007, Marea 1.9 TD 100 (185AX_) 1996>2007, Marea 2.4 TD 125 1996>2007, Marea Weekend 1.4 80 12V 1996>2007, Marea Weekend 2.4 TD 125 1996>2007

GS2161 // NEW //

FRONT WHEEL SENSOR (RIGHT SIDE)



REPLACES / REEMPLAZA:

Fiat: 46763853, 60816028, 46539831, 46532099, 0265007074, 0265007013, 0265007035; **Bosch:** 0 265 007 074; **Delphi:** SS20576; **Meat & Doria:** 90014;

Mobiletron: AB-EU230

APPLICATION / APLICACIÓN:

ALFA ROMEO: GTV 1.8 16V (916C3) 1995>2005, GTV 2.0 JTS (916CXA00) 1995>2005, GTV 2.0 T.Spark 16V (916.C2_) 1995>2005, GTV 2.0 T.Spark 16V (916C2C00) 1995>2005, GTV 2.0 T.Spark 16V (916C2C) 1995>2005, GTV 3.0 V6 24V (916.C1) 1995>2005, GTV 3.0 V6 24V (916.C1B_) 1995>2005, GTV 3.2 V6 24V (916CXB00) 1995>2005, Spider 1.8 16V (916S3) 1994>2005, Spider 2.0 JTS (916SXA00) 1994>2005, Spider 2.0 T.Spark 16V (916S2B) 1994>2005, Spider 2.0 T.Spark 16V (916S2C00) 1994>2005, Spider 2.0 V6 Turbo (916S2A) 1994>2005, Spider 3.0 V6 (916S1) 1994>2005, Spider 3.0 V6 (916S1B00) 1994>2005, Spider 3.0 V6 24V (916S1) 1994>2005, Spider 3.2 V6 24V (916SXB00) 1994>2005, GTV 2.0 V6 Turbo (916.C2A) 1995>2005;

LANCIA: Lybra 1.6 1999>2005, Lybra 1.6 16V (839AXA1A) 1999>2005, Lybra 1.8 16V (839AXB1A, 839AXG1A) 1999>2005, Lybra 1.9 JTD 1999>2005, Lybra 1.9 JTD (839AXD1A) 1999>2005, Lybra 1.9 JTD (839AXI1A) 1999>2005, Lybra 2.0 20V (839AXC11, 839AXC1A) 1999>2005, Lybra 2.0 20V (839AXH1A) 1999>2005, Lybra 2.4 20V 1999>2005, Lybra 2.4 JTD 1999>2005, Lybra 2.4 JTD (839AXE1A) 1999>2005, Lybra 2.4 JTD (839AXL1A) 1999>2005, Lybra SW 1.6 1999>2005, Lybra SW 1.6 16V (839BXA1A) 1999>2005, Lybra SW 1.8 16V (839BXB1A, 839BXG1A) 1999>2005, Lybra SW 1.9 JTD 1999>2005, Lybra SW 1.9 JTD (839BXD1A) 1999>2005, Lybra SW 1.9 JTD (839BXI1A) 1999>2005, Lybra SW 2.0 20V (839BXC11, 839BXC1A) 1999>2005, Lybra SW 2.0 20V (839BXH1A) 1999>2005, Lybra SW 2.4 JTD 1999>2005, Lybra SW 2.4 JTD (839BXE1A) 1999>2005, Lybra SW 2.4 JTD (839BXL1A) 1999>2005;

FIAT: Marea 1.2 16V 1996>2007, Marea 1.6 1996>2007, Marea 1.6 100 16V 1996>2007, Marea 1.6 100 16V Bipower 1996>2007, Marea 1.6 SX 1996>2007, Marea 1.8 115 16V 1996>2007, Marea 1.9 JTD 105 (185AXN1A) 1996>2007, Marea 1.9 JTD 110 (185AXT1A) 1996>2007, Marea 1.9 TD 75 1996>2007, Marea 2.0 150 20V 1996>2007, Marea 2.0 155 20V 1996>2007, Marea 2.4 JTD 130 1996>2007, Marea Weekend 1.2 16V 1996>2007, Marea Weekend 1.6 1996>2007, Marea Weekend 1.6 100 16V 1996>2007, Marea Weekend 1.8 115 16V 1996>2007, Marea Weekend 1.9 JTD 105 (185BXN1A) 1996>2007, Marea Weekend 1.9 JTD 110 (185BXT1A) 1996>2007, Marea Weekend 1.9 TD 100 (185BX_) 1996>2007, Marea Weekend 1.9 TD 75 1996>2007, Marea Weekend 2.0 150 20V 1996>2007, Marea Weekend 2.0 155 20V 1996>2007, Marea Weekend 2.4 JTD 130 1996>2007, Marea 1.4 80 12V 1996>2007, Marea 1.6 16V 1996>2007, Marea 1.9 JTD 1996>2007, Marea 1.9 TD 100 (185AX_) 1996>2007, Marea 2.0 1996>2007, Marea 2.0 155 20V 1996>2007, Marea 2.4 TD 125 1996>2007, Marea Weekend 1.4 80 12V 1996>2007, Marea Weekend 2.0 1996>2007, Marea Weekend 2.4 TD 125 1996>2007

GS2162 // NEW //

REAR WHEEL SENSOR (RIGHT SIDE)



REPLACES / REEMPLAZA:

Fiat: 51796983, 46441569, 46539833, 0265007134; **Bosch:** 0 265 007 033; **Meat & Doria:** 90204; **Mobiletron:** AB-EU226

APPLICATION / APLICACIÓN:

FIAT: BRAVA 1.6 16V 2000>2003, BRAVA 1.8 16V 2000>2003, Marea 1.2 16V 1996>2007, Marea 1.4 80 12V 1996>2007, Marea 1.6 1996>2007, Marea 1.6 100 16V 1996>2007, Marea 1.6 100 16V Bipower 1996>2007, Marea 1.6 16V 1996>2007, Marea 1.6 SX 1996>2007, Marea 1.8 1996>2007, Marea 1.8 115 16V 1996>2007, Marea 1.9 JTD 105 (185AXN1A) 1996>2007, Marea 1.9 JTD 110 (185AXT1A) 1996>2007, Marea 1.9 TD 75 1996>2007, Marea 2.0 1996>2007, Marea 2.0 150 20V 1996>2007, Marea 2.0 155 20V 1996>2007, Marea 2.4 1996>2007, Marea 2.4 JTD 130 1996>2007, Marea Weekend 1.2 16V 1996>2007, Marea Weekend 1.4 80 12V 1996>2007, Marea Weekend 1.6 1996>2007, Marea Weekend 1.6 100 16V 1996>2007, Marea Weekend 1.8 1996>2007, Marea Weekend 1.8 115 16V 1996>2007, Marea Weekend 1.9 JTD 105 (185BXN1A) 1996>2007, Marea Weekend 1.9 JTD 110 (185BXT1A) 1996>2007, Marea Weekend 1.9 TD 100 (185BX_) 1996>2007, Marea Weekend 1.9 TD 75 1996>2007, Marea Weekend 2.0 1996>2007, Marea Weekend 2.0 150 20V 1996>2007, Marea Weekend 2.0 155 20V 1996>2007, Marea Weekend 2.4 1996>2007, Marea Weekend 2.4 JTD 130 1996>2007, Marea 1.9 JTD 1996>2007, Marea 1.9 TD 100 (185AX_) 1996>2007, Marea 2.4 TD 125 1996>2007, Marea Weekend 2.4 TD 125 1996>2007

GS2163 // NEW //
REAR WHEEL SENSOR (LEFT SIDE)
REPLACES / REEMPLAZA:
Fiat: 46539832, 46441568, 0265007032; **Bosch:** 0 265 007 032; **Meat & Doria:** 90203; **Mobiletron:** AB-EU234

APPLICATION / APLICACIÓN:
FIAT: Brava 1.6 16V 2000>2003, Brava 1.8 16V 2000>2003, Marea 1.2 16V 1996>2007, Marea 1.4 80 12V 1996>2007, Marea 1.6 1996>2007, Marea 1.6 100 16V 1996>2007, Marea 1.6 100 16V Bipower 1996>2007, Marea 1.6 16V 1996>2007, Marea 1.6 SX 1996>2007, Marea 1.8 1996>2007, Marea 1.8 115 16V 1996>2007, Marea 1.9 JTD 105 (185AXN1A) 1996>2007, Marea 1.9 JTD 110 (185AXT1A) 1996>2007, Marea 1.9 TD 75 1996>2007, Marea 2.0 1996>2007, Marea 2.0 150 20V 1996>2007, Marea 2.0 155 20V 1996>2007, Marea 2.4 1996>2007, Marea 2.4 JTD 130 1996>2007, Marea Weekend 1.2 16V 1996>2007, Marea Weekend 1.4 80 12V 1996>2007, Marea Weekend 1.6 1996>2007, Marea Weekend 1.6 100 16V 1996>2007, Marea Weekend 1.8 1996>2007, Marea Weekend 1.8 115 16V 1996>2007, Marea Weekend 1.9 JTD 105 (185BXN1A) 1996>2007, Marea Weekend 1.9 JTD 110 (185BXT1A) 1996>2007, Marea Weekend 1.9 TD 100 (185BX_) 1996>2007, Marea Weekend 1.9 TD 75 1996>2007, Marea Weekend 2.0 1996>2007, Marea Weekend 2.0 150 20V 1996>2007, Marea Weekend 2.0 155 20V 1996>2007, Marea Weekend 2.4 1996>2007, Marea Weekend 2.4 JTD 130 1996>2007, Marea 1.9 JTD 1996>2007, Marea 1.9 TD 100 (185AX_) 1996>2007, Marea 2.4 TD 125 1996>2007, Marea Weekend 2.4 TD 125 1996>2007

GS2164
FRONT WHEEL SENSOR
REPLACES / REEMPLAZA:
Bosch: 0 986 594 580

Fiat: 51763164, 51918228

APPLICATION / APLICACIÓN:
Fiat: Fiorino, Linea, Fiorino Qubo

PS: set of GS2490 and GS2165

GS2165
REAR WHEEL SENSOR (LEFT SIDE)
REPLACES / REEMPLAZA:
Fiat: 51763165

APPLICATION / APLICACIÓN:
Fiat: Fiorino 1.3/1.4, Linea 1.3/1.4/1.6, Fiorino Qubo 1.3/1.4

PS: set of GS2490

GS2166 // NEW //
REAR WHEEL SENSOR (BOTH SIDES)
REPLACES / REEMPLAZA:
Fiat: 51764254, 51782787, K68199238AB, 51801310; **Peugeot:** 4545H2, 0265007833; **Bosch:** 0 265 007 833; **Delphi:** SS20388; **Meat & Doria:** 90272, 90272E;

Mobiletron: AB-EU146

APPLICATION / APLICACIÓN:
FIAT: Ducato Box 100 Multijet 2,2 D 2006>2014, Ducato Box 110 Multijet 2,3 D 2006>2014, Ducato Box 115 Multijet 2,0 D 2006>2014, Ducato Box 120 Multijet 2,3 D 2006>2014, Ducato Box 120 Multijet 2,3 D 4x4 2006>2014, Ducato Box 130 Multijet 2,3 D 2006>2014, Ducato Box 140 Multijet 2,3 D 2006>2014, Ducato Box 140 Multijet 3,0 D 2006>2014, Ducato Box 140 Natural Power 2006>2014, Ducato Box 150 Multijet 2,3 D 2006>2014, Ducato Box 150 Multijet 2,3 D 4x4 2006>2014, Ducato Box 150 Multijet 3,0 D 2006>2014, Ducato Box 160 Multijet 2,3 D 2006>2014, Ducato Box 160 Multijet 3,0 D 2006>2014, Ducato Box 160 Multijet 3,0 D 4x4 2006>2014, Ducato Box 180 Multijet 2,3 D 2006>2014, Ducato Box 180 Multijet 3,0 D 2006>2014, Ducato Bus 100 Multijet 2,2 D 2006>2014, Ducato Bus 110 Multijet 2,3 D 2006>2014, Ducato Bus 115 Multijet 2,0 D 2006>2014, Ducato Bus 120 Multijet 2,3 D 2006>2014, Ducato Bus 140 Multijet 2,3 D 2006>2014, Ducato Bus 140 Multijet 3,0 D 2006>2014, Ducato Bus 140 Natural Power 2006>2014, Ducato Bus 150 Multijet 2,3 D 2006>2014, Ducato Bus 150 Multijet 2,3 D 4x4 2006>2014, Ducato Bus 150 Multijet 3,0 D 2006>2014, Ducato Bus 160 Multijet 2,3 D 2006>2014, Ducato Bus 160 Multijet 3,0 D 2006>2014, Ducato Bus 160 Multijet 3,0 D 4x4 2006>2014, Ducato Bus 180 Multijet 2,3 D 2006>2014, Ducato Bus 180 Multijet 3,0 D 2006>2014, Ducato Platparam/Chassis 100 Multijet 2,2 D 2006>2014, Ducato Platparam/Chassis 110 Multijet 2,3 D 2006>2014, Ducato Platparam/Chassis 115 Multijet 2,0 D 2006>2014, Ducato Platparam/Chassis 120 Multijet 2,3 D 2006>2014, Ducato Platparam/Chassis 120 Multijet 2,3 D 4x4 2006>2014, Ducato Platparam/Chassis 130 Multijet 2,3 D 2006>2014, Ducato Platparam/Chassis 140 Multijet 2,3 D 2006>2014, Ducato Platparam/Chassis 140 Multijet 3,0 D 2006>2014, Ducato Platparam/Chassis 140 Natural Power 2006>2014, Ducato Platparam/Chassis 150 Multijet 2,3 D 2006>2014, Ducato Platparam/Chassis 150 Multijet 3,0 D 2006>2014, Ducato Platparam/Chassis 160 Multijet 2,3 D 2006>2014, Ducato Platparam/Chassis 160 Multijet 3,0 D 2006>2014, Ducato Platparam/Chassis 180 Multijet 2,3 D 2006>2014, Ducato Platparam/Chassis 180 Multijet 3,0 D 2006>2014, Ducato Bus 130 Multijet 2,3 D 2006>2014;

PEUGEOT: Boxer Box 2.0 BlueHDi 110 2006>2019, Boxer Box 2.0 BlueHDi 130 2006>2019, Boxer Box 2.0 BlueHDi 160 2006>2019, Boxer Box 2.2 BlueHDi 120 2006>2019, Boxer Box 2.2 BlueHDi 140 2006>2019, Boxer Box 2.2 BlueHDi 165 2006>2019, Boxer Box 2.2 HDi 100 2006>2019, Boxer Box 2.2 HDi 110 2006>2019, Boxer Box 2.2 HDi 120 2006>2019, Boxer Box 2.2 HDi 130 2006>2019, Boxer Box 2.2 HDi 150 2006>2019, Boxer Box 3.0 D 2006>2019, Boxer Box 3.0 HDi 2006>2019, Boxer Box 3.0 HDi 145 2006>2019, Boxer Box 3.0 HDi 160 2006>2019, Boxer Box 3.0 HDi 175 2006>2019, Boxer Bus 2.0 BlueHDi 110 2006>2019, Boxer Bus 2.0 BlueHDi 130 2006>2019, Boxer Bus 2.0 BlueHDi 160 2006>2019, Boxer Bus 2.2 BlueHDi 120 2006>2019, Boxer Bus 2.2 BlueHDi 140 2006>2019, Boxer Bus 2.2 HDi 100 2006>2019, Boxer Bus 2.2 HDi 110 2006>2019, Boxer Bus 2.2 HDi 120 2006>2019, Boxer Bus 2.2 HDi 130 2006>2019, Boxer Bus 2.2 HDi 150 2006>2019, Boxer Bus 3.0 HDi 145 2006>2019, Boxer Bus 3.0 HDi 160 2006>2019, Boxer Bus 3.0 HDi 175 2006>2019, Boxer Platparam/Chassis 2.0 BlueHDi 110 2006>2019, Boxer Platparam/Chassis 2.0 BlueHDi 130 2006>2019, Boxer Platparam/Chassis 2.0 BlueHDi 160 2006>2019, Boxer Platparam/Chassis 2.2 HDi 100 2006>2019, Boxer Platparam/Chassis 2.2 HDi 110 2006>2019, Boxer Platparam/Chassis 2.2 HDi 120 2006>2019, Boxer Platparam/Chassis 2.2 HDi 130 2006>2019, Boxer Platparam/Chassis 2.2 HDi 150 2006>2019, Boxer Platparam/Chassis 3.0 HDi 2006>2019, Boxer Platparam/Chassis 3.0 HDi 145 2006>2019, Boxer Platparam/Chassis 3.0 HDi 160 2006>2019, Boxer Platparam/Chassis 3.0 HDi 175 2006>2019;

CITROËN: Jumper Box 2.0 BlueHDi 110 2006>2019, Jumper Box 2.0 BlueHDi 130 2006>2019, Jumper Box 2.0 BlueHDi 160 2006>2019, Jumper Box 2.0 BlueHDi 160 4x4 2006>2019, Jumper Box 2.2 HDi 100 2006>2019, Jumper Box 2.2 HDi 110 2006>2019, Jumper Box 2.2 HDi 120 2006>2019, Jumper Box 2.2 HDi 130 2006>2019, Jumper Box 2.2 HDi 150 2006>2019, Jumper Box 2.3 HDi 2006>2019, Jumper Box 3.0 HDi 145 2006>2019, Jumper Box 3.0 HDi 155 2006>2019, Jumper Box 3.0 HDi 160 2006>2019, Jumper Box 3.0 HDi 180 2006>2019, Jumper Bus 2.0 BlueHDi 110 2006>2019, Jumper Bus 2.0 BlueHDi 130 2006>2019, Jumper Bus 2.0 BlueHDi 160 2006>2019, Jumper Bus 2.2 HDi 100 2006>2019, Jumper Bus 2.2 HDi 110 2006>2019, Jumper Bus 2.2 HDi 120 2006>2019, Jumper Bus 2.2 HDi 130 2006>2019, Jumper Bus 2.2 HDi 150 2006>2019, Jumper Bus 3.0 HDi 155 2006>2019, Jumper Bus 3.0 HDi 160 2006>2019, Jumper Bus 3.0 HDi 180 2006>2019, Jumper Platparam/Chassis 2.0 BlueHDi 110 2006>2019, Jumper Platparam/Chassis 2.0 BlueHDi 130 2006>2019, Jumper Platparam/Chassis 2.0 BlueHDi 130 4x4 2006>2019, Jumper Platparam/Chassis 2.0 BlueHDi 160 2006>2019, Jumper Platparam/Chassis 2.0 BlueHDi 160 4x4 2006>2019, Jumper Platparam/Chassis 2.2 HDi 100 2006>2019, Jumper Platparam/Chassis 2.2 HDi 110 2006>2019, Jumper Platparam/Chassis 2.2 HDi 120 2006>2019, Jumper Platparam/Chassis 2.2 HDi 130 2006>2019, Jumper Platparam/Chassis 2.2 HDi 150 2006>2019, Jumper Platparam/Chassis 3.0 HDi 145 2006>2019, Jumper Platparam/Chassis 3.0 HDi 160 2006>2019, Jumper Platparam/Chassis 3.0 HDi 180 2006>2019

GS2167 // NEW //
REAR WHEEL SENSOR (LEFT SIDE)

REPLACES / REEMPLAZA:

Fiat: 46540025, 51799534, 0265007054, 0265007133;

Bosch: 0 265 007 054

APPLICATION / APLICACIÓN:

FIAT: Siena 1.4 Flex 2004>2007, Strada Pickup 1.2 1998>2012, Strada Pickup 1.3 D Multijet 1998>2012, Strada Pickup 1.4 1998>2012, Strada Pickup 1.4 Flex 1998>2012, Strada Pickup 1.5 1998>2012, Strada Pickup 1.5 Lcool 1998>2012, Strada Pickup 1.6 16V 1998>2012, Strada Pickup 1.6 8V 1998>2012, Strada Pickup 1.7 TD 1998>2012, Strada Pickup 1.8 1998>2012, Strada Pickup 1.8 Flex 1998>2012, Strada Pickup 1.9 D 1998>2012, Strada Pickup 1.9 JTD 1998>2012, Strada Pickup 1.3 D Multijet (278AYR1A) 2009>1900, Strada Pickup 1.4 Flex (27802M3) 2009>1900, Strada Pickup 1.6 Flex 2009>1900, Strada Pickup 1.8 Flex (27802P3) 2009>1900

GS2168 // NEW //
REAR WHEEL SENSOR (RIGHT SIDE)

REPLACES / REEMPLAZA:

Fiat: 46540024, 51796984, 0265007055, 0265007132;

Bosch: 0 265 007 055

APPLICATION / APLICACIÓN:

FIAT: Siena 1.4 Flex 2004>2007, Strada Pickup 1.2 1998>2012, Strada Pickup 1.3 D Multijet 1998>2012, Strada Pickup 1.4 1998>2012, Strada Pickup 1.4 Flex 1998>2012, Strada Pickup 1.5 1998>2012, Strada Pickup 1.5 Lcool 1998>2012, Strada Pickup 1.6 16V 1998>2012, Strada Pickup 1.6 8V 1998>2012, Strada Pickup 1.7 TD 1998>2012, Strada Pickup 1.8 1998>2012, Strada Pickup 1.8 Flex 1998>2012, Strada Pickup 1.9 D 1998>2012, Strada Pickup 1.9 JTD 1998>2012, Strada Pickup 1.3 D Multijet (278AYR1A) 2009>1900, Strada Pickup 1.4 Flex (27802M3) 2009>1900, Strada Pickup 1.6 Flex 2009>1900, Strada Pickup 1.8 Flex (27802P3) 2009>1900

GS2169 // NEW //
REAR WHEEL SENSOR (BOTH SIDES)

REPLACES / REEMPLAZA:

Fiat: 51966686, 51966684

APPLICATION / APLICACIÓN:

FIAT: Toro 4x2 2017>

GS2170 // NEW //
REAR WHEEL SENSOR (BOTH SIDES)

REPLACES / REEMPLAZA:

Fiat: 52055240, 51966687

APPLICATION / APLICACIÓN:

FIAT: Toro 4x4 2017>

GS2171 // NEW //
FRONT AND REAR WHEEL SENSOR (BOTH SIDES)

REPLACES / REEMPLAZA:

Ford: 1S7T2B372AD, 1S7T2B372A, 1386268, 1146400, 1115018; **Bosch:** 0 265 007 879, 0 986 594 610; **Delphi:** SS20144; **Hitachi:** 131661; **Meat & Doria:** 90094, 90094A1, 90094E; **Mobiletron:** AB-EU004

APPLICATION / APLICACIÓN:

JAGUAR: X-TYPE 2.0 D 2001>2009, X-TYPE 2.1 V6 2001>2009, X-TYPE 2.2 D 2001>2009, X-TYPE 2.5 V6 All-wheel Drive 2001>2009, X-TYPE Estate 2.0 D 2003>2009, X-TYPE Estate 2.1 V6 2003>2009, X-TYPE Estate 2.5 2003>2009, X-TYPE Estate 3.0 2003>2009, **FORD:** Mondeo III 1.8 16V 2000>2007, Mondeo III 1.8 SCi 2000>2007, Mondeo III 2.0 16V 2000>2007, Mondeo III 2.0 16V DI / TDDi / TDCi 2000>2007, Mondeo III 2.0 16V TDDi / TDCi 2000>2007, Mondeo III 2.0 DI 2000>2007, Mondeo III 2.0 TDCi 2000>2007, Mondeo III 2.2 TDCi 2000>2007, Mondeo III 2.5 V6 24V 2000>2007, Mondeo III 3.0 V6 24V 2000>2007, Mondeo III ST220 2000>2007, Mondeo III Saloon 1.8 16V 2000>2007, Mondeo III Saloon 1.8 SCi 2000>2007, Mondeo III Saloon 2.0 16V 2000>2007, Mondeo III Saloon 2.0 16V DI / TDDi / TDCi 2000>2007, Mondeo III Saloon 2.0 16V TDDi / TDCi 2000>2007, Mondeo III Saloon 2.0 DI 2000>2007, Mondeo III Saloon 2.0 TDCi 2000>2007, Mondeo III Saloon 2.2 TDCi 2000>2007, Mondeo III Saloon 2.5 V6 2000>2007, Mondeo III Saloon 2.5 V6 24V 2000>2007, Mondeo III Saloon 3.0 V6 24V 2000>2007, Mondeo III Saloon ST220 2000>2007, Mondeo III Turnier 1.8 16V 2000>2007, Mondeo III Turnier 1.8 SCi 2000>2007, Mondeo III Turnier 2.0 16V 2000>2007, Mondeo III Turnier 2.0 16V DI / TDDi / TDCi 2000>2007, Mondeo III Turnier 2.0 16V TDDi / TDCi 2000>2007, Mondeo III Turnier 2.0 TDCi 2000>2007, Mondeo III Turnier 2.2 TDCi 2000>2007, Mondeo III Turnier 2.5 V6 24V 2000>2007, Mondeo III Turnier 3.0 V6 24V 2000>2007, Mondeo III Turnier ST220 2000>2007

GS2172 // NEW //
REAR WHEEL SENSOR (BOTH SIDES)

REPLACES / REEMPLAZA:

Fiat: 46545467, 0265007051; **Bosch:** 0 265 007 051

APPLICATION / APLICACIÓN:

FIAT: Palio 1.0 1996>0, Palio 1.0 2003>0, Palio 1.0 16V 2000>0, Palio 1.0 Flex 2000>0, Palio 1.0 Rst Biopower 2003>0, Palio 1.2 1997>0, Palio 1.2 2001>0, Palio 1.2 Elx Flex 2003>0, Palio 1.3 2000>0, Palio 1.3 Jtd Multijet 2003>0, Palio 1.4 2005>0, Palio 1.4 2002>0, Palio 1.4 Flex 2004>0, Palio 1.5 2004>0, Palio 1.6 1996>0, Palio 1.6 16V 1996>0, Palio 1.6 Flex 2010>0, Palio 1.8 2001>0, Palio 1.8 2003>0, Palio 1.8 Ex 2003>0, Palio 1.8 Flex 2006>0, Palio 1.8 Rst Flex 2004>0, Palio 1.9 D 2003>0, Palio 1.6 2011>0, Siena 1.0 1996>0, Siena 1.0 16V 2000>0, Siena 1.0 Flex 2000>0, Siena 1.0 Rst Fire 2002>0, Siena 1.0 Rst Fire Flex 2005>0, Siena 1.2 1997>0, Siena 1.2 2001>0, Siena 1.2 Flex 2004>0, Siena 1.4 8V 2005>0, Siena 1.4 8V 2006>0, Siena 1.4 Elx Tetrafuel 2006>0, Siena 1.4 Flex 2004>0, Siena 1.5 Rst ALcool 2002>0, Siena 1.6 16V 1996>0, Siena 1.6 Flex 2010>0, Siena 1.7 Td 2006>0, Siena 1.8 2001>0, Siena 1.8 Bipower 2004>0, Siena 1.8 Flex 2006>0, Siena / Grand Siena 1.0 Flex 2000>0, Siena / Grand Siena 1.4 Flex 2004>0, Siena / Grand Siena 1.4 Tetrafuel 2012>0, Strada Pickup 1.6 2009>0, Strada Pickup 1.8 Flex 2010>0

GS2173
FRONT WHEEL SENSOR

REPLACES / REEMPLAZA:

Fiat: 51797173

Ford: 1563623, 9S512B572AA

APPLICATION / APLICACIÓN:

Fiat: Cinquecento (500) 1.4

Ford: Ka 1.2/1.3

GS2174 // NEW //
REAR WHEEL SENSOR (BOTH SIDES)

REPLACES / REEMPLAZA:

Fiat: K68073206AD

APPLICATION / APLICACIÓN:

FIAT: 500 2010>



GS2176 // NEW //

FRONT WHEEL SENSOR (BOTH SIDES)

REPLACES / REEMPLAZA:

Ford: 3M5T2B372AB; **Volvo:** 30748149, 9475557, 307481490, 94755570, 31423572; **Bosch:** 0 986 594 555; **Hitachi:** 131655; **Meat & Doria:** 90104; **Mobiletron:** AB-EU013

APPLICATION / APLICACIÓN:

...**VOLVO:** V60 I D3 2010>2015, V60 I D4 2010>2015, V60 I D4 AWD 2010>2015, V60 I D5 2010>2015, V60 I D5 AWD 2010>2015, V60 I D6 Hybrid AWD 2010>2015, V60 I T3 2010>2015, V60 I T4 2010>2015, V60 I T4F 2010>2015, V60 I T5 2010>2015, V60 I T5 AWD 2010>2015, V60 I T6 2010>2015, V60 I T6 AWD 2010>2015, V70 III 1.6 D 2007>2015, V70 III 1.6 DRIVE / D2 2007>2015, V70 III 1.6 T4F 2007>2015, V70 III 2.0 2007>2015, V70 III 2.0 D 2007>2015, V70 III 2.0 FlexiFuel 2007>2015, V70 III 2.0 T 2007>2015, V70 III 2.4 D 2007>2015, V70 III 2.5 T 2007>2015, V70 III 2.5 T FlexiFuel 2007>2015, V70 III 3.2 2007>2015, V70 III 3.2 AWD 2007>2015, V70 III D2 2007>2015, V70 III D3 2007>2015, V70 III D3 / D4 2007>2015, V70 III D4 2007>2015, V70 III D4 AWD 2007>2015, V70 III D5 2007>2015, V70 III D5 AWD 2007>2015, V70 III T4 2007>2015, V70 III T5 2007>2015, V70 III T6 AWD 2007>2015, XC60 2.0 T 2008>2017, XC60 2.4 D 2008>2017, XC60 2.4 D / D3 / D4 AWD 2008>2017, XC60 3.2 AWD 2008>2017, XC60 D3 2008>2017, XC60 D3 / D4 2008>2017, XC60 D4 2008>2017, XC60 D4 AWD 2008>2017, XC60 D5 AWD 2008>2017, XC60 T5 2008>2017, XC60 T5 AWD 2008>2017, XC60 T6 2008>2017, XC60 T6 AWD 2008>2017, XC70 II 2.4 D 2007>2015, XC70 II 2.4 D / D4 AWD 2007>2015, XC70 II 3.2 AWD 2007>2015, XC70 II D3 2007>2015, XC70 II D4 2007>2015, XC70 II D4 AWD 2007>2015, XC70 II D5 AWD 2007>2015, XC70 II T5 2007>2015, XC70 II T6 AWD 2007>2015;

FORD: C-Max 1.6 2007>2010, C-Max 1.6 TDCi 2007>2010, C-Max 1.8 2007>2010, C-Max 1.8 Flexifuel 2007>2010, C-Max 1.8 TDCi 2007>2010, C-Max 2.0 2007>2010, C-Max 2.0 CNG 2007>2010, C-Max 2.0 LPG 2007>2010, C-Max 2.0 TDCi 2007>2010, C-Max II 2.0 Energi 2010>1900, C-Max II 2.0 TDCi 2010>1900, Focus C-Max 1.6 2003>2007, Focus C-Max 1.6 TDCi 2003>2007, Focus C-Max 1.6 Ti 2003>2007, Focus C-Max 1.8 2003>2007, Focus C-Max 1.8 TDCi 2003>2007, Focus C-Max 2.0 2003>2007, Focus C-Max 2.0 TDCi 2003>2007, Focus II 1.4 2004>2013, Focus II 1.6 2004>2013, Focus II 1.6 Flex 2004>2013, Focus II 1.6 LPG 2004>2013, Focus II 1.6 TDCi 2004>2013, Focus II 1.6 Ti 2004>2013, Focus II 1.8 2004>2013, Focus II 1.8 Flexifuel 2004>2013, Focus II 1.8 TDCi 2004>2013, Focus II 2.0 2004>2013, Focus II 2.0 CNG 2004>2013, Focus II 2.0 Flex 2004>2013, Focus II 2.0 LPG 2004>2013, Focus II 2.0 TDCi 2004>2013, Focus II 2.5 ST 2004>2013, Focus II Box Body/Estate 1.4 2004>2011, Focus II Box Body/Estate 1.6 2004>2011, Focus II Box Body/Estate 1.6 TDCi 2004>2011, Focus II Box Body/Estate 1.6 Ti-VCT 2004>2011, Focus II Box Body/Estate 1.8 Flexifuel 2004>2011, Focus II Box Body/Estate 2.0 TDCi 2004>2011, Focus II Convertible 1.6 2006>2010, Focus II Convertible 2.0 2006>2010, Focus II Convertible 2.0 TDCi 2006>2010, Focus II Saloon 1.4 2005>2013, Focus II Saloon 1.6 2005>2013, Focus II Saloon 1.6 Flex 2005>2013, Focus II Saloon 1.6 TDCi 2005>2013, Focus II Saloon 1.6 Ti 2005>2013, Focus II Saloon 1.8 2005>2013, Focus II Saloon 1.8 Flexifuel 2005>2013, Focus II Saloon 1.8 TDCi 2005>2013, Focus II Saloon 2.0 2005>2013, Focus II Saloon 2.0 Flex 2005>2013, Focus II Saloon 2.0 TDCi 2005>2013, Focus II Turnier 1.4 2004>2012, Focus II Turnier 1.6 2004>2012, Focus II Turnier 1.6 LPG 2004>2012, Focus II Turnier 1.6 TDCi 2004>2012, Focus II Turnier 1.6 Ti 2004>2012, Focus II Turnier 1.8 2004>2012, Focus II Turnier 1.8 Flexifuel 2004>2012, Focus II Turnier 1.8 TDCi 2004>2012, Focus II Turnier 2.0 2004>2012, Focus II Turnier 2.0 LPG 2004>2012, Focus II Turnier 2.0 TDCi 2004>2012, Focus III 1.6 Flex 2013>2019, Focus III 2.0 2013>2019, Focus III 2.0 Direct Flex 2013>2019, Focus III Saloon 2.0 Direct Flex 2013>2019, Galaxy 1.6 EcoBoost 2006>2015, Galaxy 1.6 TDCi 2006>2015, Galaxy 1.8 TDCi 2006>2015, Galaxy 2.0 2006>2015, Galaxy 2.0 EcoBoost 2006>2015, Galaxy 2.0 Flexifuel 2006>2015, Galaxy 2.0 TDCi 2006>2015, Galaxy 2.2 TDCi 2006>2015, Galaxy 2.3 2006>2015, KUGA I 2.0 TDCi 2008>2012, KUGA I 2.0 TDCi 4x4 2008>2012, KUGA I 2.5 4x4 2008>2012, Mondeo IV 1.6 EcoBoost 2007>2015, Mondeo IV 1.6 TDCi 2007>2015, Mondeo IV 1.6 Ti 2007>2015, Mondeo IV 1.8 TDCi 2007>2015, Mondeo IV 2.0 2007>2015, Mondeo IV 2.0 EcoBoost 2007>2015, Mondeo IV 2.0 Flexifuel 2007>2015, Mondeo IV 2.0 LPG 2007>2015, Mondeo IV 2.0 SCTi 2007>2015, Mondeo IV 2.0 TDCi 2007>2015, Mondeo IV 2.2 TDCi 2007>2015, Mondeo IV 2.3 2007>2015, Mondeo IV 2.5 2007>2015, Mondeo IV Saloon 1.6 EcoBoost 2007>2015, Mondeo IV Saloon 1.6 TDCi 2007>2015, Mondeo IV Saloon 1.6 Ti 2007>2015, Mondeo IV Saloon 1.8 TDCi 2007>2015, Mondeo IV Saloon 2.0 2007>2015, Mondeo IV Saloon 2.0 EcoBoost 2007>2015, Mondeo IV Saloon 2.0 Flexifuel 2007>2015, Mondeo IV Saloon 2.0 LPG 2007>2015, Mondeo IV Saloon 2.0 SCTi 2007>2015, Mondeo IV Saloon 2.0 TDCi 2007>2015, Mondeo IV Saloon 2.2 TDCi 2007>2015, Mondeo IV Saloon 2.3 2007>2015, Mondeo IV Saloon 2.5 2007>2015, Mondeo IV Turnier 1.6 EcoBoost 2007>2015, Mondeo IV Turnier 1.6 TDCi 2007>2015, Mondeo IV Turnier 1.6 Ti 2007>2015, Mondeo IV Turnier 1.8 TDCi 2007>2015, Mondeo IV Turnier 2.0 2007>2015, Mondeo IV Turnier 2.0 EcoBoost 2007>2015, Mondeo IV Turnier 2.0 Flexifuel 2007>2015, Mondeo IV Turnier 2.0 LPG 2007>2015, Mondeo IV Turnier 2.0 SCTi 2007>2015, Mondeo IV Turnier 2.0 TDCi 2007>2015, Mondeo IV Turnier 2.2 TDCi 2007>2015, Mondeo IV Turnier 2.3 2007>2015, Mondeo IV Turnier 2.5 2007>2015, Mondeo IV Van 1.6 EcoBoost 2007>2014, Mondeo IV Van 1.6 TDCi 2007>2014, Mondeo IV Van 2.0 2007>2014, Mondeo IV Van 2.0 EcoBoost 2007>2014, Mondeo IV Van 2.0 TDCi 2007>2014, Mondeo IV Van 2.2 TDCi 2007>2014, Mondeo V Saloon 2.0 EcoBoost 2012>2016, S-MAX 1.6 EcoBoost 2006>2014, S-MAX 1.6 TDCi 2006>2014, S-MAX 1.8 TDCi 2006>2014, S-MAX 2.0 2006>2014, S-MAX 2.0 EcoBoost 2006>2014, S-MAX 2.0 Flexifuel 2006>2014, S-MAX 2.0 TDCi 2006>2014, S-MAX 2.2 TDCi 2006>2014, S-MAX 2.3 2006>2014, S-MAX 2.5 ST 2006>2014, C-Max II 1.0 EcoBoost 2010>1900, C-Max II 1.5 EcoBoost 2010>1900, C-Max II 1.5 TDCi 2010>1900, C-Max II 1.5 TDCi Econetic 2010>1900, C-Max II 1.6 CNG 2010>1900, C-Max II 1.6 EcoBoost 2010>1900, C-Max II 1.6 Flexifuel 2010>1900, C-Max II 1.6 LPG 2010>1900, C-Max II 1.6 TDCi 2010>1900, C-Max II 1.6 Ti 2010>1900, C-Max II Van 1.6 EcoBoost 2010>1900, C-Max II Van 1.6 TDCi 2010>1900, C-Max II Van 2.0 TDCi 2010>1900, Focus C-Max 1.8 Flexifuel 2003>2007, Focus II 2.5 RS 2004>2013, Focus II 2.5 RS 500 2004>2013, GRAND C-Max 1.6 EcoBoost 2010>1900, GRAND C-Max 1.6 TDCi 2010>1900, GRAND C-Max 1.6 Ti 2010>1900, GRAND C-Max 2.0 TDCi 2010>1900, GRAND C-Max Van 1.6 EcoBoost 2010>1900, GRAND C-Max Van 1.6 TDCi 2010>1900, GRAND C-Max Van 2.0 TDCi 2010>1900, KUGA I 2.5 EcoBoost 2012, FORDA: Focus Coupe 2.0 i 2007>2009, Focus Hatchback 2.0 i 2007>2009, Focus Hatchback 2.0 TDCi 2007>2009, Focus Hatchback 2.0 i 2009>2011, Focus Hatchback 2.0 TDCi 2009>2011, Focus Hatchback 2.5 i XR5 Turbo 2009>2011, Focus Saloon 2.0 i 2005>2009, Focus Saloon 2.0 TDCi 2009>2011, Mondeo Estate 2.3 i 16 V 2009>2014, Mondeo Hatchback 2.0 TDCi 2007>2015, Mondeo Hatchback 2.3 i 16 V 2007>2015, Mondeo Hatchback XR5 Turbo 2007>2015, Mondeo Saloon 2.0 TDCi 2007>2015, Mondeo Saloon 2.3 i 16 V 2007>2015;

ASTON MARTIN: Vanquish Vantage 6.0 S 2004>2007

GS2177 // NEW //

FRONT WHEEL SENSOR (RIGHT SIDE)

REPLACES / REEMPLAZA:

Ford: F65Z2C204CA, F65Z2C204FA, XL3Z2C204BA, XL3Z2C204BB, XL3Z2C204BC

APPLICATION / APLICACIÓN:

FORD: F250 4x2 1997>1999



GS2179 // NEW //

FRONT WHEEL SENSOR (RIGHT SIDE)

REPLACES / REEMPLAZA:

Ford: 7T4Z2C204A, 7T4Z2C204B, 9T4Z2C204A, 9T4Z2C204B, DT4Z2C204A, DT4Z2C204AB; **Mobiletron:** AB-US064

APPLICATION / APLICACIÓN:

FORD USA: Edge 2.0 AWD 2006>1900, Edge 3.5 2006>1900, Edge 3.5 AWD 2006>1900;

LINCOLN: MKX 3.5 AWD 2006>1900



GS2182 // NEW //

REAR WHEEL SENSOR (BOTH SIDES)

REPLACES / REEMPLAZA:

Ford: 98AG2B372CC; **Bosch:** 0 986 594 515; **Delphi:** SS20052; **Cargo:** 182340; **Meat & Doria:** 90095;

Mobiletron: AB-EU069

APPLICATION / APLICACIÓN:

FORD: Focus 1.4 16V 1998>0, Focus 1.6 16V 1998>0, Focus 1.6 16V Flexifuel 2002>0, Focus 1.6 Glx 8V Flex 2007>0, Focus 1.8 16V 1998>0, Focus 1.8 16V Bifuel 2002>0, Focus 1.8 Di / Tddi 1999>0, Focus 1.8 Tddi 2001>0, Focus 1.8 Turbo Di / Tddi 1998>0, Focus 2.0 2005>0, Focus 2.0 16V 1998>0, Focus Rs 2002>0, Focus St170 2002>0, Focus Box Body/Estate 1.4 1999>0, Focus Box Body/Estate 1.6 1999>0, Focus Box Body/Estate 1.8 1999>0, Focus Box Body/Estate 1.8 Tddi 2001>0, Focus Box Body/Estate 1.8 Tddi 1998>0, Focus II 2.0 2005>0, Focus II Saloon 2.0 2005>0, Focus Saloon 1.4 1.6 16V 1998>0, Focus Saloon 1.6 16V 1998>0, Focus Saloon 1.6 Glx 8V Flex 2007>0, Focus Saloon 1.8 16V 1998>0, Focus Saloon 1.8 Tddi 2001>0, Focus Saloon 1.8 Turbo Di / Tddi 1998>0, Focus Saloon 2.0 2005>0, Focus Saloon 2.0 16V 1998>0, Focus Turnier 1.4 16V 1998>0, Focus Turnier 1.6 16V 1998>0, Focus Turnier 1.6 16V Flexifuel 2002>0, Focus Turnier 1.8 16V 1998>0, Focus Turnier 1.8 Bifuel 2003>0, Focus Turnier 1.8 Di / Tddi 1999>0, Focus Turnier 1.8 Tddi 2001>0, Focus Turnier 1.8 Turbo Di / Tddi 1998>0, Focus Turnier 2.0 16V 1998>0, Focus Turnier St170 2002>0, Focus Hatchback 1.8 I 2002>0, Focus Hatchback 2.0 I 2002>0, Focus Hatchback 2.0 I St170 2003>0, Focus Saloon 1.8 I 2002>0



GS2183 // NEW //
FRONT WHEEL SENSOR (BOTH SIDES)
REPLACES / REEMPLAZA:
Ford: 97BG2B372AA, 98AG2B372AF, 2S652B372AA, 2S652B372AB; **Bosch:** 0 986 594 557; **Delphi:** SS20304; **Meat & Doria:** 90236; **Mobiletron:** AB-US050

APPLICATION / APLICACIÓN:
FORD: Fusion 1.25 2004>0, Fusion 1.4 2002>0, Fusion 1.4 Lpg 2010>0, Fusion 1.4 Tdci 2002>0, Fusion 1.6 2002>0, Fusion 1.6 Tdci 2004>0

GS2184 // NEW //
REAR WHEEL SENSOR (RIGHT SIDE)
REPLACES / REEMPLAZA:
Ford: 6C112B372BB, 6C112B372B, 6C112B372BD, 6C112B372BE, 1371544, 1383551, 13857799, 1785282; **Bosch:** 0 265 007 876; **Meat & Doria:** 90221; **Mobiletron:** AB-EU020

APPLICATION / APLICACIÓN:
FORD: Transit Box 2.2 TDCi 2006>2014, Transit Box 2.2 TDCi 4x4 2006>2014, Transit Box 2.2 TDCi RWD 2006>2014, Transit Box 2.3 16V CNG RWD 2006>2014, Transit Box 2.3 16V LPG RWD 2006>2014, Transit Box 2.3 16V RWD 2006>2014, Transit Box 2.4 TDCi 4x4 2006>2014, Transit Box 2.4 TDCi RWD 2006>2014, Transit Box 3.2 TDCi RWD 2006>2014, Transit Bus 2.2 TDCi 2006>2014, Transit Bus 2.2 TDCi RWD 2006>2014, Transit Bus 2.4 TDCi 2006>2014, Transit Bus 2.4 TDCi 4x4 2006>2014, Transit Bus 3.2 TDCi 2006>2014, Transit Platparam/Chassis 2.2 TDCi 2006>2014, Transit Platparam/Chassis 2.2 TDCi 4x4 2006>2014, Transit Platparam/Chassis 2.2 TDCi RWD 2006>2014, Transit Platparam/Chassis 2.3 16V CNG RWD 2006>2014, Transit Platparam/Chassis 2.3 16V LPG RWD 2006>2014, Transit Platparam/Chassis 2.3 16V RWD 2006>2014, Transit Platparam/Chassis 2.4 TDCi 4x4 2006>2014, Transit Platparam/Chassis 2.4 TDCi RWD 2006>2014, Transit Platparam/Chassis 3.2 TDCi RWD 2006>2014, Transit Tourneo 2.2 TDCi 2006>2014

GS2185 // NEW //
REAR WHEEL SENSOR (LEFT SIDE)
REPLACES / REEMPLAZA:
Ford: 6C112B372CB, 6C112B372C, 6C112B372CD, 6C112B372CE, 1371545, 1383552, 1385800, 1785284; **Delphi:** SS20165; **Magneti Marelli:** 172100092010; **Meat & Doria:** 90220, 90220E; **Mobiletron:** AB-EU023

APPLICATION / APLICACIÓN:
FORD: Transit Box 2.2 TDCi 2006>2014, Transit Box 2.2 TDCi 4x4 2006>2014, Transit Box 2.2 TDCi RWD 2006>2014, Transit Box 2.3 16V CNG RWD 2006>2014, Transit Box 2.3 16V LPG RWD 2006>2014, Transit Box 2.3 16V RWD 2006>2014, Transit Box 2.4 TDCi 4x4 2006>2014, Transit Box 2.4 TDCi RWD 2006>2014, Transit Box 3.2 TDCi RWD 2006>2014, Transit Bus 2.2 TDCi 2006>2014, Transit Bus 2.2 TDCi RWD 2006>2014, Transit Bus 2.4 TDCi 2006>2014, Transit Bus 2.4 TDCi 4x4 2006>2014, Transit Bus 2.4 TDCi RWD 2006>2014, Transit Platparam/Chassis 2.2 TDCi 2006>2014, Transit Platparam/Chassis 2.2 TDCi 4x4 2006>2014, Transit Platparam/Chassis 2.2 TDCi RWD 2006>2014, Transit Platparam/Chassis 2.3 16V CNG RWD 2006>2014, Transit Platparam/Chassis 2.3 16V LPG RWD 2006>2014, Transit Platparam/Chassis 2.3 16V RWD 2006>2014, Transit Platparam/Chassis 2.4 TDCi 4x4 2006>2014, Transit Platparam/Chassis 2.4 TDCi RWD 2006>2014, Transit Platparam/Chassis 3.2 TDCi RWD 2006>2014, Transit Tourneo 2.2 2006>2014, Transit Tourneo 2.2 TDCi 2006>2014

GS2186 // NEW //
FRONT WHEEL SENSOR (BOTH SIDES)
REPLACES / REEMPLAZA:
Ford: 6C112B372AA, 6C112B372AB, 6C112B372A, 1371543, 1385797, 1785753; **Delphi:** SS20205; **Meat & Doria:** 90219, 90219A1, 90219E; **Mobiletron:** AB-EU008

APPLICATION / APLICACIÓN:
FORD: Transit Box 2.2 TDCi 2006>2014, Transit Box 2.2 TDCi 4x4 2006>2014, Transit Box 2.2 TDCi RWD 2006>2014, Transit Box 2.3 16V CNG RWD 2006>2014, Transit Box 2.3 16V LPG RWD 2006>2014, Transit Box 2.3 16V RWD 2006>2014, Transit Box 2.4 TDCi 4x4 2006>2014, Transit Box 2.4 TDCi RWD 2006>2014, Transit Box 3.2 TDCi RWD 2006>2014, Transit Bus 2.2 TDCi 2006>2014, Transit Bus 2.2 TDCi RWD 2006>2014, Transit Bus 2.4 TDCi 2006>2014, Transit Bus 2.4 TDCi 4x4 2006>2014, Transit Bus 3.2 TDCi 2006>2014, Transit Platparam/Chassis 2.2 TDCi 2006>2014, Transit Platparam/Chassis 2.2 TDCi 4x4 2006>2014, Transit Platparam/Chassis 2.2 TDCi RWD 2006>2014, Transit Platparam/Chassis 2.3 16V CNG RWD 2006>2014, Transit Platparam/Chassis 2.3 16V LPG RWD 2006>2014, Transit Platparam/Chassis 2.3 16V RWD 2006>2014, Transit Platparam/Chassis 2.4 TDCi 4x4 2006>2014, Transit Platparam/Chassis 2.4 TDCi RWD 2006>2014, Transit Platparam/Chassis 3.2 TDCi RWD 2006>2014, Transit Tourneo 2.2 2006>2014, Transit Tourneo 2.2 TDCi 2006>2014

GS2188 // NEW //
FRONT WHEEL SENSOR (BOTH SIDES)
REPLACES / REEMPLAZA:
Fiat: 46837685, 0265007518; **Delphi:** SS20579; **Meat & Doria:** 90037, 90037E; **Mobiletron:** AB-EU231

APPLICATION / APLICACIÓN:
FIAT: Punto 1.2 16V 80 (188.233, .235, .253, .255, .333, .353, .639,... 1999>2012, Punto 1.2 60 (188.030, .050, .130, .150, .230, .250) 1999>2012, Punto 1.2 Bifuel 1999>2012, Punto 1.2 Natural Power 1999>2012, Punto 1.2 Natural Power (188BXA1A) 1999>2012, Punto 1.3 JTD 16V 1999>2012, Punto 1.4 1999>2012, Punto 1.4 (188AXM1A, 188BXM1A) 1999>2012, Punto 1.8 130 HGT (188.738, .718) 1999>2012, Punto 1.9 DS 60 (188.031, .051, .231, .251) 1999>2012, Punto 1.9 JTD 1999>2012, Punto 1.9 JTD 80 (188.237, .257, .337, .357) 1999>2012, Punto EVO 1.2 2009>2012, Punto Van 1.2 60 2000>2009, Punto Van 1.3 JTD 2000>2009, Punto Van 1.9 D 60 2000>2009, Punto Van 1.9 JTD 2000>2009

GS2189 // NEW //
FRONT WHEEL SENSOR (LEFT SIDE)
REPLACES / REEMPLAZA:
Fiat: 46837686, 0265007610; **Delphi:** SS20578; **Meat & Doria:** 90038; **Mobiletron:** AB-EU243

APPLICATION / APLICACIÓN:
FIAT: Punto 1.2 16V 80 (188.233, .235, .253, .255, .333, .353, .639,... 1999>2012, Punto 1.2 60 (188.030, .050, .130, .150, .230, .250) 1999>2012, Punto 1.2 Bifuel 1999>2012, Punto 1.2 Natural Power 1999>2012, Punto 1.2 Natural Power (188BXA1A) 1999>2012, Punto 1.3 JTD 16V 1999>2012, Punto 1.4 1999>2012, Punto 1.4 (188AXM1A, 188BXM1A) 1999>2012, Punto 1.8 130 HGT (188.738, .718) 1999>2012, Punto 1.9 DS 60 (188.031, .051, .231, .251) 1999>2012, Punto 1.9 JTD 1999>2012, Punto 1.9 JTD 80 (188.237, .257, .337, .357) 1999>2012, Punto EVO 1.2 2009>2012, Punto Van 1.2 60 2000>2009, Punto Van 1.3 JTD 2000>2009, Punto Van 1.9 D 60 2000>2009, Punto Van 1.9 JTD 2000>2009

GS2190



REPLACES / REEMPLAZA:
Ford: YL8Z2C190AC; **Mazda:** EC024371YK
 APPLICATION / APLICACIÓN:
Ford: Escape
Mazda: Tribute 2.0/2.3/3.0

GS2191 // NEW //



REAR WHEEL SENSOR (LEFT SIDE)
 REPLACES / REEMPLAZA:
Mitsubishi: 4670A191; **Bremi:** 50868
 APPLICATION / APLICACIÓN:
Mitsubishi: Pajero IV Van 3.2 2007>, Shogun Pajero MK3 3.2/3.8 2007>
PS: set of GS2192

GS2192 // NEW //



REAR WHEEL SENSOR (RIGHT SIDE)
 REPLACES / REEMPLAZA:
Mitsubishi: 4670A192; **Bremi:** 50869
 APPLICATION / APLICACIÓN:
Mitsubishi: Pajero IV Van 3.2 2007>, Shogun Pajero MK3 3.2/3.8 2007>
PS: set of GS2191

GS2193 // NEW //



FRONT WHEEL SENSOR (RIGHT SIDE)
 REPLACES / REEMPLAZA:
Ford: DB392C204AD, DB392C204BD, AB312C204AC
 APPLICATION / APLICACIÓN:
FORD: Ranger 2013>

GS2194 // NEW //



FRONT WHEEL SENSOR (LEFT SIDE)
 REPLACES / REEMPLAZA:
Ford: DB392C205AD, DB392C205AB, AB312C205AC
 APPLICATION / APLICACIÓN:
FORD: Ranger 2013>

GS2195 // NEW //



REAR WHEEL SENSOR (RIGHT SIDE)
 REPLACES / REEMPLAZA:
Ford: DB392C190AC
 APPLICATION / APLICACIÓN:
FORD: Ranger 2013>

GS2196 // NEW //



REAR WHEEL SENSOR (LEFT SIDE)
 REPLACES / REEMPLAZA:
Ford: AB312C216AD
 APPLICATION / APLICACIÓN:
FORD: Ranger 2013>

GS2198 // NEW //



FRONT WHEEL SENSOR (BOTH SIDES)
 REPLACES / REEMPLAZA:
Ford: AE8Z2C204A, 8V52C204J, 2S652B372AB, AE8Z2C204B, 8V512C204CB, 8V512C204CA, H3B52C204AA
 APPLICATION / APLICACIÓN:
FORD: B-Max 1.0 Ecoboost 2012>0, B-Max 1.4 2008>0, B-Max 1.4 Lpg 2009>0, B-Max 1.5 Tdci 2012>0, B-Max 1.6 Tdci 2012>0, B-Max 1.6 Ti 2008>0, B-Max Van 1.0 Ecoboost 2012>0, B-Max Van 1.4 2008>0, B-Max Van 1.5 Tdci 2012>0, B-Max Van 1.6 Tdci 2012>0, B-Max Van 1.6 Ti 2008>0, Fiesta Vi 1.0 2012>0, Fiesta Vi 1.0 Ecoboost 2012>0, Fiesta Vi 1.0 Sport 2014>0, Fiesta Vi 1.25 2008>0, Fiesta Vi 1.4 2008>0, Fiesta Vi 1.4 Lpg 2009>0, Fiesta Vi 1.5 Tdci 2012>0, Fiesta Vi 1.6 St 2013>0, Fiesta Vi 1.6 St200 2016>0, Fiesta Vi 1.6 Ti 2008>0, Fiesta Vi Van 1.0 2012>0, Fiesta Vi Van 1.0 Ecoboost 2012>0, Fiesta Vi Van 1.25 2008>0, Fiesta Vi Van 1.5 Tdci 2012>0, Fiesta Vi Van 1.6 St 2013>0, Fiesta Vii 1.0 Ecoboost 2012>0, Tourneo Courier B460 Kombi 1.0 Ecoboost 2012>0, Tourneo Courier B460 Kombi 1.5 Tdci 2012>0, Tourneo Courier B460 Kombi 1.6 Tdci 2012>0, Transit Courier B460 Box 1.0 Ecoboost 2012>0, Transit Courier B460 Box 1.5 Tdci 2012>0, Transit Courier B460 Box 1.6 Tdci 2012>0, Transit Courier B460 Kombi 1.0 Ecoboost 2012>0, Transit Courier B460 Kombi 1.5 Tdci 2012>0, Transit Courier B460 Kombi 1.6 Tdci 2012>0

GS2199 // NEW //
REAR WHEEL SENSOR (BOTH SIDES)

REPLACES / REEMPLAZA:

Ford: 2N152B372BA

APPLICATION / APLICACIÓN:

FORD: Ecosport (4x2) 2003>2012

GS2200 // NEW //
REAR WHEEL SENSOR (BOTH SIDES)

REPLACES / REEMPLAZA:

Ford: 97BG2B372BA; **Delphi:** SS20105; **Meat & Doria:** 90128; **Mobiletron:** AB-US073

APPLICATION / APLICACIÓN:

FORD: Cougar 2.0 16V 1998>0, Cougar 2.5 St 200 1999>0, Cougar 2.5 V6 24V 1998>0, Mondeo I 1.6 I 16V 1993>0, Mondeo I 1.8 I 16V 1993>0, Mondeo I 1.8 I 16V 4X4 1993>0, Mondeo I 1.8 Td 1993>0, Mondeo I 2.0 I 16V 1993>0, Mondeo I 2.0 I 16V 4X4 1993>0, Mondeo I 2.5 I 24V 1994>0, Mondeo I Saloon 1.6 I 16V 1993>0, Mondeo I Saloon 1.8 4X4 1993>0, Mondeo I Saloon 1.8 I 16V 1993>0, Mondeo I Saloon 1.8 Td 1993>0, Mondeo I Saloon 2.0 I 16V 1993>0, Mondeo I Saloon 2.0 I 16V 4X4 1993>0, Mondeo I Saloon 2.5 I 24V 1994>0, Mondeo I Turnier 1.6 I 16V 1993>0, Mondeo I Turnier 1.8 I 16V 1993>0, Mondeo I Turnier 1.8 I 16V 4X4 1993>0, Mondeo I Turnier 1.8 Td 1993>0, Mondeo I Turnier 2.0 I 16V 1993>0, Mondeo I Turnier 2.0 I 16V 4X4 1993>0, Mondeo I Turnier 2.5 I 24V 1994>0, Mondeo li 1.6 I 1996>0, Mondeo li 1.6 I 16V 1993>0, Mondeo li 1.8 I 1996>0, Mondeo li 1.8 Td 1993>0, Mondeo li 2.0 I 1996>0, Mondeo li 2.5 24V 1996>0, Mondeo li 2.5 St 200 1999>0, Mondeo li Saloon 1.6 I 1996>0, Mondeo li Saloon 1.6 I 16V 1993>0, Mondeo li Saloon 1.8 I 1996>0, Mondeo li Saloon 1.8 Td 1993>0, Mondeo li Saloon 2.0 I 1996>0, Mondeo li Saloon 2.5 24V 1996>0, Mondeo li Saloon 2.5 St 200 1999>0

GS2202 // NEW //
REAR WHEEL SENSOR (BOTH SIDES)

REPLACES / REEMPLAZA:

Ford: 8V512C204AB; **Bosch:** 0 265 008 128;

Meat & Doria: 90358

APPLICATION / APLICACIÓN:

FORD: Fiesta Vi 1.5 Flex 2013>0, Fiesta Vi 1.6 Flex 2013>0

GS2204
FRONT WHEEL SENSOR (LEFT SIDE)

REPLACES / REEMPLAZA:

Ford: F75Z2C204CA, XL3Z2C205AA, XL3Z2C205AB, XL3Z2C205AC

APPLICATION / APLICACIÓN:

Ford: Expedition, F-100, F-150, F-250, F-350

GS2205
FRONT WHEEL SENSOR (LEFT SIDE)

REPLACES / REEMPLAZA:

Ford / Lincoln: DT4Z-2C205-AB, 7T4Z2C205A, 7T4Z2C205B, 9T4Z2C205A, 9T4Z2C205B, DT4Z2C205A

APPLICATION / APLICACIÓN:

Ford: Edge 2007>2014

Lincoln: MKX 2007>2014

GS2210
FRONT WHEEL SENSOR (LEFT SIDE)

REPLACES / REEMPLAZA:

Chevrolet: 9069210

APPLICATION / APLICACIÓN:

Chevrolet: New Sail 2010>2012

PS: set of GS2211/ GS2212

GS2211
FRONT WHEEL SENSOR (RIGHT SIDE)

REPLACES / REEMPLAZA:

Chevrolet: 9069211

APPLICATION / APLICACIÓN:

Chevrolet: New Sail 2010>2012

PS: set of GS2210/ GS2212

GS2212
REAR WHEEL SENSOR

REPLACES / REEMPLAZA:

Chevrolet: 9069212

APPLICATION / APLICACIÓN:

Chevrolet: New Sail 2010>2012

PS: set of GS2210/ GS2211

GS2224
FRONT WHEEL SENSOR

REPLACES / REEMPLAZA:

Bosch: 0 986 594 024

Ford: 97KG2B372AA, 1038224

APPLICATION / APLICACIÓN:

Ford: Ka 1.3/1.6, Street Ka convertible 1.6



GS2225 // NEW //

FRONT WHEEL SENSOR (BOTH SIDES)

REPLACES / REEMPLAZA:

GM: 09115064, 0986594027; **Bosch:** 0 986 594 027;

Meat & Doria: 90009; **Mobiletron:** AB-EU019

APPLICATION / APLICACIÓN:

HOLDEN: Combo Box 1.4 i 2005>2012, Tigrá 1.8 2005>2007;

OPEL: Combo Box Body/Estate 1.3 CDTI 16V 2001>2012, Combo Box Body/Estate 1.4 16V 2001>2012, Combo Box Body/Estate 1.6 2001>2012, Combo Box Body/Estate 1.6 CNG 16V 2001>2012, Combo Box Body/Estate 1.7 CDTI 16V 2001>2012, Combo Box Body/Estate 1.7 DTI 16V 2001>2012, Combo Tour 1.3 CDTI 16V 2001>2011, Combo Tour 1.4 2001>2011, Combo Tour 1.6 2001>2011, Combo Tour 1.6 CNG 2001>2011, Combo Tour 1.7 CDTI 16V 2001>2011, Combo Tour 1.7 DI 16V 2001>2011, Combo Tour 1.7 DTI 16V 2001>2011, Corsa C 1.0 (F08, F68) 2000>2009, Corsa C 1.2 (F08, F68) 2000>2009, Corsa C 1.2 Twinport (F08, F68) 2000>2009, Corsa C 1.3 CDTI (F08, F68) 2000>2009, Corsa C 1.4 (F08, F68) 2000>2009, Corsa C 1.4 Twinport (F08, F68) 2000>2009, Corsa C 1.6 (F08, F68) 2000>2009, Corsa C 1.7 CDTI (F08, F68) 2000>2009, Corsa C 1.7 DI (F08, F68) 2000>2009, Corsa C 1.7 DTI (F08, F68) 2000>2009, Corsa C 1.8 (F08, F68) 2000>2009, Corsa C Box 1.2 (F08, W5L) 2000>2012, Corsa C Box 1.2 16V (F08, W5L) 2000>2012, Corsa C Box 1.3 CDTI 16V (F08, W5L) 2000>2012, Corsa C Box 1.4 (W5L, F08) 2000>2012, Corsa C Box 1.7 CDTI (F08, W5L) 2000>2012, Corsa C Box 1.7 DI 16V (F08, W5L) 2000>2012, Corsa C Box 1.7 DTI 16V (F08, W5L) 2000>2012, Corsa Classic Saloon 1.4 2000>2003, Corsa Utility Pickup 1.4 2000>2010, Corsa Utility Pickup 1.7 Di 2000>2010, Corsa Utility Pickup 1.7 DTI 2000>2010, Meriva A MPV 1.3 CDTI (E75) 2003>2010, Meriva A MPV 1.4 16V Twinport (E75) 2003>2010, Meriva A MPV 1.4 16V Twinport LPG (E75) 2003>2010, Meriva A MPV 1.6 (E75) 2003>2010, Meriva A MPV 1.6 16V (E75) 2003>2010, Meriva A MPV 1.6 Turbo (E75) 2003>2010, Meriva A MPV 1.6 Turbo (E75) 2003>2010, Meriva A MPV 1.7 CDTI (E75) 2003>2010, Meriva A MPV 1.7 DTI (E75) 2003>2010, Meriva A MPV 1.8 (E75) 2003>2010, Tigrá TwinTop 1.3 CDTI (R97) 2004>2010, Tigrá TwinTop 1.4 (R97) 2004>2010, Tigrá TwinTop 1.8 (R97) 2004>2010, Combo 1.4 16V 1994>2001;

VAUXHALL: Combo Mk II 1.3 CDTI 16V 2001>2012, Combo Mk II 1.4 16V 2001>2012, Combo Mk II 1.4 i 16V 2001>2012, Combo Mk II 1.6 2001>2012, Combo Mk II 1.6 CNG 16V 2001>2012, Combo Mk II 1.7 CDTI 16V 2001>2012, Combo Mk II 1.7 DI 16V 2001>2012, Combo Mk II 1.7 DTI 16V 2001>2012, Combo TOUR Mk II 1.3 CDTI 16V 2001>2012, Combo TOUR Mk II 1.4 2001>2012, Combo TOUR Mk II 1.6 2001>2012, Combo TOUR Mk II 1.6 CNG 2001>2012, Combo TOUR Mk II 1.7 CDTI 16V 2001>2012, Combo TOUR Mk II 1.7 DI 16V 2001>2012, Combo TOUR Mk II 1.7 DTI 16V 2001>2012, Corsa Mk II 1.0 12V (F08, F68) 2000>2006, Corsa Mk II 1.2 16V (F08, F68) 2000>2006, Corsa Mk II 1.2 16V Dualfuel (F08, F68) 2000>2006, Corsa Mk II 1.2 Twinport (F08, F68) 2000>2006, Corsa Mk II 1.3 CDTI 16V (F08, F68) 2000>2006, Corsa Mk II 1.4 16V (F08, F68) 2000>2006, Corsa Mk II 1.4 Twinport (F08, F68) 2000>2006, Corsa Mk II 1.7 DI 16V (F08, F68) 2000>2006, Corsa Mk II 1.7 DTI 16V (F08, F68) 2000>2006, Corsa Mk II 1.8 16V (F08, F68) 2000>2006, CorsaVan Mk II 1.2 16V (F08) 2000>2006, CorsaVan Mk II 1.2 16V Dualfuel (F08) 2000>2006, CorsaVan Mk II 1.3 CDTI 16V (F08) 2000>2006, CorsaVan Mk II 1.4 (F08) 2000>2006, CorsaVan Mk II 1.7 DI 16V (F08) 2000>2006, CorsaVan Mk II 1.7 DTI 16V (F08) 2000>2006, Meriva Mk I 1.3 CDTI 2003>2010, Meriva Mk I 1.4 16V Twinport 2003>2010, Meriva Mk I 1.6 i 2003>2010, Meriva Mk I 1.6 i 16V 2003>2010, Meriva Mk I 1.6 i 16V Twinport 2003>2010, Meriva Mk I 1.6 Turbo 2003>2010, Meriva Mk I 1.7 CDTI 2003>2010, Meriva Mk I 1.7 DTI 2003>2010, Meriva Mk I 1.8 i 16V 2003>2010, Tigrá TwinTop 1.4 2004>2010, Tigrá TwinTop 1.8 2004>2010, Corsa Mk II 1.7 CDTI 16V (F08, F68) 2000>2006;

CHEVROLET: Corsa Hatchback 1.0 Joy Flex 1994>2010, Corsa Hatchback 1.8 1994>2010, Corsa Hatchback 1.8 Flexpower 1994>2010, Corsa Saloon 1.0 1994>2010, Corsa Saloon 1.8 1994>2010, Corsa Saloon 1.8 Flex 1994>2010, Corsa Saloon 1.8 Flexpower 1994>2010, Corsa Saloon 1.8 Joy Flex 1994>2010, Meriva 1.8 2002>2012, Meriva 1.8 (75) 2002>2012, Meriva 1.8 Flex (75) 2002>2012, MONTANA Pickup 1.8 2003>2010, MONTANA Pickup 1.8 Flexpower (80) 2003>2010



GS2228 // NEW //

FRONT WHEEL SENSOR (BOTH SIDES)

REPLACES / REEMPLAZA:

GM: 90483637, 1238918, 90386504; **Bosch:** 0 986 594 028; **Delphi:** SS20219; **Meat & Doria:** 90074

APPLICATION / APLICACIÓN:

CHEVROLET: Combo 1.7 D 1994>0, Corsa Pickup 1.7 D 1994>0, Tigrá 1.6 16V 1994>0;

HOLDEN: Barina Hatchback 1.6 I 1994>0;

OPEL: Combo 1.2 1994>0, Combo 1.4 1994>0, Combo 1.4 16V 1994>0, Combo 1.7 D 1994>0, Corsa B 1.0 I 12V 1996>0, Corsa B 1.2 I 1993>0, Corsa B 1.2 I 16V 1998>0, Corsa B 1.4 I 1993>0, Corsa B 1.4 I 16V 1994>0, Corsa B 1.4 Si 1993>0, Corsa B 1.5 D 1993>0, Corsa B 1.5 Td 1993>0, Corsa B 1.6 Gsi 16V 1993>0, Corsa B 1.6 I 16V 1994>0, Corsa B 1.7 D 1996>0, Corsa B Box 1.2 1994>0, Corsa B Box 1.4 I 1999>0, Corsa B Box 1.5 D 1994>0, Corsa B Box 1.7 D 1999>0, Corsa B Estate 1.4 I 16V 1999>0, Corsa B Estate 1.7 D 1999>0, Tigrá 1.4 16V 1994>0, Tigrá 1.6 16V 1994>0;

VAUXHALL: Combo Mk I 1.4 1994>0, Combo Mk I 1.7 D 1994>0, Corsa Mk I 1.0 I 12V 1996>0, Corsa Mk I 1.2 I 1993>0, Corsa Mk I 1.2 I 16V 1998>0, Corsa Mk I 1.4 I 1993>0, Corsa Mk I 1.4 I 16V 1994>0, Corsa Mk I 1.4 I S 1993>0, Corsa Mk I 1.5 D 1992>0, Corsa Mk I 1.5 Td 1993>0, Corsa Mk I 1.6 Gsi 16V 1993>0, Corsa Mk I 1.6 I 16V 1994>0, Corsa Mk I 1.7 D 1994>0, CorsaVan Mk I 1.4 I 1993>0, CorsaVan Mk I 1.5 D 1992>0, CorsaVan Mk I 1.7 D 1994>0, Tigrá Mk I 1.4 16V 1994>0, Tigrá Mk I 1.6 16V 1994>0



GS2229 // NEW //

REAR WHEEL SENSOR (BOTH SIDES)

REPLACES / REEMPLAZA:

GM: 90368505, 0986594025; **Bosch:** 0 986 594 025; **Delphi:** SS20142; **Meat & Doria:** 90073; **Mobiletron:** AB-EU240

APPLICATION / APLICACIÓN:

HOLDEN: Barina Hatchback 1.6 i 1994>1998;

CHEVROLET: Classic 1.6 2004>1900, Combo 1.7 D 2001>1900, Corsa Estate 1.6 GLS (35) 1997>2002, Corsa Estate 1.6 GS (35) 1997>2002, Corsa Hatchback 1.6 GLS (08, 68) 1994>2010, Corsa Hatchback 1.6 GSI 16V SFI (08) 1994>2010, Corsa Pickup 1.7 D 2000>2002, Corsa Saloon 1.6 1994>2010, Corsa Saloon 1.6 GLS (19) 1994>2010, Corsa Saloon 1.6 GLS 16V 1994>2010, Corsa Saloon 1.6 GS 1994>2010;

OPEL: Combo 1.2 1994>2001, Combo 1.4 1994>2001, Combo 1.4 16V 1994>2001, Combo 1.7 D 1994>2001, Corsa B 1.0 i 12V (F08, F68, M68) 1993>2000, Corsa B 1.2 i (F08, F68, M68) 1993>2000, Corsa B 1.2 i 16V (F08, F68, M68) 1993>2000, Corsa B 1.4 i (F08, F68, M68) 1993>2000, Corsa B 1.4 i 16V (F08, F68, M68) 1993>2000, Corsa B 1.4 Si (F08, F68, M68) 1993>2000, Corsa B 1.5 D (F08, F68, M68) 1993>2000, Corsa B 1.5 TD (F08, F68, M68) 1993>2000, Corsa B 1.6 GSI 16V (F08, F68, M68) 1993>2000, Corsa B 1.6 i 16V (F08, F68, M68) 1993>2000, Corsa B 1.7 D (F08, F68, M68) 1993>2000, Corsa B Box 1.2 (F08, W5L) 1994>2001, Corsa B Box 1.4 i (F08, W5L) 1994>2001, Corsa B Box 1.5 D (F08, W5L) 1994>2001, Corsa B Box 1.7 D (F08, W5L) 1994>2001, Corsa B Estate 1.4 i 16V (F35) 1999>2002, Corsa B Estate 1.7 D (F35) 1999>2002, TIGRA 1.4 16V (F07) 1994>2000, TIGRA 1.6 16V (F07) 1994>2000, Corsa B 1.4 (F08, F68, M68) 1993>2000;

VAUXHALL: Combo Mk I 1.4 1994>2001, Combo Mk I 1.7 D 1994>2001, Corsa Mk I 1.0 i 12V 1992>2000, Corsa Mk I 1.2 i 1992>2000, Corsa Mk I 1.2 i 16V 1992>2000, Corsa Mk I 1.4 i 1992>2000, Corsa Mk I 1.4 i 16V 1992>2000, Corsa Mk I 1.4 i S 1992>2000, Corsa Mk I 1.5 D 1992>2000, Corsa Mk I 1.5 TD 1992>2000, Corsa Mk I 1.6 GSI 16V 1992>2000, Corsa Mk I 1.6 i 16V 1992>2000, Corsa Mk I 1.7 D 1992>2000, CorsaVan Mk I 1.4 i 1994>2000, CorsaVan Mk I 1.5 D 1994>2000, TIGRA Mk I 1.4 16V 1994>2000, TIGRA Mk I 1.6 16V 1994>2000, CorsaVan Mk I 1.7 D 1994>2000

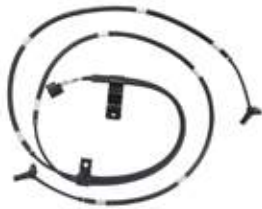
GS2233 // NEW //
REAR WHEEL SENSOR (BOTH SIDES)

REPLACES / REEMPLAZA:

GM: 94729230

APPLICATION / APLICACIÓN:

GM: Trailblazer 2012>2018

GS2239 // NEW //
REAR WHEEL SENSOR (LEFT SIDE)

REPLACES / REEMPLAZA:

Honda: 57475S8A53, 57475S0KA53; **Delphi:** SS10918

APPLICATION / APLICACIÓN:

HONDA: Accord Vi Coupe 3.0 V6 24V 1998>0

GS2240 // NEW //
REAR WHEEL SENSOR (RIGHT SIDE)

REPLACES / REEMPLAZA:

Honda: 57470S0KA51, 57470S0KA52, 57470S0KA53;

Delphi: SS10917

APPLICATION / APLICACIÓN:

HONDA: Accord Vi Coupe 3.0 V6 24V 1998>0

GS2242 // NEW //
REAR WHEEL SENSOR (LEFT SIDE)

REPLACES / REEMPLAZA:

Honda: 57475S5A013, 57475S5D003, 57475S5D013;

Bremi: 50087

APPLICATION / APLICACIÓN:

HONDA: CIVIC VII Coupe 1.6 I 2001>2005, CIVIC VII Coupe

1.7 2001>2005, CIVIC VII Saloon 1.7 (EU3) 2001>2005;

ACURA: EL 2001>2003, RSX 2002>2006

GS2243 // NEW //
FRONT WHEEL SENSOR (RIGHT SIDE)

REPLACES / REEMPLAZA:

Honda: 57450S5A013, 57450S5D003, 57450S5D013;

A.B.S.: 30838

APPLICATION / APLICACIÓN:

HONDA: Civic VII Coupe 1.7 I 2001>0, Civic VII Coupe 1.7

I Vtec 2001>0, Civic VII Hatchback 1.4 I 2001>0, Civic VII

Hatchback 1.4 Is 2001>0, Civic VII Hatchback 1.6 I 2001>0, Civic

VII Hatchback 1.7 Ctdi 2002>0, Civic VII Saloon 1.4 2000>0, Civic

VII Saloon 1.6 2001>0

GS2244 // NEW //
FRONT WHEEL SENSOR (LEFT SIDE)

REPLACES / REEMPLAZA:

Honda: 57450S5A013, 57450S5D003, 57450S5D013;

A.B.S.: 30836

APPLICATION / APLICACIÓN:

HONDA: Civic VII Coupe 1.7 I 2001>0, Civic VII Coupe 1.7

I Vtec 2001>0, Civic VII Hatchback 1.4 I 2001>0, Civic VII

Hatchback 1.4 Is 2001>0, Civic VII Hatchback 1.6 I 2001>0, Civic

VII Hatchback 1.7 Ctdi 2002>0, Civic VII Saloon 1.4 2000>0, Civic

VII Saloon 1.6 2001>0

GS2247 // NEW //
REAR WHEEL SENSOR (LEFT SIDE)

REPLACES / REEMPLAZA:

Honda: 57475SDAA03; **A.B.S.:** 31659

APPLICATION / APLICACIÓN:

HONDA: Accord Vii 2.0 2003>0, Accord Vii 2.2 I-Ctdi 2004>0,

Accord Vii 2.4 2003>0

GS2248 // NEW //
FRONT WHEEL SENSOR (RIGHT SIDE)

REPLACES / REEMPLAZA:

Honda: 57450SDAA01; **Mobiletron:** AB-JP093;

Bremi: 50683

APPLICATION / APLICACIÓN:

HONDA: Accord Coupe 2.4 (CM7) 2003>2008, Accord Coupe

3.0 V6 (CM7) 2003>2008, Accord VII 2.0 (CL7) 2003>2008,

Accord VII 2.0 All-wheel Drive (CL8) 2003>2008, Accord VII 2.0 R

2003>2008, Accord VII 2.2 i-CTDi (CN1) 2003>2008, Accord VII

2.4 (CL9) 2003>2008, Accord VII 2.4 Vtec E (CM5) 2002>2007,

Accord VII 3.0 2002>2007, Accord VII 3.0 (CM6) 2002>2007,

Accord VII 3.0 Hybrid 2002>2007, Accord VII Tourer 2.0 (CM1)

2003>2008, Accord VII Tourer 2.2 i-CTDi (CN2) 2003>2008,

Accord VII Tourer 2.4 (CM2) 2003>2008, Accord VII Tourer 2.4

Vtec T 2003>2008

GS2249 // NEW //
FRONT WHEEL SENSOR (LEFT SIDE)

REPLACES / REEMPLAZA:

Honda: 57455SDAA01; **Bremi:** 50682;

Mobiletron: AB-JP092

APPLICATION / APLICACIÓN:

HONDA: Accord Coupe 2.4 (CM7) 2003>2008, Accord Coupe

3.0 V6 (CM7) 2003>2008, Accord VII 2.0 (CL7) 2003>2008,

Accord VII 2.0 All-wheel Drive (CL8) 2003>2008, Accord VII

2.0 R 2003>2008, Accord VII 2.2 i-CTDi (CN1) 2003>2008,

Accord VII 2.4 (CL9) 2003>2008, Accord VII 2.4 Vtec E (CM5)

2002>2007, Accord VII 3.0 2002>2007, Accord VII 3.0 (CM6)

2002>2007, Accord VII 3.0 Hybrid 2002>2007, Accord VII Tourer

2.0 (CM1) 2003>2008, Accord VII Tourer 2.2 i-CTDi (CN2)

2003>2008, Accord VII Tourer 2.4 (CM2) 2003>2008, Accord VII

Tourer 2.4 Vtec T 2003>2008

GS2250 // NEW //
REAR WHEEL SENSOR (RIGHT SIDE)

REPLACES / REEMPLAZA:

Honda: 57470SDAA03; **A.B.S.:** 31660

APPLICATION / APLICACIÓN:

HONDA: Accord Vii 2.0 2003>0, Accord Vii 2.2 I-Ctdi 2004>0,

Accord Vii 2.4 2003>0

GS2251 // NEW //
FRONT WHEEL SENSOR (BOTH SIDES)
REPLACES / REEMPLAZA:
Honda: 57450S9A013, 57455SA9A003, 57455S9A013;

Meat & Doria: 90562

APPLICATION / APLICACIÓN:
HONDA: CR-V li 2.0 2001>0, CR-V li 2.2 Ctdi 2005>0, CR-V lii 2.2 I-Ctdi 4Wd 2007>0

GS2252 // NEW //
REAR WHEEL SENSOR (RIGHT SIDE)
REPLACES / REEMPLAZA:
Honda: 57470S9A013; **Meat & Doria:** 90564

APPLICATION / APLICACIÓN:
HONDA: CR-V li 2.0 2001>0, CR-V li 2.2 Ctdi 2005>0, CR-V lii 2.2 I-Ctdi 4Wd 2007>0

GS2253 // NEW //
REAR WHEEL SENSOR (LEFT SIDE)
REPLACES / REEMPLAZA:
Honda: 57475S9A013; **A.B.S.:** 31105;

Meat & Doria: 90563

APPLICATION / APLICACIÓN:
HONDA: CR-V li 2.0 2001>0, CR-V li 2.2 Ctdi 2005>0, CR-V lii 2.2 I-Ctdi 4Wd 2007>0

GS2254 // NEW //
FRONT WHEEL SENSOR (RIGHT SIDE)
REPLACES / REEMPLAZA:
Honda: 57450SXS003

APPLICATION / APLICACIÓN:
HONDA: CR-V lii 2.0 I-Vtec 2007>0, CR-V lii 2.0 I-Vtec 4Wd 2006>0, CR-V lii 2.2 I-Ctdi 4Wd 2007>0, CR-V lii 2.2 I-Dtec 4Wd 2007>0, CR-V lii 2.4 2006>0, CR-V lii 2.4 2007>0, CR-V lii 2.4 4Wd 2006>0, CR-V lii 2.4 I-Vtec 4Wd 2007>0, CR-V lii 2.4 I-Vtec 4Wd 2006>0, CR-V lii 2.4 I-Vtec 4Wd 2009>0, CR-V lii 2.0 2012>0

GS2255 // NEW //
REAR WHEEL SENSOR (RIGHT SIDE)
REPLACES / REEMPLAZA:
Honda: 57470SXS013, 57470SXS003; **A.B.S.:** 31292

APPLICATION / APLICACIÓN:
HONDA: CR-V lii 2.0 I-Vtec 2007>0, CR-V lii 2.0 I-Vtec 4Wd 2006>0, CR-V lii 2.2 I-Ctdi 4Wd 2007>0, CR-V lii 2.2 I-Dtec 4Wd 2007>0, CR-V lii 2.4 2006>0, CR-V lii 2.4 2007>0, CR-V lii 2.4 4Wd 2006>0, CR-V lii 2.4 I-Vtec 4Wd 2007>0, CR-V lii 2.4 I-Vtec 4Wd 2006>0, CR-V lii 2.4 I-Vtec 4Wd 2009>0, CR-V lii 2.0 2012>0

GS2256 // NEW //
FRONT WHEEL SENSOR (LEFT SIDE)
REPLACES / REEMPLAZA:
Hyundai: 598102H300, 598102L300; **A.B.S.:** 30870;

Meat & Doria: 90476; **Mobiletron:** AB-KR055

APPLICATION / APLICACIÓN:
HYUNDAI: I30 1.4 2007>0, I30 1.6 2007>0, I30 1.6 Crdi 2007>0, I30 2.0 2007>0, I30 2.0 Crdi 2007>0, I30 Estate 1.4 2007>0, I30 Estate 1.6 2007>0, I30 Estate 1.6 Crdi 2007>0, I30 Estate 2.0 2007>0, I30 Estate 2.0 Crdi 2007>0

GS2257 // NEW //
REAR WHEEL SENSOR (LEFT SIDE)
REPLACES / REEMPLAZA:
Hyundai: 599102H300; **A.B.S.:** 31406;

Meat & Doria: 90478

APPLICATION / APLICACIÓN:
HYUNDAI: I30 1.4 2007>0, I30 1.6 2007>0, I30 1.6 Crdi 2007>0, I30 2.0 2007>0, I30 2.0 Crdi 2007>0, I30 Estate 1.4 2007>0, I30 Estate 1.6 2007>0, I30 Estate 1.6 Crdi 2007>0, I30 Estate 2.0 2007>0, I30 Estate 2.0 Crdi 2007>0

GS2258
FRONT WHEEL SENSOR
REPLACES / REEMPLAZA:
Chevrolet: 1247004, 12842463, 13329258

Opel: 1247004, 12842463, 13329258

Vauxhall: 1247004, 12842463, 13329258

APPLICATION / APLICACIÓN:
Chevrolet: Cruze, Orlando, Volt

Opel: Ampera, Astra, Zafira

Vauxhall: Zafira

PS: set of GS2530

GS2262
FRONT WHEEL SENSOR (RIGHT SIDE)
REPLACES / REEMPLAZA:
Ford: F87Z 2C204FA, 3L5Z2C204AA, 6L5Z2C204AA

Mazda: ZZP043701, ZZP043701A, ZZP043701B

APPLICATION / APLICACIÓN:
Ford: Explorer

Mazda: B2300, B2500, B3000, B4000

PS: set of GS2884

GS2263
FRONT WHEEL SENSOR (RIGHT SIDE)
REPLACES / REEMPLAZA:
Mazda: ALS2019, GS3L4370X, SU13681

APPLICATION / APLICACIÓN:
Mazda: 6 2009>2012

PS: set of GS2293

GS2264 // NEW //
REAR WHEEL SENSOR (BOTH SIDES)
REPLACES / REEMPLAZA:
Honda: 57470TA0A03

APPLICATION / APLICACIÓN:
HONDA: Accord Viii 2.0 I 2008>2015, Accord Viii 2.2 I 2008>2015, Accord Viii Tourer 2.0 I 2008>, Accord Viii Tourer 2.4 I 2008>

GS2265 // NEW //
FRONT WHEEL SENSOR (RIGHT SIDE)
REPLACES / REEMPLAZA:
Honda: 57450TA0A01; **A.B.S.:** 31099

APPLICATION / APLICACIÓN:
HONDA: Accord Viii 2.0 I 2008>0, Accord Viii 2.2 I-Dtec 2008>0, Accord Viii 2.4 I 2008>0, Accord Viii Estate 2.0 I 2008>0, Accord Viii Estate 2.2 I-Dtec 2008>0, Accord Viii Estate 2.4 I 2008>0;

HONDA GAC: Accord Viii 2.0 2008>0

GS2266 // NEW //
FRONT WHEEL SENSOR (LEFT SIDE)

REPLACES / REEMPLAZA:

Honda: 57455TA0A01, 57455TR0013; **A.B.S.:** 31098

APPLICATION / APLICACIÓN:

HONDA: Accord VIII 2.0 I 2008>0, Accord VIII 2.2 I-Dtec 2008>0, Accord VIII 2.4 I 2008>0, Accord VIII Estate 2.0 I 2008>0, Accord VIII Estate 2.2 I-Dtec 2008>0, Accord VIII Estate 2.4 I 2008>0;

HONDA GAC: Accord VIII 2.0 2008>0

GS2267 // NEW //
FRONT WHEEL SENSOR (RIGHT SIDE)

REPLACES / REEMPLAZA:

Honda: 57450TR3A02, 57450TR0013; **A.B.S.:** 31674

APPLICATION / APLICACIÓN:

HONDA: Civic Ix Saloon 1.6 2011>0, Civic Ix Saloon 1.8 2011>0, Civic Ix Saloon 1.8 2012>0

GS2268 // NEW //
REAR WHEEL SENSOR (LEFT SIDE)

REPLACES / REEMPLAZA:

Honda: 57475TR3A02, 57475TR0013

APPLICATION / APLICACIÓN:

HONDA: Civic 2012>2015

GS2269 // NEW //
REAR WHEEL SENSOR (RIGHT SIDE)

REPLACES / REEMPLAZA:

Honda: 57470TR3A02, 57470TR0013

APPLICATION / APLICACIÓN:

HONDA: Civic 2012>2015

GS2270 // NEW //
FRONT WHEEL SENSOR (RIGHT SIDE)

REPLACES / REEMPLAZA:

Honda: 57450TF0003, 57450TJ0M01, 57455T7A003,

 57450T5R003; **A.B.S.:** 30826

APPLICATION / APLICACIÓN:

HONDA: City Saloon 1.4 I-V Tec 2008>0, Cr-Z 1.5 Hybrid 2010>0, Insight 1.3 Hybrid 2009>0, Jazz Iii 1.2 2008>0, Jazz Iii 1.3 Hybrid 2011>0, Jazz Iii 1.3 I 2008>0, Jazz Iii 1.4 2008>0

GS2271 // NEW //
REAR WHEEL SENSOR (LEFT SIDE)

REPLACES / REEMPLAZA:

Honda: 57475TF0003; **A.B.S.:** 30827

APPLICATION / APLICACIÓN:

HONDA: City Saloon 1.4 I-V Tec 2008>0, Jazz Iii 1.2 2008>0, Jazz Iii 1.3 Hybrid 2011>0, Jazz Iii 1.3 I 2008>0, Jazz Iii 1.4 2008>0

GS2273 // NEW //
REAR WHEEL SENSOR (RIGHT SIDE)

REPLACES / REEMPLAZA:

Honda: 57470TF0013; **A.B.S.:** 30830

APPLICATION / APLICACIÓN:

HONDA: City Saloon 1.4 I-V Tec 2008>0, Jazz Iii 1.2 2008>0, Jazz Iii 1.3 Hybrid 2011>0, Jazz Iii 1.3 I 2008>0, Jazz Iii 1.4 2008>0

GS2274 // NEW //
FRONT WHEEL SENSOR (LEFT SIDE)

REPLACES / REEMPLAZA:

Honda: 57455SNA003, 57455SNA013; **A.B.S.:** 30839;

Meat & Doria: 90557; **Mobiletron:** AB-JP006

APPLICATION / APLICACIÓN:

HONDA: Civic VIII Saloon 1.3 Hybrid 2006>0, Civic VIII Saloon 1.3 Hybrid 2010>0, Civic VIII Saloon 1.6 2005>0, Civic VIII Saloon 1.8 2005>0, Civic VIII Saloon 1.8 Exs Flex 2006>0

GS2275 // NEW //
REAR WHEEL SENSOR (LEFT SIDE)

REPLACES / REEMPLAZA:

Honda: 57475SNA003, 57475SNA013, 57475SNA023;

A.B.S.: 30841; **Delphi:** SS20626; **Meat & Doria:** 90559;

Mobiletron: AB-JP099

APPLICATION / APLICACIÓN:

HONDA: Civic VIII Saloon 1.3 Hybrid 2005>0, Civic VIII Saloon 1.3 Hybrid 2006>0, Civic VIII Saloon 1.3 Hybrid 2010>0, Civic VIII Saloon 1.6 2005>0, Civic VIII Saloon 1.8 2005>0, Civic VIII Saloon 1.8 Cng 2005>0

GS2276 // NEW //
FRONT WHEEL SENSOR (RIGHT SIDE)

REPLACES / REEMPLAZA:

Honda: 57450SLNA01

APPLICATION / APLICACIÓN:

HONDA: Fit 2006>2008

GS2277 // NEW //
FRONT WHEEL SENSOR (LEFT SIDE)

REPLACES / REEMPLAZA:

Honda: 57455SLNA01

APPLICATION / APLICACIÓN:

HONDA: Fit 2006>2008

GS2281 // NEW //
FRONT WHEEL SENSOR (RIGHT SIDE)

REPLACES / REEMPLAZA:

Honda: 57450T7A003

APPLICATION / APLICACIÓN:

HONDA: HR-V 2016>



GS2282 // NEW //

REAR WHEEL SENSOR (RIGHT SIDE)

REPLACES / REEMPLAZA:

Honda: 57470T5R023

APPLICATION / APLICACIÓN:

HONDA: Fit 2015>2017



GS2283 // NEW //

REAR WHEEL SENSOR (LEFT SIDE)

REPLACES / REEMPLAZA:

Honda: 57475T5R033

APPLICATION / APLICACIÓN:

HONDA: Fit 2015>2017



GS2284

FRONT WHEEL SENSOR (RIGHT SIDE)

REPLACES / REEMPLAZA:

Nissan: 479105Y700, 479105Y705

APPLICATION / APLICACIÓN:

Nissan: Maxima 2002>2003

PS: set of GS2725

PS: set of GS2262



GS2285 // NEW //

REAR WHEEL SENSOR (BOTH SIDES)

REPLACES / REEMPLAZA:

Peugeot: 96217753/ 454536/ 454546/ 454562/ 96218046/ 96183217/ 96272628/ 454556/ 96089629/ 454533/ 0265006202/ 0265006209/ 0265003129/ 0265003079/ 0265006205;

Bosch: SS20179; Meat & Doria: 90290; Mobiletron: AB-EU266

APPLICATION / APLICACIÓN:

CITROËN: Xsara 1.4 Hdi 2003>0, Xsara 1.4 I 1997>0, Xsara 1.4 Lpg 1998>0, Xsara 1.5 D 1997>0, Xsara 1.6 16V 2000>0, Xsara 1.6 I 1997>0, Xsara 1.8 Bifuel 1997>0, Xsara 1.8 D 1997>0, Xsara 1.8 I 1992>0, Xsara 1.8 I 16V 1996>0, Xsara 1.8 I Aut. 1997>0, Xsara 1.8 Vts 1998>0, Xsara 1.9 D 1993>0, Xsara 1.9 Sd 1998>0, Xsara 1.9 Td 1992>0, Xsara 2.0 16V 1997>0, Xsara 2.0 Hdi 109 2001>0, Xsara 2.0 Hdi 90 1999>0, Xsara Box Body / Hatchback 1.4 1998>0, Xsara Box Body / Hatchback 1.4 Lpg 1998>0, Xsara Box Body / Hatchback 1.8 D 1997>0, Xsara Box Body / Hatchback 1.9 D 1993>0, Xsara Box Body / Hatchback 2.0 Hdi 1999>0, Xsara Box Body/Estate 1.4 1998>0, Xsara Box Body/Estate 1.8 D 1997>0, Xsara Box Body/Estate 1.9 D 1993>0, Xsara Box Body/Estate 2.0 Hdi 1999>0, Xsara Break 1.4 Hdi 2003>0, Xsara Break 1.4 I 1997>0, Xsara Break 1.4 Lpg 1998>0, Xsara Break 1.5 D 1997>0, Xsara Break 1.6 16V 2000>0, Xsara Break 1.6 I 1997>0, Xsara Break 1.8 D 1997>0, Xsara Break 1.8 I 1992>0, Xsara Break 1.8 I 16V 1996>0, Xsara Break 1.8 I Aut. 1997>0, Xsara Break 1.8 Lpg 1998>0, Xsara Break 1.9 D 1993>0, Xsara Break 1.9 Td 1992>0, Xsara Break 2.0 16V 1997>0, Xsara Break 2.0 Hdi 109 2001>0, Xsara Break 2.0 Hdi 90 1999>0, Xsara Coupe 1.4 Hdi 2003>0, Xsara Coupe 1.4 I 1997>0, Xsara Coupe 1.6 16V 2000>0, Xsara Coupe 1.6 I 1997>0, Xsara Coupe 1.8 I 1992>0, Xsara Coupe 1.8 I 16V 1996>0, Xsara Coupe 1.8 Lpg 1998>0, Xsara Coupe 1.9 D 1993>0, Xsara Coupe 1.9 Td 1992>0, Xsara Coupe 2.0 16V 1997>0, Xsara Coupe 2.0 Hdi 109 2001>0, Xsara Coupe 2.0 Hdi 90 1999>0, Xsara Coupe 2.0 I 16V 1992>0, Xsara Picasso 1.6 1999>0, Xsara Picasso 1.8 16V 1997>0, Xsara Picasso 2.0 16V 1997>0, Xsara Picasso 2.0 Hdi 1999>0, Xz 1.8 1991>0, Xz 1.8 I 1992>0, Xz 1.8 I 16V 1996>0, Xz 1.9 1991>0, Xz 1.9 I 1991>0, Xz 1.9 Td 1992>0, Xz 2.0 1994>0, Xz 2.0 I 1992>0, Xz 2.0 I 16V 1992>0 PEUGEOT: 306 1.8 1991>0, 306 1.8 16V 1997>0, 306 1.8 St 1994>0, 306 1.9 D 1993>0, 306 2.0 1994>0, 306 2.0 Hdi 90 1999>0, 306 2.0 S16 1993>0, 306 2.0 St 1994>0, 306 Box Body/Estate 1.9 D 1993>0, 306 Convertible 1.8 1991>0, 306 Convertible 1.8 16V 1997>0, 306 Convertible 2.0 1994>0, 306 Convertible 2.0 16V 1997>0, 306 Hatchback 1.8 1991>0, 306 Hatchback 1.8 16V 1997>0, 306 Hatchback 1.9 D 1993>0, 306 Hatchback 1.9 Dt 1993>0, 306 Hatchback 2.0 16V 1997>0, 306 Hatchback 2.0 Hdi 90 1999>0, 306 Hatchback 2.0 S16 1993>0, 306 Hatchback 2.0 Xsi 1993>0



GS2286

REAR WHEEL SENSOR (RIGHT SIDE)

REPLACES / REEMPLAZA:

Bosch: 0 265 008 968

Fiat: 51918286

APPLICATION / APLICACIÓN:

Fiat: Fiorino 1.4, Strada 1.6/1.8



GS2287 // NEW //

FRONT WHEEL SENSOR (BOTH SIDES)

REPLACES / REEMPLAZA:

Citroën: 4545G6, 4545A9, 9642687580, 0986594520; Bosch: 986 594 520; Bremi: 50263; Delphi: SS20045; Meat & Doria: 90083; Mobiletron: AB-EU009

APPLICATION / APLICACIÓN:

CITROËN: C6 2.2 Hdi 2005>2012, C6 2.7 Hdi 2005>2012, C6 3.0 V6 2005>2012, C6 3.0 Hdi 2005>2012, PEUGEOT: 407 1.6 Hdi 110 2004>2011, 407 1.8 2004>2011, 407 1.8 16V 2004>2011, 407 2.0 2004>2011, 407 2.0 16V 2004>2011, 407 2.0 Flex 2004>2011, 407 2.0 Hdi 2004>2011, 407 2.0 Hdi 135 2004>2011, 407 2.2 2004>2011, 407 2.2 16V 2004>2011, 407 2.2 Hdi 2004>2011, 407 2.2 Hdi 170 2004>2011, 407 2.7 Hdi 2004>2011, 407 3.0 2004>2011, 407 3.0 V6 2004>2011, 407 Coupe 2.0 Hdi 2005>2010, 407 Coupe 2.2 16V 2005>2010, 407 Coupe 2.7 Hdi 2005>2010, 407 Coupe 3.0 Hdi 2005>2010, 407 Coupe 3.0 V6 2005>2010, 407 SW 1.6 Hdi 110 2004>2011, 407 SW 1.8 2004>2011, 407 SW 1.8 16V 2004>2011, 407 SW 2.0 2004>2011, 407 SW 2.0 16V 2004>2011, 407 SW 2.0 Flex 2004>2011, 407 SW 2.0 Hdi 2004>2011, 407 SW 2.0 Hdi 135 2004>2011, 407 SW 2.2 2004>2011, 407 SW 2.2 16V 2004>2011, 407 SW 2.2 Hdi 2004>2011, 407 SW 2.2 Hdi 170 2004>2011, 407 SW 2.7 Hdi 2004>2011, 407 SW 3.0 2004>2011, 407 SW 3.0 V6 2004>2011, 407 SW Box Body/Estate 1.6 Hdi 2004>2010

GS2288
REAR WHEEL SENSOR (LEFT SIDE)
REPLACES / REEMPLAZA:
Bosch: 0 265 008 969

Fiat: 51918288

APPLICATION / APLICACIÓN:
Fiat: Strada 1.4 CD

GS2289 // NEW //
FRONT WHEEL SENSOR (RIGHT SIDE)
REPLACES / REEMPLAZA:
Honda: 57455S04801, 57455S04802; **A.B.S.:** 30834

APPLICATION / APLICACIÓN:
HONDA: Civic Vi Coupe 1.6 1996>0, Civic Vi Coupe 1.6 I 1996>0, Civic Vi Coupe 1.6 I Vtec 1995>0, Civic Vi Coupe 1.6 I Vtec 1996>0, Civic Vi Fastback 1.4 I 1995>0, Civic Vi Fastback 1.5 16V 1997>0, Civic Vi Fastback 1.6 Vti 1997>0, Civic Vi Hatchback 1.4 I 1995>0, Civic Vi Hatchback 1.4 I S 1995>0, Civic Vi Hatchback 1.5 I 1995>0, Civic Vi Hatchback 1.6 I 1995>0, Civic Vi Hatchback 1.6 Vti 1995>0, Civic Vi Saloon 1.4 1995>0, Civic Vi Saloon 1.4 I 1995>0, Civic Vi Saloon 1.5 I 1995>0, Civic Vi Saloon 1.6 I Vtec 1995>0, Civic Vi Saloon 1.6 Vti 1995>0

GS2293
FRONT WHEEL SENSOR (LEFT SIDE)
REPLACES / REEMPLAZA:
Mazda: ALS2019, GS3L4370X, SU13681

APPLICATION / APLICACIÓN:
Mazda: 6 2009>2012

PS: set of GS2263

GS2294 // NEW //
REAR WHEEL SENSOR (BOTH SIDES)
REPLACES / REEMPLAZA:
Hyundai: 9568038100, 9568038600, 9568038000; **Delphi:** SS20244; **Meat & Doria:** 90305; **Mobiletron:** AB-KR005

APPLICATION / APLICACIÓN:
HYUNDAI: Grandeur 2.2 Crdi 2006>0, Sonata Iv 2.0 16V 1998>0, Sonata Iv 2.0 Crdi Dynamic 2001>0, Sonata Iv 2.4 16V 1998>0, Sonata Iv 2.5 V6 24V 1998>0, Sonata Iv 2.7 V6 2001>0, Xg 250 1998>0, Xg 3.0 2001>0, Xg 30 1998>0; **KIA:** Magentis 2.0 2001>0, Magentis 2.5 V6 2001>0, Magentis 2.7 V6 2001>0, Magentis 2.7 2005>0

GS2295 // NEW //
FRONT WHEEL SENSOR (LEFT SIDE)
REPLACES / REEMPLAZA:
Hyundai: 9567038000, 956703C000; **A.B.S.:** 30875;

Delphi: SS20189

APPLICATION / APLICACIÓN:
HYUNDAI: Sonata Iv 2.0 16V 1998>0, Sonata Iv 2.4 16V 1998>0, Sonata Iv 2.5 V6 24V 1998>0, Sonata Iv 2.7 V6 2001>0, Xg 250 1998>0, Xg 3.0 2001>0, Xg 30 1998>0, Xg 350 2002>0, Xg Saloon 250 1998>0, Xg Saloon 300 2000>0;

KIA: Magentis 2.0 2001>0, Magentis 2.5 V6 2001>0, Magentis 2.7 V6 2001>0, Magentis 2.7 2005>0

GS2296 // NEW //
FRONT WHEEL SENSOR (RIGHT SIDE)
REPLACES / REEMPLAZA:
Hyundai: 9567038100/ 956703C100; **A.B.S.:** 30876;

Delphi: SS20182; **Meat & Doria:** 90303; **Mobiletron:** AB-KR003

APPLICATION / APLICACIÓN:
HYUNDAI: Sonata Iv 2.0 16V 1998>0, Sonata Iv 2.4 16V 1998>0, Sonata Iv 2.5 V6 24V 1998>0, Sonata Iv 2.7 V6 2001>0, Xg 250 1998>0, Xg 3.0 2001>0, Xg 30 1998>0, Xg 350 2002>0, Xg Saloon 250 1998>0, Xg Saloon 300 2000>0;

KIA: Magentis 2.0 2001>0, Magentis 2.5 V6 2001>0, Magentis 2.7 2005>0, Magentis 2.7 V6 2001>0

GS2297 // NEW //
FRONT WHEEL SENSOR (RIGHT SIDE)
REPLACES / REEMPLAZA:
Kia: 956702E310, 956701F310; **A.B.S.:** 30922;

Delphi: SS20511; **Meat & Doria:** 90365

APPLICATION / APLICACIÓN:
KIA: Sportage 2.0 2009>0, Sportage 2.0 16V 4Wd 2004>0, Sportage 2.0 4Wd 2005>0, Sportage 2.0 Crdi 2005>0, Sportage 2.0 Crdi 4Wd 2004>0, Sportage 2.0 I 16V 2004>0, Sportage 2.0 Lpg 2009>0, Sportage 2.7 2005>0, Sportage 2.7 V6 4Wd 2004>0

GS2298 // NEW //
FRONT WHEEL SENSOR (LEFT SIDE)
REPLACES / REEMPLAZA:
Kia: 956702E300, 956701F300; **A.B.S.:** 30794;

Delphi: SS20504; **Meat & Doria:** 90226;

Mobiletron: AB-KR036

APPLICATION / APLICACIÓN:
HYUNDAI: Tucson 2.0 2004>0, Tucson 2.0 All-Wheel Drive 2004>0, Tucson 2.0 Crdi 2004>0, Tucson 2.0 Crdi All-Wheel Drive 2004>0, Tucson 2.0 Lpg 2004>0, Tucson 2.0 Lpg All-Wheel Drive 2009>0, Tucson 2.4 2009>0, Tucson 2.7 2004>0, Tucson 2.7 All-Wheel Drive 2004>0

GS2299 // NEW //
REAR WHEEL SENSOR (LEFT SIDE)
REPLACES / REEMPLAZA:
Kia: 956802 E 300; **A.B.S.:** 30895; **Delphi:** SS20521;

Meat & Doria: 90404

APPLICATION / APLICACIÓN:
HYUNDAI: Tucson 2.0 2004>0, Tucson 2.0 Crdi 2004>0, Tucson 2.4 2009>0, Tucson 2.7 2004>0;

KIA: Sportage 2.0 2004>0, Sportage 2.0 Crdi 2004>0, Sportage 2.0 I 16V 2004>0, Sportage 2.0 Lpg 2009>0, Sportage 2.7 2004>0

GS2300 // NEW //
REAR WHEEL SENSOR (RIGHT SIDE)
REPLACES / REEMPLAZA:
Kia: 956802E310; **A.B.S.:** 30896; **Delphi:** SS20520;

Meat & Doria: 90405

APPLICATION / APLICACIÓN:
HYUNDAI: Tucson 2.0 2004>0, Tucson 2.0 Crdi 2004>0, Tucson 2.4 2009>0, Tucson 2.7 2004>0;

KIA: Sportage 2.0 2004>0, Sportage 2.0 Crdi 2004>0, Sportage 2.0 I 16V 2004>0, Sportage 2.0 Lpg 2009>0, Sportage 2.7 2004>0

GS2301 // NEW //
REAR WHEEL SENSOR (LEFT SIDE)

REPLACES / REEMPLAZA:
Kia: 956802E400; **A.B.S.:** 30796; **Delphi:** SS20509;

Meat & Doria: 90228

APPLICATION / APLICACIÓN:
HYUNDAI: Tucson 2.0 All-Wheel Drive 2004>0, Tucson 2.0 Crdi 2004>0, Tucson 2.0 Crdi All-Wheel Drive 2004>0, Tucson 2.0 Lpg 2004>0, Tucson 2.0 Lpg All-Wheel Drive 2009>0, Tucson 2.7 All-Wheel Drive 2004>0 **KIA:** Sportage 2.0 16V 4Wd 2004>0, Sportage 2.0 4Wd 2005>0, Sportage 2.0 Crdi 4Wd 2004>0, Sportage 2.7 V6 4Wd 2004>0

GS2302 // NEW //
REAR WHEEL SENSOR (RIGHT SIDE)

REPLACES / REEMPLAZA:
Kia: 956802E500; **A.B.S.:** 30797; **Delphi:** SS20510;

Meat & Doria: 90229

APPLICATION / APLICACIÓN:
HYUNDAI: Tucson 2.0 All-Wheel Drive 2004>0, Tucson 2.0 Crdi 2004>0, Tucson 2.0 Crdi All-Wheel Drive 2004>0, Tucson 2.0 Lpg 2004>0, Tucson 2.0 Lpg All-Wheel Drive 2009>0, Tucson 2.7 All-Wheel Drive 2004>0;

KIA: Sportage 2.0 16V 4Wd 2004>0, Sportage 2.0 4Wd 2005>0, Sportage 2.0 Crdi 4Wd 2004>0, Sportage 2.7 V6 4Wd 2004>0

GS2303 // NEW //
FRONT WHEEL SENSOR (LEFT SIDE)

REPLACES / REEMPLAZA:
Hyundai: 598103K000; **A.B.S.:** 31444;

Meat & Doria: 90489

APPLICATION / APLICACIÓN:
HYUNDAI: Grandeur 2.2 Crdi 2006>0, Grandeur 3.3 2005>0, Sonata V 2.0 Crdi 2006>0, Sonata V 2.0 Vvti Glis 2005>0, Sonata V 2.4 2005>0, Sonata V 3.3 2005>0

GS2304 // NEW //
FRONT WHEEL SENSOR (RIGHT SIDE)

REPLACES / REEMPLAZA:
Hyundai: 598303K000; **A.B.S.:** 31445;

Meat & Doria: 90490

APPLICATION / APLICACIÓN:
HYUNDAI: Grandeur 2.2 Crdi 2006>0, Grandeur 3.3 2005>0, Sonata V 2.0 Crdi 2006>0, Sonata V 2.0 Vvti Glis 2005>0, Sonata V 2.4 2005>0, Sonata V 3.3 2005>0

GS2305 // NEW //
REAR WHEEL SENSOR (LEFT SIDE)

REPLACES / REEMPLAZA:
Hyundai: 599103K000; **A.B.S.:** 30880

APPLICATION / APLICACIÓN:
HYUNDAI: Grandeur 2.2 Crdi 2006>0, Grandeur 2.7 2006>0, Grandeur 3.3 2005>0, Sonata V 2.0 Crdi 2006>0, Sonata V 2.0 Vvti Glis 2005>0, Sonata V 2.4 2005>0, Sonata V 3.3 2005>0

GS2306 // NEW //
REAR WHEEL SENSOR (RIGHT SIDE)

REPLACES / REEMPLAZA:
Hyundai: 599303K000; **A.B.S.:** 31539

APPLICATION / APLICACIÓN:
HYUNDAI: Grandeur 2.2 Crdi 2006>0, Grandeur 2.7 2006>0, Grandeur 3.3 2005>0, Sonata V 2.0 Crdi 2006>0, Sonata V 2.0 Vvti Glis 2005>0, Sonata V 2.4 2005>0, Sonata V 3.3 2005>0

GS2307 // NEW //
FRONT WHEEL SENSOR (LEFT SIDE)

REPLACES / REEMPLAZA:
Hyundai: 9561026000, 9561026010; **A.B.S.:** 30883;

Delphi: SS20507; **Meat & Doria:** 90360

APPLICATION / APLICACIÓN:
HYUNDAI: Santa Fé I 2.0 2001>0, Santa Fé I 2.0 Crdi 2001>0, Santa Fé I 2.0 Crdi 4X4 2001>0, Santa Fé I 2.0 Crdi All-Wheel Drive 2003>0, Santa Fé I 2.4 2001>0, Santa Fé I 2.4 16V 2001>0, Santa Fé I 2.4 16V 4X4 2001>0, Santa Fé I 2.4 4X4 2000>0, Santa Fé I 2.7 2000>0, Santa Fé I 2.7 4X4 2000>0, Santa Fé I 2.7 V6 4X4 2001>0, Santa Fé I 3.5 2002>0, Santa Fé I 3.5 4X4 2002>0

GS2308 // NEW //
FRONT WHEEL SENSOR (RIGHT SIDE)

REPLACES / REEMPLAZA:
Hyundai: 9562026000, 9562026010; **A.B.S.:** 30884;

Delphi: SS20508; **Meat & Doria:** 90361

APPLICATION / APLICACIÓN:
HYUNDAI: Santa Fé I 2.0 2001>0, Santa Fé I 2.0 Crdi 2001>0, Santa Fé I 2.0 Crdi 4X4 2001>0, Santa Fé I 2.0 Crdi All-Wheel Drive 2003>0, Santa Fé I 2.4 2001>0, Santa Fé I 2.4 16V 2001>0, Santa Fé I 2.4 16V 4X4 2001>0, Santa Fé I 2.4 4X4 2000>0, Santa Fé I 2.7 2000>0, Santa Fé I 2.7 4X4 2000>0, Santa Fé I 2.7 V6 4X4 2001>0, Santa Fé I 3.5 2002>0, Santa Fé I 3.5 4X4 2002>0

GS2309 // NEW //
REAR WHEEL SENSOR (LEFT SIDE)

REPLACES / REEMPLAZA:
Hyundai: 9563026000; **A.B.S.:** 30885; **Delphi:** SS20538;

Meat & Doria: 90362

APPLICATION / APLICACIÓN:
HYUNDAI: Santa Fé I 2.0 2001>0, Santa Fé I 2.0 Crdi 2001>0, Santa Fé I 2.4 2001>0, Santa Fé I 2.4 16V 2001>0, Santa Fé I 2.7 2000>0

GS2310 // NEW //
REAR WHEEL SENSOR (RIGHT SIDE)

REPLACES / REEMPLAZA:
Hyundai: 9564026000; **A.B.S.:** 30886; **Delphi:** SS20506;

Meat & Doria: 90363

APPLICATION / APLICACIÓN:
HYUNDAI: Santa Fé I 2.0 2001>0, Santa Fé I 2.0 Crdi 2001>0, Santa Fé I 2.4 2001>0, Santa Fé I 2.4 16V 2001>0, Santa Fé I 2.7 2000>0

GS2311 // NEW //
FRONT WHEEL SENSOR (LEFT SIDE)
REPLACES / REEMPLAZA:
Kia: 956802D000, 956802D050; **A.B.S.:** 30867;

Delphi: SS20221; **Meat & Doria:** 90308

APPLICATION / APLICACIÓN:
HYUNDAI: Elantra 1.6 2000>0, Elantra 1.8 2000>0, Elantra 2.0 2000>0, Elantra 2.0 Crdi 2001>0, Elantra Saloon 1.6 2000>0, Elantra Saloon 1.8 2000>0, Elantra Saloon 2.0 2000>0, Elantra Saloon 2.0 Crdi 2001>0, Matrix 1.6 2000>0;

KIA: Cerato Hatchback 1.5 Crdi 2005>0, Cerato Hatchback 1.6 2000>0, Cerato Hatchback 1.6 Crdi 2005>0, Cerato Hatchback 1.8 2000>0, Cerato Hatchback 2.0 2000>0, Cerato Hatchback 2.0 Crdi 2001>0, Cerato Saloon 1.5 Crdi 2005>0, Cerato Saloon 1.6 2000>0, Cerato Saloon 1.6 Crdi 2005>0, Cerato Saloon 2.0 2000>0, Cerato Saloon 2.0 Crdi 2001>0

GS2312 // NEW //
REAR WHEEL SENSOR (RIGHT SIDE)
REPLACES / REEMPLAZA:
Kia: 956802D100, 956802D150; **A.B.S.:** 30868;

Delphi: SS20245; **Meat & Doria:** 90309

APPLICATION / APLICACIÓN:
HYUNDAI: Elantra 1.6 2000>0, Elantra 1.8 2000>0, Elantra 2.0 2000>0, Elantra 2.0 Crdi 2001>0, Elantra Saloon 1.6 2000>0, Elantra Saloon 1.8 2000>0, Elantra Saloon 2.0 2000>0, Elantra Saloon 2.0 Crdi 2001>0, Matrix 1.6 2000>0;

KIA: Cerato Hatchback 1.5 Crdi 2005>0, Cerato Hatchback 1.6 2000>0, Cerato Hatchback 1.6 Crdi 2005>0, Cerato Hatchback 1.8 2000>0, Cerato Hatchback 2.0 2000>0, Cerato Hatchback 2.0 Crdi 2001>0, Cerato Saloon 1.5 Crdi 2005>0, Cerato Saloon 1.6 2000>0, Cerato Saloon 1.6 Crdi 2005>0, Cerato Saloon 2.0 2000>0, Cerato Saloon 2.0 Crdi 2001>0

GS2313
FRONT WHEEL SENSOR
REPLACES / REEMPLAZA:
Opel: 96626078, 19256115, 4809313

Chevrolet: 96626078, 19256115, 4809313

APPLICATION / APLICACIÓN:
Chevrolet: Captiva 2.0/2.4/3.2

Opel: Antara 2.0/2.4/3.2

PS: set of GS2080

GS2314 // NEW //
FRONT WHEEL SENSOR (LEFT SIDE)
REPLACES / REEMPLAZA:
Kia: 956702S300, 956703W300; **A.B.S.:** 31062;

Meat & Doria: 90374

APPLICATION / APLICACIÓN:
HYUNDAI: Ix35 1.6 2010>0, Ix35 1.7 Crdi 2010>0, Ix35 2.0 2010>0, Ix35 2.0 4Wd 2010>0, Ix35 2.0 Crdi 2010>0, Ix35 2.0 Crdi 4Wd 2010>0

GS2315 // NEW //
FRONT WHEEL SENSOR (RIGHT SIDE)
REPLACES / REEMPLAZA:
Kia: 956712S300, 956713W300; **A.B.S.:** 31068;

Meat & Doria: 90407

APPLICATION / APLICACIÓN:
KIA: Sportage 1.6 Gdi 2011>0, Sportage 1.7 Crdi 2010>0, Sportage 2.0 Crdi 2010>0, Sportage 2.0 Crdi Awd 2010>0, Sportage 2.0 Cvvt 2010>0, Sportage 2.0 Cvvt Awd 2010>0, Sportage 2.0 Gdi 2014>0

GS2316 // NEW //
REAR WHEEL SENSOR (LEFT SIDE)
REPLACES / REEMPLAZA:
Kia: 956802S500; **A.B.S.:** 31083; **Meat & Doria:** 90831, 90831E

APPLICATION / APLICACIÓN:
HYUNDAI: Ix35 2.0 2010>0, Ix35 2.0 4Wd 2010>0, Ix35 2.0 Crdi 2010>0, Ix35 2.0 Crdi 4Wd 2010>0, Ix35 2.0 Gdi 2013>0, Ix35 2.0 Gdi 4Wd 2013>0;

KIA: Sportage 2.0 Crdi 2010>0, Sportage 2.0 Crdi Awd 2010>0, Sportage 2.0 Cvvt 2010>0, Sportage 2.0 Cvvt Awd 2010>0, Sportage 2.0 Gdi 2013>0, Sportage 2.0 Gdi Awd 2014>0

GS2317 // NEW //
REAR WHEEL SENSOR (LEFT SIDE)
REPLACES / REEMPLAZA:
Kia: 956802S300; **A.B.S.:** 31064; **Meat & Doria:** 90376

APPLICATION / APLICACIÓN:
HYUNDAI: Ix35 1.6 2010>0, Ix35 1.7 Crdi 2010>0, Ix35 2.0 2010>0, Ix35 2.0 4Wd 2010>0, Ix35 2.0 Crdi 2010>0, Ix35 2.0 Crdi 4Wd 2010>0;

KIA: Sportage 1.6 Gdi 2011>0, Sportage 1.7 Crdi 2010>0, Sportage 2.0 Crdi 2010>0, Sportage 2.0 Cvvt 2010>0, Sportage 2.0 Gdi 2014>0

GS2329 // NEW //
FRONT WHEEL SENSOR (RIGHT SIDE)
REPLACES / REEMPLAZA:
Hyundai: 956713J000; **A.B.S.:** 31555;

Meat & Doria: 90836, 90836E

APPLICATION / APLICACIÓN:
HYUNDAI: Ix55 3.0 V6 Crdi 4Wd 2008>0, Ix55 3.8 V6 2011>0, Ix55 3.8 V6 4Wd 2011>0;

KIA: Sorento li 2.0 Crdi 2009>0, Sorento li 2.0 Crdi 4Wd 2010>0, Sorento li 2.2 Crdi 2009>0, Sorento li 2.2 Crdi 4Wd 2009>0, Sorento li 2.4 Cvvt 2009>0, Sorento li 2.4 Cvvt 4Wd 2009>0, Sorento li 2.4 Gdi 2012>0, Sorento li 2.4 Gdi 4Wd 2012>0

GS2330 // NEW //
FRONT WHEEL SENSOR (LEFT SIDE)
REPLACES / REEMPLAZA:
Hyundai: 956703J000; **A.B.S.:** 31554;

Meat & Doria: 90835, 90835E

APPLICATION / APLICACIÓN:
HYUNDAI: Ix55 3.0 V6 Crdi 4Wd 2008>0, Ix55 3.8 V6 2011>0, Ix55 3.8 V6 4Wd 2011>0;

KIA: Sorento li 2.0 Crdi 2009>0, Sorento li 2.0 Crdi 4Wd 2010>0, Sorento li 2.2 Crdi 2009>0, Sorento li 2.2 Crdi 4Wd 2009>0, Sorento li 2.4 Cvvt 2009>0, Sorento li 2.4 Cvvt 4Wd 2009>0, Sorento li 2.4 Gdi 2012>0, Sorento li 2.4 Gdi 4Wd 2012>0

GS2333 // NEW //
FRONT WHEEL SENSOR (RIGHT SIDE)
REPLACES / REEMPLAZA:
Hyundai: 956712B000, 956702B210; **A.B.S.:** 31061;

Meat & Doria: 90937

APPLICATION / APLICACIÓN:
HYUNDAI: Santa Fé li 2.0 Crdi 4X4 2006>0, Santa Fé li 2.2 Crdi 2006>0, Santa Fé li 2.2 Crdi 4X4 2006>0, Santa Fé li 2.2 Crdi Gls 2006>0, Santa Fé li 2.2 Crdi Gls 4X4 2006>0, Santa Fé li 2.7 2006>0, Santa Fé li 2.7 4X4 2006>0, Santa Fé li 2.7 V6 Gls 2006>0, Santa Fé li 2.7 V6 Gls 4X4 2006>0

GS2335 // NEW //
REAR WHEEL SENSOR (LEFT SIDE)
REPLACES / REEMPLAZA:
Hyundai: 956802B000; **A.B.S.:** 30887;

Meat & Doria: 90499

APPLICATION / APLICACIÓN:
HYUNDAI: Santa Fé li 2.0 Crdi 2010>0, Santa Fé li 2.0 Crdi 4X4 2010>0, Santa Fé li 2.2 Crdi 2006>0, Santa Fé li 2.2 Crdi 4X4 2006>0, Santa Fé li 2.2 Crdi Gls 2006>0, Santa Fé li 2.2 Crdi Gls 4X4 2006>0, Santa Fé li 2.4 2010>0, Santa Fé li 2.4 4X4 2010>0, Santa Fé li 2.7 V6 Gls 2006>0, Santa Fé li 2.7 V6 Gls 4X4 2006>0

GS2336 // NEW //
FRONT WHEEL SENSOR (RIGHT SIDE)
REPLACES / REEMPLAZA:
Kia: 956712W000; **A.B.S.:** 31670; **Meat & Doria:** 90848, 90848E

APPLICATION / APLICACIÓN:
HYUNDAI: Grand Santa Fé 2.2 Crdi All-Wheel Drive 2013>0, Grand Santa Fé 3.3 2014>0, Grand Santa Fé 3.3 All-Wheel Drive 2014>0, Santa Fé li 2.0 Crdi 2009>0, Santa Fé li 2.0 Crdi 4Wd 2010>0, Santa Fé li 2.2 Crdi 2009>0, Santa Fé li 2.2 Crdi 4Wd 2009>0, Santa Fé li 2.4 2012>0, Santa Fé li 2.4 4Wd 2012>0, Santa Fé li 2.4 Ccvt 2012>0, Santa Fé li 2.4 Ccvt Awd 2012>0, Santa Fé li 2.4 Gdi 2012>0, Santa Fé li 2.4 Gdi 4Wd 2012>0;

KIA: Sorento li 2.0 Crdi 2009>0, Sorento li 2.0 Crdi 4Wd 2010>0, Sorento li 2.2 Crdi 2009>0, Sorento li 2.2 Crdi 4Wd 2009>0, Sorento li 2.4 Ccvt 2012>0, Sorento li 2.4 Ccvt 4Wd 2012>0, Sorento li 2.4 Gdi 2012>0, Sorento li 2.4 Gdi 4Wd 2012>0, Sorento li 3.5 2013>0, Sorento li 3.5 4Wd 2013>0

GS2337 // NEW //
FRONT WHEEL SENSOR (LEFT SIDE)
REPLACES / REEMPLAZA:
Kia: 956702W000; **A.B.S.:** 31669; **Meat & Doria:** 90847, 90847E

APPLICATION / APLICACIÓN:
HYUNDAI: Grand Santa Fé 2.2 Crdi All-Wheel Drive 2013>0, Grand Santa Fé 3.3 2014>0, Grand Santa Fé 3.3 All-Wheel Drive 2014>0, Santa Fé li 2.0 Crdi 2009>0, Santa Fé li 2.0 Crdi 4Wd 2010>0, Santa Fé li 2.2 Crdi 2009>0, Santa Fé li 2.2 Crdi 4Wd 2009>0, Santa Fé li 2.4 2012>0, Santa Fé li 2.4 4Wd 2012>0, Santa Fé li 2.4 Ccvt 2012>0, Santa Fé li 2.4 Ccvt Awd 2012>0, Santa Fé li 2.4 Gdi 2012>0, Santa Fé li 2.4 Gdi 4Wd 2012>0;

KIA: Sorento li 2.0 Crdi 2009>0, Sorento li 2.0 Crdi 4Wd 2010>0, Sorento li 2.2 Crdi 2009>0, Sorento li 2.2 Crdi 4Wd 2009>0, Sorento li 2.4 Ccvt 2012>0, Sorento li 2.4 Ccvt 4Wd 2012>0, Sorento li 2.4 Gdi 2012>0, Sorento li 2.4 Gdi 4Wd 2012>0, Sorento li 3.5 2013>0, Sorento li 3.5 4Wd 2013>0

GS2338 // NEW //
REAR WHEEL SENSOR (BOTH SIDES)
REPLACES / REEMPLAZA:
Kia: 956812W000, 956802W000; **Meat & Doria:** 90849, 90849E

APPLICATION / APLICACIÓN:
HYUNDAI: Grand Santa Fé 2.2 Crdi All-Wheel Drive 2013>0, Grand Santa Fé 3.3 2014>0, Grand Santa Fé 3.3 All-Wheel Drive 2014>0, Santa Fé li 2.0 Crdi 2009>0, Santa Fé li 2.0 Crdi 4Wd 2010>0, Santa Fé li 2.2 Crdi 2009>0, Santa Fé li 2.2 Crdi 4Wd 2009>0, Santa Fé li 2.4 2012>0, Santa Fé li 2.4 4Wd 2012>0, Santa Fé li 2.4 Ccvt 2012>0, Santa Fé li 2.4 Ccvt Awd 2012>0, Santa Fé li 2.4 Gdi 2012>0, Santa Fé li 2.4 Gdi 4Wd 2012>0;

KIA: Sorento li 2.0 Crdi 2009>0, Sorento li 2.0 Crdi 4Wd 2010>0, Sorento li 2.2 Crdi 2009>0, Sorento li 2.2 Crdi 4Wd 2009>0, Sorento li 2.4 Ccvt 2012>0, Sorento li 2.4 Ccvt 4Wd 2012>0, Sorento li 2.4 Gdi 2012>0, Sorento li 2.4 Gdi 4Wd 2012>0, Sorento li 3.5 2013>0, Sorento li 3.5 4Wd 2013>0

GS2350 // NEW //
FRONT WHEEL SENSOR (BOTH SIDES)
REPLACES / REEMPLAZA:
Jac: 3630200U8010, 3630100U8010

APPLICATION / APLICACIÓN:
JAC: J3 2010>2015

GS2351 // NEW //
REAR WHEEL SENSOR (RIGHT SIDE)
REPLACES / REEMPLAZA:
Jac: 3630400U8010

APPLICATION / APLICACIÓN:
JAC: J3 2010>2015

GS2352 // NEW //
REAR WHEEL SENSOR (LEFT SIDE)
REPLACES / REEMPLAZA:
Jac: 3630300U8010

APPLICATION / APLICACIÓN:
JAC: J3 2010>2015

GS2353 // NEW //
FRONT WHEEL SENSOR (BOTH SIDES)
REPLACES / REEMPLAZA:
Jac: 3630040U2010, 3630010U2010

APPLICATION / APLICACIÓN:
JAC: J5 2011>2016, J6 2011>2016

GS2354 // NEW //
REAR WHEEL SENSOR (RIGHT SIDE)
REPLACES / REEMPLAZA:
Jac: 3630060U2010

APPLICATION / APLICACIÓN:
JAC: J5 2011>2016, J6 2011>2016

GS2358 // NEW //
FRONT WHEEL SENSOR (RIGHT SIDE)
REPLACES / REEMPLAZA:
Kia: 956713 E 010; **A.B.S.:** 30918; **Meat & Doria:** 90469

APPLICATION / APLICACIÓN:
KIA: Sorento I 2.4 2002>0, Sorento I 2.5 Crdi 2002>0, Sorento I 3.5 V6 4Wd 2002>0

GS2359 // NEW //
FRONT WHEEL SENSOR (LEFT SIDE)
REPLACES / REEMPLAZA:
Kia: 956713 E 200; **A.B.S.:** 30917; **Delphi:** SS20642;

Meat & Doria: 90468

APPLICATION / APLICACIÓN:
KIA: Sorento I 2.4 2002>0, Sorento I 2.5 Crdi 2002>0, Sorento I 2.5 Crdi 4Wd 2006>0, Sorento I 3.5 2002>0, Sorento I 3.5 V6 4Wd 2002>0

GS2362 // NEW //
FRONT WHEEL SENSOR (LEFT SIDE)
REPLACES / REEMPLAZA:
Mercedes Benz: 1685400017, A1685400017, 0265006370,

0265006369; Bosch: 0 265 006 370; **Delphi:** SS20292;

Meat & Doria: 90275; **Mobiletron:** AB-EU149

APPLICATION / APLICACIÓN:
MERCEDES-BENZ: A-Class A 140 (168.031, 168.131) 1997>2004, A-Class A 160 (168.033, 168.133) 1997>2004, A-Class A 160 CDI (168.006) 1997>2004, A-Class A 160 CDI (168.007) 1997>2004, A-Class A 170 CDI (168.008) 1997>2004, A-Class A 170 CDI (168.009, 168.109) 1997>2004, A-Class A 190 (168.032, 168.132) 1997>2004, A-Class A 210 (168.035, 168.135) 1997>2004, Vaneo 1.6 (414.700) 2002>2005, Vaneo 1.7 CDI (414.700) 2002>2005, Vaneo 1.9 (414.700) 2002>2005, A-Class A 190 Twin Engine 1997>2004

GS2363 // NEW //
FRONT WHEEL SENSOR (RIGHT SIDE)
REPLACES / REEMPLAZA:
Mercedes Benz: 1685400117, A1685400117, 0265006367,

0265006368; Bosch: 0 265 006 368; **Delphi:** SS20293;

Meat & Doria: 90276; **Mobiletron:** AB-EU215

APPLICATION / APLICACIÓN:
MERCEDES-BENZ: A-Class A 140 (168.031, 168.131) 1997>2004, A-Class A 160 (168.033, 168.133) 1997>2004, A-Class A 160 CDI (168.006) 1997>2004, A-Class A 160 CDI (168.007) 1997>2004, A-Class A 170 CDI (168.008) 1997>2004, A-Class A 170 CDI (168.009, 168.109) 1997>2004, A-Class A 190 (168.032, 168.132) 1997>2004, A-Class A 210 (168.035, 168.135) 1997>2004, Vaneo 1.6 (414.700) 2002>2005, Vaneo 1.7 CDI (414.700) 2002>2005, Vaneo 1.9 (414.700) 2002>2005, A-Class A 190 Twin Engine 1997>2004

GS2364 // NEW //
REAR WHEEL SENSOR (BOTH SIDES)
REPLACES / REEMPLAZA:
Mercedes Benz: 1685400317, A1685400317, 0265006371,

0265006372; Delphi: SS20137; **Meat & Doria:** 90277;

Mobiletron: AB-EU151

APPLICATION / APLICACIÓN:
MERCEDES-BENZ: A-Class A 140 (168.031, 168.131) 1997>2004, A-Class A 160 (168.033, 168.133) 1997>2004, A-Class A 160 CDI (168.006) 1997>2004, A-Class A 160 CDI (168.007) 1997>2004, A-Class A 170 CDI (168.008) 1997>2004, A-Class A 170 CDI (168.009, 168.109) 1997>2004, A-Class A 190 (168.032, 168.132) 1997>2004, A-Class A 190 Twin Engine 1997>2004, A-Class A 210 (168.035, 168.135) 1997>2004, Vaneo 1.6 (414.700) 2002>2005, Vaneo 1.7 CDI (414.700) 2002>2005, Vaneo 1.9 (414.700) 2002>2005

GS2365 // NEW //
FRONT WHEEL SENSOR (LEFT SIDE)
REPLACES / REEMPLAZA:
Kia: 598101M300; **Meat & Doria:** 90837, 90837E

APPLICATION / APLICACIÓN:
KIA: Cerato Ii Saloon 1.6 2010>0, Cerato Ii Saloon 1.6 Cvtv 2009>0, Cerato Ii Saloon 2.0 2009>0, Cerato Koup 1.6 Cvtv 2009>0, Cerato Koup 2.0 Cvtv 2009>0

GS2366 // NEW //
FRONT WHEEL SENSOR (LEFT SIDE)
REPLACES / REEMPLAZA:
Kia: 956713 E 300; **A.B.S.:** 31429; **Delphi:** SS20621;

Meat & Doria: 90352; **Mobiletron:** AB-KR035

APPLICATION / APLICACIÓN:
KIA: Sorento I 2.5 Crdi 2006>0, Sorento I 2.5 Crdi 4Wd 2006>0, Sorento I 3.3 V6 2006>0

GS2367 // NEW //
FRONT WHEEL SENSOR (RIGHT SIDE)
REPLACES / REEMPLAZA:
Kia: 956713E310; **A.B.S.:** 31434; **Meat & Doria:** 90353

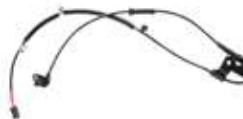
APPLICATION / APLICACIÓN:
KIA: Sorento I 2.4 2002>0, Sorento I 2.5 Crdi 2002>0, Sorento I 3.3 V6 2006>0, Sorento I 3.3 V6 4Wd 2007>0, Sorento I 3.5 V6 4Wd 2002>0

GS2370 // NEW //
FRONT WHEEL SENSOR (RIGHT SIDE)
REPLACES / REEMPLAZA:
Kia: 956712P000; **A.B.S.:** 31550; **Meat & Doria:** 90383

APPLICATION / APLICACIÓN:
KIA: Sorento Ii 2.2 Crdi 2009>0, Sorento Ii 2.2 Crdi 4Wd 2009>0, Sorento Ii 2.4 Cvtv 2009>0, Sorento Ii 2.4 Cvtv 4Wd 2009>0

GS2371 // NEW //
FRONT WHEEL SENSOR (LEFT SIDE)
REPLACES / REEMPLAZA:
Kia: 956702P000; **A.B.S.:** 31431; **Meat & Doria:** 90382

APPLICATION / APLICACIÓN:
KIA: Sorento Ii 2.2 Crdi 2009>0, Sorento Ii 2.2 Crdi 4Wd 2009>0, Sorento Ii 2.4 Cvtv 2009>0, Sorento Ii 2.4 Cvtv 4Wd 2009>0

GS2376 // NEW //
REAR WHEEL SENSOR (BOTH SIDES)
REPLACES / REEMPLAZA:
Land Rover: LR001057; **Delphi:** SS20373; **Meat &**
Doria: 90610; **Mobiletron:** AB-EU249

APPLICATION / APLICACIÓN:
LAND ROVER: Freelander 2 2.0 Si4 4x4 2006>2014, Freelander 2 2.2 eD4 2006>2014, Freelander 2 2.2 SD4 4x4 2006>2014, Freelander 2 2.2 TD4 4x4 2006>2014, Freelander 2 3.2 4x4 2006>2014, Freelander 2 VAN 2.2 TD4 4x4 2006>2014

GS2377 // NEW //
FRONT WHEEL SENSOR (BOTH SIDES)
REPLACES / REEMPLAZA:
Land Rover: LR001056, LR024202; **Delphi:** SS20372;

Meat & Doria: 90609; **Mobiletron:** AB-EU248

APPLICATION / APLICACIÓN:
LAND ROVER: Freelander 2 2.0 Si4 4x4 2006>2014, Freelander 2 2.2 eD4 2006>2014, Freelander 2 2.2 SD4 4x4 2006>2014, Freelander 2 2.2 TD4 4x4 2006>2014, Freelander 2 3.2 4x4 2006>2014, Freelander 2 VAN 2.2 TD4 4x4 2006>2014

GS2378 // NEW //
REAR WHEEL SENSOR (BOTH SIDES)
REPLACES / REEMPLAZA:
Land Rover: LR024203; **A.B.S.:** 31260; **Meat & Doria:**
90608; Mobiletron: AB-EU411

APPLICATION / APLICACIÓN:
LAND ROVER: Range Rover Evoque 2.0 4X4 2011>0, Range Rover Evoque 2.0 D 2015>0, Range Rover Evoque 2.0 D 4X4 2015>0, Range Rover Evoque 2.2 D 2011>0, Range Rover Evoque 2.2 D 4X4 2011>0

GS2379 // NEW //
FRONT WHEEL SENSOR (BOTH SIDES)
REPLACES / REEMPLAZA:
Land Rover: 0265008266, LR013783, AH229E731AB;
Bosch: 0 265 008 266; **Delphi:** SS20367; **Meat & Doria:** 90241; **Mobiletron:** AB-EU235

APPLICATION / APLICACIÓN:
LAND ROVER: Discovery Iv 2.7 Td 4X4 2009>0, Discovery Iv 3.0 4X4 2013>0, Discovery Iv 3.0 Sdv6 4X4 2009>0, Discovery Iv 3.0 Td 4X4 2009>0, Discovery Iv 4.0 4X4 2009>0, Discovery Iv 5.0 4X4 2009>0, Discovery Iv 5.0 V8 4X4 2009>0, Discovery Iv Van 3.0 Td 4X4 2009>0

GS2380 // NEW //
REAR WHEEL SENSOR (BOTH SIDES)
REPLACES / REEMPLAZA:
Land Rover: SSB500100, SSB500102, 0265007922, 0265007651; **Bosch:** 0 265 007 651, 0 265 007 922; **Delphi:** SS20166; **A.B.S.:** 30569; **Meat & Doria:** 90239; **Mobiletron:** AB-EU199

APPLICATION / APLICACIÓN:
LAND ROVER: Discovery Iii 2.7 Td 4X4 2004>2009, Discovery Iii 4.0 V6 4X4 2004>2009, Discovery Iii 4.4 4X4 2004>2009, Discovery Iv 2.7 Td 4X4 2009>, Discovery Iv 3.0 4X4 2013>, Discovery Iv 3.0 Sdv6 4X4 2009>, Discovery Iv 3.0 Td 4X4 2009>, Discovery Iv 5.0 V8 4X4 2009>, Range Rover Iii 3.6 D 4X4 2006>2012, Range Rover Iii 4.2 4X4 2005>2012, Range Rover Sport 2.7 D 4X4 2005>2013, Range Rover Sport 3.0 D 4X4 2009>2013, Range Rover Sport 3.6 D 4X4 2006>2013, Range Rover Sport 4.2 4X4 2005>2013, Range Rover Sport 4.4 4X4 2005>2013, Range Rover Sport 5.0 4X4 2009>2013, Range Rover Sport 3.0 Sdv6 4X4 2013>, Range Rover Sport 3.0 Sdv6 Hybrid 4X4 2013>, Range Rover Sport 3.0 Tdv6 4X4 2013>, Range Rover Sport 5.0 Scv8 4X4 2013>

GS2381 // NEW //
REAR WHEEL SENSOR (BOTH SIDES)
REPLACES / REEMPLAZA:
Land Rover: LR033457; **Bosch:** 0 265 009 326; **A.B.S.:** 31625

APPLICATION / APLICACIÓN:
LAND ROVER: Range Rover Iv 3.0 Scv6 4X4 2013>0, Range Rover Iv 3.0 Sdv6 4X4 2012>0, Range Rover Iv 3.0 Sdv6 Hybrid 4X4 2013>0, Range Rover Iv 3.0 Tdv6 4X4 2012>0, Range Rover Iv 4.4 Sdv8 4X4 2012>0, Range Rover Iv 5.0 Scv8 4X4 2012>0, Range Rover Iv 5.0 V8 4X4 2013>0, Range Rover Sport 2.0 Sd4 4X4 2016>0, Range Rover Sport 3.0 Scv6 4X4 2013>0, Range Rover Sport 3.0 Sdv6 4X4 2012>0, Range Rover Sport 3.0 Sdv6 Hybrid 4X4 2013>0, Range Rover Sport 3.0 Tdv6 4X4 2012>0, Range Rover Sport 4.4 Sdv8 4X4 2012>0, Range Rover Sport 5.0 Scv8 4X4 2012>0

GS2382 // NEW //
FRONT WHEEL SENSOR (BOTH SIDES)
REPLACES / REEMPLAZA:
Land Rover: LR033461; **Bosch:** 0 265 009 325; **A.B.S.:** 31626

APPLICATION / APLICACIÓN:
LANDROVER: Range Rover Iv 3.0 Scv6 4X4 2013>0, Range Rover Iv 3.0 Sdv6 4X4 2012>0, Range Rover Iv 3.0 Sdv6 Hybrid 4X4 2013>0, Range Rover Iv 3.0 Tdv6 4X4 2012>0, Range Rover Iv 4.4 Sdv8 4X4 2012>0, Range Rover Iv 5.0 Scv8 4X4 2012>0, Range Rover Iv 5.0 V8 4X4 2013>0, Range Rover Sport 2.0 Sd4 4X4 2016>0, Range Rover Sport 3.0 Scv6 4X4 2013>0, Range Rover Sport 3.0 Sdv6 4X4 2012>0, Range Rover Sport 3.0 Sdv6 Hybrid 4X4 2013>0, Range Rover Sport 3.0 Tdv6 4X4 2012>0, Range Rover Sport 4.4 Sdv8 4X4 2012>0, Range Rover Sport 5.0 Scv8 4X4 2012>0

GS2383
FRONT WHEEL SENSOR
REPLACES / REEMPLAZA:
Bosch: 0 265 006 383
Renault: 7700411747, 7700415681

APPLICATION / APLICACIÓN:
Renault: Clio Mk2 hatch/van, Thalia

GS2384 // NEW //
FRONT WHEEL SENSOR (BOTH SIDES)
REPLACES / REEMPLAZA:
Land Rover: SSB000011, SSF500011, SSF000011;
A.B.S.: 30761; **Meat & Doria:** 90977; **Mobiletron:** AB-EU196

APPLICATION / APLICACIÓN:
LANDROVER: Range Rover Iii 3.0 D 4X4 2002>0, Range Rover Iii 3.6 D 4X4 2006>0, Range Rover Iii 4.2 4X4 2005>0, Range Rover Iii 4.4 4X4 2002>0, Range Rover Iii 4.4 D 4X4 2010>0, Range Rover Iii 5.0 4X4 2009>0

GS2385 // NEW //
REAR WHEEL SENSOR (BOTH SIDES)
REPLACES / REEMPLAZA:
Land Rover: SSB500062, SSF000021; **A.B.S.:** 30762; **Meat & Doria:** 90978; **Mobiletron:** AB-EU324

APPLICATION / APLICACIÓN:
LAND ROVER: Range Rover Iii 3.0 D 4X4 2002>0, Range Rover Iii 4.2 4X4 2005>0, Range Rover Iii 4.4 4X4 2002>0

GS2388 // NEW //
REAR WHEEL SENSOR (BOTH SIDES)
REPLACES / REEMPLAZA:
Land Rover: SSW000020; **Delphi:** SS20340; **Mobiletron:** AB-EU482

APPLICATION / APLICACIÓN:
LAND ROVER: Freelander 1.8 16V 4X4 1998>0, Freelander 1.8 I 16V 4X4 1998>0, Freelander 2.0 Di 4X4 1998>0, Freelander 2.0 Td4 4X4 2000>0, Freelander 2.5 V6 4X4 2000>0, Freelander Soft Top 1.8 4X4 2000>0, Freelander Soft Top 1.8 I 16V 4X4 1998>0, Freelander Soft Top 2.0 Di 4X4 1998>0, Freelander Soft Top 2.0 Td4 4X4 2000>0, Freelander Soft Top 2.5 V6 4X4 2000>0

GS2389 // NEW //
FRONT WHEEL SENSOR (BOTH SIDES)
REPLACES / REEMPLAZA:
Land Rover: SSW000010; **A.B.S.:** 30760; **Meat & Doria:** 901024; **Mobiletron:** AB-EU202

APPLICATION / APLICACIÓN:
LAND ROVER: Freelander 1.8 16V 4X4 1998>0, Freelander 1.8 I 16V 4X4 1998>0, Freelander 2.0 Di 4X4 1998>0, Freelander 2.0 Td4 4X4 2000>0, Freelander 2.5 V6 4X4 2000>0, Freelander Soft Top 1.8 4X4 2000>0, Freelander Soft Top 1.8 I 16V 4X4 1998>0, Freelander Soft Top 2.0 Di 4X4 1998>0, Freelander Soft Top 2.0 Td4 4X4 2000>0, Freelander Soft Top 2.5 V6 4X4 2000>0

GS2391 // NEW //
REAR WHEEL SENSOR (BOTH SIDES)
REPLACES / REEMPLAZA:
Land Rover: SSW500060, SSW5000080; **A.B.S.:** 31437

APPLICATION / APLICACIÓN:
LANDROVER: Defender Cabrio 2.2 Td4 4X4 2011>0, Defender Cabrio 2.4 Td4 4X4 2007>0, Defender Pickup 2.2 Td4 4X4 2011>0, Defender Pickup 2.4 Td4 4X4 2007>0, Defender Platform/Chassis 2.4 Td4 4X4 2007>0, Defender Station Wagon 2.2 Td4 4X4 2011>0, Defender Station Wagon 2.4 Td4 4X4 2007>0, Defender Station Wagon 2.4 Td4 4X4 2006>0

GS2392 // NEW //
FRONT WHEEL SENSOR (BOTH SIDES)
REPLACES / REEMPLAZA:
Mercedes-Benz: 2215400317, 2219050001, 2215401217, 2219055700, A22019050001, A2219055700, A2215400317, A2215401217, 0986594593; **Bosch:** 0 986 594 593;

Delphi: SS20542; **Meat & Doria:** 90651; **Mobiletron:** AB-EU292

APPLICATION / APLICACIÓN:
MERCEDES-BENZ: S-Class S 280 2006>0, S-Class S 300 2006>0, S-Class S 320 Cdi 2005>0, S-Class S 350 2005>0, S-Class S 350 Bluetec 2011>0, S-Class S 350 Cdi 2009>0, S-Class S 350 Cgi 2011>0, S-Class S 400 Hybrid 2009>0, S-Class S 420 Cdi 2006>0, S-Class S 450 2005>0, S-Class S 450 Cdi 2009>0, S-Class S 500 2005>0, S-Class S 500 Cgi 2011>0, S-Class S 600 2005>0, S-Class S 63 Amg 2011>0, S-Class S 63 Amg 2006>0, S-Class S 65 Amg 2005>0, S-Class Coupe Cl 500 2006>0, S-Class Coupe Cl 500 2011>0, S-Class Coupe Cl 600 2006>0, S-Class Coupe Cl 63 Amg 2010>0, S-Class Coupe Cl 63 Amg 2006>0, S-Class Coupe Cl 65 Amg 2006>0

GS2393 // NEW //
REAR WHEEL SENSOR (BOTH SIDES)
REPLACES / REEMPLAZA:
Mercedes-Benz: 2215400117, 2219056000, A2215400117, A2219056000, 0986594592; **Bosch:** 0 986 594 592; **Delphi:** SS20541; **Meat & Doria:** 90652; **Mobiletron:** AB-EU236

APPLICATION / APLICACIÓN:
MERCEDES-BENZ: S-Class S 280 2006>0, S-Class S 300 2006>0, S-Class S 320 Cdi 2005>0, S-Class S 320 Cdi 4-Matic 2005>0, S-Class S 350 2005>0, S-Class S 350 4-Matic 2008>0, S-Class S 420 Cdi 2006>0, S-Class S 450 2005>0, S-Class S 450 4-Matic 2005>0, S-Class S 450 Cdi 2009>0, S-Class S 500 2005>0, S-Class S 500 4-Matic 2005>0, S-Class S 600 2005>0, S-Class S 63 Amg 2006>0, S-Class S 65 Amg 2006>0, S-Class Coupe Cl 500 2006>0, S-Class Coupe Cl 500 4-Matic 2008>0, S-Class Coupe Cl 600 2006>0, S-Class Coupe Cl 63 Amg 2006>0, S-Class Coupe Cl 65 Amg 2006>0

GS2394 // NEW //
FRONT WHEEL SENSOR (BOTH SIDES)
REPLACES / REEMPLAZA:
Mercedes-Benz: 2205400217, 2205400117, A2205400217, A2205400117, 0265007001, 0265007002; **Meat & Doria:** 90135

APPLICATION / APLICACIÓN:
MERCEDES-BENZ: S-Class S 280 1998>0, S-Class S 320 1998>0, S-Class S 320 Cdi 2002>0, S-Class S 320 Cdi 1999>0, S-Class S 350 2002>0, S-Class S 400 Cdi 2000>0, S-Class S 430 1998>0, S-Class S 500 1998>0, S-Class S 55 Amg 1999>0, S-Class S 55 Amg Kompressor 2002>0, S-Class S 600 2000>0, S-Class Coupe Cl 500 1999>0, S-Class Coupe Cl 55 Amg 1999>0, S-Class Coupe Cl 55 Amg Kompressor 2002>0, S-Class Coupe Cl 600 1999>0

GS2395 // NEW //
REAR WHEEL SENSOR (LEFT SIDE)
REPLACES / REEMPLAZA:
Mercedes-Benz: 2205400417, A2205400417, 225401717, A225401717, 0265007007, 0265007008, 0265007121; **Delphi:** SS20237; **Meat & Doria:** 90137; **Mobiletron:** AB-EU086

APPLICATION / APLICACIÓN:
MERCEDES-BENZ: S-Class S 280 1998>0, S-Class S 320 1998>0, S-Class S 320 Cdi 2002>0, S-Class S 320 Cdi 1999>0, S-Class S 350 2002>0, S-Class S 350 4-Matic 2003>0, S-Class S 400 Cdi 2000>0, S-Class S 430 1998>0, S-Class S 430 4-Matic 2002>0, S-Class S 500 1998>0, S-Class S 500 4-Matic 2002>0, S-Class S 55 Amg 1999>0, S-Class S 55 Amg Kompressor 2002>0, S-Class S 600 2002>0, S-Class S 600 2000>0, S-Class S 65 Amg 2004>0, S-Class Coupe Cl 500 1999>0, S-Class Coupe Cl 55 Amg 1999>0, S-Class Coupe Cl 600 2002>0, S-Class Coupe Cl 600 1999>0

GS2396 // NEW //
REAR WHEEL SENSOR (RIGHT SIDE)
REPLACES / REEMPLAZA:
Mercedes-Benz: 2205400517, A2205400517, 2205401817, A2205401817, 0265007006, 0265007005, 0265007123;

Bosch: 0 265 007 006; **Delphi:** SS20220; **Meat & Doria:** 90136; **Mobiletron:** AB-EU125

APPLICATION / APLICACIÓN:
MERCEDES-BENZ: S-Class S 280 1998>0, S-Class S 320 1998>0, S-Class S 320 Cdi 2002>0, S-Class S 320 Cdi 1999>0, S-Class S 350 2002>0, S-Class S 350 4-Matic 2003>0, S-Class S 400 Cdi 2000>0, S-Class S 430 1998>0, S-Class S 430 4-Matic 2002>0, S-Class S 500 1998>0, S-Class S 500 4-Matic 2002>0, S-Class S 55 Amg 1999>0, S-Class S 600 2000>0, S-Class S 65 Amg 2004>0, S-Class Coupe Cl 500 1999>0, S-Class Coupe Cl 55 Amg 1999>0, S-Class Coupe Cl 600 1999>0

GS2397 // NEW //
FRONT WHEEL SENSOR (BOTH SIDES)
REPLACES / REEMPLAZA:
Mercedes-Benz: 2045400117, A2045400117, 2035400417, A2035400417, 2045400517, 0986594545, 0986594543, 2049057900, A2049052905, 2049052905, 0986594548;

Bosch: 0 986 594 545; **Delphi:** SS20124; **MM:** 172100084010; **Meat & Doria:** 90205; **Mobiletron:** AB-EU150

APPLICATION / APLICACIÓN:
MERCEDES-BENZ: C-Class C 180 Cdi 2011>0, C-Class C 180 Cgi 2007>0, C-Class C 180 Kompressor 2008>0, C-Class C 180 Kompressor 2007>0, C-Class C 200 2011>0, C-Class C 200 Cdi 2011>0, C-Class C 200 Cdi 2007>0, C-Class C 200 Cgi 2007>0, C-Class C 200 Kompressor 2007>0, C-Class C 220 Cdi 2008>0, C-Class C 220 Cdi 2007>0, C-Class C 230 2007>0, C-Class C 230 4-Matic 2007>0, C-Class C 250 Cdi 2008>0, C-Class C 250 Cgi 2009>0, C-Class C 280 2007>0, C-Class C 280 4-Matic 2007>0, C-Class C 300 2009>0, C-Class C 300 4-Matic 2007>0, C-Class C 320 Cdi 2007>0, C-Class C 350 2007>0, C-Class C 350 4-Matic 2007>0, C-Class C 350 Cdi 2009>0, C-Class C 350 Cgi 2008>0, C-Class T-Model C 180 Cgi 2009>0, C-Class T-Model C 180 Kompressor 2008>0, C-Class T-Model C 180 Kompressor 2007>0, C-Class T-Model C 200 Cdi 2007>0, C-Class T-Model C 200 Cgi 2007>0, C-Class T-Model C 200 Kompressor 2007>0, C-Class T-Model C 220 Cdi 2008>0, C-Class T-Model C 220 Cdi 2007>0, C-Class T-Model C 230 2007>0, C-Class T-Model C 250 Cdi 2009>0, C-Class T-Model C 250 Cgi 2009>0, C-Class T-Model C 280 2007>0, C-Class T-Model C 300 2007>0, C-Class T-Model C 320 Cdi 2007>0, C-Class T-Model C 350 2007>0, C-Class T-Model C 350 Cdi 2007>0

GS2398 // NEW //

REAR WHEEL SENSOR (LEFT SIDE)

REPLACES / REEMPLAZA:

Mercedes-Benz: 2035400117, 2035401317, A2035401317, 1715400117, A1715400117, 1725400617, 0986594541, 0986594549

APPLICATION / APLICACIÓN:

MERCEDES-BENZ: Slk 200 Kompressor 2004>0, Slk 200 Kompressor 2008>0, Slk 280 2005>0, Slk 300 2009>0, Slk 350 2004>0, Slk 350 2008>0, Slk 55 Amg 2004>0



GS2399 // NEW //

REAR WHEEL SENSOR (BOTH SIDES)

REPLACES / REEMPLAZA:

Mercedes-Benz: 20454001317, A20454001317, 2045401317, A2045401317, 0986594546, 0986594547; **Bosch:** 0 986 594 547; **Delphi:** SS20499; **Meat & Doria:** 90637; **Mobiletron:** AB-EU472

APPLICATION / APLICACIÓN:

MERCEDES-BENZ: Glk-Class 200 2013>0, Glk-Class 200 Cdi 2010>0, Glk-Class 220 Cdi 2008>0, Glk-Class 220 Cdi 4-Matic 2008>0, Glk-Class 250 2013>0, Glk-Class 250 4-Matic 2013>0, Glk-Class 250 Cdi 4-Matic 2009>0, Glk-Class 280 4-Matic 2008>0, Glk-Class 300 4-Matic 2009>0, Glk-Class 320 Cdi 4-Matic 2008>0, Glk-Class 350 2009>0, Glk-Class 350 4-Matic 2008>0, Glk-Class 350 Cdi 4-Matic 2009>0, Glk-Class 350 Cdi 4-Matic 2012>0

GS2400 // NEW //

REAR WHEEL SENSOR (RIGHT SIDE)

REPLACES / REEMPLAZA:

Mercedes-Benz: 2035401417, 2035400217, A2035401517, 1715400217, A1715400217, 1725400717, 0986594542, 0986594550; **Bosch:** 0 986 594 542; **Delphi:** SS20224; **Meat & Doria:** 90183; **Mobiletron:** AB-EU085

APPLICATION / APLICACIÓN:

MERCEDES-BENZ: C-Class 3.5 2005>0, C-Class C 180 2000>0, C-Class C 180 Kompressor 2002>0, C-Class C 200 Cdi 2000>0, C-Class C 200 Cdi 2003>0, C-Class C 200 Cgi Kompressor 2003>0, C-Class C 200 Kompressor 2002>0, C-Class C 200 Kompressor 2000>0, C-Class C 220 Cdi 2000>0, C-Class C 220 Cdi 2003>0, C-Class C 230 2005>0, C-Class C 230 Kompressor 2004>0, C-Class C 240 2000>0, C-Class C 240 4-Matic 2002>0, C-Class C 270 Cdi 2000>0, C-Class C 280 2005>0, C-Class C 280 4-Matic 2005>0, C-Class C 30 Cdi Amg 2003>0, C-Class C 32 Amg Kompressor 2001>0, C-Class C 320 2000>0, C-Class C 320 4-Matic 2002>0, C-Class C 320 Cdi 2005>0, C-Class C 350 2005>0, C-Class C 350 4-Matic 2005>0, C-Class C 55 Amg 2004>0, C-Class Coupe C 160 Kompressor 2002>0, C-Class Coupe C 180 2001>0, C-Class Coupe C 180 Kompressor 2002>0, C-Class Coupe C 200 Cdi 2003>0, C-Class Coupe C 200 Cgi Kompressor 2003>0, C-Class Coupe C 200 Kompressor 2002>0, C-Class Coupe C 200 Kompressor 2001>0, C-Class Coupe C 220 2002>0, C-Class Coupe C 220 Cdi 2001>0, C-Class Coupe C 220 Cdi 2004>0, C-Class Coupe C 230 2005>0, C-Class Coupe C 230 Kompressor 2002>0, C-Class Coupe C 230 Kompressor 2001>0, C-Class Coupe C 30 Cdi Amg 2002>0, C-Class Coupe C 32 Amg Kompressor 2002>0, C-Class Coupe C 320 2002>0, C-Class Coupe C 350 2005>0, C-Class T-Model C 180 2001>0, C-Class T-Model C 180 Kompressor 2002>0, C-Class T-Model C 200 Cdi 2001>0, C-Class T-Model C 200 Cdi 2003>0, C-Class T-Model C 200 Cgi Kompressor 2003>0, C-Class T-Model C 200 Kompressor 2002>0, C-Class T-Model C 200 Kompressor 2001>0, C-Class T-Model C 220 Cdi 2001>0, C-Class T-Model C 220 Cdi 2004>0, C-Class T-Model C 230 2005>0, C-Class T-Model C 230 Kompressor 2004>0, C-Class T-Model C 240 2001>0, C-Class T-Model C 240 4-Matic 2002>0, C-Class T-Model C 270 Cdi 2001>0, C-Class T-Model C 280 2005>0, C-Class T-Model C 280 4-Matic 2005>0, C-Class T-Model C 30 Cdi Amg 2003>0, C-Class T-Model C 32 Amg Kompressor 2001>0, C-Class T-Model C 320 2001>0, C-Class T-Model C 320 4-Matic 2002>0, C-Class T-Model C 320 Cdi 2005>0, C-Class T-Model C 350 2005>0, C-Class T-Model C 350 4-Matic 2005>0, C-Class T-Model C 55 Amg 2004>0, C-Class Clc 160 2009>0, C-Class Clc 180 Kompressor 2008>0, C-Class Clc 200 Cdi 2008>0, C-Class Clc 200 Kompressor 2008>0, C-Class Clc 220 Cdi 2008>0, C-Class Clc 230 2008>0, C-Class Clc 350 2008>0, Clk 200 Cgi 2003>0, Clk 200 Kompressor 2006>0, Clk 200 Kompressor 2002>0, Clk 220 Cdi 2005>0, Clk 240 2002>0, Clk 270 Cdi 2002>0, Clk 280 2005>0, Clk 320 2002>0, Clk 320 Cdi 2005>0, Clk 350 2005>0, Clk 500 2006>0, Clk 500 2002>0, Clk 55 Amg 2002>0, Clk 63 Amg 2006>0, Clk Convertible Clk 200 Kompressor 2006>0, Clk Convertible Clk 200 Kompressor 2003>0, Clk Convertible Clk 240 2003>0, Clk Convertible Clk 280 2005>0, Clk Convertible Clk 320 2003>0, Clk Convertible Clk 320 Cdi 2005>0, Clk Convertible Clk 350 2005>0, Clk Convertible Clk 500 2006>0, Clk Convertible Clk 500 2003>0, Clk Convertible Clk 55 Amg 2002>0, Clk Convertible Clk 63 Amg 2006>0



GS2401 // NEW //

FRONT WHEEL SENSOR (BOTH SIDES)

REPLACES / REEMPLAZA:

Mercedes-Benz: 2115401317; **Mobiletron:** 172100103010, AB-EU101; **Meat & Doria:** 90278

APPLICATION / APLICACIÓN:

MERCEDES-BENZ: Cls Cls 280 2008>0, Cls Cls 300 2009>0, Cls Cls 320 Cdi 2005>0, Cls Cls 350 2004>0, Cls Cls 350 2006>0, Cls Cls 350 Cdi 2009>0, Cls Cls 500 2006>0, Cls Cls 500 2004>0, Cls Cls 55 Amg 2005>0, Cls Cls 63 Amg 2006>0, E-Class E 200 Cdi 2002>0, E-Class E 200 Cdi 2006>0, E-Class E 200 Kompressor 2006>0, E-Class E 200 Kompressor 2002>0, E-Class E 200 Ngt 2004>0, E-Class E 220 Cdi 2003>0, E-Class E 220 Cdi 2002>0, E-Class E 220 Cdi 2006>0, E-Class E 230 2007>0, E-Class E 240 2002>0, E-Class E 270 Cdi 2002>0, E-Class E 280 2005>0, E-Class E 280 4-Matic 2006>0, E-Class E 280 Cdi 2005>0, E-Class E 280 Cdi 2004>0, E-Class E 280 Cdi 4-Matic 2005>0, E-Class E 300 Bluetec 2007>0, E-Class E 320 2002>0, E-Class E 320 Cdi 2005>0, E-Class E 320 Cdi 2002>0, E-Class E 320 Cdi 4-Matic 2005>0, E-Class E 350 2005>0, E-Class E 350 4-Matic 2005>0, E-Class E 350 Cgi 2007>0, E-Class E 400 Cdi 2003>0, E-Class E 420 Cdi 2006>0, E-Class E 500 2002>0, E-Class E 500 2006>0, E-Class E 500 4-Matic 2006>0, E-Class E 55 Amg Kompressor 2002>0, E-Class E 63 Amg 2006>0, E-Class T-Model 350 Cgi 2006>0, E-Class T-Model E 200 Cdi 2006>0, E-Class T-Model E 200 Kompressor 2006>0, E-Class T-Model E 200 T Kompressor 2003>0, E-Class T-Model E 220 Cdi 2003>0, E-Class T-Model E 220 T Cdi 2003>0, E-Class T-Model E 220 T Cdi 2006>0, E-Class T-Model E 230 T 2007>0, E-Class T-Model E 240 T 2003>0, E-Class T-Model E 270 T Cdi 2003>0, E-Class T-Model E 280 T 2005>0, E-Class T-Model E 280 T 4-Matic 2005>0, E-Class T-Model E 280 T Cdi 2005>0, E-Class T-Model E 280 T Cdi 2004>0, E-Class T-Model E 280 T Cdi 4-Matic 2005>0, E-Class T-Model E 320 T 2003>0, E-Class T-Model E 320 T Cdi 2005>0, E-Class T-Model E 320 T Cdi 2003>0, E-Class T-Model E 320 T Cdi 4-Matic 2005>0, E-Class T-Model E 350 T 2005>0, E-Class T-Model E 350 T 4-Matic 2005>0, E-Class T-Model E 500 T 2003>0, E-Class T-Model E 500 T 2006>0, E-Class T-Model E 500 T 4-Matic 2006>0, E-Class T-Model E 55 T Amg Kompressor 2003>0, E-Class T-Model E 63 Amg 2006>0, SI 55 Amg 2006>0, SI 55 Amg 2001>0, SI 55 Amg Kompressor 2002>0, SI 65 Amg 2004>0, SI 65 Amg Black Series 2008>0



GS2402 // NEW //

REAR WHEEL SENSOR (BOTH SIDES)

REPLACES / REEMPLAZA:

Mercedes-Benz: 2115403017, A2115402417, 2115401917, A2115401217, 2115402417, A2115401917, A2115403017, 2125400317, A2125400317, 0986594563, 0265008047; **Bosch:** 0 265 007 500, 0 986 594 563; **Delphi:** SS20229; **MM:** 172100104010; **Meat & Doria:** 90279; **Mobiletron:** AB-EU219

APPLICATION / APLICACIÓN:

MERCEDES-BENZ: E-Class E 200 Cdi 2002>0, E-Class E 200 Ngt 2004>0, E-Class E 220 Cdi 2002>0, E-Class E 240 4-Matic 2003>0, E-Class E 270 Cdi 2002>0, E-Class E 320 4-Matic 2003>0, E-Class E 320 Cdi 2002>0, E-Class E 400 Cdi 2003>0, E-Class E 500 4-Matic 2003>0, E-Class E 55 Amg Kompressor 2002>0, E-Class Platparam/Chassis E 220 Cdi 2003>0, E-Class Platparam/Chassis E 270 Cdi 2003>0, E-Class T-Model E 200 T Kompressor 2003>0, E-Class T-Model E 220 Cdi 2003>0, E-Class T-Model E 220 T Cdi 2003>0, E-Class T-Model E 240 T 2003>0, E-Class T-Model E 240 T 4-Matic 2003>0, E-Class T-Model E 270 T Cdi 2003>0, E-Class T-Model E 320 T 2003>0, E-Class T-Model E 320 T 4-Matic 2003>0, E-Class T-Model E 320 T Cdi 2003>0, E-Class T-Model E 500 T 2003>0, E-Class T-Model E 500 T 4-Matic 2003>0, E-Class T-Model E 55 T Amg Kompressor 2003>0



GS2403 // NEW //
FRONT WHEEL SENSOR (RIGHT SIDE)
REPLACES / REEMPLAZA:
Mercedes-Benz: 2125400217, A2125400217, 0265008133; **Bosch:** 0 265 008 133; **A.B.S.:** 31405; **Mobiletron:** AB-EU363

APPLICATION / APLICACIÓN:
MERCEDES-BENZ: Cls Cls 250 Cdi / Bluetec / D 2011>0, Cls Cls 350 2011>0, Cls Cls 350 Bluetec / D 2013>0, Cls Cls 350 Cdi / D 2011>0, Cls Cls 500 2011>0, Cls Cls 63 Amg 2011>0, Cls Shooting Brake Cls 250 Cdi / Bluetec / D 2012>0, Cls Shooting Brake Cls 350 2012>0, Cls Shooting Brake Cls 350 Cdi / D 2012>0, Cls Shooting Brake Cls 500 2012>0, Cls Shooting Brake Cls 63 Amg 2012>0, Cls Shooting Brake Cls 63 Amg 2013>0, E-Class E 200 Cdi / Bluetec 2009>0, E-Class E 200 Cgi 2009>0, E-Class E 200 Ngt 2011>0, E-Class E 220 Cdi 2009>0, E-Class E 220 Cdi / Bluetec 2009>0, E-Class E 250 Cdi / Bluetec 2009>0, E-Class E 250 Cgi 2009>0, E-Class E 300 2009>0, E-Class E 300 2011>0, E-Class E 300 Cdi 2009>0, E-Class E 300 Cdi / Bluetec 2011>0, E-Class E 350 2009>0, E-Class E 350 2011>0, E-Class E 350 Bluetec 2009>0, E-Class E 350 Cdi 2011>0, E-Class E 350 Cdi 2009>0, E-Class E 350 Cgi 2009>0, E-Class E 500 2009>0, E-Class E 500 2011>0, E-Class E 63 Amg 2011>0, E-Class E 63 Amg 2009>0, E-Class T-Model E 200 Cdi / Bluetec 2009>0, E-Class T-Model E 200 Cgi 2009>0, E-Class T-Model E 220 Cdi 2009>0, E-Class T-Model E 220 Cdi / Bluetec 2009>0, E-Class T-Model E 250 Cdi / Bluetec 2009>0, E-Class T-Model E 250 Cgi 2009>0, E-Class T-Model E 300 2009>0, E-Class T-Model E 300 2011>0, E-Class T-Model E 300 Cdi 2009>0, E-Class T-Model E 300 Cdi / Bluetec 2009>0, E-Class T-Model E 300 Cdi / Bluetec 2011>0, E-Class T-Model E 350 2009>0, E-Class T-Model E 350 2011>0, E-Class T-Model E 350 Bluetec 2009>0, E-Class T-Model E 350 Cdi 2011>0, E-Class T-Model E 350 Cdi 2009>0, E-Class T-Model E 350 Cgi 2009>0, E-Class T-Model E 500 2009>0, E-Class T-Model E 500 2011>0, E-Class T-Model E 63 Amg 2011>0, E-Class T-Model E 63 Amg 2009>0

GS2404 // NEW //
FRONT WHEEL SENSOR (LEFT SIDE)
REPLACES / REEMPLAZA:
Mercedes-Benz: 2125400117, A2125400117; **Bosch:** 0 265 008 135; **A.B.S.:** 31471

APPLICATION / APLICACIÓN:
MERCEDES-BENZ: Cls Cls 250 Cdi / Bluetec / D 2011>0, Cls Cls 350 2011>0, Cls Cls 350 Bluetec / D 2013>0, Cls Cls 350 Cdi / D 2011>0, Cls Cls 500 2011>0, Cls Cls 63 Amg 2011>0, Cls Shooting Brake Cls 250 Cdi / Bluetec / D 2012>0, Cls Shooting Brake Cls 350 2012>0, Cls Shooting Brake Cls 350 Cdi / D 2012>0, Cls Shooting Brake Cls 500 2012>0, Cls Shooting Brake Cls 63 Amg 2012>0, Cls Shooting Brake Cls 63 Amg 2013>0, E-Class E 200 Cdi / Bluetec 2009>0, E-Class E 200 Cgi 2009>0, E-Class E 200 Ngt 2011>0, E-Class E 220 Cdi 2009>0, E-Class E 220 Cdi / Bluetec 2009>0, E-Class E 250 Cdi / Bluetec 2009>0, E-Class E 250 Cgi 2009>0, E-Class E 300 2009>0, E-Class E 300 2011>0, E-Class E 300 Cdi 2009>0, E-Class E 300 Cdi / Bluetec 2011>0, E-Class E 350 2009>0, E-Class E 350 2011>0, E-Class E 350 Bluetec 2009>0, E-Class E 350 Cdi 2011>0, E-Class E 350 Cdi 2009>0, E-Class E 350 Cgi 2009>0, E-Class E 500 2009>0, E-Class E 500 2011>0, E-Class E 63 Amg 2011>0, E-Class E 63 Amg 2009>0, E-Class T-Model E 200 Cdi / Bluetec 2009>0, E-Class T-Model E 200 Cgi 2009>0, E-Class T-Model E 220 Cdi 2009>0, E-Class T-Model E 220 Cdi / Bluetec 2009>0, E-Class T-Model E 250 Cdi / Bluetec 2009>0, E-Class T-Model E 250 Cgi 2009>0, E-Class T-Model E 300 2009>0, E-Class T-Model E 300 2011>0, E-Class T-Model E 300 Cdi 2009>0, E-Class T-Model E 300 Cdi / Bluetec 2009>0, E-Class T-Model E 300 Cdi / Bluetec 2011>0, E-Class T-Model E 350 2009>0, E-Class T-Model E 350 2011>0, E-Class T-Model E 350 Bluetec 2009>0, E-Class T-Model E 350 Cdi 2011>0, E-Class T-Model E 350 Cdi 2009>0, E-Class T-Model E 350 Cgi 2009>0, E-Class T-Model E 500 2009>0, E-Class T-Model E 500 2011>0, E-Class T-Model E 63 Amg 2011>0, E-Class T-Model E 63 Amg 2009>0

GS2405 // NEW //
FRONT WHEEL SENSOR (BOTH SIDES)
REPLACES / REEMPLAZA:
Mercedes-Benz: 1644405141, 1644405541, 1645400917, 1645401617, 1649058200; **Meat & Doria:** 90574;

Mobiletron: AB-EU360

APPLICATION / APLICACIÓN:
MERCEDES-BENZ: Gl-Class Gl 320 Cdi / 350 Bluetec 4-Matic 2009>0, Gl-Class Gl 320 Cdi 4-Matic 2006>0, Gl-Class Gl 350 Cdi 4-Matic 2009>0, Gl-Class Gl 350 Cdi 4-Matic 2010>0, Gl-Class Gl 420 Cdi 4-Matic 2006>0, Gl-Class Gl 450 4-Matic 2006>0, Gl-Class Gl 450 Cdi 4-Matic 2009>0, Gl-Class Gl 500 4-Matic 2006>0, M-Class MI 280 Cdi 4-Matic 2005>0, M-Class MI 300 Cdi 4-Matic 2009>0, M-Class MI 300 Cdi 4-Matic 2010>0, M-Class MI 320 Cdi 4-Matic 2005>0, M-Class MI 350 4-Matic 2005>0, M-Class MI 350 Cdi 4-Matic 2009>0, M-Class MI 420 Cdi 4-Matic 2006>0, M-Class MI 450 Cdi 4-Matic 2009>0, M-Class MI 500 4-Matic 2007>0, M-Class MI 500 4-Matic 2005>0, M-Class MI 63 Amg 4-Matic 2006>0

GS2406 // NEW //
REAR WHEEL SENSOR (BOTH SIDES)
REPLACES / REEMPLAZA:
Mercedes-Benz: 1644405641, 1645400717, 1649058300, 1644405241, A1645400717; **Meat & Doria:** 90575

APPLICATION / APLICACIÓN:
MERCEDES-BENZ: Gl-Class Gl 320 Cdi 4-Matic 2006>0, Gl-Class Gl 350 Cdi 4-Matic 2009>0, Gl-Class Gl 420 Cdi 4-Matic 2006>0, Gl-Class Gl 450 4-Matic 2006>0, Gl-Class Gl 450 4-Matic 2009>0, Gl-Class Gl 500 4-Matic 2006>0, M-Class MI 280 Cdi 4-Matic 2005>0, M-Class MI 300 Cdi 4-Matic 2009>0, M-Class MI 320 Cdi 4-Matic 2005>0, M-Class MI 350 4-Matic 2005>0, M-Class MI 350 Cdi 4-Matic 2009>0, M-Class MI 420 Cdi 4-Matic 2006>0, M-Class MI 500 4-Matic 2007>0, M-Class MI 500 4-Matic 2005>0, M-Class MI 63 Amg 4-Matic 2006>0, R-Class R 280 2007>0, R-Class R 280 Cdi 2006>0, R-Class R 280 Cdi 4-Matic 2006>0, R-Class R 300 2009>0, R-Class R 300 Cdi 2009>0, R-Class R 300 Cdi 4-Matic 2009>0, R-Class R 320 Cdi 4-Matic 2006>0, R-Class R 350 2007>0, R-Class R 350 4-Matic 2005>0, R-Class R 350 Cdi 4-Matic 2009>0, R-Class R 350 Cdi 4-Matic 2006>0, R-Class R 500 4-Matic 2007>0, R-Class R 500 4-Matic 2005>0, R-Class R 63 Amg 4-Matic 2006>0

GS2407 // NEW //
FRONT WHEEL SENSOR (BOTH SIDES)
REPLACES / REEMPLAZA:
Mercedes-Benz: 1665400217, 1669054002; **A.B.S.:** 31428; **Bosch:** 0 986 594 649

APPLICATION / APLICACIÓN:
MERCEDES-BENZ: Gl-Class Gl 350 Cdi / Bluetec 4-Matic 2012>0, Gl-Class Gl 400 4-Matic 2013>0, Gl-Class Gl 450 4-Matic 2012>0, Gl-Class Gl 500 4-Matic 2012>0, Gl-Class Gl 63 Amg 4-Matic 2012>0, Gle 250 D 2015>0, Gle 250 D 4-Matic 2015>0, Gle 320 4-Matic 2015>0, Gle 350 D 4-Matic 2015>0, Gle 400 4-Matic 2015>0, Gle 450 Amg 4-Matic 2015>0, Gle 500 4-Matic 2015>0, Gle 500 E 4-Matic 2015>0, Gle Amg 43 4-Matic 2016>0, Gle Amg 63 4-Matic 2015>0, Gle Amg 63 S 4-Matic 2015>0, Gle Coupe 350 D 4-Matic 2015>0, Gle Coupe 350 D 4-Matic 2017>0, Gle Coupe 400 4-Matic 2015>0, Gle Coupe 450 Amg 4-Matic 2015>0, Gle Coupe 500 4-Matic 2015>0, Gle Coupe Amg 43 4-Matic 2016>0, Gle Coupe Amg 63 4-Matic 2015>0, Gle Coupe Amg 63 S 4-Matic 2015>0, GlS 350 D 4-Matic 2015>0, GlS 400 4-Matic 2015>0, GlS 500 4-Matic 2015>0, GlS Amg 63 4-Matic 2015>0, M-Class MI 250 Cdi / Bluetec 4-Matic 2011>0, M-Class MI 300 4-Matic 2012>0, M-Class MI 350 4-Matic 2011>0, M-Class MI 350 Bluetec 4-Matic 2011>0, M-Class MI 400 4-Matic 2013>0, M-Class MI 500 4-Matic 2012>0, M-Class MI 63 Amg 4-Matic 2011>0

GS2408 // NEW //

REAR WHEEL SENSOR (BOTH SIDES)

REPLACES / REEMPLAZA:

Mercedes-Benz: 1669052701, 1669054102; A.B.S.: 31427; Bosch: 0 986 594 650

APPLICATION / APLICACIÓN:

MERCEDES-BENZ: Gl-Class Gl 350 Cdi / Bluetec 4-Matic 2012>0, Gl-Class Gl 400 4-Matic 2013>0, Gl-Class Gl 500 4-Matic 2012>0, Gl-Class Gl 63 Amg 4-Matic 2012>0, Gle 250 D 2015>0, Gle 250 D 4-Matic 2015>0, Gle 320 4-Matic 2015>0, Gle 350 D 4-Matic 2015>0, Gle 400 4-Matic 2015>0, Gle 450 Amg 4-Matic 2015>0, Gle 500 4-Matic 2015>0, Gle 500 E 4-Matic 2015>0, Gle Amg 43 4-Matic 2016>0, Gle Amg 63 4-Matic 2015>0, Gle Amg 63 S 4-Matic 2015>0, Gle Coupe 350 D 4-Matic 2015>0, Gle Coupe 350 D 4-Matic 2017>0, Gle Coupe 400 4-Matic 2015>0, Gle Coupe 450 Amg 4-Matic 2015>0, Gle Coupe 500 4-Matic 2015>0, Gle Coupe Amg 43 4-Matic 2016>0, Gle Coupe Amg 63 4-Matic 2015>0, Gle Coupe Amg 63 S 4-Matic 2015>0, GlS 350 D 4-Matic 2015>0, GlS 400 4-Matic 2015>0, GlS 500 4-Matic 2015>0, GlS Amg 63 4-Matic 2015>0, M-Class MI 250 Cdi / Bluetec 4-Matic 2011>0, M-Class MI 300 4-Matic 2012>0, M-Class MI 350 4-Matic 2011>0, M-Class MI 350 Bluetec 4-Matic 2011>0, M-Class MI 350 Cdi 4-Matic 2011>0, M-Class MI 400 4-Matic 2013>0, M-Class MI 500 4-Matic 2012>0, M-Class MI 63 Amg 4-Matic 2011>0



GS2409 // NEW //

REAR WHEEL SENSOR (LEFT SIDE)

REPLACES / REEMPLAZA:

Mercedes-Benz: A9065401117, 9065401117, A9065404317, 9065404317, A9069051001, 9069051001, 0265009340; Bosch: 0 265 009 340; Hitachi: 131440

APPLICATION / APLICACIÓN:

MERCEDES-BENZ: Sprinter 4,6-T Box 411 Cdi 2009>0, Sprinter 4,6-T Box 413 Cdi 2006>0, Sprinter 4,6-T Box 414 Cdi 2016>0, Sprinter 4,6-T Box 414 Cdi 4X4 2016>0, Sprinter 4,6-T Box 415 Cdi 2009>0, Sprinter 4,6-T Box 416 Cdi 2009>0, Sprinter 4,6-T Box 419 Cdi 2009>0, Sprinter 4,6-T Box 424 2006>0, Sprinter 4,6-T Bus 415 Cdi 2006>0, Sprinter 4,6-T Platparam/Chassis 411 Cdi 2009>0, Sprinter 4,6-T Platparam/Chassis 413 Cdi 2009>0, Sprinter 4,6-T Platparam/Chassis 414 Cdi 2016>0, Sprinter 4,6-T Platparam/Chassis 415 Cdi 2006>0, Sprinter 4,6-T Platparam/Chassis 416 Cdi 2009>0, Sprinter 4,6-T Platparam/Chassis 418 Cdi 2006>0, Sprinter 4,6-T Platparam/Chassis 419 Cdi 2009>0, Sprinter 4,6-T Platparam/Chassis 424 2006>0, Sprinter 4-T Platparam/Chassis 414 Cdi Rwd 2018>0, Sprinter 5-T Box 509 Cdi 2006>0, Sprinter 5-T Box 510 Cdi 2009>0, Sprinter 5-T Box 511 Cdi 2006>0, Sprinter 5-T Box 511 Cdi 4X4 2006>0, Sprinter 5-T Box 513 Cdi 2006>0, Sprinter 5-T Box 513 Cdi 4X4 2006>0, Sprinter 5-T Box 514 Cdi 2016>0, Sprinter 5-T Box 514 Cdi 4X4 2016>0, Sprinter 5-T Box 515 Cdi 2006>0, Sprinter 5-T Box 515 Cdi 2011>0, Sprinter 5-T Box 515 Cdi 4X4 2006>0, Sprinter 5-T Box 516 2009>0, Sprinter 5-T Box 516 Cdi 2009>0, Sprinter 5-T Box 516 Cdi 4X4 2006>0, Sprinter 5-T Box 518 Cdi 2006>0, Sprinter 5-T Box 518 Cdi 4X4 2006>0, Sprinter 5-T Box 519 Cdi / Bluetec 2009>0, Sprinter 5-T Box 519 Cdi / Bluetec 4X4 2009>0, Sprinter 5-T Bus 513 Cdi 2006>0, Sprinter 5-T Bus 515 Cdi 2006>0, Sprinter 5-T Bus 516 Cdi 2009>0, Sprinter 5-T Bus 519 Cdi / Bluetec 2009>0, Sprinter 5-T Platparam/Chassis 509 Cdi 2006>0, Sprinter 5-T Platparam/Chassis 510 Cdi 2009>0, Sprinter 5-T Platparam/Chassis 511 Cdi 2006>0, Sprinter 5-T Platparam/Chassis 511 Cdi 4X4 2006>0, Sprinter 5-T Platparam/Chassis 513 Cdi 2006>0, Sprinter 5-T Platparam/Chassis 513 Cdi 4X4 2011>0, Sprinter 5-T Platparam/Chassis 514 Cdi 2016>0, Sprinter 5-T Platparam/Chassis 514 Cdi 4X4 2016>0, Sprinter 5-T Platparam/Chassis 515 Cdi 2006>0, Sprinter 5-T Platparam/Chassis 515 Cdi 4X4 2006>0, Sprinter 5-T Platparam/Chassis 516 2008>0, Sprinter 5-T Platparam/Chassis 516 Cdi 2009>0, Sprinter 5-T Platparam/Chassis 516 Cdi 4X4 2011>0, Sprinter 5-T Platparam/Chassis 516 NgT 2008>0, Sprinter 5-T Platparam/Chassis 518 Cdi 2006>0, Sprinter 5-T Platparam/Chassis 518 Cdi 4X4 2006>0, Sprinter 5-T Platparam/Chassis 519 Cdi / Bluetec 2009>0, Sprinter 5-T Platparam/Chassis 519 Cdi / Bluetec 4X4 2009>0, Sprinter 5-T Platparam/Chassis 524 2006>0;

VW: Crafter 30-50 Box 2.0 Tdi 2011>0, Crafter 30-50 Box 2.0 Tdi 4Motion 2011>0, Crafter 30-50 Box 2.5 Tdi 2006>0, Crafter 30-50 Platparam/Chassis 2.0 Tdi 2011>0, Crafter 30-50 Platparam/Chassis 2.0 Tdi 4Motion 2011>0, Crafter 30-50 Platparam/Chassis 2.5 Tdi 2006>0



GS2410 // NEW //

REAR WHEEL SENSOR (LEFT SIDE)

REPLACES / REEMPLAZA:

Mercedes-Benz: A9065401217, A9065404417, 0265009341; A.B.S.: 31528; Bosch: 0 265 009 341

APPLICATION / APLICACIÓN:

MERCEDES-BENZ: Sprinter 4,6-T Box 411 Cdi 2009>0, Sprinter 4,6-T Box 413 Cdi 2006>0, Sprinter 4,6-T Box 414 Cdi 2016>0, Sprinter 4,6-T Box 414 Cdi 4X4 2016>0, Sprinter 4,6-T Box 415 Cdi 2009>0, Sprinter 4,6-T Box 416 Cdi 2009>0, Sprinter 4,6-T Box 419 Cdi 2009>0, Sprinter 4,6-T Box 424 2006>0, Sprinter 4,6-T Bus 415 Cdi 2006>0, Sprinter 4,6-T Platform/Chassis 411 Cdi 2009>0, Sprinter 4,6-T Platform/Chassis 413 Cdi 2009>0, Sprinter 4,6-T Platform/Chassis 414 Cdi 2016>0, Sprinter 4,6-T Platform/Chassis 415 Cdi 2006>0, Sprinter 4,6-T Platform/Chassis 416 Cdi 2009>0, Sprinter 4,6-T Platform/Chassis 418 Cdi 2006>0, Sprinter 4,6-T Platform/Chassis 419 Cdi 2009>0, Sprinter 4,6-T Platform/Chassis 424 2006>0, Sprinter 4-T Platform/Chassis 414 Cdi Rwd 2018>0, Sprinter 5-T Box 509 Cdi 2006>0, Sprinter 5-T Box 510 Cdi 2009>0, Sprinter 5-T Box 511 Cdi 2006>0, Sprinter 5-T Box 511 Cdi 4X4 2006>0, Sprinter 5-T Box 513 Cdi 2006>0, Sprinter 5-T Box 513 Cdi 4X4 2006>0, Sprinter 5-T Box 514 Cdi 2016>0, Sprinter 5-T Box 514 Cdi 4X4 2016>0, Sprinter 5-T Box 515 Cdi 2006>0, Sprinter 5-T Box 515 Cdi 2011>0, Sprinter 5-T Box 515 Cdi 4X4 2006>0, Sprinter 5-T Box 516 2009>0, Sprinter 5-T Box 516 Cdi 2009>0, Sprinter 5-T Box 516 Cdi 4X4 2006>0, Sprinter 5-T Box 518 Cdi 2006>0, Sprinter 5-T Box 518 Cdi 4X4 2006>0, Sprinter 5-T Box 519 Cdi / Bluetec 2009>0, Sprinter 5-T Box 519 Cdi / Bluetec 4X4 2009>0, Sprinter 5-T Box 524 2006>0, Sprinter 5-T Bus 513 Cdi 2006>0, Sprinter 5-T Bus 515 Cdi 2006>0, Sprinter 5-T Bus 516 Cdi 2009>0, Sprinter 5-T Bus 519 Cdi / Bluetec 2009>0, Sprinter 5-T Platform/Chassis 509 Cdi 2006>0, Sprinter 5-T Platform/Chassis 510 Cdi 2009>0, Sprinter 5-T Platform/Chassis 511 Cdi 2006>0, Sprinter 5-T Platform/Chassis 511 Cdi 4X4 2006>0, Sprinter 5-T Platform/Chassis 513 Cdi 2006>0, Sprinter 5-T Platform/Chassis 513 Cdi 4X4 2011>0, Sprinter 5-T Platform/Chassis 514 Cdi 2016>0, Sprinter 5-T Platform/Chassis 514 Cdi 4X4 2016>0, Sprinter 5-T Platform/Chassis 515 Cdi 2006>0, Sprinter 5-T Platform/Chassis 515 Cdi 4X4 2006>0, Sprinter 5-T Platform/Chassis 516 2008>0, Sprinter 5-T Platform/Chassis 516 Cdi 2009>0, Sprinter 5-T Platform/Chassis 516 Cdi 4X4 2011>0, Sprinter 5-T Platform/Chassis 516 NgT 2008>0, Sprinter 5-T Platform/Chassis 518 Cdi 2006>0, Sprinter 5-T Platform/Chassis 518 Cdi 4X4 2006>0, Sprinter 5-T Platform/Chassis 519 Cdi / Bluetec 2009>0, Sprinter 5-T Platform/Chassis 519 Cdi / Bluetec 4X4 2009>0, Sprinter 5-T Platform/Chassis 524 2006>0;

VW: Crafter 30-50 Box 2.0 Tdi 2011>0, Crafter 30-50 Box 2.0 Tdi 4Motion 2011>0, Crafter 30-50 Box 2.5 Tdi 2006>0, Crafter 30-50 Platform/Chassis 2.0 Tdi 2011>0, Crafter 30-50 Platform/Chassis 2.0 Tdi 4Motion 2011>0, Crafter 30-50 Platform/Chassis 2.5 Tdi 2006>0



GS2413 // NEW //
FRONT WHEEL SENSOR (BOTH SIDES)
REPLACES / REEMPLAZA:
Mercedes-Benz: 9015421717, 9015420817, A9015421717, A9015420817, 2D0927807, 0265004009, 9015420318, A9015420318; **Bosch:** 0 265 004 009; **Delphi:** SS20210; **Cargo:** 181912; **Meat & Doria:** 90197; **Mobiletron:** AB-EU389

APPLICATION / APLICACIÓN:

MERCEDES-BENZ: Sprinter 2-T Box 208 Cdi 2000>0, Sprinter 2-T Box 208 D 1995>0, Sprinter 2-T Box 210 D 1997>0, Sprinter 2-T Box 211 Cdi 2000>0, Sprinter 2-T Box 212 D 1995>0, Sprinter 2-T Box 213 Cdi 2000>0, Sprinter 2-T Box 214 1995>0, Sprinter 2-T Box 214 Ngt 1995>0, Sprinter 2-T Box 216 Cdi 2000>0, Sprinter 2-T Bus 208 Cdi 2000>0, Sprinter 2-T Bus 208 D 1995>0, Sprinter 2-T Bus 210 D 1997>0, Sprinter 2-T Bus 211 Cdi 2000>0, Sprinter 2-T Bus 212 D 1995>0, Sprinter 2-T Bus 213 Cdi 2000>0, Sprinter 2-T Bus 214 1995>0, Sprinter 2-T Bus 214 Ngt 1995>0, Sprinter 2-T Bus 216 Cdi 2000>0, Sprinter 2-T Platparam/Chassis 208 Cdi 2000>0, Sprinter 2-T Platparam/Chassis 208 D 1995>0, Sprinter 2-T Platparam/Chassis 210 D 1997>0, Sprinter 2-T Platparam/Chassis 211 Cdi 2000>0, Sprinter 2-T Platparam/Chassis 212 D 1995>0, Sprinter 2-T Platparam/Chassis 213 Cdi 2000>0, Sprinter 2-T Platparam/Chassis 214 1995>0, Sprinter 2-T Platparam/Chassis 214 Ngt 1995>0, Sprinter 2-T Platparam/Chassis 216 Cdi 2000>0, Sprinter 3-T Box 308 Cdi 2000>0, Sprinter 3-T Box 308 D 2.3 1995>0, Sprinter 3-T Box 310 D 2.9 1995>0, Sprinter 3-T Box 310 D 2.9 4X4 1997>0, Sprinter 3-T Box 311 Cdi 2000>0, Sprinter 3-T Box 311 Cdi 4X4 2002>0, Sprinter 3-T Box 312 D 2.9 1995>0, Sprinter 3-T Box 312 D 2.9 4X4 1997>0, Sprinter 3-T Box 313 Cdi 2000>0, Sprinter 3-T Box 313 Cdi 4X4 2002>0, Sprinter 3-T Box 314 1995>0, Sprinter 3-T Box 314 4X4 2002>0, Sprinter 3-T Box 314 Ngt 1995>0, Sprinter 3-T Box 316 Cdi 2000>0, Sprinter 3-T Box 316 Cdi 4X4 2002>0, Sprinter 3-T Bus 308 Cdi 2000>0, Sprinter 3-T Bus 308 D 1995>0, Sprinter 3-T Bus 310 D 1997>0, Sprinter 3-T Bus 310 D 4X4 1997>0, Sprinter 3-T Bus 311 Cdi 2000>0, Sprinter 3-T Bus 311 Cdi 4X4 2002>0, Sprinter 3-T Bus 312 D 2.9 1995>0, Sprinter 3-T Bus 312 D 2.9 4X4 1997>0, Sprinter 3-T Bus 313 Cdi 2000>0, Sprinter 3-T Bus 313 Cdi 4X4 2002>0, Sprinter 3-T Bus 314 1995>0, Sprinter 3-T Bus 314 4X4 2002>0, Sprinter 3-T Bus 314 Ngt 1995>0, Sprinter 3-T Bus 316 Cdi 2000>0, Sprinter 3-T Bus 316 Cdi 4X4 2002>0, Sprinter 3-T Platparam/Chassis 308 Cdi 2000>0, Sprinter 3-T Platparam/Chassis 308 D 2.3 1995>0, Sprinter 3-T Platparam/Chassis 310 D 2.9 1995>0, Sprinter 3-T Platparam/Chassis 311 Cdi 2000>0, Sprinter 3-T Platparam/Chassis 311 Cdi 4X4 2002>0, Sprinter 3-T Platparam/Chassis 312 D 2.9 1995>0, Sprinter 3-T Platparam/Chassis 312 D 2.9 1998>0, Sprinter 3-T Platparam/Chassis 313 Cdi 2000>0, Sprinter 3-T Platparam/Chassis 313 Cdi 4X4 2002>0, Sprinter 3-T Platparam/Chassis 314 1995>0, Sprinter 3-T Platparam/Chassis 314 4X4 2002>0, Sprinter 3-T Platparam/Chassis 314 Ngt 1995>0, Sprinter 3-T Platparam/Chassis 316 Cdi 2000>0, Sprinter 3-T Platparam/Chassis 316 Cdi 4X4 2002>0, Sprinter 4-T Box 408 Cdi 2000>0, Sprinter 4-T Box 408 D 1996>0, Sprinter 4-T Box 410 D 1996>0, Sprinter 4-T Box 410 D 4X4 1997>0, Sprinter 4-T Box 411 Cdi 2000>0, Sprinter 4-T Box 411 Cdi 4X4 2000>0, Sprinter 4-T Box 412 D 1996>0, Sprinter 4-T Box 412 D 4X4 1997>0, Sprinter 4-T Box 413 Cdi 2000>0, Sprinter 4-T Box 413 Cdi 4X4 2000>0, Sprinter 4-T Box 414 1996>0, Sprinter 4-T Box 414 4X4 1997>0, Sprinter 4-T Box 414 D 4X4 1997>0, Sprinter 4-T Box 416 Cdi 2000>0, Sprinter 4-T Box 416 Cdi 4X4 2000>0, Sprinter 4-T Bus 408 Cdi 2000>0, Sprinter 4-T Bus 411 Cdi 2000>0, Sprinter 4-T Bus 413 Cdi 2000>0, Sprinter 4-T Bus 414 1996>0, Sprinter 4-T Bus 414 1996>0, Sprinter 4-T Platparam/Chassis 408 Cdi 2000>0, Sprinter 4-T Platparam/Chassis 408 D 1996>0, Sprinter 4-T Platparam/Chassis 410 D 1996>0, Sprinter 4-T Platparam/Chassis 410 D 4X4 1997>0, Sprinter 4-T Platparam/Chassis 411 Cdi 2000>0, Sprinter 4-T Platparam/Chassis 411 Cdi 4X4 2000>0, Sprinter 4-T Platparam/Chassis 412 D 1996>0, Sprinter 4-T Platparam/Chassis 412 D 4X4 1997>0, Sprinter 4-T Platparam/Chassis 413 Cdi 2000>0, Sprinter 4-T Platparam/Chassis 413 Cdi 4X4 2000>0, Sprinter 4-T Platparam/Chassis 414 1995>0, Sprinter 4-T Platparam/Chassis 414 4X4 1997>0, Sprinter 4-T Platparam/Chassis 416 Cdi 2000>0, Sprinter 4-T Platparam/Chassis 416 Cdi 4X4 2000>0, Sprinter 5-T Platparam/Chassis 616 Cdi 2001>0, Sprinter Dump Truck 616 Cdi 2001>0;

VW: Lt 28-35 li Bus 2.3 1996>0, Lt 28-35 li Bus 2.5 Sdi 1996>0, Lt 28-35 li Bus 2.5 Tdi 1996>0, Lt 28-35 li Bus 2.8 Tdi 1997>0, Lt 28-46 li Box 2.3 1996>0, Lt 28-46 li Box 2.5 Sdi 1996>0, Lt 28-46 li Box 2.5 Tdi 1996>0, Lt 28-46 li Box 2.8 Tdi 1997>0, Lt 28-46 li Platparam/Chassis 2.3 1996>0, Lt 28-46 li Platparam/Chassis 2.5 Sdi 1996>0, Lt 28-46 li Platparam/Chassis 2.5 Tdi 1996>0, Lt 28-46 li Platparam/Chassis 2.8 Tdi 1997>0

GS2414 // NEW //
FRONT WHEEL SENSOR (BOTH SIDES)
REPLACES / REEMPLAZA:
Mercedes-Benz: 1725400017, 1729056101; A.B.S.: 31502; **Meat & Doria:** 90902, 90902E

APPLICATION / APLICACIÓN:

MERCEDES-BENZ: Slc 180 2016>0, Slc 200 2015>0, Slc 250 D 2016>0, Slc 300 2015>0, Slc Amg Slc 43 2016>0, Slk 200 2015>0, Slk 200 2011>0, Slk 250 2011>0, Slk 250 Cdi / D 2012>0, Slk 300 2015>0, Slk 350 2011>0, Slk 55 Amg 2012>0

GS2415 // NEW //
FRONT WHEEL SENSOR (BOTH SIDES)
REPLACES / REEMPLAZA:
Mercedes-Benz: 1695401417, A1695401417, 0265007478, 0265007477; **A.B.S.:** 31455; **Mobiletron:** AB-EU432

APPLICATION / APLICACIÓN:

MERCEDES-BENZ: A-Class A 150 2004>0, A-Class A 160 2009>0, A-Class A 160 Cdi 2004>0, A-Class A 170 2004>0, A-Class A 180 2009>0, A-Class A 180 Cdi 2004>0, A-Class A 200 2004>0, A-Class A 200 Cdi 2004>0, A-Class A 200 Turbo 2005>0, A-Class E-Cell 2010>0, B-Class B 150 2005>0, B-Class B 160 2009>0, B-Class B 170 2005>0, B-Class B 170 Ngt 2008>0, B-Class B 180 2009>0, B-Class B 180 Cdi 2005>0, B-Class B 180 Ngt 2008>0, B-Class B 200 2005>0, B-Class B 200 Cdi 2005>0, B-Class F-Cell 2010>0

GS2417 // NEW //
FRONT WHEEL SENSOR (BOTH SIDES)
REPLACES / REEMPLAZA:
Mercedes-Benz: 2465402510, A2465402510; **Meat & Doria:** 90542; **Mobiletron:** AB-EU250

APPLICATION / APLICACIÓN:

MERCEDES-BENZ: A-Class A 160 2015>0, A-Class A 160 Cdi / D 2013>0, A-Class A 180 2012>0, A-Class A 180 Cdi 2012>0, A-Class A 180 Cdi / D 2012>0, A-Class A 200 2012>0, A-Class A 200 Cdi 2012>0, A-Class A 200 Cdi / D 2014>0, A-Class A 200 Cdi / D 4-Matic 2014>0, A-Class A 220 4-Matic 2014>0, A-Class A 220 Cdi 2012>0, A-Class A 220 Cdi 4-Matic 2014>0, A-Class A 220 D 2015>0, A-Class A 220 D 4-Matic 2015>0, A-Class A 250 2012>0, A-Class A 250 2015>0, A-Class A 250 4-Matic 2013>0, A-Class A 250 4-Matic 2015>0, A-Class A 45 Amg 4-Matic 2013>0, A-Class Amg A 45 4-Matic 2015>0, B-Class B 160 Cdi / D 2013>0, B-Class B 180 2011>0, B-Class B 180 Cdi 2011>0, B-Class B 180 Cdi / D 2013>0, B-Class B 200 2011>0, B-Class B 200 Cdi 2011>0, B-Class B 200 Cdi / D 2014>0, B-Class B 200 Cdi / D 4-Matic 2014>0, B-Class B 200 Natural Gas Drive / B 200 C 2012>0, B-Class B 220 4-Matic 2013>0, B-Class B 220 Cdi / D 2011>0, B-Class B 220 Cdi / D 4-Matic 2014>0, B-Class B 250 2012>0, B-Class B 250 4-Matic 2014>0, B-Class Electric Drive / B 250 E 2014>0, Cla Coupe Amg Cla 45 4-Matic 2015>0, Cla Coupe Cla 180 2013>0, Cla Coupe Cla 180 Cdi / D 2013>0, Cla Coupe Cla 200 2013>0, Cla Coupe Cla 200 Cdi 2013>0, Cla Coupe Cla 200 Cdi / D 2014>0, Cla Coupe Cla 200 Cdi / D 4-Matic 2014>0, Cla Coupe Cla 220 Cdi / D 2013>0, Cla Coupe Cla 220 Cdi / D 4-Matic 2014>0, Cla Coupe Cla 220 Cdi 4-Matic 2014>0, Cla Coupe Cla 250 2013>0, Cla Coupe Cla 250 2015>0, Cla Coupe Cla 250 4-Matic 2013>0, Cla Coupe Cla 250 4-Matic 2015>0, Cla Shooting Brake Amg Cla 45 4-Matic 2015>0, Cla Shooting Brake Cla 180 2015>0, Cla Shooting Brake Cla 180 D 2015>0, Cla Shooting Brake Cla 200 2015>0, Cla Shooting Brake Cla 200 Cdi / D 2015>0, Cla Shooting Brake Cla 200 Cdi / D 4-Matic 2015>0, Cla Shooting Brake Cla 220 Cdi / D 2015>0, Cla Shooting Brake Cla 220 Cdi / D 4-Matic 2015>0, Cla Shooting Brake Cla 250 2015>0, Cla Shooting Brake Cla 250 4-Matic 2015>0, Cla Shooting Brake Cla 45 Amg 4-Matic 2015>0, Gla-Class Amg Gla 45 4-Matic 2015>0, Gla-Class Gla 180 2015>0, Gla-Class Gla 180 Cdi / D 2014>0, Gla-Class Gla 200 2013>0, Gla-Class Gla 200 Cdi / D 2013>0, Gla-Class Gla 200 Cdi 4-Matic 2013>0, Gla-Class Gla 220 Cdi 2013>0, Gla-Class Gla 220 Cdi / D 2013>0, Gla-Class Gla 220 Cdi / D 4-Matic 2013>0, Gla-Class Gla 220 Cdi 4-Matic 2013>0, Gla-Class Gla 220 D 2015>0, Gla-Class Gla 220 D 4-Matic 2015>0, Gla-Class Gla 250 2013>0, Gla-Class Gla 250 4-Matic 2013>0, Gla-Class Gla 45 Amg 4-Matic 2014>0

GS2418 // NEW //
REAR WHEEL SENSOR (BOTH SIDES)
REPLACES / REEMPLAZA:
Mercedes-Benz: 2465400417, A2465400417, A2469059402; **A.B.S.:** 31457; **Meat & Doria:** 31457; **Mobiletron:** B-EU473

APPLICATION / APLICACIÓN:
FORD: Transit Box 2.0 Di 2000>0, Transit Box 2.0 Tdci 2002>0, Transit Box 2.3 16V Rwd 2001>0, Transit Box 2.3 Bifuel 2001>0, Transit Box 2.4 Di 2000>0, Transit Box 2.4 Di Rwd 2000>0, Transit Box 2.4 Tdci 2004>0, Transit Box 2.3 16V Rwd 2000>0, Transit Box 2.4 Tde 2001>0, Transit Bus 2.0 Di 2000>0, Transit Bus 2.0 Tdci 2002>0, Transit Bus 2.2 Tdci 2006>0, Transit Bus 2.2 Tdci Rwd 2011>0, Transit Bus 2.3 16V Rwd 2000>0, Transit Bus 2.4 Di 2000>0, Transit Bus 2.4 Di Rwd 2000>0, Transit Bus 2.4 Tdci 2004>0, Transit Bus 2.4 Tdci 4X4 2006>0, Transit Bus 2.4 Tde 2001>0, Transit Bus 3.2 Tdci 2008>0, Transit Platform/Chassis 2.0 Di 2000>0, Transit Platform/Chassis 2.0 Tdci 2002>0, Transit Platform/Chassis 2.3 16V 2001>0, Transit Platform/Chassis 2.4 Di 2000>0, Transit Platform/Chassis 2.4 Tdci 2004>0, Transit Platform/Chassis 2.4 Tde 2001>0

GS2419 // NEW //
REAR WHEEL SENSOR (BOTH SIDES)
REPLACES / REEMPLAZA:
Mini Cooper: 3452679320, 34526851501, 0265007808

APPLICATION / APLICACIÓN:
MINI: Mini Cooper 2006>0, Mini Cooper D 2006>0, Mini Cooper S 2006>0, Mini Cooper S John Cooper Works 2006>0, Mini Cooper Sd 2009>0, Mini John Cooper Works 2007>0, Mini John Cooper Works Gp 2012>0, Mini One 2006>0, Mini One D 2009>0, Mini One Lpg 2009>0, Mini Clubman Cooper 2006>0, Mini Clubman Cooper D 2006>0, Mini Clubman Cooper S 2006>0, Mini Clubman Cooper S John Cooper Works 2006>0, Mini Clubman Cooper Sd 2009>0, Mini Clubman John Cooper Works 2007>0, Mini Clubman One 2006>0, Mini Clubman One D 2009>0, Mini Clubvan Cooper 2006>0, Mini Clubvan Cooper D 2006>0, Mini Clubvan One 2006>0, Mini Convertible Cooper 2006>0, Mini Convertible Cooper D 2006>0, Mini Convertible Cooper S 2006>0, Mini Convertible Cooper Sd 2009>0, Mini Convertible John Cooper Works 2007>0, Mini Convertible One 2006>0, Mini Coupe Cooper 2006>0, Mini Coupe Cooper S 2006>0, Mini Coupe Cooper S Jcw 2010>0, Mini Coupe Cooper Sd 2009>0, Mini Coupe John Cooper Works 2007>0, Mini Roadster Cooper 2006>0, Mini Roadster Cooper S 2006>0, Mini Roadster Cooper S Jcw 2010>0, Mini Roadster Cooper Sd 2009>0, Mini Roadster John Cooper Works 2007>0

GS2420 // NEW //
FRONT WHEEL SENSOR (BOTH SIDES)
REPLACES / REEMPLAZA:
Mini Cooper: 34526793819, 345268515000, 0265007807; **Bosch:** 0 265 007 807

APPLICATION / APLICACIÓN:
MINI: Mini Cooper 2006>0, Mini Cooper D 2006>0, Mini Cooper S 2006>0, Mini Cooper S John Cooper Works 2006>0, Mini Cooper Sd 2009>0, Mini John Cooper Works 2007>0, Mini John Cooper Works Gp 2012>0, Mini One 2006>0, Mini One D 2009>0, Mini One Lpg 2009>0, Mini Clubman Cooper 2006>0, Mini Clubman Cooper D 2006>0, Mini Clubman Cooper S 2006>0, Mini Clubman Cooper S John Cooper Works 2006>0, Mini Clubman Cooper Sd 2009>0, Mini Clubman John Cooper Works 2007>0, Mini Clubman One 2006>0, Mini Clubman One D 2009>0, Mini Clubvan Cooper 2006>0, Mini Clubvan Cooper D 2006>0, Mini Clubvan One 2006>0, Mini Convertible Cooper 2006>0, Mini Convertible Cooper D 2006>0, Mini Convertible Cooper S 2006>0, Mini Convertible Cooper Sd 2009>0, Mini Convertible John Cooper Works 2007>0, Mini Convertible One 2006>0, Mini Coupe Cooper 2006>0, Mini Coupe Cooper S 2006>0, Mini Coupe Cooper S Jcw 2010>0, Mini Coupe Cooper Sd 2009>0, Mini Coupe John Cooper Works 2007>0, Mini Roadster Cooper 2006>0, Mini Roadster Cooper S 2006>0, Mini Roadster Cooper S Jcw 2010>0, Mini Roadster Cooper Sd 2009>0, Mini Roadster John Cooper Works 2007>0

GS2421 // NEW //
REAR WHEEL SENSOR (BOTH SIDES)
REPLACES / REEMPLAZA:
Mini Cooper: 34529804590, 34529809194; **Bosch:** 0 265 008 525; **A.B.S.:** 31202

APPLICATION / APLICACIÓN:
MINI: Mini Countryman Cooper 2010>0, Mini Countryman Cooper All4 2012>0, Mini Countryman Cooper D 2010>0, Mini Countryman Cooper D All4 2010>0, Mini Countryman Cooper S 2010>0, Mini Countryman Cooper S All4 2010>0, Mini Countryman Cooper Sd 2011>0, Mini Countryman Cooper Sd All4 2011>0, Mini Countryman John Cooper Works All4 2012>0, Mini Countryman One 2010>0, Mini Countryman One D 2010>0, Mini Paceman Cooper 2010>0, Mini Paceman Cooper All4 2012>0, Mini Paceman Cooper D 2010>0, Mini Paceman Cooper D All4 2010>0, Mini Paceman Cooper S 2010>0, Mini Paceman Cooper S All4 2010>0, Mini Paceman Cooper Sd 2011>0, Mini Paceman Cooper Sd All4 2011>0, Mini Paceman John Cooper Works 2013>0

GS2422 // NEW //
FRONT WHEEL SENSOR (BOTH SIDES)
REPLACES / REEMPLAZA:
Mini Cooper: 34529804589, 34529808193; **Bosch:** 0 265 008 526; **Delphi:** SS20557; **A.B.S.:** 31201

APPLICATION / APLICACIÓN:
MINI: Mini Countryman Cooper 2010>0, Mini Countryman Cooper All4 2012>0, Mini Countryman Cooper D 2010>0, Mini Countryman Cooper D All4 2010>0, Mini Countryman Cooper S 2010>0, Mini Countryman Cooper S All4 2010>0, Mini Countryman Cooper Sd 2011>0, Mini Countryman Cooper Sd All4 2011>0, Mini Countryman John Cooper Works All4 2012>0, Mini Countryman One 2010>0, Mini Countryman One D 2010>0, Mini Paceman Cooper 2010>0, Mini Paceman Cooper All4 2012>0, Mini Paceman Cooper D 2010>0, Mini Paceman Cooper D All4 2010>0, Mini Paceman Cooper S 2010>0, Mini Paceman Cooper S All4 2010>0, Mini Paceman Cooper Sd 2011>0, Mini Paceman Cooper Sd All4 2011>0, Mini Paceman John Cooper Works 2013>0

GS2425 // NEW //
REAR WHEEL SENSOR (LEFT SIDE)
REPLACES / REEMPLAZA:
Nissan: 479009Z700, 479009Z710

APPLICATION / APLICACIÓN:
NISSAN: Frontier 1999>2006, Xterra 2001>2005

GS2426 // NEW //
FRONT WHEEL SENSOR (BOTH SIDES)
REPLACES / REEMPLAZA:
Mini Cooper: 34526756384, 0986594586; **Bosch:** 0 986

594 536; Delphi: SS20123; **Cargo:** 181899;

Meat & Doria: 90081; **Mobiletron:** AB-EU016

APPLICATION / APLICACIÓN:
MINI: Mini Cooper 2001>0, Mini Cooper S 2002>0, Mini John Cooper Works 2004>0, Mini One 2001>0, Mini One D 2003>0, Mini S Works 2003>0, Mini Works 2003>0, Mini Convertible Cooper 2001>0, Mini Convertible Cooper S 2002>0, Mini Convertible John Cooper Works 2004>0, Mini Convertible One 2001>0



GS2427 // NEW //

REAR WHEEL SENSOR (BOTH SIDES)

REPLACES / REEMPLAZA:

Mini Cooper: 34526756385, 0986594537; **Bosch:** 0 986 594 537; **Cargo:** 181900; **Meat & Doria:** 90082; **Mobiletron:** AB-EU195

APPLICATION / APLICACIÓN:

MINI: Mini Cooper 2001>0, Mini Cooper S 2002>0, Mini John Cooper Works 2004>0, Mini One 2001>0, Mini One D 2003>0, Mini S Works 2003>0, Mini Works 2003>0, Mini Convertible Cooper 2001>0, Mini Convertible Cooper S 2002>0, Mini Convertible John Cooper Works 2004>0, Mini Convertible One 2001>0



GS2428 // NEW //

REAR WHEEL SENSOR (LEFT SIDE)

REPLACES / REEMPLAZA:

Mitsubishi: 4670A157, 4670A583; **A.B.S.:** 31122; **Meat & Doria:** 90526, 90526

APPLICATION / APLICACIÓN:

MITSUBISHI: Lancer Viii 1.5 2008>0, Lancer Viii 1.5 Bifuel 2010>0, Lancer Viii 1.6 Mivec 2010>0, Lancer Viii 1.8 2008>0, Lancer Viii 1.8 Bifuel 2010>0, Lancer Viii 1.8 Di-D 2010>0, Lancer Viii 1.8 Flexfuel 2009>0, Lancer Viii 2.0 2009>0, Lancer Viii 2.0 Di-D 2007>0, Lancer Viii 2.0 I Ralliart 4Wd 2008>0, Lancer Viii Sportback 2.0 Ralliart 4Wd 2008>0, Outlander li 2.0 Di-D 2007>0, Outlander li 2.2 Di-D 2006>0, Outlander li 2.2 Di-D 4Wd 2006>0, Outlander li 2.4 2006>0, Outlander li 2.4 4Wd 2007>0, Outlander li 2.4 Flex 4Wd 2007>0, Outlander li 3.0 4Wd 2006>0, Pajero Classic 3.2 Did 2006>0, Pajero Iv 3.0 4Wd 2007>0, Pajero Iv 3.2 Di-D 2007>0, Pajero Iv 3.2 Di-D 4Wd 2008>0, Pajero Iv 3.2 Di-D 4Wd 2007>0, Pajero Iv 3.8 V6 2006>0, Pajero Iv 3.8 V6 2007>0, Pajero Iv Van 3.2 Di-D 2006>0, Pajero Iv Van 3.2 Td 4Wd 2010>0



GS2429 // NEW //

REAR WHEEL SENSOR (RIGHT SIDE)

REPLACES / REEMPLAZA:

Mitsubishi: 4670A158, 4670A584; **A.B.S.:** 31123; **Meat & Doria:** 90527

APPLICATION / APLICACIÓN:

MITSUBISHI: Lancer Viii 1.5 2008>0, Lancer Viii 1.5 Bifuel 2010>0, Lancer Viii 1.6 Mivec 2010>0, Lancer Viii 1.8 2008>0, Lancer Viii 1.8 Bifuel 2010>0, Lancer Viii 1.8 Di-D 2010>0, Lancer Viii 1.8 Flexfuel 2009>0, Lancer Viii 2.0 2009>0, Lancer Viii 2.0 Di-D 2007>0, Lancer Viii 2.0 I Ralliart 4Wd 2008>0, Lancer Viii Sportback 2.0 Ralliart 4Wd 2008>0, Outlander li 2.0 Di-D 2007>0, Outlander li 2.2 Di-D 2006>0, Outlander li 2.2 Di-D 4Wd 2006>0, Outlander li 2.4 2006>0, Outlander li 2.4 4Wd 2007>0, Outlander li 2.4 Flex 4Wd 2007>0, Outlander li 3.0 4Wd 2006>0, Pajero Classic 3.2 Did 2006>0, Pajero Iv 3.0 4Wd 2007>0, Pajero Iv 3.2 Di-D 2007>0, Pajero Iv 3.2 Di-D 4Wd 2008>0, Pajero Iv 3.2 Di-D 4Wd 2007>0, Pajero Iv 3.8 V6 2006>0, Pajero Iv 3.8 V6 2007>0, Pajero Iv Van 3.2 Di-D 2006>0, Pajero Iv Van 3.2 Td 4Wd 2010>0



GS2430 // NEW //

FRONT WHEEL SENSOR (LEFT SIDE)

REPLACES / REEMPLAZA:

Mitsubishi: MR307038; **A.B.S.:** 30963

APPLICATION / APLICACIÓN:

MITSUBISHI: Galloper 2.5 Td 1998>0, Galloper 2.5 Td Intercooler 1998>0, Pajero Sport I 2.5 Td 1998>0, Pajero Sport I 2.5 Td 2002>0, Pajero Sport I 3.0 V6 1998>0, Pajero Sport I 3.0 V6 4Wd 2003>0, Pajero Sport Van I 2.5 Td 1998>0, Pajero Sport Van I 3.0 V6 1999>0



GS2431 // NEW //

FRONT WHEEL SENSOR (RIGHT SIDE)

REPLACES / REEMPLAZA:

Mitsubishi: MR307039; **A.B.S.:** 30964

APPLICATION / APLICACIÓN:

MITSUBISHI: Galloper 2.5 Td 1998>0, Galloper 2.5 Td Intercooler 1998>0, Pajero Sport I 2.5 Td 1998>0, Pajero Sport I 2.5 Td 2002>0, Pajero Sport I 3.0 V6 1998>0, Pajero Sport I 3.0 V6 4Wd 2003>0, Pajero Sport Van I 2.5 Td 1998>0, Pajero Sport Van I 3.0 V6 1999>0



GS2433 // NEW //

REAR WHEEL SENSOR (LEFT SIDE)

REPLACES / REEMPLAZA:

Mitsubishi: MR407270; **A.B.S.:** 31141; **Meat & Doria:** 90340; **Mobiletron:** AB-JP118

APPLICATION / APLICACIÓN:

MITSUBISHI: Pajero Classic 2.5 Td 2001>0, Pajero Iii Canvas Top 2.5 Tdi 2001>0, Pajero Iii Canvas Top 3.2 Di-D 2000>0



GS2434 // NEW //

REAR WHEEL SENSOR (RIGHT SIDE)

REPLACES / REEMPLAZA:

Mitsubishi: MR407271, 4670A256; **A.B.S.:** 31728

APPLICATION / APLICACIÓN:

MITSUBISHI: Pajero Iv 3.0 4Wd 2007>0, Pajero Iv 3.2 Di-D 2007>0, Pajero Iv 3.2 Di-D 4Wd 2007>0, Pajero Iv 3.8 V6 2006>0, Pajero Iv Van 3.2 Di-D 2006>0, Pajero Iv Van 3.2 Di-D 4Wd 2007>0, Pajero Iv Van 3.2 Td 4Wd 2010>0



GS2435 // NEW //

FRONT WHEEL SENSOR (LEFT SIDE)

REPLACES / REEMPLAZA:

Mitsubishi: MR569411, MR407268; **A.B.S.:** 31139; **Meat & Doria:** 90333; **Mobiletron:** AB-JP072

APPLICATION / APLICACIÓN:

MITSUBISHI: Pajero Classic 2.5 Td 2001>0, Pajero Iii Canvas Top 2.5 Tdi 2001>0, Pajero Iii Canvas Top 3.2 Di-D 2000>0



GS2436 // NEW //

FRONT WHEEL SENSOR (RIGHT SIDE)

REPLACES / REEMPLAZA:

Mitsubishi: MR569412, MR407269; **A.B.S.:** 31140; **Meat & Doria:** 90334; **Mobiletron:** AB-JP073

APPLICATION / APLICACIÓN:

MITSUBISHI: Pajero Classic 2.5 Td 2001>0, Pajero Iii Canvas Top 2.5 Tdi 2001>0, Pajero Iii Canvas Top 3.2 Di-D 2000>0



GS2437 // NEW //

REAR WHEEL SENSOR (BOTH SIDES)

REPLACES / REEMPLAZA:

Mitsubishi: MR569090, MR475175; **A.B.S.:** 31182; **Meat & Doria:** 90827E

APPLICATION / APLICACIÓN:

MITSUBISHI: Pajero Pinin 1.8 2001>0, Pajero Pinin 1.8 Gdi 1999>0, Pajero Pinin 2.0 Gdi 2000>0

GS2438 // NEW //
FRONT WHEEL SENSOR (LEFT SIDE)
REPLACES / REEMPLAZA:
Mitsubishi: MR370777; **A.B.S.:** 31057; **Meat & Doria:** 90825E

APPLICATION / APLICACIÓN:
MITSUBISHI: Pajero Pinin 1.8 2001>0, Pajero Pinin 1.8 Gdi 1999>0, Pajero Pinin 2.0 Gdi 2000>0

GS2439 // NEW //
FRONT WHEEL SENSOR (RIGHT SIDE)
REPLACES / REEMPLAZA:
Mitsubishi: MR370778, MR977447; **A.B.S.:** 31058; **Meat & Doria:** 90826E

APPLICATION / APLICACIÓN:
MITSUBISHI: Pajero Pinin 1.8 2001>0, Pajero Pinin 1.8 Gdi 1999>0, Pajero Pinin 2.0 Gdi 2000>0

GS2440 // NEW //
FRONT WHEEL SENSOR (BOTH SIDES)
REPLACES / REEMPLAZA:
GM: 94544440, 95490814; **Opel:** 01247465, 01249066, 09454444, 094544440, 09549081, 095490814, 1247465, 1249066, 94544440, 95490814; **Meat & Doria:** 90887

APPLICATION / APLICACIÓN:
GM: TRAX 1.4, 1.6, 1.8 2012>2013;

OPEL: MOKKA / MOKKA X (J13) 1.4, 1.6, 1.7, 1.8 2012>2015

PS: set of GS2443 and GS2444

GS2441 // NEW //
REAR WHEEL SENSOR (BOTH SIDES)
REPLACES / REEMPLAZA:
Nissan: 479003TA1A

APPLICATION / APLICACIÓN:
NISSAN: Altima 2013>2017

GS2442 // NEW //
FRONT WHEEL SENSOR (BOTH SIDES)
REPLACES / REEMPLAZA:
Nissan: 479103TA1A, 479103TA2A

APPLICATION / APLICACIÓN:
NISSAN: Altima 2013>2017

GS2443 // NEW //
REAR WHEEL SENSOR (LEFT SIDE)
REPLACES / REEMPLAZA:
GM: 94544443, 95371618, 95292704, 95328629, 95075982;

Opel: 1247688, 095075982, 01247704, 095292704, 095328629; **Meat & Doria:** 90888

APPLICATION / APLICACIÓN:
GM: TRAX 1.4, 1.6, 1.8 2012>2013;

OPEL: MOKKA / MOKKA X (J13) 1.4, 1.6, 1.7, 1.8 2012>2015

PS: set of GS2440 and GS2444

GS2444 // NEW //
REAR WHEEL SENSOR (RIGHT SIDE)
REPLACES / REEMPLAZA:
GM: 94544444, 95371619, 95328630, 95292705, 95075978;

Opel: 95075978, 95292705, 01247689, 095328630;

Meat & Doria: 90889

APPLICATION / APLICACIÓN:
GM: TRAX 1.4, 1.6, 1.8 2012>2013;

OPEL: MOKKA / MOKKA X (J13) 1.4, 1.6, 1.7, 1.8 2012>2015

PS: set of GS2440 and GS2443

GS2446 // NEW //
FRONT WHEEL SENSOR (BOTH SIDES)
REPLACES / REEMPLAZA:
Nissan: 47910EA025, 5621082Z00; **Meat & Doria:** 90755

APPLICATION / APLICACIÓN:
NISSAN: Np300 Navara 2.5 Dci 2005>0, Np300 Navara 2.5 Dci 4Wd 2005>0, Np300 Navara 2.5 Dci 4Wd 2009>0, Np300 Navara Platparam/Chassis 2.5 Dci 2005>0, Np300 Navara Platparam/Chassis 2.5 Dci 4Wd 2005>0, Pathfinder Iii 2.5 Dci 2005>0, Pathfinder Iii 2.5 Dci 4Wd 2005>0, Pathfinder Iii 4.0 4Wd 2005>0

GS2447 // NEW //
REAR WHEEL SENSOR (RIGHT SIDE)
REPLACES / REEMPLAZA:
Nissan: 479009CA5A, 47900EA005;

Meat & Doria: 90757E

APPLICATION / APLICACIÓN:
NISSAN: Np300 Navara 2.5 Dci 2005>0, Np300 Navara 2.5 Dci 4Wd 2005>0, Np300 Navara 2.5 Dci 4Wd 2009>0, Np300 Navara 3.0 Dci 4Wd 2010>0, Np300 Navara Platform/Chassis 2.5 Dci 2005>0, Np300 Navara Platform/Chassis 2.5 Dci 4Wd 2005>0, Np300 Navara Platform/Chassis 3.0 Dci 2010>0

GS2448 // NEW //
FRONT WHEEL SENSOR (RIGHT SIDE)
REPLACES / REEMPLAZA:
GM: 94544448, 95019935; **Delphi:** SS20360

APPLICATION / APLICACIÓN:
GM: Aveo Hatchback (T300) 1.2, 1.2 LGP, 1.3 D, 1.4, 1.6 2011>, Aveo Saloon (T300) 1.2, 1.2 LGP, 1.3 D, 1.4, 1.6 2011>

GS2449 // NEW //
FRONT WHEEL SENSOR (LEFT SIDE)
REPLACES / REEMPLAZA:
GM: 94544449, 96852905; **Delphi:** SS20363

APPLICATION / APLICACIÓN:
GM: Aveo Hatchback (T300) 1.2, 1.2 LGP, 1.3 D, 1.4, 1.6 2011>, Aveo Saloon (T300) 1.2, 1.2 LGP, 1.3 D, 1.4, 1.6 2011>

PS: set of GS2448, GS2450 and GS2451

GS2450 // NEW //
REAR WHEEL SENSOR (LEFT SIDE)
REPLACES / REEMPLAZA:
GM: 94544450, 95164925; **Delphi:** SS20361

APPLICATION / APLICACIÓN:
GM: Aveo Hatchback (T300) 1.2, 1.2 LGP, 1.3 D, 1.4, 1.6 2011>, Aveo Saloon (T300) 1.2, 1.2 LGP, 1.3 D, 1.4, 1.6 2011>

PS: set of GS2448, GS2449 and GS2451

GS2451 // NEW //
REAR WHEEL SENSOR (RIGHT SIDE)

REPLACES / REEMPLAZA:

GM: 94544451, 95164926; **Delphi:** SS20362

APPLICATION / APLICACIÓN:

GM: Aveo Hatchback (T300) 1.2, 1.2 LGP, 1.3 D, 1.4, 1.6 2011>; Aveo Saloon (T300) 1.2, 1.2 LGP, 1.3 D, 1.4, 1.6 2011>

PS: set of GS2448, GS2449 and GS2450

GS2452 // NEW //
REAR WHEEL SENSOR (RIGHT SIDE)

REPLACES / REEMPLAZA:

Mitsubishi: MR493458, MR493460; **A.B.S.:** 31171;

Meat & Doria: 90339

APPLICATION / APLICACIÓN:

MITSUBISHI: Outlander I 2.0 2003>0, Outlander I 2.0 4Wd 2003>0, Outlander I 2.0 Turbo 4Wd 2004>0, Outlander I 2.4 4Wd 2003>0

GS2453 // NEW //
REAR WHEEL SENSOR (LEFT SIDE)

REPLACES / REEMPLAZA:

Mitsubishi: MR493457, MR493459; **A.B.S.:** 31180;

Meat & Doria: 90338

APPLICATION / APLICACIÓN:

MITSUBISHI: Outlander I 2.0 2003>0, Outlander I 2.0 4Wd 2003>0, Outlander I 2.0 Turbo 4Wd 2004>0, Outlander I 2.4 4Wd 2003>0

GS2454 // NEW //
FRONT WHEEL SENSOR (LEFT SIDE)

REPLACES / REEMPLAZA:

Mitsubishi: MR527311; **A.B.S.:** 31119

APPLICATION / APLICACIÓN:

MITSUBISHI: Lancer Cargo Box Body/Estate 1.6 2003>0, Lancer Cargo Box Body/Estate 2.0 2003>0, Lancer Vii 1.3 2003>0, Lancer Vii 1.6 2003>0, Lancer Vii 2.0 2003>0, Lancer Vii Estate 1.6 2003>0, Lancer Vii Estate 2.0 2003>0

GS2455 // NEW //
FRONT WHEEL SENSOR (RIGHT SIDE)

REPLACES / REEMPLAZA:

Mitsubishi: MR527312; **A.B.S.:** 30973

APPLICATION / APLICACIÓN:

MITSUBISHI: Lancer Cargo Box Body/Estate 1.6 2003>0, Lancer Cargo Box Body/Estate 2.0 2003>0, Lancer Vii 1.3 2003>0, Lancer Vii 1.6 2003>0, Lancer Vii 2.0 2003>0, Lancer Vii Estate 1.6 2003>0, Lancer Vii Estate 2.0 2003>0

GS2456 // NEW //
REAR WHEEL SENSOR (RIGHT SIDE)

REPLACES / REEMPLAZA:

Mitsubishi: MR407821; **Delphi:** SS20207; **A.B.S.:** 30974

APPLICATION / APLICACIÓN:

MITSUBISHI: Lancer Cargo Box Body/Estate 1.6 2003>0, Lancer Cargo Box Body/Estate 2.0 2003>0, Lancer V Station Wagon 1.6 16V 1992>0, Lancer Vi 1.3 12V 1995>0, Lancer Vi 1.6 16V 1995>0, Lancer Vii 1.3 2003>0, Lancer Vii 1.6 2003>0, Lancer Vii 2.0 2003>0, Lancer Vii Evo Ix 2005>0, Lancer Vii Evo Viii - 260 2004>0, Lancer Vii Estate 1.6 2003>0, Lancer Vii Estate 2.0 2003>0, Lancer Viii 1.6 Mivec 2010>0, Lancer Viii Evo X - Fq330 2008>0, Lancer Viii Evo X - Fq360 2008>0, Lancer Viii Evo X 2008>0, Lancer Viii Sportback 1.6 Mivec 2010>0, Lancer Viii Sportback 2.0 Ralliart 4Wd 2008>0

GS2457 // NEW //
REAR WHEEL SENSOR (LEFT SIDE)

REPLACES / REEMPLAZA:

Mitsubishi: MR569781; **A.B.S.:** 31179

APPLICATION / APLICACIÓN:

MITSUBISHI: Lancer Cargo Box Body/Estate 1.6 2003>0, Lancer Cargo Box Body/Estate 2.0 2003>0, Lancer Vii 1.3 2003>0, Lancer Vii 1.6 2003>0, Lancer Vii 2.0 2003>0, Lancer Vii Estate 1.6 2003>0, Lancer Vii Estate 2.0 2003>0

GS2460 // NEW //
FRONT WHEEL SENSOR (LEFT SIDE)

REPLACES / REEMPLAZA:

Nissan: 479110L700, F01G09F0EL; **A.B.S.:** 31852

APPLICATION / APLICACIÓN:

NISSAN: Cefiro Ii Saloon 2.0 1994>0, Maxima / Maxima Qx Ii 2.0 1994>0, Maxima / Maxima Qx Ii Station Wagon 2.0 Qx 1997>0

GS2461 // NEW //
FRONT WHEEL SENSOR (RIGHT SIDE)

REPLACES / REEMPLAZA:

Nissan: 479100L700, F01G09F0EM; **A.B.S.:** 31853

APPLICATION / APLICACIÓN:

NISSAN: Cefiro Ii Saloon 2.0 1994>0, Maxima / Maxima Qx Ii 2.0 1994>0, Maxima / Maxima Qx Ii Station Wagon 2.0 Qx 1997>0

GS2462 // NEW //
REAR WHEEL SENSOR (LEFT SIDE)

REPLACES / REEMPLAZA:

Nissan: 479010W060, F01G09F0HF

APPLICATION / APLICACIÓN:

NISSAN: Pathfinder Ii 2.7 Td 4Wd 1997>0, Pathfinder Ii 3.0 Ddti 4Wd 1999>0, Pathfinder Ii 3.2 Td 4Wd 1997>0, Pathfinder Ii 3.3 1999>0, Pathfinder Ii 3.5 2000>0, Pathfinder Ii 3.5 4Wd 2001>0, Pathfinder Ii 3.5 V6 4Wd 2000>0

GS2463 // NEW //
FRONT WHEEL SENSOR (RIGHT SIDE)

REPLACES / REEMPLAZA:

Nissan: 479100W060, F01G09F0H8

APPLICATION / APLICACIÓN:

NISSAN: Pathfinder Ii 2.7 Td 4Wd 1997>0, Pathfinder Ii 3.0 Ddti 4Wd 1999>0, Pathfinder Ii 3.2 Td 4Wd 1997>0, Pathfinder Ii 3.3 1999>0, Pathfinder Ii 3.3 V6 4Wd 1997>0, Pathfinder Ii 3.5 2000>0, Pathfinder Ii 3.5 4Wd 2001>0, Pathfinder Ii 3.5 V6 4Wd 2000>0

GS2464 // NEW //
FRONT WHEEL SENSOR (LEFT SIDE)

REPLACES / REEMPLAZA:

Nissan: 479110W060

APPLICATION / APLICACIÓN:

NISSAN: Pathfinder Ii 2.7 Td 4Wd 1997>0, Pathfinder Ii 3.0 Ddti 4Wd 1999>0, Pathfinder Ii 3.2 Td 4Wd 1997>0, Pathfinder Ii 3.3 1999>0, Pathfinder Ii 3.3 V6 4Wd 1997>0, Pathfinder Ii 3.5 2000>0, Pathfinder Ii 3.5 4Wd 2001>0, Pathfinder Ii 3.5 V6 4Wd 2000>0

GS2465 // NEW //

REAR WHEEL SENSOR (RIGHT SIDE)

REPLACES / REEMPLAZA:
Nissan: 479003JA0A, 479003JA0B
 APPLICATION / APLICACIÓN:
NISSAN: Pathfinder 2013>2017

GS2466 // NEW //

REAR WHEEL SENSOR (LEFT SIDE)

REPLACES / REEMPLAZA:
Nissan: 479013JA0A, 479013JA0B
 APPLICATION / APLICACIÓN:
NISSAN: Pathfinder 2013>2017

GS2468 // NEW //

REAR WHEEL SENSOR (LEFT SIDE)

REPLACES / REEMPLAZA:
Nissan: 47901EL00A; **A.B.S.:** 31796;
Meat & Doria: 90918E
 APPLICATION / APLICACIÓN:
NISSAN: Tiida Hatchback 1.5 2004>0, Tiida Hatchback 1.5 Dci 2007>0, Tiida Hatchback 1.6 2007>0, Tiida Hatchback 1.8 2007>0, Tiida Saloon 1.5 Dci 2007>0, Tiida Saloon 1.6 2007>0, Tiida Saloon 1.8 2007>0

GS2469 // NEW //

FRONT WHEEL SENSOR (BOTH SIDES)

REPLACES / REEMPLAZA:
Nissan: 47901EL00A, 47901ZR70A; **A.B.S.:** 31795;
Meat & Doria: 90917E
 APPLICATION / APLICACIÓN:
NISSAN: Tiida Hatchback 1.5 2004>0, Tiida Hatchback 1.5 Dci 2007>0, Tiida Hatchback 1.6 2007>0, Tiida Hatchback 1.8 2007>0, Tiida Saloon 1.5 Dci 2007>0, Tiida Saloon 1.6 2007>0, Tiida Saloon 1.8 2007>0

GS2473 // NEW //

REAR WHEEL SENSOR (RIGHT SIDE)

REPLACES / REEMPLAZA:
Nissan: 479001HA0A; **A.B.S.:** 31359;
Meat & Doria: 90546
 APPLICATION / APLICACIÓN:
NISSAN: Micra Iv 1.2 2010>0, Micra Iv 1.2 Dig-S 2011>0, Micra Iv 1.5 2011>0, Note 1.2 2010>0, Note 1.2 Dig-S 2011>0, Note 1.5 Dci 2013>0

GS2474 // NEW //

REAR WHEEL SENSOR (LEFT SIDE)

REPLACES / REEMPLAZA:
Nissan: 479011HA0A; **A.B.S.:** 31358;
Meat & Doria: 90545
 APPLICATION / APLICACIÓN:
NISSAN: Micra Iv 1.2 2010>0, Micra Iv 1.2 Dig-S 2011>0, Micra Iv 1.5 2011>0, Note 1.2 2010>0, Note 1.2 Dig-S 2011>0, Note 1.5 Dci 2013>0

GS2475 // NEW //

FRONT WHEEL SENSOR (BOTH SIDES)

REPLACES / REEMPLAZA:
Nissan: 479103DA0A; **A.B.S.:** 31374; **Meat & Doria:** 90914E; **Mobiletron:** AB-JP111
 APPLICATION / APLICACIÓN:
NISSAN: Pulsar Hatchback 1.2 Dig-T 2014>0, Pulsar Hatchback 1.5 Dci 2007>0, Pulsar Hatchback 1.6 Dig-T 2015>0, Tiida Hatchback 1.6 2007>0, Tiida Hatchback 1.8 2007>0, Tiida Saloon 1.5 Dci 2007>0, Tiida Saloon 1.6 2007>0, Tiida Saloon 1.8 2007>0

GS2476 // NEW //

REAR WHEEL SENSOR (LEFT SIDE)

REPLACES / REEMPLAZA:
Nissan: 479013DA0A; **A.B.S.:** 31375;
Meat & Doria: 90915E; **Mobiletron:** AB-JP112
 APPLICATION / APLICACIÓN:
NISSAN: Pulsar Hatchback 1.2 Dig-T 2014>0, Pulsar Hatchback 1.5 Dci 2007>0, Pulsar Hatchback 1.6 Dig-T 2015>0, Tiida Hatchback 1.6 2007>0, Tiida Hatchback 1.8 2007>0, Tiida Saloon 1.5 Dci 2007>0, Tiida Saloon 1.6 2007>0, Tiida Saloon 1.8 2007>0

GS2477 // NEW //

REAR WHEEL SENSOR (RIGHT SIDE)

REPLACES / REEMPLAZA:
Nissan: 479003DA0A; **A.B.S.:** 31376;
Meat & Doria: 90916, 90916E
 APPLICATION / APLICACIÓN:
NISSAN: Pulsar Hatchback 1.2 Dig-T 2014>0, Pulsar Hatchback 1.5 Dci 2007>0, Pulsar Hatchback 1.6 Dig-T 2015>0, Tiida Hatchback 1.6 2007>0, Tiida Hatchback 1.8 2007>0, Tiida Saloon 1.5 Dci 2007>0, Tiida Saloon 1.6 2007>0, Tiida Saloon 1.8 2007>0

GS2480

FRONT WHEEL SENSOR

REPLACES / REEMPLAZA:
Chevrolet: 15997039, 19303767
GMC: 15997039, 19303767
 APPLICATION / APLICACIÓN:
Chevrolet: Blazer, S10
GMC: Jimmy, Sonoma

GS2481 // NEW //

FRONT WHEEL SENSOR (RIGHT SIDE)

REPLACES / REEMPLAZA:
Nissan: 479100W000; **A.B.S.:** 30997
 APPLICATION / APLICACIÓN:
NISSAN: Pathfinder Ii 3.3 V6 4Wd 1997>0

GS2482 // NEW //

REAR WHEEL SENSOR (LEFT SIDE)

REPLACES / REEMPLAZA:
Nissan: 479110W000; **A.B.S.:** 30996
 APPLICATION / APLICACIÓN:
NISSAN: Pathfinder Ii 3.3 V6 4Wd 1997>0

GS2483 // NEW //
REAR WHEEL SENSOR (RIGHT SIDE)

REPLACES / REEMPLAZA:

Nissan: 479000W000, 479000W005; **A.B.S.:** 31492

APPLICATION / APLICACIÓN:

NISSAN: Pathfinder li 3.3 V6 4Wd 1997>0

GS2484 // NEW //
REAR WHEEL SENSOR (LEFT SIDE)

REPLACES / REEMPLAZA:

Nissan: 479010W000, 479010W005; **A.B.S.:** 31493

APPLICATION / APLICACIÓN:

NISSAN: Pathfinder li 3.3 V6 4Wd 1997>0

GS2485 // NEW //
FRONT WHEEL SENSOR (BOTH SIDES)

REPLACES / REEMPLAZA:

Nissan: 47910AZ60B

APPLICATION / APLICACIÓN:

NISSAN: Livina 2010>2014, Grand Livina 2010>2014

GS2486 // NEW //
REAR WHEEL SENSOR (RIGHT SIDE)

REPLACES / REEMPLAZA:

Nissan: 479001JY0A

APPLICATION / APLICACIÓN:

NISSAN: Livina 2010>2014, Grand Livina 2010>2014

GS2487 // NEW //
REAR WHEEL SENSOR (LEFT SIDE)

REPLACES / REEMPLAZA:

Nissan: 479011JY0A

APPLICATION / APLICACIÓN:

NISSAN: Livina 2010>2014, Grand Livina 2010>2014

GS2488 // NEW //
FRONT WHEEL SENSOR (BOTH SIDES)

REPLACES / REEMPLAZA:

Renault: 82000443135, 8200346992, 0265007467; **Bosch:** 0 265 007 467; **Delphi:** SS20243; **Cargo:** 182347; **Meat & Doria:** 90188, 90188E, 90188/1; **Mobiletron:** AB-EU045

APPLICATION / APLICACIÓN:

RENAULT: Grand Scénic li 1.5 Dci 2003>0, Grand Scénic li 1.6 2003>0, Grand Scénic li 1.9 Dci 2003>0, Grand Scénic li 1.9 Dci 2004>0, Grand Scénic li 2.0 2003>0, Megane li 1.4 16V 2003>0, Megane li 1.4 16V 2002>0, Megane li 1.5 Dci 2003>0, Megane li 1.5 Dci 2002>0, Megane li 1.6 16V 2002>0, Megane li 1.9 Dci 2002>0, Megane li 2.0 16V 2002>0, Megane li 2.0 16V Turbo 2004>0, Megane li Box Body/Estate 1.5 Dci 2003>0, Megane li Box Body/Estate 1.6 2003>0, Megane li Coupé-Cabriolet 1.6 2003>0, Megane li Coupé-Cabriolet 1.9 Dci 2002>0, Megane li Coupé-Cabriolet 2.0 2003>0, Megane li Coupé-Cabriolet 2.0 16V Turbo 2004>0, Megane li Estate 1.4 2003>0, Megane li Estate 1.5 Dci 2004>0, Megane li Estate 1.5 Dci 2003>0, Megane li Estate 1.6 2003>0, Megane li Estate 1.6 Flex 2006>0, Megane li Estate 1.9 Dci 2002>0, Megane li Estate 2.0 2003>0, Megane li Hatchback Van 1.5 Dci 2003>0, Megane li Saloon 1.4 2003>0, Megane li Saloon 1.5 Dci 2004>0, Megane li Saloon 1.5 Dci 2003>0, Megane li Saloon 1.6 2003>0, Megane li Saloon 1.9 Dci 2002>0, Megane li Saloon 1.9 Dci 2003>0, Megane li Saloon 2.0 2003>0, Scénic li 1.4 2003>0, Scénic li 1.5 Dci 2003>0, Scénic li 1.6 2003>0, Scénic li 1.6 Bifuel 2003>0, Scénic li 1.9 Dci 2002>0, Scénic li 1.9 Dci 2003>0, Scénic li 2.0 2003>0, Scénic li 2.0 16V Turbo 2004>0

GS2489 // NEW //
REAR WHEEL SENSOR (BOTH SIDES)

REPLACES / REEMPLAZA:

Renault: 8200043136, 0265007468; **Bosch:** 0 265 007 468; **Cargo:** 182349; **Meat & Doria:** 90189, 90189E; **Mobiletron:** AB-EU218

APPLICATION / APLICACIÓN:

RENAULT: Grand Scénic li 1.5 Dci 2004>2008, Grand Scénic li 1.6 2004>2006, Grand Scénic li 1.9 Dci 2004>2006, Grand Scénic li 2.0 2004>2009, Grand Scénic li 2.0 Dci 2005>2008, Megane li 1.4 16V 2002>2008, Megane li 1.5 Dci 2002>2008, Megane li 1.6 2005>2008, Megane li 1.6 16V 2002>2008, Megane li 1.9 Dci 2002>2005, Megane li 2.0 16V 2002>2008, Megane li 2.0 16V Turbo 2004>2008, Megane li 2.0 Renault Sport 2004>2009, Megane li 2.0 Dci 2005>2008, Megane li Coupé-Cabriolet 1.6 2003>2009, Megane li Coupé-Cabriolet 1.9 Dci 2003>2007, Megane li Coupé-Cabriolet 2.0 2003>2009, Megane li Coupé-Cabriolet 2.0 16V Turbo 2004>2009, Megane li Coupé-Cabriolet 2.0 Dci 2005>2009, Megane li Grandtour 1.4 2003>2009, Megane li Grandtour 1.5 Dci 2003>2006, Megane li Grandtour 1.6 2003>2009, Megane li Grandtour 1.6 16V 2005>2009, Megane li Grandtour 1.9 Dci 2003>2005, Megane li Grandtour 2.0 2003>2009, Megane li Grandtour 2.0 Dci 2005>2009, Megane li Sedan 1.4 2003>, Megane li Sedan 1.5 Dci 2003>2010, Megane li Sedan 1.6 2003>, Megane li Sedan 1.9 Dci 2003>2005, Megane li Sedan 2.0 2003>, Megane li Sedan 2.0 Dci 2005>, Scénic li 1.4 2003>2008, Scénic li 1.5 Dci 2003>2005, Scénic li 1.6 2003>2006, Scénic li 1.9 Dci 2003>2006, Scénic li 2.0 2003>2009, Scénic li 2.0 16V Turbo 2004>2008, Scénic li 2.0 Dci 2005>2008

GS2490
REAR WHEEL SENSOR (RIGHT SIDE)

REPLACES / REEMPLAZA:

Fiat: 51782490

APPLICATION / APLICACIÓN:

Fiat: Fiorino, Linea, Fiorino Qubo

PS: set of GS2165

GS2491 // NEW //
REAR WHEEL SENSOR (BOTH SIDES)

REPLACES / REEMPLAZA:
Renault: 479006271R, 0265008938; **Bosch:** 0 265 008 938; **Delphi:** SS20366; **Meat & Doria:** 90503, 90503E; **Mobiletron:** AB-EU295

APPLICATION / APLICACIÓN:

RENAULT: Fluence 1.5 Dci 2008>, Fluence 1.5 Dci 2010>, Fluence 1.6 2013>, Fluence 1.6 16V 2008>, Fluence 1.6 16V 2010>, Fluence 1.6 Dci 2014>, Fluence 1.6 Lpg 16V 2012>, Fluence 2.0 2011>, Fluence 2.0 16V 2010>, Fluence 2.0 Flex 2010>, Fluence Z.E. 2012>, Grand Scénic Iii 1.2 Tce 2012>, Grand Scénic Iii 1.2 Tce 2013>, Grand Scénic Iii 1.4 16V 2009>, Grand Scénic Iii 1.5 Dci 2008>, Grand Scénic Iii 1.6 16V 2009>, Grand Scénic Iii 1.6 16V Bifuel 2009>, Grand Scénic Iii 1.6 Dci 2011>, Grand Scénic Iii 1.6 E85 2009>, Grand Scénic Iii 1.9 Dci 2009>, Grand Scénic Iii 2.0 16V 2009>, Grand Scénic Iii 2.0 Dci 2009>, Megane Cc 1.2 Tce 2012>, Megane Cc 1.2 Tce 2013>, Megane Cc 1.4 Tce 2010>, Megane Cc 1.5 Dci 2010>, Megane Cc 1.5 Dci 2013>, Megane Cc 1.6 16V 2010>, Megane Cc 1.6 16V Hi-Flex 2010>, Megane Cc 1.6 Dci 2011>, Megane Cc 1.9 Dci 2010>, Megane Cc 2.0 Cvt 2010>, Megane Cc 2.0 Dci 2010>, Megane Cc 2.0 Tce 2010>, Megane Iii Combi Van 1.5 Dci 2008>, Megane Iii Combi Van 1.5 Dci 2010>, Megane Iii Coupe 1.2 Tce 2013>, Megane Iii Coupe 1.2 Tce 2012>, Megane Iii Coupe 1.4 Tce 2009>, Megane Iii Coupe 1.5 Dci 2008>, Megane Iii Coupe 1.5 Dci 2009>, Megane Iii Coupe 1.6 16V 2008>, Megane Iii Coupe 1.6 16V Bifuel 2008>, Megane Iii Coupe 1.6 Dci 2011>, Megane Iii Coupe 1.9 Dci 2008>, Megane Iii Coupe 2.0 Cvt 2009>, Megane Iii Coupe 2.0 Cvt 2012>, Megane Iii Coupe 2.0 Dci 2009>, Megane Iii Coupe 2.0 R.S. 2008>, Megane Iii Coupe 2.0 Tce 2012>, Megane Iii Coupe 2.0 Tce 2008>, Megane Iii Coupe 2.0 Tce 2009>, Megane Iii Coupe 2.0 Tce 220 2013>, Megane Iii Grandtour 1.2 Tce 2013>, Megane Iii Grandtour 1.2 Tce 2012>, Megane Iii Grandtour 1.4 Tce 2009>, Megane Iii Grandtour 1.5 Dci 2008>, Megane Iii Grandtour 1.5 Dci 2009>, Megane Iii Grandtour 1.6 16V 2009>, Megane Iii Grandtour 1.6 Bifuel 2008>, Megane Iii Grandtour 1.6 Dci 2011>, Megane Iii Grandtour 1.9 Dci 2009>, Megane Iii Grandtour 2.0 Cvt 2009>, Megane Iii Grandtour 2.0 Dci 2012>, Megane Iii Grandtour 2.0 Dci 2009>, Megane Iii Grandtour 2.0 Dci 2010>, Megane Iii Grandtour 2.0 Tce 2012>, Megane Iii Grandtour 2.0 Tce 2008>, Megane Iii Hatchback 1.2 Tce 2013>, Megane Iii Hatchback 1.2 Tce 2012>, Megane Iii Hatchback 1.4 Tce 2009>, Megane Iii Hatchback 1.5 Dci 2008>, Megane Iii Hatchback 1.5 Dci 2009>, Megane Iii Hatchback 1.5 Dci 2013>, Megane Iii Hatchback 1.6 16V 2008>, Megane Iii Hatchback 1.6 16V 2010>, Megane Iii Hatchback 1.9 Dci 2008>, Megane Iii Hatchback 2.0 2011>, Megane Iii Hatchback 2.0 Cvt 2009>, Megane Iii Hatchback 2.0 Dci 2012>, Megane Iii Hatchback 2.0 Dci 2009>, Megane Iii Hatchback 2.0 Dci 2010>, Megane Iii Hatchback 2.0 Tce 2012>, Megane Iii Hatchback 2.0 Tce 2008>, Megane Iii Hatchback 2.0 Tce 220 2013>, Megane Iii Hatchback Van 1.5 Dci 2008>, Megane Iii Hatchback Van 1.5 Dci 2009>, Scénic Iii 1.2 Tce 2012>, Scénic Iii 1.2 Tce 2013>, Scénic Iii 1.4 16V 2009>, Scénic Iii 1.5 Dci 2008>, Scénic Iii 1.5 Dci 2010>, Scénic Iii 1.6 16V 2009>, Scénic Iii 1.6 16V Bifuel 2009>, Scénic Iii 1.6 Dci 2011>, Scénic Iii 1.6 E85 2009>, Scénic Iii 1.9 Dci 2009>, Scénic Iii 2.0 16V 2008>, Scénic Iii 2.0 16V 2009>, Scénic Iii 2.0 Dci 2009>

GS2492 // NEW //
FRONT WHEEL SENSOR (BOTH SIDES)

REPLACES / REEMPLAZA:
Renault: 479109155R, 479100004R, 0265008941; **Bosch:** 0 265 008 941; **Meat & Doria:** 90501, 90501E; **Mobiletron:** AB-EU166

APPLICATION / APLICACIÓN:

DACIA: Duster 1.0 Tce 100 2019>, Duster 1.0 Tce 100 4X4 2019>, Duster 1.2 Tce 125 2017>, Duster 1.2 Tce 125 4X4 2017>, Duster 1.3 Tce 130 2019>, Duster 1.3 Tce 130 4X4 2019>, Duster 1.3 Tce 150 2019>, Duster 1.3 Tce 150 4X4 2019>, Duster 1.5 Dci 110 2017>, Duster 1.5 Dci 110 4X4 2017>, Duster 1.5 Dci 115 2017>, Duster 1.5 Dci 115 4X4 2017>, Duster 1.5 Dci 90 2017>, Duster 1.5 Dci 95 2017>, Duster 1.6 Sce 115 2017>, Duster 1.6 Sce 115 4X4 2017>, Duster 1.6 Sce 115 Lpg 2017>, Duster 1.2 Tce 125 2013>, Duster 1.2 Tce 125 4X4 2013>, Duster 1.5 Dci 2008>, Duster 1.5 Dci 4X4 2010>, Duster 1.6 16V 2008>, Duster 1.6 16V 4X4 2010>, Duster 1.6 16V Hi-Flex 2010>, Duster 1.6 16V Lpg 2011>, Duster 1.6 Sce 115 2015>, Duster 1.6 Sce 115 4X4 2015>, Duster 1.6 Sce 115 Lpg 2015>, Duster Box 1.2 Tce 125 4X4 2013>, Duster Box 1.5 Dci 2008>, Duster Box 1.5 Dci 4X4 2010>, Duster Box 1.6 16V 2008>, Duster Box 1.6 16V 4X4 2010>, Duster Box 1.6 16V Hi-Flex 2010>, Duster Box 1.6 Sce 115 2015>, Duster Box 1.6 Sce 115 4X4 2015> **RENAULT:** Arkana I 1.3 Tce 150 2019>, Arkana I 1.3 Tce 150 4X4 2019>, Arkana I 1.6 2013>, Arkana I 1.6 4X4 2019>, Duster 1.5 Dci 110 2017>, Duster 1.5 Dci 110 4X4 2017>, Duster 1.5 Dci 4X4 2010>, Duster 1.5 Dci 4X4 2013>, Duster 1.6 16V 2012>, Duster 1.6 16V 4X4 2010>, Duster 1.6 16V 4X4 2011>, Duster 1.6 Hi-Flex 2011>, Duster 2.0 2011>, Duster 2.0 4X4 2011>, Duster 2.0 Flex 2010>, Duster 2.0 Flex 4X4 2013>, Duster 2.0 Hi-Flex 2011>, Duster 2.0 Hi-Flex 4X4 2011>, Fluence 1.5 Dci 2008>, Fluence 1.5 Dci 2010>, Fluence 1.6 2013>, Fluence 1.6 16V 2008>, Fluence 1.6 16V 2010>, Fluence 1.6 Dci 2014>, Fluence 1.6 Lpg 16V 2012>, Fluence 2.0 2011>, Fluence 2.0 16V 2010>, Fluence 2.0 Flex 2010>, Fluence Z.E. 2012>, Grand Scénic Iii 1.2 Tce 2012>, Grand Scénic Iii 1.2 Tce 2013>, Grand Scénic Iii 1.4 16V 2009>, Grand Scénic Iii 1.5 Dci 2008>, Grand Scénic Iii 1.6 16V 2009>, Grand Scénic Iii 1.6 16V Bifuel 2009>, Grand Scénic Iii 1.6 Dci 2011>, Grand Scénic Iii 1.6 E85 2009>, Grand Scénic Iii 1.9 Dci 2009>, Grand Scénic Iii 2.0 16V 2009>, Grand Scénic Iii 2.0 Dci 2009>, Megane Cc 1.2 Tce 2012>, Megane Cc 1.2 Tce 2013>, Megane Cc 1.4 Tce 2010>, Megane Cc 1.5 Dci 2010>, Megane Cc 1.5 Dci 2013>, Megane Cc 1.6 16V 2010>, Megane Cc 1.6 16V Hi-Flex 2010>, Megane Cc 1.6 Dci 2011>, Megane Cc 1.9 Dci 2010>, Megane Cc 2.0 Cvt 2010>, Megane Cc 2.0 Dci 2010>, Megane Iii Combi Van 1.5 Dci 2008>, Megane Iii Combi Van 1.5 Dci 2010>, Megane Iii Coupe 1.2 Tce 2013>, Megane Iii Coupe 1.2 Tce 2012>, Megane Iii Coupe 1.4 Tce 2009>, Megane Iii Coupe 1.5 Dci 2008>, Megane Iii Coupe 1.5 Dci 2009>, Megane Iii Coupe 1.6 16V 2008>, Megane Iii Coupe 1.6 16V Bifuel 2008>, Megane Iii Coupe 1.6 Dci 2011>, Megane Iii Coupe 1.9 Dci 2008>, Megane Iii Coupe 2.0 Cvt 2009>, Megane Iii Coupe 2.0 Dci 2012>, Megane Iii Coupe 2.0 Dci 2009>, Megane Iii Coupe 2.0 Tce 2012>, Megane Iii Coupe 2.0 Tce 220 2013>, Megane Iii Grandtour 1.2 Tce 2013>, Megane Iii Grandtour 1.2 Tce 2012>, Megane Iii Grandtour 1.4 Tce 2009>, Megane Iii Grandtour 1.5 Dci 2008>, Megane Iii Grandtour 1.5 Dci 2009>, Megane Iii Grandtour 1.6 16V 2009>, Megane Iii Grandtour 1.6 Bifuel 2008>, Megane Iii Grandtour 1.6 Dci 2011>, Megane Iii Grandtour 1.9 Dci 2009>, Megane Iii Grandtour 2.0 Cvt 2009>, Megane Iii Grandtour 2.0 Dci 2012>, Megane Iii Grandtour 2.0 Dci 2009>, Megane Iii Grandtour 2.0 Dci 2010>, Megane Iii Grandtour 2.0 Tce 2012>, Megane Iii Hatchback 1.2 Tce 2013>, Megane Iii Hatchback 1.2 Tce 2012>, Megane Iii Hatchback 1.4 Tce 2009>, Megane Iii Hatchback 1.5 Dci 2008>, Megane Iii Hatchback 1.5 Dci 2009>, Megane Iii Hatchback 1.5 Dci 2013>, Megane Iii Hatchback 1.6 16V 2008>, Megane Iii Hatchback 1.6 16V 2010>, Megane Iii Hatchback 1.6 16V Bifuel 2009>, Megane Iii Hatchback 1.6 16V Hi-Flex 2008>, Megane Iii Hatchback 1.6 Dci 2011>, Megane Iii Hatchback 1.9 Dci 2008>, Megane Iii Hatchback 2.0 2011>, Megane Iii Hatchback 2.0 Cvt 2009>, Megane Iii Hatchback 2.0 Dci 2012>, Megane Iii Hatchback 2.0 Dci 2009>, Megane Iii Hatchback 2.0 Dci 2010>, Megane Iii Hatchback 2.0 Tce 2012>, Megane Iii Hatchback 2.0 Tce 2008>, Megane Iii Hatchback 2.0 Tce 220 2013>, Megane Iii Hatchback Van 1.5 Dci 2008>, Megane Iii Hatchback Van 1.5 Dci 2009>, Oroch 1.6 Flex 2015>, Oroch 2.0 Flex 2010>, Scénic Iii 1.2 Tce 2012>, Scénic Iii 1.2 Tce 2013>, Scénic Iii 1.4 16V 2009>, Scénic Iii 1.5 Dci 2008>, Scénic Iii 1.5 Dci 2010>, Scénic Iii 1.6 16V 2009>, Scénic Iii 1.6 16V Bifuel 2009>, Scénic Iii 1.6 Dci 2011>, Scénic Iii 1.6 E85 2009>, Scénic Iii 1.9 Dci 2009>, Scénic Iii 2.0 16V 2008>, Scénic Iii 2.0 16V 2009>, Scénic Iii 2.0 Dci 2009>

GS2493 // NEW //
FRONT WHEEL SENSOR (BOTH SIDES)

REPLACES / REEMPLAZA:
Renault: 8200583498, 0265008077; **Delphi:** SS20155; **Cargo:** 182361; **Meat & Doria:** 90327, 90327E; **Mobiletron:** AB-EU031

APPLICATION / APLICACIÓN:
NISSAN: Primastar Box 1.9 Dci 100 2002>0, Primastar Box 1.9 Dci 80 2002>0, Primastar Box 2.0 2001>0, Primastar Box 2.0 Dci 115 2006>0, Primastar Box 2.0 Dci 90 2006>0, Primastar Box 2.5 Dci 115 2008>0, Primastar Box 2.5 Dci 140 2002>0, Primastar Box 2.5 Dci 150 2006>0, Primastar Bus 2.0 2001>0, Primastar Bus Dci 100 2001>0, Primastar Bus Dci 115 2008>0, Primastar Bus Dci 120 2006>0, Primastar Bus Dci 140 2003>0, Primastar Bus Dci 150 2006>0, Primastar Bus Dci 80 2001>0, Primastar Bus Dci 90 2006>0, Primastar Platparam/Chassis 1.9 Dci 100 2002>0, Primastar Platparam/Chassis 1.9 Dci 80 2002>0, Primastar Platparam/Chassis 2.0 2001>0, Primastar Platparam/Chassis 2.5 Dci 140 2002>0, Primastar Platparam/Chassis 2.5 Dci 150 2006>0;

OPEL: Vivaro A Box 1.9 Di 2001>0, Vivaro A Box 1.9 Dti 2001>0, Vivaro A Box 2.0 16V 2001>0, Vivaro A Box 2.0 Cdti 2006>0, Vivaro A Box 2.0 Ecotec 2006>0, Vivaro A Box 2.5 Cdti 2006>0, Vivaro A Box 2.5 Dti 2003>0, Vivaro A Combi 1.9 Di 2001>0, Vivaro A Combi 1.9 Dti 2001>0, Vivaro A Combi 2.0 16V 2001>0, Vivaro A Combi 2.0 Cdti 2006>0, Vivaro A Combi 2.0 Ecotec 2006>0, Vivaro A Combi 2.5 Cdti 2006>0, Vivaro A Combi 2.5 Dti 2003>0, Vivaro A Platparam/Chassis 1.9 Di 2001>0, Vivaro A Platparam/Chassis 1.9 Dti 2001>0, Vivaro A Platparam/Chassis 2.0 16V 2001>0, Vivaro A Platparam/Chassis 2.0 Cdti 2006>0, Vivaro A Platparam/Chassis 2.0 Ecotec 2006>0, Vivaro A Platparam/Chassis 2.5 Cdti 2003>0, Vivaro A Platparam/Chassis 2.5 Dti 2003>0;

RENAULT: Trafic li Box 1.9 Dci 2001>0, Trafic li Box 1.9 Dci 100 2001>0, Trafic li Box 1.9 Dci 80 2001>0, Trafic li Box 2.0 2001>0, Trafic li Box 2.0 16V 2001>0, Trafic li Box 2.0 Dci 115 2006>0, Trafic li Box 2.0 Dci 90 2006>0, Trafic li Box 2.5 Dci 2007>0, Trafic li Box 2.5 Dci 135 2003>0, Trafic li Box 2.5 Dci 145 2006>0, Trafic li Box 2.5 Dti 2003>0, Trafic li Bus 1.9 Dci 2001>0, Trafic li Bus 1.9 Dci 100 2001>0, Trafic li Bus 1.9 Dci 80 2001>0, Trafic li Bus 2.0 2001>0, Trafic li Bus 2.0 16V 2001>0, Trafic li Bus 2.0 Dci 115 2006>0, Trafic li Bus 2.0 Dci 90 2006>0, Trafic li Bus 2.5 Dci 115 2008>0, Trafic li Bus 2.5 Dci 135 2003>0, Trafic li Bus 2.5 Dci 145 2006>0, Trafic li Platparam/Chassis 1.9 Dci 2001>0, Trafic li Platparam/Chassis 1.9 Dci 100 2001>0, Trafic li Platparam/Chassis 1.9 Dci 80 2001>0, Trafic li Platparam/Chassis 2.0 2001>0, Trafic li Platparam/Chassis 2.0 16V 2001>0, Trafic li Platparam/Chassis 2.0 Dci 115 2006>0, Trafic li Platparam/Chassis 2.0 Dci 90 2006>0, Trafic li Platparam/Chassis 2.5 Dci 2007>0, Trafic li Platparam/Chassis 2.5 Dci 135 2001>0, Trafic li Platparam/Chassis 2.5 Dci 145 2006>0;

VAUXHALL: Vivaro A Box 1.9 Di 2001>0, Vivaro A Box 1.9 Dti 2001>0, Vivaro A Box 2.0 16V 2001>0, Vivaro A Box 2.0 Cdti 2006>0, Vivaro A Box 2.0 Ecotec 2006>0, Vivaro A Box 2.5 Cdti 2003>0, Vivaro A Box 2.5 Dti 2003>0, Vivaro A Combi 1.9 Di 2001>0, Vivaro A Combi 1.9 Dti 2001>0, Vivaro A Combi 2.0 16V 2001>0, Vivaro A Combi 2.0 Cdti 2006>0, Vivaro A Combi 2.0 Ecotec 2006>0, Vivaro A Combi 2.5 Cdti 2003>0, Vivaro A Combi 2.5 Dti 2003>0, Vivaro A Platparam/Chassis 1.9 Di 2001>0, Vivaro A Platparam/Chassis 1.9 Dti 2001>0, Vivaro A Platparam/Chassis 2.0 16V 2001>0, Vivaro A Platparam/Chassis 2.0 Cdti 2006>0, Vivaro A Platparam/Chassis 2.0 Ecotec 2006>0, Vivaro A Platparam/Chassis 2.5 Cdti 2003>0

GS2494 // NEW //
REAR WHEEL SENSOR (BOTH SIDES)

REPLACES / REEMPLAZA:
Renault: 8200724127, 0265008078, 0986594588; **Bosch:** 0 986 594 588; **Delphi:** SS20247; **Cargo:** 182354; **Meat & Doria:** 90328; **Mobiletron:** AB-EU035

APPLICATION / APLICACIÓN:
NISSAN: Primastar Furgão 1.9 Dci 100 2002>, Primastar Furgão 1.9 Dci 80 2002>, Primastar Furgão 2.0 2003>, Primastar Furgão 2.0 Dci 115 2006>, Primastar Furgão 2.0 Dci 90 2006>, Primastar Furgão 2.5 Dci 140 2003>, Primastar Furgão 2.5 Dci 150 2006>, Primastar Van De Passageiro 2.0 2001>, Primastar Van De Passageiro Dci 100 2001>, Primastar Van De Passageiro Dci 120 2006>, Primastar Van De Passageiro Dci 140 2003>, Primastar Van De Passageiro Dci 150 2006>, Primastar Van De Passageiro Dci 80 2001>, Primastar Van De Passageiro Dci 90 2006>;

OPEL: Vivaro A truck De Plataparama/Chassis 1.9 Dti 2006>, Vivaro A truck De Plataparama/Chassis 1.9 Di 2001>, Vivaro A truck De Plataparama/Chassis 2.0 16V 2003>, Vivaro A truck De Plataparama/Chassis 2.0 Cdti 2006>, Vivaro A truck De Plataparama/Chassis 2.0 Ecotec 2006>, Vivaro A truck De Plataparama/Chassis 2.5 Cdti 2006>, Vivaro A truck De Plataparama/Chassis 2.5 Dti 2003>, Vivaro A Combi 1.9 Di 2001>, Vivaro A Combi 1.9 Dti 2001>, Vivaro A Combi 2.0 16V 2001>, Vivaro A Combi 2.0 Cdti 2006>, Vivaro A Combi 2.0 Ecotec 2006>, Vivaro A Combi 2.5 Cdti 2006>, Vivaro A Combi 2.5 Dti 2003>, Vivaro A Furgão 1.9 Di 2001>, Vivaro A Furgão 1.9 Dti 2001>, Vivaro A Furgão 2.0 16V 2001>, Vivaro A Furgão 2.0 Cdti 2006>, Vivaro A Furgão 2.0 Ecotec 2006>, Vivaro A Furgão 2.5 Cdti 2006>, Vivaro A Furgão 2.5 Dti 2003>;

RENAULT: Trafic li truck De Plataparama/Chassis 1.9 Dci 100 2001>, Trafic li truck De Plataparama/Chassis 1.9 Dci 80 2001>, Trafic li truck De Plataparama/Chassis 2.0 2001>, Trafic li truck De Plataparama/Chassis 2.0 Dci 115 2006>, Trafic li truck De Plataparama/Chassis 2.0 Dci 90 2006>, Trafic li truck De Plataparama/Chassis 2.5 Dci 135 2001>, Trafic li truck De Plataparama/Chassis 2.5 Dci 145 2006>, Trafic li Furgão 1.9 Dci 100 2001>, Trafic li Furgão 1.9 Dci 80 2001>, Trafic li Furgão 2.0 2001>, Trafic li Furgão 2.0 16V 2006>, Trafic li Furgão 2.0 Dci 115 2006>, Trafic li Furgão 2.0 Dci 90 2006>, Trafic li Furgão 2.5 Dci 135 2003>, Trafic li Furgão 2.5 Dci 145 2006>, Trafic li Van De Passageiro 1.9 Dci 100 2001>, Trafic li Van De Passageiro 1.9 Dci 80 2001>, Trafic li Van De Passageiro 2.0 2001>, Trafic li Van De Passageiro 2.0 16V 2006>, Trafic li Van De Passageiro 2.0 Dci 115 2006>, Trafic li Van De Passageiro 2.0 Dci 90 2006>, Trafic li Van De Passageiro 2.5 Dci 115 2008>, Trafic li Van De Passageiro 2.5 Dci 135 2003>, Trafic li Van De Passageiro 2.5 Dci 145 2006>

GS2495 // NEW //
FRONT WHEEL SENSOR (LEFT SIDE)

REPLACES / REEMPLAZA:
Toyota: 8954335050, 895430C010, 8954335050;

Meat & Doria: 90942E; **Mobiletron:** AB-JP044

APPLICATION / APLICACIÓN:
TOYOTA: 4 Runner 2.7 4Wd 1995>0, 4 Runner 3.4 4Wd 1995>0, Land Cruiser 90 2.7 1995>0, Land Cruiser 90 3.0 D-4D 4Wd 2000>0, Land Cruiser 90 3.0 Td 1995>0, Land Cruiser 90 3.0 Td 1996>0, Land Cruiser 90 3.4 I 24V 1996>0

GS2496 // NEW //
FRONT WHEEL SENSOR (RIGHT SIDE)

REPLACES / REEMPLAZA:
Toyota: 8954235050, 895420C010; **A.B.S.:** 31563

APPLICATION / APLICACIÓN:
TOYOTA: 4 Runner 2.7 4Wd 1995>0, 4 Runner 3.4 4Wd 1995>0, Land Cruiser 90 2.7 1995>0, Land Cruiser 90 3.0 D-4D 4Wd 2000>0, Land Cruiser 90 3.0 Td 1995>0, Land Cruiser 90 3.0 Td 1996>0, Land Cruiser 90 3.4 I 24V 1996>0

GS2497 // NEW //
REAR WHEEL SENSOR (RIGHT SIDE)

REPLACES / REEMPLAZA:
Toyota: 8954535030; **A.B.S.:** 31019

APPLICATION / APLICACIÓN:
TOYOTA: 4 Runner 2.7 4Wd 1995>0, 4 Runner 3.4 4Wd 1995>0, Land Cruiser 90 2.7 1995>0, Land Cruiser 90 3.0 D-4D 4Wd 2000>0, Land Cruiser 90 3.0 Td 1995>0, Land Cruiser 90 3.0 Td 1996>0, Land Cruiser 90 3.4 I 24V 1996>0

GS2498 // NEW //
REAR WHEEL SENSOR (LEFT SIDE)

REPLACES / REEMPLAZA:
Toyota: 8954635030, 895450C010

APPLICATION / APLICACIÓN:
TOYOTA: 4 Runner 2.7 4Wd 1995>0, 4 Runner 3.4 4Wd 1995>0, Land Cruiser 90 2.7 1995>0, Land Cruiser 90 3.0 D-4D 4Wd 2000>0, Land Cruiser 90 3.0 Td 1995>0, Land Cruiser 90 3.0 Td 1996>0, Land Cruiser 90 3.4 I 24V 1996>0

GS2499 // NEW //
FRONT WHEEL SENSOR (BOTH SIDES)
REPLACES / REEMPLAZA:
Mercedes-Benz: 2045400517, A2045400517, 2049058000, 2049053105; **Bosch:** 0 986 594 641; **A.B.S.:** 30406; **Meat & Doria:** 90636, 90636E; **Mobiletron:** AB-EU358

APPLICATION / APLICACIÓN:
MERCEDES-BENZ: C-Class C 220 Cdi 4-Matic 2013>0, C-Class C 250 Cdi 4-Matic 2011>0, C-Class C 300 4-Matic 2011>0, C-Class C 300 Cdi 4-Matic 2011>0, C-Class C 350 4-Matic 2011>0, C-Class C 350 Cdi 4-Matic 2009>0, C-Class T-Model C 220 Cdi 4-Matic 2013>0, C-Class T-Model C 250 Cdi 4-Matic 2010>0, C-Class T-Model C 300 Cdi 4-Matic 2011>0, C-Class T-Model C 350 Cdi 4-Matic 2009>0, Glk-Class 200 2013>0, Glk-Class 200 Cdi 2010>0, Glk-Class 220 Cdi 2008>0, Glk-Class 220 Cdi 4-Matic 2008>0, Glk-Class 250 2013>0, Glk-Class 250 4-Matic 2013>0, Glk-Class 250 Cdi 4-Matic 2009>0, Glk-Class 300 4-Matic 2009>0, Glk-Class 350 2009>0, Glk-Class 350 4-Matic 2008>0, Glk-Class 350 Cdi 4-Matic 2009>0, Glk-Class 350 Cdi 4-Matic 2012>0

GS2500 // NEW //
REAR WHEEL SENSOR (LEFT SIDE)
REPLACES / REEMPLAZA:
Renault: 479006554R, 0265008943, 0265008957; **Bosch:** 0 265 007 529, 0 265 008 327; **Delphi:** SS20349; **Meat & Doria:** 90026; **Mobiletron:** AB-EU394; **A.B.S.:** 30388

APPLICATION / APLICACIÓN:
RENAULT: Clío li 1.2 (Bb0A, Bb0F, Bb10, Bb1K, Bb28, Bb2D, Bb2H, Cb0A,... 1998>, Clío li 1.2 16V (Bb05, Bb0W, Bb11, Bb27, Bb2T, Bb2U, Bb2V, Cb05,... 2001>, Clío li 1.2 Lpg 1998>2009, Clío li 1.4 1998>2005, Clío li 1.4 16V 1999>2004, Clío li 1.5 Dci 2001>2003, Clío li 1.6 1998>2005, Clío li 1.6 16V (Bb01, Bb0H, Bb0T, Bb14, Bb1D, Bb1R, Bb2KI, Bb3G... 1998>, Clío li 1.9 D 1998>2005, Clío li 2.0 16V Sport 2000>, Clío li Furgão 1.5 Dci 2001>, Thalia I 1.2 16V 2002>, Thalia I 1.4 2000>, Thalia I 1.4 16V 2000>, Thalia I 1.5 Dci 2001>2009

GS2501 // NEW //
REAR WHEEL SENSOR (RIGHT SIDE)
REPLACES / REEMPLAZA:
Renault: 479001745R, 8200254685; **Bosch:** 0 265 008 944; **A.B.S.:** 30389; **Delphi:** SS20347; **Meat & Doria:** 90025

APPLICATION / APLICACIÓN:
RENAULT: Clío li 1.0 2001>0, Clío li 1.0 Flex 2005>0, Clío li 1.2 1998>0, Clío li 1.2 16V 2001>0, Clío li 1.2 Lpg 1998>0, Clío li 1.4 1998>0, Clío li 1.4 16V 1999>0, Clío li 1.4 16V 2000>0, Clío li 1.5 Dci 2001>0, Clío li 1.5 Dci 2004>0, Clío li 1.5 Dci 2005>0, Clío li 1.5 Dci 2007>0, Clío li 1.6 2004>0, Clío li 1.6 1998>0, Clío li 1.6 16V 1999>0, Clío li 1.6 16V 1998>0, Clío li 1.6 Flex 2000>0, Clío li 1.9 D 1998>0, Clío li 1.9 Dti 1999>0, Clío li 2.0 16V Sport 2004>0, Clío li 2.0 16V Sport 2000>0, Clío li Box 1.2 1999>0, Clío li Box 1.2 1998>0, Clío li Box 1.5 Dci 2001>0, Clío li Box 1.6 2003>0, Clío li Box 1.9 D 1998>0, Thalia I 1.2 16V 2002>0, Thalia I 1.4 2000>0, Thalia I 1.4 16V 2000>0, Thalia I 1.5 Dci 2001>0, Thalia I 1.6 Authentique Hi-Flex 2004>0, Thalia li 1.2 16V 2008>0, Thalia li 1.2 Lpg 1998>0, Thalia li 1.4 2008>0, Thalia li 1.5 Dci 2001>0, Thalia li 1.6 16V 1999>0, Thalia li 1.6 Flex 2000>0

GS2502 // NEW //
FRONT WHEEL SENSOR (BOTH SIDES)
REPLACES / REEMPLAZA:
Renault: 8200933549, 8200186294, 0265008393, 0265007527; **Bosch:** 0 265 008 393, 0 265 008 945; **Meat & Doria:** 90521; **Mobiletron:** AB-EU435

APPLICATION / APLICACIÓN:
RENAULT: Clío li 1.2 (Bb0A, Bb0F, Bb10, Bb1K, Bb28, Bb2D, Bb2H, Cb0A,... 1998>, Clío li 1.2 16V (Bb05, Bb0W, Bb11, Bb27, Bb2T, Bb2U, Bb2V, Cb05,... 2001>, Clío li 1.2 Lpg 1998>2009, Clío li 1.5 Dci 2001>2009, Clío li 1.6 16V (Bb01, Bb0H, Bb0T, Bb14, Bb1D, Bb1R, Bb2KI, Bb3G... 1998>, Clío li 2.0 16V Sport 2000>, Clío li 3.0 V6 Sport 2002>, Clío li Furgão 1.5 Dci 2001>, Thalia I 1.2 16V 2002>, Thalia I 1.4 2000>, Thalia I 1.4 16V 2000>, Thalia I 1.5 Dci 2001>2009

GS2503 // NEW //
FRONT WHEEL SENSOR (BOTH SIDES)
REPLACES / REEMPLAZA:
Subaru: 27540AG111, 27540AG101, 27540AG10B, 27540AG11B, 0265008339, 0265008338; **Meat & Doria:** 90800; **Mobiletron:** AB-JP043

APPLICATION / APLICACIÓN:
SUBARU: paraester 2.0 Awd 2005>0, paraester 2.0 D Awd 2008>0, paraester 2.5 Awd 2008>0, paraester 2.0 I Awd 2011>0, Impreza Hatchback 1.5 Awd 2008>0, Impreza Hatchback 1.5 F 2008>0, Impreza Hatchback 2.0 D Awd 2008>0, Impreza Hatchback 2.0 R Awd 2008>0, Impreza Hatchback 2.5 Awd 2008>0, Impreza Hatchback 2.5 Sti Cs400 Awd 2010>0, Impreza Hatchback 2.5 Wrx S Awd 2009>0, Impreza Hatchback 2.5 Wrx Sti 330S Awd 2009>0, Impreza Hatchback 2.5 Wrx Sti Awd 2008>0, Impreza Saloon 1.5 2008>0, Impreza Saloon 1.5 Awd 2008>0, Impreza Saloon 2.0 I Awd 2011>0, Impreza Saloon 2.5 Awd 2008>0, Impreza Saloon 2.5 Wrx Se Awd 2009>0, Impreza Saloon 2.5 Wrx Sti Awd 2011>0, Legacy Iv 2.0 Awd 2005>0, Legacy Iv 2.0 D Awd 2008>0, Legacy Iv 2.0 R Awd 2007>0, Legacy Iv 2.5 Awd 2003>0, Legacy Iv 2.5 I Awd 2007>0, Legacy Iv 3.0 R Awd 2003>0, Legacy Iv Estate 2.0 Awd 2005>0, Legacy Iv Estate 2.0 D Awd 2008>0, Legacy Iv Estate 2.0 R Awd 2007>0, Legacy Iv Estate 2.5 Awd 2003>0, Legacy Iv Estate 2.5 I Awd 2008>0, Legacy Iv Estate 3.0 R Awd 2003>0, Outback 2.0 D Awd 2008>0, Outback 2.5 Awd 2008>0, Outback 2.5 Awd 2003>0, Outback 3.0 Awd 2003>0

GS2504 // NEW //
REAR WHEEL SENSOR (BOTH SIDES)
REPLACES / REEMPLAZA:
Subaru: 27540AG14A, 27540AG14B, 27540AG12A; **Mobiletron:** AB-JP098

APPLICATION / APLICACIÓN:
SUBARU: Legacy V 2.0 D Awd 2009>0, Legacy V 2.0 I Awd 2009>0, Legacy V 2.0 I Lpg Awd 2009>0, Legacy V 2.5 Gt Awd 2010>0, Legacy V 2.5 I Awd 2009>0, Legacy V Estate 2.0 D Awd 2009>0, Legacy V Estate 2.0 I Awd 2009>0, Legacy V Estate 2.0 I Lpg Awd 2009>0, Legacy V Estate 2.5 Cng Awd 2013>0, Legacy V Estate 2.5 Gt Awd 2010>0, Legacy V Estate 2.5 I Awd 2009>0, Legacy V Estate 2.5 I Awd 2012>0, Outback 2.0 D Awd 2009>0, Outback 2.5 Bifuel Awd 2010>0, Outback 2.5 Cng Awd 2013>0, Outback 2.5 I Awd 2012>0, Outback 2.5 I Awd 2009>0, Outback 3.6 Awd 2011>0, Outback 3.6 R Awd 2009>0

GS2505 // NEW //
REAR WHEEL SENSOR (BOTH SIDES)

REPLACES / REEMPLAZA:

Subaru: 27540SC001, 27540SC001, 0265008347, 0265008347; **A.B.S.:** 31692

APPLICATION / APLICACIÓN:

SUBARU: Forester 2.0 Awd 2008>0, Forester 2.0 Bifuel Awd 2009>0, Forester 2.0 D Awd 2008>0, Forester 2.5 Awd 2008>0, Forester 2.5 Turbo Awd 2011>0

GS2506 // NEW //
REAR WHEEL SENSOR (LEFT SIDE)

REPLACES / REEMPLAZA:

Subaru: 27540FG041, 27540FG040, 0265008344; **Meat & Doria:** 90804

APPLICATION / APLICACIÓN:

SUBARU: Impreza Hatchback 1.5 Awd 2008>0, Impreza Hatchback 1.5 F 2008>0, Impreza Hatchback 2.0 D Awd 2009>0, Impreza Hatchback 2.0 R Awd 2008>0, Impreza Hatchback 2.5 Awd 2008>0, Impreza Hatchback 2.5 Sti Cs400 Awd 2010>0, Impreza Hatchback 2.5 Wrx Sti Awd 2008>0, Impreza Saloon 1.5 2008>0, Impreza Saloon 1.5 Awd 2008>0, Impreza Saloon 2.0 I Awd 2011>0, Impreza Saloon 2.5 Wrx Sti Awd 2011>0

GS2507 // NEW //
REAR WHEEL SENSOR (RIGHT SIDE)

REPLACES / REEMPLAZA:

Subaru: 27540FG031, 27540FG030, 0265008345

APPLICATION / APLICACIÓN:

SUBARU: Impreza Hatchback 1.5 Awd 2008>0, Impreza Hatchback 1.5 Bifuel Awd 2010>0, Impreza Hatchback 1.5 F 2008>0, Impreza Hatchback 2.0 D Awd 2009>0, Impreza Hatchback 2.0 R Awd 2008>0, Impreza Hatchback 2.0 R Bifuel Awd 2009>0, Impreza Hatchback 2.5 Awd 2008>0, Impreza Hatchback 2.5 Wrx Se Awd 2010>0, Impreza Hatchback 2.5 Wrx Sti Awd 2008>0, Impreza Saloon 1.5 2008>0, Impreza Saloon 1.5 Awd 2008>0, Impreza Saloon 2.0 I Awd 2011>0, Impreza Saloon 2.5 Awd 2008>0, Impreza Saloon 2.5 Wrx Se Awd 2009>0, Impreza Saloon 2.5 Wrx Sti Awd 2011>0

GS2508 // NEW //
FRONT WHEEL SENSOR (RIGHT SIDE)

REPLACES / REEMPLAZA:

Subaru: 27540AC020

APPLICATION / APLICACIÓN:

SUBARU: Forester 1998>2002, Legacy 1990>1999

GS2509 // NEW //
FRONT WHEEL SENSOR (LEFT SIDE)

REPLACES / REEMPLAZA:

Subaru: 27540AC030

APPLICATION / APLICACIÓN:

SUBARU: Forester 1998>2002, Legacy 1990>1999

GS2510 // NEW //
REAR WHEEL SENSOR (RIGHT SIDE)

REPLACES / REEMPLAZA:

Subaru: 27540FC000, 27540SA000

APPLICATION / APLICACIÓN:

SUBARU: Forester 1998>2006

GS2511 // NEW //
REAR WHEEL SENSOR (LEFT SIDE)

REPLACES / REEMPLAZA:

Subaru: 27540FC010, 27540SA010

APPLICATION / APLICACIÓN:

SUBARU: Forester 1998>2006

GS2512 // NEW //
REAR WHEEL SENSOR (RIGHT SIDE)

REPLACES / REEMPLAZA:

Subaru: 26740AA020, 26740AA021

APPLICATION / APLICACIÓN:

SUBARU: Impreza 1993>2001, Legacy 1990>1999

GS2513 // NEW //
REAR WHEEL SENSOR (LEFT SIDE)

REPLACES / REEMPLAZA:

Subaru: 26740AA030, 26740AA031

APPLICATION / APLICACIÓN:

SUBARU: Impreza 1993>2001, Legacy 1990>1999

GS2514 // NEW //
FRONT WHEEL SENSOR (RIGHT SIDE)

REPLACES / REEMPLAZA:

Subaru: 26740AA000, 26740AA001

APPLICATION / APLICACIÓN:

SUBARU: Impreza 1993>2001

GS2515 // NEW //
FRONT WHEEL SENSOR (LEFT SIDE)

REPLACES / REEMPLAZA:

Subaru: 26740AA010 / 26740AA011

APPLICATION / APLICACIÓN:

SUBARU: Impreza 1993>2001

GS2516 // NEW //
FRONT WHEEL SENSOR (BOTH SIDES)

REPLACES / REEMPLAZA:

Subaru: 27540XA00A

APPLICATION / APLICACIÓN:

SUBARU: Tribeca 2008>2014



GS2517 // NEW //
REAR WHEEL SENSOR (RIGHT SIDE)

REPLACES / REEMPLAZA:

Subaru: 27540XA02A

APPLICATION / APLICACIÓN:

SUBARU: Tribeca 2008>2014

GS2518 // NEW //
FRONT WHEEL SENSOR (RIGHT SIDE)

REPLACES / REEMPLAZA:

Subaru: 27540FJ000, 27540SG000; **Bosch:** 0 265 009 230; **Meat & Doria:** 90811

APPLICATION / APLICACIÓN:

SUBARU: Forester 2.0 Awd 2012>0, Forester 2.0 Bifuel Awd 2013>0, Forester 2.0 D Awd 2012>0, Forester 2.0 I Awd 2012>0, Forester 2.0 Xt Awd 2013>0, Forester 2.5 Awd 2014>0, Impreza Hatchback 1.6 I 2012>0, Impreza Hatchback 1.6 I Awd 2012>0, Impreza Hatchback 2.0 Awd 2012>0, Impreza Saloon 1.6 2015>0, Impreza Saloon 1.6 Awd 2012>0, Impreza Saloon 1.6 Front Wheel Drive 2012>0, Impreza Saloon 2.0 Awd 2011>0, Xv 1.6 Bifuel Awd 2012>0, Xv 1.6 I Awd 2012>0, Xv 2.0 Bifuel Awd 2012>0, Xv 2.0 D Awd 2012>0, Xv 2.0 I Awd 2012>0

GS2519 // NEW //
FRONT WHEEL SENSOR (LEFT SIDE)

REPLACES / REEMPLAZA:

Subaru: 27540SG011; **Bosch:** 0 265 009 452

APPLICATION / APLICACIÓN:

SUBARU: Forester 2.0 Awd 2012>0, Forester 2.0 Bifuel Awd 2013>0, Forester 2.0 D Awd 2012>0, Forester 2.0 I Awd 2012>0, Forester 2.0 Xt Awd 2013>0, Forester 2.5 Awd 2014>0, Impreza Hatchback 1.6 I 2012>0, Impreza Hatchback 1.6 I Awd 2012>0, Impreza Hatchback 2.0 Awd 2012>0, Impreza Saloon 1.6 2015>0, Impreza Saloon 1.6 Awd 2012>0, Impreza Saloon 1.6 Front Wheel Drive 2012>0, Impreza Saloon 2.0 Awd 2011>0, Xv 1.6 Bifuel Awd 2012>0, Xv 1.6 I Awd 2012>0, Xv 2.0 Bifuel Awd 2012>0, Xv 2.0 D Awd 2012>0, Xv 2.0 I Awd 2012>0

GS2520 // NEW //
REAR WHEEL SENSOR (RIGHT SIDE)

REPLACES / REEMPLAZA:

Subaru: 27540SG020; **Bosch:** 0 265 009 228; **Meat & Doria:** 90813

APPLICATION / APLICACIÓN:

SUBARU: Forester 2.0 Awd 2012>0, Forester 2.0 Bifuel Awd 2013>0, Forester 2.0 D Awd 2012>0, Forester 2.0 I Awd 2012>0, Forester 2.0 Xt Awd 2013>0, Forester 2.5 Awd 2014>0, Xv 1.6 Bifuel Awd 2012>0, Xv 1.6 I Awd 2012>0, Xv 2.0 Bifuel Awd 2012>0, Xv 2.0 D Awd 2012>0, Xv 2.0 I Awd 2012>0

GS2521
REAR WHEEL SENSOR

REPLACES / REEMPLAZA:

Bosch: 0 986 594 521; **Peugeot:** 4545C0, 4545G7;

Citroën: 4545C0, 4545G7

APPLICATION / APLICACIÓN:

Peugeot: 407 saloon/sw estate/coupe 1.6/1.8/2.0

Citroën: C6 saloon 2.2/2.7/3.0

GS2522 // NEW //
FRONT WHEEL SENSOR (RIGHT SIDE)

REPLACES / REEMPLAZA:

Subaru: 27540AE000, 27540AE001

APPLICATION / APLICACIÓN:

SUBARU: Impreza 2001>2006, Legacy 2000>2005

GS2523 // NEW //
FRONT WHEEL SENSOR (RIGHT SIDE)

REPLACES / REEMPLAZA:

27540AE000/ 27540AE001

APPLICATION / APLICACIÓN:

SUBARU: Impreza 2001>2006, Legacy 2000>2005

GS2524 // NEW //
FRONT WHEEL SENSOR (RIGHT SIDE)

REPLACES / REEMPLAZA:

27540AE000/ 27540AE001

APPLICATION / APLICACIÓN:

SUBARU: Impreza 2001>2006, Legacy 2000>2005

GS2525 // NEW //
FRONT WHEEL SENSOR (LEFT SIDE)

REPLACES / REEMPLAZA:

Subaru: 27540AE010

APPLICATION / APLICACIÓN:

SUBARU: Impreza 2001>2006, Legacy 2000>2005

GS2526 // NEW //
REAR WHEEL SENSOR (RIGHT SIDE)

REPLACES / REEMPLAZA:

Subaru: 27540AE040; **A.B.S.:** 31488

APPLICATION / APLICACIÓN:

SUBARU: Legacy Iii 2.0 Awd 1999>0, Legacy Iii 2.5 Awd 1998>0, Legacy Iii Estate 2.0 Awd 1998>0, Legacy Iii Estate 2.5 Awd 1998>0, Outback 2.5 Awd 1998>0, Outback 3.0 H6 Awd 2000>0

GS2527 // NEW //
REAR WHEEL SENSOR (LEFT SIDE)

REPLACES / REEMPLAZA:

Subaru: 27540AE050; **A.B.S.:** 31489

APPLICATION / APLICACIÓN:

SUBARU: Legacy Iii 2.0 Awd 1999>0, Legacy Iii 2.5 Awd 1998>0, Legacy Iii Estate 2.0 Awd 1998>0, Legacy Iii Estate 2.5 Awd 1998>0, Outback 2.5 Awd 1998>0, Outback 3.0 H6 Awd 2000>0

GS2528 // NEW //
FRONT WHEEL SENSOR (RIGHT SIDE)

REPLACES / REEMPLAZA:

Subaru: 27540AE020, 27540AE021; **A.B.S.:** 31486

APPLICATION / APLICACIÓN:

SUBARU: Forester 2.0 Awd 2002>0, Forester 2.0 S Turbo Awd 2002>0, Forester 2.0 X Awd 2005>0, Forester 2.5 Awd 2005>0, Forester 2.5 Awd 2003>0, Forester 2.5 Prodrive Performance Pack Awd 2005>0, Forester 2.5 Rx Nato Awd 2002>0, Outback 3.0 H6 Awd 2000>0

GS2529 // NEW //
FRONT WHEEL SENSOR (LEFT SIDE)
REPLACES / REEMPLAZA:
Subaru: 27540AE030, 27540FE130, 27540SA030

APPLICATION / APLICACIÓN:
SUBARU: Forester 2.0 Awd 2002>0, Forester 2.0 S Turbo Awd 2002>0, Forester 2.0 X Awd 2005>0, Forester 2.5 Awd 2005>0, Forester 2.5 Awd 2003>0, Forester 2.5 Prodrive Performance Pack Awd 2005>0, Forester 2.5 Rx Nato Awd 2002>0, Outback 3.0 H6 Awd 2000>0

GS2530
REAR WHEEL SENSOR
REPLACES / REEMPLAZA:
Chevrolet: 13324530, 12783655, 13346945, 13470643

Opel: 13324530, 12783655, 13346945, 13470643

APPLICATION / APLICACIÓN:
Chevrolet: Cruze, Volt

Opel: Astra, Meriva

PS: set of GS2528

GS2531
FRONT WHEEL SENSOR
REPLACES / REEMPLAZA:
Bosch: 0 265 006 201, 0 265 003 131

Peugeot: 6454531, 454544, 96140648, 96181977, 96181979, 96217750

APPLICATION / APLICACIÓN:
Peugeot: 306 hatchback/convertible/break

GS2532 // NEW //
FRONT WHEEL SENSOR (LEFT SIDE)
REPLACES / REEMPLAZA:
Mitsubishi: 4670A189; **A.B.S.:** 31305;

Meat & Doria: 90909E; **Mobiletron:** AB-JP116

APPLICATION / APLICACIÓN:
MITSUBISHI: Pajero Iv 3.0 4Wd 2007>0, Pajero Iv 3.2 Di-D 2006>0, Pajero Iv 3.2 Di-D 2007>0, Pajero Iv 3.2 Di-D 4Wd 2007>0, Pajero Iv 3.2 Di-D Gls 2007>0, Pajero Iv 3.5 V6 4Wd 2009>0, Pajero Iv 3.8 V6 2006>0, Pajero Iv 3.8 V6 2007>0, Pajero Iv Van 3.2 Di-D 2006>0, Pajero Iv Van 3.2 Di-D 4Wd 2007>0, Pajero Iv Van 3.2 Td 4Wd 2010>0

GS2533 // NEW //
FRONT WHEEL SENSOR (RIGHT SIDE)
REPLACES / REEMPLAZA:
Mitsubishi: 4670A190; **A.B.S.:** 31306;

Meat & Doria: 90910E; **Mobiletron:** AB-JP117

APPLICATION / APLICACIÓN:
MITSUBISHI: Pajero Iv 3.0 4Wd 2007>0, Pajero Iv 3.2 Di-D 2006>0, Pajero Iv 3.2 Di-D 2007>0, Pajero Iv 3.2 Di-D 4Wd 2007>0, Pajero Iv 3.2 Di-D Gls 2007>0, Pajero Iv 3.5 V6 4Wd 2009>0, Pajero Iv 3.8 V6 2006>0, Pajero Iv 3.8 V6 2007>0, Pajero Iv Van 3.2 Di-D 2006>0, Pajero Iv Van 3.2 Di-D 4Wd 2007>0, Pajero Iv Van 3.2 Td 4Wd 2010>0

GS2534 // NEW //
REAR WHEEL SENSOR (LEFT SIDE)
REPLACES / REEMPLAZA:
Mitsubishi: 4670A255; **A.B.S.:** 31630

APPLICATION / APLICACIÓN:
MITSUBISHI: Pajero Iv 3.0 4Wd 2007>0, Pajero Iv 3.2 Di-D 2007>0, Pajero Iv 3.2 Di-D 4Wd 2007>0, Pajero Iv 3.8 V6 2006>0, Pajero Iv Van 3.2 Di-D 2006>0, Pajero Iv Van 3.2 Di-D 4Wd 2007>0, Pajero Iv Van 3.2 Td 4Wd 2010>0

GS2535 // NEW //
FRONT WHEEL SENSOR (RIGHT SIDE)
REPLACES / REEMPLAZA:
Toyota: 8954233030, 8954207010, 8954207020

APPLICATION / APLICACIÓN:
TOYOTA: Camry 2.2 1997>0, Camry 2.2 1996>0, Camry 3.0 24V 1996>0, Camry 3.0 V6 1996>0

GS2537 // NEW //
REAR WHEEL SENSOR (LEFT SIDE)
REPLACES / REEMPLAZA:
Toyota: 8954632030, 8954633020; **A.B.S.:** 31021

APPLICATION / APLICACIÓN:
TOYOTA: Camry 2.2 1997>0, Camry 2.2 1996>0, Camry 3.0 24V 1996>0, Camry 3.0 V6 1996>0

GS2538 // NEW //
REAR WHEEL SENSOR (RIGHT SIDE)
REPLACES / REEMPLAZA:
Lexus: 8954533020; **A.B.S.:** 31022

APPLICATION / APLICACIÓN:
TOYOTA: Camry 2.2 1997>0, Camry 2.2 1996>0, Camry 3.0 24V 1996>0, Camry 3.0 V6 1996>0

GS2539 // NEW //
FRONT WHEEL SENSOR (RIGHT SIDE)
REPLACES / REEMPLAZA:
Toyota: 895420210, 8954202030, 8954212040;

A.B.S.: 31030

APPLICATION / APLICACIÓN:
TOYOTA: Corolla 1.4 1997>0, Corolla 1.4 16V 2000>0, Corolla 1.6 1997>0, Corolla 1.6 16V 1999>0, Corolla 1.6 Aut. 1997>0, Corolla 1.8 1997>0, Corolla 1.9 D 2000>0, Corolla 2.0 D 1997>0, Corolla 2.0 D-4D 2000>0, Corolla Box 2.0 D4D 2000>0, Corolla Compact 1.4 1997>0, Corolla Compact 1.4 1999>0, Corolla Compact 1.6 1997>0, Corolla Compact 1.6 1999>0, Corolla Compact 1.6 Aut. 1997>0, Corolla Compact 1.9 D 2000>0, Corolla Compact 2.0 D 1997>0, Corolla Compact 2.0 D-4D 2000>0, Corolla Estate 1.4 1997>0, Corolla Estate 1.4 16V 2000>0, Corolla Estate 1.6 1997>0, Corolla Estate 1.6 16V 1999>0, Corolla Estate 1.6 Aut. 1997>0, Corolla Estate 1.8 1997>0, Corolla Estate 1.8 4Wd 1997>0, Corolla Estate 1.9 D 2000>0, Corolla Estate 2.0 D 1997>0, Corolla Estate 2.0 D-4D 2000>0, Corolla Liftback 1.4 1997>0, Corolla Liftback 1.4 1999>0, Corolla Liftback 1.6 1997>0, Corolla Liftback 1.6 1999>0, Corolla Liftback 1.6 Aut. 1997>0, Corolla Liftback 1.9 D 2000>0, Corolla Liftback 2.0 D 1997>0, Corolla Liftback 2.0 D-4D 2000>0, Tercel Hatchback 1.3 1994>0

GS2540 // NEW //
FRONT WHEEL SENSOR (LEFT SIDE)

REPLACES / REEMPLAZA:

Toyota: 8954302010, 8954302030, 8954312040;

A.B.S.: 31029; **Delphi:** SS20288

APPLICATION / APLICACIÓN:

TOYOTA: Corolla 1.6 1994>0, Corolla 1.3 1997>0, Corolla 1.4 1997>0, Corolla 1.4 16V 2000>0, Corolla 1.6 1997>0, Corolla 1.6 16V 1999>0, Corolla 1.6 Aut. 1997>0, Corolla 1.8 1998>0, Corolla 1.8 1997>0, Corolla 1.9 D 2000>0, Corolla 2.0 D 1997>0, Corolla 2.0 D-4D 2000>0, Corolla 2.2 Td 1998>0, Corolla Box 2.0 D4D 2000>0, Corolla Compact 1.6 I 1994>0, Corolla Compact 1.4 1997>0, Corolla Compact 1.4 1999>0, Corolla Compact 1.6 1997>0, Corolla Compact 1.6 1999>0, Corolla Compact 1.6 Aut. 1997>0, Corolla Compact 1.9 D 2000>0, Corolla Compact 2.0 D 1997>0, Corolla Compact 2.0 D-4D 1997>0, Corolla Compact 2.0 D-4D 2000>0, Corolla Compact 2.2 Td 1998>0, Corolla Estate 1.4 1997>0, Corolla Estate 1.4 16V 2000>0, Corolla Estate 1.6 1997>0, Corolla Estate 1.6 16V 1999>0, Corolla Estate 1.6 Aut. 1997>0, Corolla Estate 1.8 1997>0, Corolla Estate 1.8 4Wd 1997>0, Corolla Estate 1.9 D 2000>0, Corolla Estate 2.0 D 1997>0, Corolla Estate 2.0 D-4D 1997>0, Corolla Estate 2.0 D-4D 2000>0, Corolla Liftback 1.4 1997>0, Corolla Liftback 1.4 1999>0, Corolla Liftback 1.6 1997>0, Corolla Liftback 1.6 1999>0, Corolla Liftback 1.6 Aut. 1997>0, Corolla Liftback 1.8 1998>0, Corolla Liftback 1.9 D 2000>0, Corolla Liftback 2.0 D 1997>0, Corolla Liftback 2.0 D-4D 2000>0

GS2543 // NEW //
REAR WHEEL SENSOR (LEFT SIDE)

REPLACES / REEMPLAZA:

Toyota: 895460K240

APPLICATION / APLICACIÓN:

TOYOTA: Hilux 2015>

GS2544 // NEW //
REAR WHEEL SENSOR (RIGHT SIDE)

REPLACES / REEMPLAZA:

Toyota: 895450K240

APPLICATION / APLICACIÓN:

TOYOTA: Hilux 2015>

GS2545 // NEW //
FRONT WHEEL SENSOR (LEFT SIDE)

REPLACES / REEMPLAZA:

Toyota: 895430K061

APPLICATION / APLICACIÓN:

TOYOTA: Hilux 2015>, Hilux SW4 2016>

GS2546 // NEW //
FRONT WHEEL SENSOR (RIGHT SIDE)

REPLACES / REEMPLAZA:

Toyota: 895420K060

APPLICATION / APLICACIÓN:

TOYOTA: Hilux 2015>, Hilux SW4 2016>

GS2547 // NEW //
REAR WHEEL SENSOR (RIGHT SIDE)

REPLACES / REEMPLAZA:

Toyota: 895450K130

APPLICATION / APLICACIÓN:

TOYOTA: Hilux SW4 2016>

GS2548 // NEW //
REAR WHEEL SENSOR (LEFT SIDE)

REPLACES / REEMPLAZA:

Toyota: 895460K130

APPLICATION / APLICACIÓN:

TOYOTA: Hilux SW4 2016>

GS2550 // NEW //
FRONT WHEEL SENSOR (RIGHT SIDE)

REPLACES / REEMPLAZA:

Toyota: 8954233090; **A.B.S.:** 31112

APPLICATION / APLICACIÓN:

LEXUS: Es 3.5 2006>0;

TOYOTA: Aurion 3.5 2006>0, Camry Saloon 2.4 2006>0, Camry Saloon 3.5 2006>0

GS2551 // NEW //
FRONT WHEEL SENSOR (RIGHT SIDE)

REPLACES / REEMPLAZA:

Toyota: 8954206010, 8954233070

APPLICATION / APLICACIÓN:

TOYOTA: Camry Sedan 2.4 2001>2006, Camry Sedan 3.0 2001>2006

GS2555 // NEW //
FRONT WHEEL SENSOR (RIGHT SIDE)

REPLACES / REEMPLAZA:

Toyota: 895420R010, 8954242050; **A.B.S.:** 31135;

Meat & Doria: 90577

APPLICATION / APLICACIÓN:

TOYOTA: Rav 4 Iii 2.0 2008>0, Rav 4 Iii 2.0 4Wd 2006>0, Rav 4 Iii 2.0 4Wd 2008>0, Rav 4 Iii 2.2 D 2008>0, Rav 4 Iii 2.2 D 4Wd 2006>0



GS2556 // NEW //

FRONT WHEEL SENSOR (LEFT SIDE)

REPLACES / REEMPLAZA:

Toyota: 8954342050; **A.B.S.:** 31044;

Meat & Doria: 90576

APPLICATION / APLICACIÓN:

TOYOTA: Rav 4 Iii 2.0 2008>0, Rav 4 Iii 2.0 4Wd 2006>0, Rav 4 Iii 2.0 4Wd 2008>0, Rav 4 Iii 2.2 D 2008>0, Rav 4 Iii 2.2 D 4Wd 2006>0



GS2557 // NEW //

REAR WHEEL SENSOR (RIGHT SIDE)

REPLACES / REEMPLAZA:

Toyota: 8954542040; **A.B.S.:** 31137

APPLICATION / APLICACIÓN:

TOYOTA: Rav 4 Iii 2.0 2009>0, Rav 4 Iii 2.0 2008>0, Rav 4 Iii 2.0 4Wd 2006>0, Rav 4 Iii 2.0 4Wd 2009>0, Rav 4 Iii 2.0 4Wd 2008>0, Rav 4 Iii 2.2 D 2008>0, Rav 4 Iii 2.2 D 4Wd 2005>0, Rav 4 Iii 2.2 D 4Wd 2006>0, Rav 4 Iii 2.4 2005>0, Rav 4 Iii 2.4 4Wd 2005>0



GS2558 // NEW //

FRONT AND REAR WHEEL SENSOR (RIGHT SIDE)

REPLACES / REEMPLAZA:

Toyota: 8954204020, 8954260050; **A.B.S.:** 31114

APPLICATION / APLICACIÓN:

LEXUS: Gx 470 2001>0, Gx 460 4Wd 2010>0, Lx 450D 2015>0, Lx 570 2007>0 **TOYOTA:** Fj Cruiser 4.0 2005>0, Fj Cruiser 4.0 4Wd 2005>0, Land Cruiser 200 4.5 D V8 2008>0, Land Cruiser 200 4.5 D4-D 2007>0, Land Cruiser 200 4.5 D4-D 2015>0, Land Cruiser 200 4.6 V8 2012>0, Land Cruiser 200 4.6 V8 2010>0, Land Cruiser 200 4.7 V8 2008>0, Land Cruiser Prado 2.7 2003>0, Land Cruiser Prado 3.0 D 2002>0, Land Cruiser Prado 3.0 D-4D 2002>0, Land Cruiser Prado 3.0 D-4D 2006>0, Land Cruiser Prado 4.0 2002>0, Land Cruiser Prado 4.0 V6 Vvt-I 2003>0, Land Cruiser Prado 2.7 2009>0, Land Cruiser Prado 2.8 D-4D 2018>0, Land Cruiser Prado 2.8 D-4D 2015>0, Land Cruiser Prado 3.0 D-4D 2009>0, Land Cruiser Prado 3.5 2015>0, Land Cruiser Prado 4.0 V6 Dual Vvti 2009>0, Land Cruiser Prado 4.0 V6 Vvti 2009>0, Land Cruiser Prado 4.0 V6 Vvti 2012>0, Land Cruiser Prado 4.0 V6 Vvt-I 2009>0, Land Cruiser Van 3.0 D4D 4Wd 2011>0



GS2559 // NEW //

FRONT AND REAR WHEEL SENSOR (LEFT SIDE)

REPLACES / REEMPLAZA:

Toyota: 8954304020, 8954360050; **A.B.S.:** 31113;

Meat & Doria: 90711

APPLICATION / APLICACIÓN:

LEXUS: Gx 470 2001>0, Gx 460 4Wd 2010>0, Lx 570 2007>0 **TOYOTA:** Fj Cruiser 4.0 4Wd 2005>0, Land Cruiser 200 4.5 D V8 2008>0, Land Cruiser 200 4.5 D4-D 2007>0, Land Cruiser 200 4.6 V8 2012>0, Land Cruiser 200 4.6 V8 2010>0, Land Cruiser 200 4.7 V8 2008>0, Land Cruiser Prado 3.0 D 2002>0, Land Cruiser Prado 3.0 D-4D 2002>0, Land Cruiser Prado 4.0 2002>0, Land Cruiser Prado 2.7 2009>0, Land Cruiser Prado 2.8 D-4D 2015>0, Land Cruiser Prado 3.0 D-4D 2009>0, Land Cruiser Prado 4.0 V6 Dual Vvti 2009>0, Land Cruiser Prado 4.0 V6 Vvt-I 2009>0



GS2560 // NEW //

FRONT WHEEL SENSOR (LEFT SIDE)

REPLACES / REEMPLAZA:

Toyota: 8954302040; **Bosch:** 0 265 006 676;

Delphi: SS20256; **A.B.S.:** 30766; **Meat & Doria:** 90565;

Mobiletron: AB-EU042

APPLICATION / APLICACIÓN:

TOYOTA: Avensis 1.6 Vvt-I 2003>0, Avensis 1.8 2003>0, Avensis 2.0 2003>0, Avensis 2.0 D-4D 2006>0, Avensis 2.0 D-4D 2003>0, Avensis 2.0 Vvti 2003>0, Avensis 2.2 D-4D 2005>0, Avensis 2.2 D-Cat 2005>0, Avensis 2.4 2003>0, Avensis Estate 1.6 Vvt-I 2003>0, Avensis Estate 1.8 2003>0, Avensis Estate 2.0 2003>0, Avensis Estate 2.0 D-4D 2006>0, Avensis Estate 2.0 D-4D 2003>0, Avensis Estate 2.0 Vvti 2003>0, Avensis Estate 2.2 D-4D 2005>0, Avensis Estate 2.2 D-Cat 2005>0, Avensis Estate 2.4 2003>0, Avensis Saloon 1.6 Vvt-I 2003>0, Avensis Saloon 1.8 2003>0, Avensis Saloon 2.0 2003>0, Avensis Saloon 2.0 D-4D 2006>0, Avensis Saloon 2.0 D-4D 2003>0, Avensis Saloon 2.0 Vvti 2003>0, Avensis Saloon 2.2 D-4D 2005>0, Avensis Saloon 2.2 D-Cat 2005>0, Avensis Saloon 2.4 2003>0, Corolla 1.8 Vvt-I Ts 2002>0, Corolla 1.8 Vvt-I Ts 2005>0, Corolla Estate 1.4 D4-D 2004>0, Corolla Estate 1.4 Vvt-I 2001>0, Corolla Estate 1.6 Vvt-I 2001>0, Corolla Estate 1.8 2001>0, Corolla Estate 1.8 Flex 2007>0, Corolla Estate 2.0 D-4D 2002>0, Corolla Saloon 1.4 D-4D 2004>0, Corolla Saloon 1.4 Vvt-I 2001>0, Corolla Saloon 1.6 Vvt-I 2001>0, Corolla Saloon 1.8 2001>0, Corolla Saloon 2.0 D-4D 2002>0, Corolla Saloon 1.8 Flex 2007>0, Corolla Saloon 1.8 Vvti 2006>0, Corolla Verso 1.6 2004>0, Corolla Verso 1.8 2004>0, Corolla Verso 2.0 D-4D 2004>0, Corolla Verso 2.2 D-4D 2005>0



GS2562 // NEW //

FRONT WHEEL SENSOR (RIGHT SIDE)

REPLACES / REEMPLAZA:

Toyota: 8954202040; **Bosch:** 0 265 006 677;

A.B.S.: 30548; **Delphi:** SS20255; **Meat & Doria:** 90566;

Mobiletron: AB-JP002

APPLICATION / APLICACIÓN:

TOYOTA: Avensis 1.6 Vvt-I 2003>0, Avensis 1.8 2003>0, Avensis 2.0 2003>0, Avensis 2.0 D-4D 2006>0, Avensis 2.0 D-4D 2003>0, Avensis 2.0 Vvti 2003>0, Avensis 2.2 D-4D 2005>0, Avensis 2.2 D-Cat 2005>0, Avensis 2.4 2003>0, Avensis Estate 1.6 Vvt-I 2003>0, Avensis Estate 1.8 2003>0, Avensis Estate 2.0 2003>0, Avensis Estate 2.0 D-4D 2006>0, Avensis Estate 2.0 D-4D 2003>0, Avensis Estate 2.0 Vvti 2003>0, Avensis Estate 2.2 D-4D 2005>0, Avensis Estate 2.2 D-Cat 2005>0, Avensis Estate 2.4 2003>0, Avensis Saloon 1.6 Vvt-I 2003>0, Avensis Saloon 1.8 2003>0, Avensis Saloon 2.0 2003>0, Avensis Saloon 2.0 D-4D 2006>0, Avensis Saloon 2.0 D-4D 2003>0, Avensis Saloon 2.0 Vvti 2003>0, Avensis Saloon 2.2 D-4D 2005>0, Avensis Saloon 2.2 D-Cat 2005>0, Avensis Saloon 2.4 2003>0, Corolla 1.8 Vvt-I Ts 2002>0, Corolla 1.8 Vvt-I Ts 2005>0, Corolla Estate 1.4 D4-D 2004>0, Corolla Estate 1.4 Vvt-I 2001>0, Corolla Estate 1.6 Vvt-I 2001>0, Corolla Estate 1.8 2001>0, Corolla Estate 1.8 Flex 2007>0, Corolla Estate 2.0 D-4D 2002>0, Corolla Saloon 1.4 D-4D 2004>0, Corolla Saloon 1.4 Vvt-I 2001>0, Corolla Saloon 1.6 Vvt-I 2001>0, Corolla Saloon 1.8 2001>0, Corolla Saloon 2.0 D-4D 2002>0, Corolla Saloon 1.8 Flex 2007>0, Corolla Saloon 1.8 Vvti 2006>0, Corolla Verso 1.6 2004>0, Corolla Verso 1.8 2004>0, Corolla Verso 2.0 D-4D 2004>0, Corolla Verso 2.2 D-4D 2005>0



GS2564 // NEW //

REAR WHEEL SENSOR (BOTH SIDES)

REPLACES / REEMPLAZA:

Peugeot: 4545A3, 0986594564

APPLICATION / APLICACIÓN:

PEUGEOT: 206 Cc 1.6 2001>0, 206 Cc 1.6 16V 2000>0, 206 Cc 1.6 Hdi 110 2004>0, 206 Cc 2.0 S16 1999>0, 206 Hatchback 1.4 16V 2003>0, 206 Hatchback 1.6 2001>0, 206 Hatchback 1.6 16V 2000>0, 206 Hatchback 1.6 8V 1999>0, 206 Hatchback 1.6 Flex 2005>0, 206 Hatchback 1.6 Hdi 110 2004>0, 206 Hatchback 2.0 Rc 2003>0, 206 Hatchback 2.0 S16 1999>0, 206 Saloon 1.6 16V 2000>0, 206 Sw 1.4 16V 2003>0, 206 Sw 1.6 2001>0, 206 Sw 1.6 16V 2000>0, 206 Sw 1.6 Flex 2005>0, 206 Sw 1.6 Hdi 110 2004>0, 206 Sw 1.6 Lpg 2002>0, 206 Sw 2.0 16V 2002>0, 206 Van 1.1 2002>0, 207 1.6 Flex 2005>0, 207 Saloon 1.6 Bioflex 2008>0, 207 Sw 1.6 Flex 2005>0



GS2568 // NEW //

FRONT WHEEL SENSOR (RIGHT SIDE)

REPLACES / REEMPLAZA:

Toyota: 895420K020; **A.B.S.:** 31329

APPLICATION / APLICACIÓN:

TOYOTA: Hilux Vii Pickup 2.5 D 4Wd 2005>0, Hilux Vii Pickup 2.5 D-4D 2010>0, Hilux Vii Pickup 2.5 D-4D 2005>0, Hilux Vii Pickup 2.5 D-4D 4Wd 2007>0, Hilux Vii Pickup 2.5 D-4D 4Wd 2006>0, Hilux Vii Pickup 3.0 D 4Wd 2005>0, Hilux Vii Pickup 3.0 D-4D 4Wd 2005>0

GS2569 // NEW //
FRONT WHEEL SENSOR (LEFT SIDE)

REPLACES / REEMPLAZA:

Toyota: 895430K020; **A.B.S.:** 31328

APPLICATION / APLICACIÓN:

TOYOTA: Hilux Vii Pickup 2.5 D 4Wd 2005>0, Hilux Vii Pickup 2.5 D-4D 2010>0, Hilux Vii Pickup 2.5 D-4D 4Wd 2007>0, Hilux Vii Pickup 2.5 D-4D 4Wd 2006>0, Hilux Vii Pickup 3.0 D-4D 4Wd 2005>0

GS2572 // NEW //
FRONT WHEEL SENSOR (RIGHT SIDE)

REPLACES / REEMPLAZA:

Toyota: 8954242040; **A.B.S.:** 31168

APPLICATION / APLICACIÓN:

TOYOTA: Rav 4 li 1.8 2000>0, Rav 4 li 2.0 4Wd 2000>0, Rav 4 li 2.0 D 4Wd 2001>0, Rav 4 li 2.4 4Wd 2003>0

GS2573 // NEW //
FRONT WHEEL SENSOR (LEFT SIDE)

REPLACES / REEMPLAZA:

Toyota: 8954342040

APPLICATION / APLICACIÓN:

TOYOTA: Rav 4 li 1.8 2000>0, Rav 4 li 2.0 4Wd 2000>0, Rav 4 li 2.0 D 4Wd 2001>0, Rav 4 li 2.4 4Wd 2003>0

GS2574 // NEW //
REAR WHEEL SENSOR (LEFT SIDE)

REPLACES / REEMPLAZA:

Toyota: 8954642030; **A.B.S.:** 31042

APPLICATION / APLICACIÓN:

TOYOTA: Rav 4 li 1.8 2000>0, Rav 4 li 2.0 4Wd 2000>0, Rav 4 li 2.0 D 4Wd 2001>0, Rav 4 li 2.4 4Wd 2003>0

GS2575 // NEW //
REAR WHEEL SENSOR (RIGHT SIDE)

REPLACES / REEMPLAZA:

Toyota: 8954542030; **A.B.S.:** 31043

APPLICATION / APLICACIÓN:

TOYOTA: Rav 4 li 1.8 2000>0, Rav 4 li 2.0 4Wd 2000>0, Rav 4 li 2.0 D 4Wd 2001>0, Rav 4 li 2.4 4Wd 2003>0

GS2576
FRONT WHEEL SENSOR

REPLACES / REEMPLAZA:

Bosch: 0 986 594 022

Peugeot: 454576

APPLICATION / APLICACIÓN:

Peugeot: 206 hatch/SW/CC 1.0/1.4/1.6

GS2577
REAR WHEEL SENSOR

REPLACES / REEMPLAZA:

Peugeot: 454577, 454579

APPLICATION / APLICACIÓN:

Peugeot: 206 hatch/SW/CC 1.0/1.4/1.6

GS2580 // NEW //
FRONT WHEEL SENSOR (BOTH SIDES)

REPLACES / REEMPLAZA:

Suzuki: 5620081A40; **A.B.S.:** 31248

APPLICATION / APLICACIÓN:

SUZUKI: Jimny Closed Off-Road Vehicle 1.3 2004>0, Jimny Closed Off-Road Vehicle 1.3 16V 2001>0, Jimny Closed Off-Road Vehicle 1.3 16V 4Wd 2001>0, Jimny Closed Off-Road Vehicle 1.3 16V 4X4 2005>0, Jimny Closed Off-Road Vehicle 1.3 4Wd 2013>0, Jimny Open Off-Road Vehicle 1.3 2004>0, Jimny Open Off-Road Vehicle 1.3 4Wd 2013>0

GS2583 // NEW //
REAR WHEEL SENSOR (RIGHT SIDE)

REPLACES / REEMPLAZA:

Toyota: 895450K010; 895450K040; **A.B.S.:** 1758

APPLICATION / APLICACIÓN:

TOYOTA: Hilux 2004>2010

GS2584 // NEW //
REAR WHEEL SENSOR (LEFT SIDE)

REPLACES / REEMPLAZA:

Toyota: 895460K010, 895460K040; **A.B.S.:** 31748

APPLICATION / APLICACIÓN:

TOYOTA: Hilux Vii Pickup 2.5 D 4Wd 2005>0, Hilux Vii Pickup 2.5 D-4D 2005>0, Hilux Vii Pickup 2.5 D-4D 4Wd 2007>0, Hilux Vii Pickup 2.5 D-4D 4Wd 2006>0, Hilux Vii Pickup 3.0 D 4Wd 2005>0, Hilux Vii Pickup 3.0 D-4D 4Wd 2005>0

GS2585 // NEW //
REAR WHEEL SENSOR (LEFT SIDE)

REPLACES / REEMPLAZA:

Toyota: 8954660030; **A.B.S.:** 31494

APPLICATION / APLICACIÓN:

LEXUS: Lx 470 1998>0;

TOYOTA: Land Cruiser 100 4.2 Td 1998>0, Land Cruiser 100 4.7 2002>0, Land Cruiser 100 4.7 1998>0

GS2586 // NEW //
REAR WHEEL SENSOR (RIGHT SIDE)

REPLACES / REEMPLAZA:

Toyota: 8954560030; **A.B.S.:** 31495

APPLICATION / APLICACIÓN:

LEXUS: Lx 470 1998>0;

TOYOTA: Land Cruiser 100 4.2 Td 1998>0, Land Cruiser 100 4.7 2002>0, Land Cruiser 100 4.7 1998>0

GS2587 // NEW //
FRONT WHEEL SENSOR (LEFT SIDE)

REPLACES / REEMPLAZA:

Volvo: 30773738, 307737380, 9496961, 94969610; **A.B.S.:** 30231; **Delphi:** SS20115; **Meat & Doria:** 90384

APPLICATION / APLICACIÓN:

VOLVO: S60 I 2.0 T 1998>0, S60 I 2.3 T5 1999>0, S60 I 2.4 1999>0, S60 I 2.4 Bifuel 2001>0, S60 I 2.4 Cdi 2003>0, S60 I 2.4 D 2001>0, S60 I 2.4 D5 2001>0, S60 I 2.4 T 1999>0, S60 I 2.4 T Awd 2001>0, S60 I 2.4 T5 2004>0, S60 I 2.5 T 2001>0, S60 I 2.5 T Awd 2002>0, S60 I R 2.5 T Awd 2003>0, S60 I T5 2000>0, S80 I 2.0 1998>0, S80 I 2.0 T 1998>0, S80 I 2.3 R 2000>0, S80 I 2.4 1999>0, S80 I 2.4 Bifuel 2001>0, S80 I 2.4 D 2001>0, S80 I 2.4 D5 2001>0, S80 I 2.4 Ltp 2004>0, S80 I 2.4 T 1999>0, S80 I 2.4 T5 Awd 2000>0, S80 I 2.5 T 2001>0, S80 I 2.5 T Awd 2002>0, S80 I 2.5 Tdi 1999>0, S80 I 2.8 T6 1998>0, S80 I 2.9 1998>0, S80 I 3.0 2001>0, S80 I 3.0 T6 2001>0, V70 li 2.0 T 1998>0, V70 li 2.3 2000>0, V70 li 2.3 Awd 2000>0, V70 li 2.3 T5 1999>0, V70 li 2.4 1999>0, V70 li 2.4 Awd 2000>0, V70 li 2.4 Bifuel 2001>0, V70 li 2.4 Cdi 2003>0, V70 li 2.4 D 2001>0, V70 li 2.4 D5 2001>0, V70 li 2.4 D5 Awd 2002>0, V70 li 2.4 T 1999>0, V70 li 2.4 T Awd 2001>0, V70 li 2.4 T5 2004>0, V70 li 2.5 T 2001>0, V70 li 2.5 T Awd 2002>0, V70 li 2.5 Tdi 1999>0, V70 li R 2.5 T Awd 2003>0, Xc70 Cross Country 2.4 D5 Awd 2002>0, Xc70 Cross Country 2.4 D5 Xc Awd 2002>0, Xc70 Cross Country 2.4 T Xc Awd 1997>0, Xc70 Cross Country 2.5 T Xc Awd 2002>0

GS2589 // NEW //
REAR WHEEL SENSOR (LEFT SIDE)
REPLACES / REEMPLAZA:
Volvo: 30773744, 8634247, 30773742; **A.B.S.:** 30233; **Delphi:** SS20130; **Meat & Doria:** 90386;

Mobiletron: AB-EU210

APPLICATION / APLICACIÓN:
VOLVO: S60 I 2.0 T 1998>0, S60 I 2.3 T5 1999>0, S60 I 2.4 1999>0, S60 I 2.4 Bifuel 2001>0, S60 I 2.4 Cdi 2003>0, S60 I 2.4 D 2001>0, S60 I 2.4 D5 2001>0, S60 I 2.4 T 1999>0, S60 I 2.4 T Awd 2001>0, S60 I 2.4 T5 2004>0, S60 I 2.5 T 2001>0, S60 I 2.5 T Awd 2002>0, S60 I R 2.5 T Awd 2003>0, S60 I T5 2000>0, S80 I 2.0 1998>0, S80 I 2.0 T 1998>0, S80 I 2.3 R 2000>0, S80 I 2.4 1999>0, S80 I 2.4 Bifuel 2001>0, S80 I 2.4 D 2001>0, S80 I 2.4 D5 2001>0, S80 I 2.4 Ltp 2004>0, S80 I 2.4 T 1999>0, S80 I 2.4 T5 Awd 2000>0, S80 I 2.5 T 2001>0, S80 I 2.5 T Awd 2002>0, S80 I 2.5 Tdi 1999>0, S80 I 2.8 T6 1998>0, S80 I 2.9 1998>0, S80 I 3.0 2001>0, S80 I 3.0 T6 2001>0, V70 Ii 2.0 T 1998>0, V70 Ii 2.3 2000>0, V70 Ii 2.3 Awd 2000>0, V70 Ii 2.3 T5 1999>0, V70 Ii 2.4 1999>0, V70 Ii 2.4 Awd 2000>0, V70 Ii 2.4 Bifuel 2001>0, V70 Ii 2.4 Cdi 2003>0, V70 Ii 2.4 D 2001>0, V70 Ii 2.4 D5 2001>0, V70 Ii 2.4 D5 Awd 2002>0, V70 Ii 2.4 T 1999>0, V70 Ii 2.4 T Awd 2001>0, V70 Ii 2.4 T5 2004>0, V70 Ii 2.5 T 2001>0, V70 Ii 2.5 T Awd 2002>0, V70 Ii 2.5 Tdi 1999>0, V70 Ii R 2.5 T Awd 2003>0, Xc70 Cross Country 2.4 D5 Awd 2002>0, Xc70 Cross Country 2.4 D5 Xc Awd 2002>0, Xc70 Cross Country 2.4 T Xc Awd 1997>0, Xc70 Cross Country 2.5 T Xc Awd 2002>0

GS2590
REAR WHEEL SENSOR (LEFT SIDE)
REPLACES / REEMPLAZA:
Hyundai: 95670-2D000, 95670-2D050

APPLICATION / APLICACIÓN:
Hyundai: Elantra Mk3 hatch/saloon 1.6/1.8/2.0, Matrix MPV 1.6

PS: set of GS2150

GS2591 // NEW //
REAR WHEEL SENSOR (LEFT SIDE)
REPLACES / REEMPLAZA:
Suzuki: 5632079J00, 5632079J01; **A.B.S.:** 31015;

Meat & Doria: 90715

APPLICATION / APLICACIÓN:
FIAT: Sedici 1.6 16V 2006>0, Sedici 1.9 D Multijet 2006>0, Sedici 2.0 D Multijet 2006>0 **SUZUKI:** Sx4 1.5 2006>0, Sx4 1.5 Vvt 2010>0, Sx4 1.5 Vvti 2007>0, Sx4 1.6 Ddis 2007>0, Sx4 1.6 Vvt 2006>0, Sx4 1.9 Ddis 2006>0, Sx4 2.0 Ddis 2009>0, Sx4 Saloon 1.6 2007>0

GS2592 // NEW //
FRONT WHEEL SENSOR (LEFT SIDE)
REPLACES / REEMPLAZA:
Suzuki: 5622079J00, 5622079J10; **A.B.S.:** 31129;

Meat & Doria: 90713

APPLICATION / APLICACIÓN:
FIAT: Sedici 1.6 16V 2006>0, Sedici 1.6 16V 4X4 2006>0, Sedici 1.9 D Multijet 2006>0, Sedici 1.9 D Multijet 4X4 2006>0, Sedici 2.0 D Multijet 2006>0, Sedici 2.0 D Multijet 4X4 2006>0 **SUZUKI:** Sx4 1.5 2006>0, Sx4 1.5 Vvt 2010>0, Sx4 1.5 Vvt 4X4 2010>0, Sx4 1.6 Ddis 2007>0, Sx4 1.6 Vvt 2006>0, Sx4 1.6 Vvt 4X4 2006>0, Sx4 1.9 Ddis 2006>0, Sx4 1.9 Ddis 4X4 2006>0, Sx4 2.0 Ddis 2009>0, Sx4 2.0 Ddis 4X4 2009>0, Sx4 Saloon 1.6 2007>0, Sx4 Saloon 1.6 Awd 2007>0

GS2593
FRONT WHEEL SENSOR (LEFT SIDE)
REPLACES / REEMPLAZA:
Bosch: 0 265 006 593

Daewoo: 96283017

APPLICATION / APLICACIÓN:
Daewoo: Nubira Hatch/Saloon/Estate

PS: set of GS2594

GS2594
FRONT WHEEL SENSOR (RIGHT SIDE)
REPLACES / REEMPLAZA:
Bosch: 0 265 006 594

Daewoo: 96283018

APPLICATION / APLICACIÓN:
Daewoo: Nubira Hatch/Saloon/Estate

PS: set of GS2593

GS2595 // NEW //
FRONT WHEEL SENSOR (LEFT SIDE)
REPLACES / REEMPLAZA:
Mitsubishi: 4670A595; **Meat & Doria:** 90534

APPLICATION / APLICACIÓN:
MITSUBISHI: L200 Triton 2011>2015, Pajero Dakar 2011>2015, Pajero Sport II 3.0/3.2 2008>2009

PS: set of GS2596, GS2597 and GS2598

GS2596 // NEW //
FRONT WHEEL SENSOR (RIGHT SIDE)
REPLACES / REEMPLAZA:
Mitsubishi: 4670A596; **Meat & Doria:** 90535

APPLICATION / APLICACIÓN:
MITSUBISHI: L200 Triton 2011>2015, Pajero Dakar 2011>2015, Pajero Sport II 3.0/3.2 2008>2009

PS: set of GS2595, GS2597 and GS2598

GS2597 // NEW //
REAR WHEEL SENSOR (LEFT SIDE)
REPLACES / REEMPLAZA:
Mitsubishi: 4670A597; **Meat & Doria:** 90536

APPLICATION / APLICACIÓN:
MITSUBISHI: L200 Triton 2011>2015, Pajero Dakar 2011>2015, L200 Triton Platparam/Chassis 2.5 2007>2015

GS2598 // NEW //
REAR WHEEL SENSOR (RIGHT SIDE)
REPLACES / REEMPLAZA:
Mitsubishi: 4670A598; **Meat & Doria:** 90537

APPLICATION / APLICACIÓN:
MITSUBISHI: L200 Triton 2011>2015, Pajero Dakar 2011>2015, Pajero Sport II 3.0/3.2 2008>2009

PS: set of GS2595, GS2596 and GS2597

GS2599 // NEW //
FRONT WHEEL SENSOR (LEFT SIDE)
REPLACES / REEMPLAZA:
Toyota: 8954371010; **A.B.S.:** 31763

APPLICATION / APLICACIÓN:
TOYOTA: Hilux Vii Pickup 2.5 D-4D 2010>0, Hilux Vii Pickup 2.5 D-4D 4Wd 2007>0

GS2600 // NEW //
FRONT WHEEL SENSOR (RIGHT SIDE)

REPLACES / REEMPLAZA:

Toyota: 8954271010; **A.B.S.:** 31764

APPLICATION / APLICACIÓN:

TOYOTA: Hilux Vii Pickup 2.5 D-4D 2010>0, Hilux Vii Pickup 2.5 D-4D 4Wd 2007>0, Hilux Vii Pickup 3.0 D 4Wd 2005>0, Hilux Vii Pickup 3.0 D-4D 4Wd 2008>0

GS2601 // NEW //
REAR WHEEL SENSOR (RIGHT SIDE)

REPLACES / REEMPLAZA:

Toyota: 8954571020

APPLICATION / APLICACIÓN:

TOYOTA Hilux SW4 2011>2015

GS2602 // NEW //
REAR WHEEL SENSOR (LEFT SIDE)

REPLACES / REEMPLAZA:

Toyota: 8954671020

APPLICATION / APLICACIÓN:

TOYOTA Hilux SW4 2011>2015

GS2603 // NEW //
REAR WHEEL SENSOR (RIGHT SIDE)

REPLACES / REEMPLAZA:

Toyota: 895450K070; **A.B.S.:** 31745

APPLICATION / APLICACIÓN:

TOYOTA: Hilux Vii Pickup 2.5 D-4D 2010>0, Hilux Vii Pickup 2.5 D-4D 4Wd 2007>0, Hilux Vii Pickup 3.0 D 4Wd 2005>0, Hilux Vii Pickup 3.0 D-4D 4Wd 2008>0

GS2604 // NEW //
REAR WHEEL SENSOR (LEFT SIDE)

REPLACES / REEMPLAZA:

Toyota: 895460K070; **A.B.S.:** 31744

APPLICATION / APLICACIÓN:

TOYOTA: Hilux Vii Pickup 2.5 D-4D 2010>0, Hilux Vii Pickup 2.5 D-4D 4Wd 2007>0, Hilux Vii Pickup 3.0 D 4Wd 2005>0, Hilux Vii Pickup 3.0 D-4D 4Wd 2008>0

GS2607 // NEW //
REAR WHEEL SENSOR (RIGHT SIDE)

REPLACES / REEMPLAZA:

VW: 2H0927808A; **Meat & Doria:** 90952, 90952E

APPLICATION / APLICACIÓN:

VW: Amarok 2.0 Bitdi 2010>0, Amarok 2.0 Bitdi 4Motion 2010>0, Amarok 2.0 Tdi 2010>0, Amarok 2.0 Tdi 4Motion 2010>0, Amarok 2.0 Tsi 2010>0, Amarok 3.0 Tdi 4Motion 2016>0, Amarok Platparam/Chassis 2.0 Tdi 2010>0, Amarok Platparam/Chassis 2.0 Tdi 4Motion 2010>0

GS2608 // NEW //
REAR WHEEL SENSOR (RIGHT SIDE)

REPLACES / REEMPLAZA:

VW: 2H0927808A; **Meat & Doria:** 90952, 90952E

APPLICATION / APLICACIÓN:

VW: Amarok 2.0 Bitdi 2010>0, Amarok 2.0 Bitdi 4Motion 2010>0, Amarok 2.0 Tdi 2010>0, Amarok 2.0 Tdi 4Motion 2010>0, Amarok 2.0 Tsi 2010>0, Amarok 3.0 Tdi 4Motion 2016>0, Amarok Platparam/Chassis 2.0 Tdi 2010>0, Amarok Platparam/Chassis 2.0 Tdi 4Motion 2010>0

GS2609 // NEW //
REAR WHEEL SENSOR (RIGHT SIDE)

REPLACES / REEMPLAZA:

Mitsubishi: 4670B008

APPLICATION / APLICACIÓN:

MITSUBISHI: L-200 Triton 2000>

GS2610 // NEW //
REAR WHEEL SENSOR (LEFT SIDE)

REPLACES / REEMPLAZA:

Mitsubishi: 4670B007

APPLICATION / APLICACIÓN:

MITSUBISHI: L-200 Triton 2000>

GS2611 // NEW //
FRONT WHEEL SENSOR (RIGHT SIDE)

REPLACES / REEMPLAZA:

Mitsubishi: 4670B006

APPLICATION / APLICACIÓN:

MITSUBISHI: L-200 Triton 2000>

GS2612 // NEW //
FRONT WHEEL SENSOR (LEFT SIDE)

REPLACES / REEMPLAZA:

Mitsubishi: 4670B005

APPLICATION / APLICACIÓN:

MITSUBISHI: L-200 Triton 2000>

GS2613 // NEW //
REAR WHEEL SENSOR (LEFT SIDE)

REPLACES / REEMPLAZA:

Renault: 8200254687, 6040004542, 0265007583; **Bosch:** 0 265 007 583; **Delphi:** SS20150; **Meat & Doria:** 90245, 90245E; **Mobiletron:** AB-EU170

APPLICATION / APLICACIÓN:

DACIA: Logan 1.2 16V 2006>0, Logan 1.2 16V Lpg 2006>0, Logan 1.4 2004>0, Logan 1.4 Mpi Lpg 2006>0, Logan 1.5 Dci 2005>0, Logan 1.5 Dci 2006>0, Logan 1.5 Dci 2007>0, Logan 1.6 2004>0, Logan 1.6 16V 2006>0, Logan 1.6 Lpg 2004>0, Logan Express 1.4 2004>0, Logan Express 1.5 Dci 2009>0, Logan Express 1.6 2004>0, Logan Mcv 1.4 2004>0, Logan Mcv 1.5 Dci 2007>0, Logan Mcv 1.6 2004>0, Logan Mcv 1.6 16V 2007>0, Logan Mcv 1.6 16V Hi-Flex 2009>0, Logan Mcv 1.6 Bifuel 2008>0, Logan Pickup 1.6 16V 2010>0 **RENAULT:** Logan Express 1.5 Dci 2007>0, Logan Express 1.6 2004>0, Logan I 1.4 2004>0, Logan I 1.5 Dci 2007>0, Logan I 1.6 2004>0, Logan I 1.6 2007>0, Logan I 1.6 Flex 2007>0, Logan I Estate 1.4 2004>0, Logan I Estate 1.5 Dci 2007>0, Logan I Estate 1.6 2004>0, Logan I Estate 1.6 2007>0, Sandero/Stepway I 1.0 Hi-Flex 2007>0, Sandero/Stepway I 1.6 2004>0, Sandero/Stepway I 1.6 Flex 2007>0, Twingo I 1.2 1996>0, Twingo I 1.2 16V 2004>0, Twingo I 1.2 16V 2001>0, Twingo I 1.2 Lpg 2000>0, Twingo I Box 1.2 1997>0, Twingo I Box 1.2 1996>0

GS2614 // NEW //
REAR WHEEL SENSOR (BOTH SIDES)

REPLACES / REEMPLAZA:

Audi: 8D0927807, 986594005; **Bosch:** 0 986 594 005; **Delphi:** SS20038; **Cargo:** 181883; **Meat & Doria:** 90057; **Mobiletron:** AB-EU070

APPLICATION / APLICACIÓN:

AUDI: A4 1.6 1994>0, A4 1.8 1994>0, A4 1.8 T 1995>0, A4 1.9 Tdi 1995>0, A4 2.4 1995>0, A4 2.5 Tdi 1997>0, A4 2.6 1995>0, A4 2.8 1995>0, A4 Avant 1.6 1994>0, A4 Avant 1.8 1994>0, A4 Avant 1.8 T 1995>0, A4 Avant 1.9 Duo 1998>0, A4 Avant 1.9 Tdi 1995>0, A4 Avant 2.4 1995>0, A4 Avant 2.5 Tdi 1997>0, A4 Avant 2.6 1995>0, A4 Avant 2.8 1995>0

GS2617 // NEW //
REAR WHEEL SENSOR (RIGHT SIDE)

REPLACES / REEMPLAZA:

Fiat: 46545468; **Bosch:** 0 265 007 053

APPLICATION / APLICACIÓN:

FIAT: Palio Weekend 1.0 Rst 2000>0, Palio Weekend 1.2 2001>0, Palio Weekend 1.2 1999>0, Palio Weekend 1.2 1997>0, Palio Weekend 1.2 Ex 2002>0, Palio Weekend 1.2 Flex 2004>0, Palio Weekend 1.4 2005>0, Palio Weekend 1.4 Elx Flex 2005>0, Palio Weekend 1.4 Flex 2005>0, Palio Weekend 1.5 2002>0, Palio Weekend 1.5 Mpi 1.6 1998>0, Palio Weekend 1.6 2001>0, Palio Weekend 1.6 16V 1997>0, Palio Weekend 1.6 Flex 2010>0, Palio Weekend 1.8 2003>0, Palio Weekend 1.8 2007>0, Palio Weekend 1.8 Flex 2006>0, Palio Weekend 1.8 Flex 2005>0, Palio Weekend 1.9 D 2001>0, Palio Weekend 1.9 Jtd 2001>0, Palio Weekend 1.4 Flex 2010>0, Palio Weekend 1.6 2010>0, Palio Weekend 1.8 Flex 2010>0

GS2618 // NEW //
REAR WHEEL SENSOR (LEFT SIDE)

REPLACES / REEMPLAZA:

Fiat: 46545469; **Bosch:** 0 265 007 052

APPLICATION / APLICACIÓN:

FIAT: Palio Weekend 1.0 Rst 2000>0, Palio Weekend 1.2 2001>0, Palio Weekend 1.2 1999>0, Palio Weekend 1.2 1997>0, Palio Weekend 1.2 Ex 2002>0, Palio Weekend 1.2 Flex 2004>0, Palio Weekend 1.4 2005>0, Palio Weekend 1.4 Elx Flex 2005>0, Palio Weekend 1.4 Flex 2005>0, Palio Weekend 1.5 2002>0, Palio Weekend 1.5 Mpi 1.6 1998>0, Palio Weekend 1.6 2001>0, Palio Weekend 1.6 16V 1997>0, Palio Weekend 1.6 Flex 2010>0, Palio Weekend 1.8 2003>0, Palio Weekend 1.8 2007>0, Palio Weekend 1.8 Flex 2006>0, Palio Weekend 1.8 Flex 2005>0, Palio Weekend 1.9 D 2001>0, Palio Weekend 1.9 Jtd 2001>0, Palio Weekend 1.4 Flex 2010>0, Palio Weekend 1.6 2010>0, Palio Weekend 1.8 Flex 2010>0

GS2619 // NEW //
REAR WHEEL SENSOR (LEFT SIDE)

REPLACES / REEMPLAZA:

Fiat: 46809774; **Bosch:** 0 265 006 688; **A.B.S.:** 30659; **Meat & Doria:** 90268; **Mobiletron:** AB-EU517

APPLICATION / APLICACIÓN:

FIAT: Ducato Box 2.0 1994>0, Ducato Box 2.0 Jtd 2001>0, Ducato Box 2.5 Tdi 1994>0, Ducato Box 2.5 Tdi 4X4 1997>0, Ducato Box 2.8 D 1998>0, Ducato Box 2.8 D 4X4 1998>0, Ducato Box 2.8 Jtd 2000>0, Ducato Box 2.8 Jtd 4X4 2000>0, Ducato Box 2.8 Tdi 1997>0, Ducato Box 2.8 Tdi 4X4 1999>0, Ducato Box 2.0 Bipower 2002>0, Ducato Box 2.3 Jtd 2002>0, Ducato Box 2.8 Jtd Power 2004>0, Ducato Box 2.8 Td 2002>0, Ducato Box 130 Multijet 2,3 D 2011>0, Ducato Bus 2.0 Jtd 2001>0, Ducato Bus 2.0 Panorama/Combinato 1994>0, Ducato Bus 2.5 Tdi 4X4 1997>0, Ducato Bus 2.5 Tdi Panorama/Combinato 1994>0, Ducato Bus 2.8 D 1998>0, Ducato Bus 2.8 Jtd 2000>0, Ducato Bus 2.8 Jtd 4X4 2000>0, Ducato Bus 2.8 Tdi 1997>0, Ducato Bus 2.8 Tdi 4X4 1999>0, Ducato Bus 2.0 1994>0, Ducato Bus 2.0 Bipower 2002>0, Ducato Bus 2.3 Jtd 2002>0, Ducato Bus 2.8 Td 2002>0, Ducato Platform/Chassis 2.0 1994>0, Ducato Platform/Chassis 2.0 Jtd 2001>0, Ducato Platform/Chassis 2.5 Tdi 4X4 1997>0, Ducato Platform/Chassis 2.8 D 1998>0, Ducato Platform/Chassis 2.8 Jtd 2000>0, Ducato Platform/Chassis 2.8 Jtd 4X4 2000>0, Ducato Platform/Chassis 2.8 Tdi 1997>0, Ducato Platform/Chassis 2.3 Jtd 2002>0, Ducato Platform/Chassis 2.8 Jtd Power 2004>0

GS2620 // NEW //
REAR WHEEL SENSOR (RIGHT SIDE)

REPLACES / REEMPLAZA:

Fiat: 46809773; **Bosch:** 0 265 006 689; **A.B.S.:** 30660; **Meat & Doria:** 90269

APPLICATION / APLICACIÓN:

FIAT: Ducato Box 2.0 1994>0, Ducato Box 2.0 Jtd 2001>0, Ducato Box 2.5 Tdi 1994>0, Ducato Box 2.5 Tdi 4X4 1997>0, Ducato Box 2.8 D 1998>0, Ducato Box 2.8 D 4X4 1998>0, Ducato Box 2.8 Jtd 2000>0, Ducato Box 2.8 Jtd 4X4 2000>0, Ducato Box 2.8 Tdi 1997>0, Ducato Box 2.8 Tdi 4X4 1999>0, Ducato Box 2.0 Bipower 2002>0, Ducato Box 2.3 Jtd 2002>0, Ducato Box 2.8 Jtd Power 2004>0, Ducato Box 2.8 Td 2002>0, Ducato Box 130 Multijet 2,3 D 2011>0, Ducato Bus 2.0 Jtd 2001>0, Ducato Bus 2.0 Panorama/Combinato 1994>0, Ducato Bus 2.5 Tdi 4X4 1997>0, Ducato Bus 2.5 Tdi Panorama/Combinato 1994>0, Ducato Bus 2.8 D 1998>0, Ducato Bus 2.8 Jtd 2000>0, Ducato Bus 2.8 Jtd 4X4 2000>0, Ducato Bus 2.8 Tdi 1997>0, Ducato Bus 2.8 Tdi 4X4 1999>0, Ducato Bus 2.0 1994>0, Ducato Bus 2.0 Bipower 2002>0, Ducato Bus 2.3 Jtd 2002>0, Ducato Bus 2.8 Td 2002>0, Ducato Platform/Chassis 2.0 1994>0, Ducato Platform/Chassis 2.0 Jtd 2001>0, Ducato Platform/Chassis 2.5 Tdi 4X4 1997>0, Ducato Platform/Chassis 2.8 D 1998>0, Ducato Platform/Chassis 2.8 Jtd 2000>0, Ducato Platform/Chassis 2.8 Jtd 4X4 2000>0, Ducato Platform/Chassis 2.8 Tdi 1997>0, Ducato Platform/Chassis 2.3 Jtd 2002>0, Ducato Platform/Chassis 2.8 Jtd Power 2004>0

GS2621 // NEW //
REAR WHEEL SENSOR (RIGHT SIDE)

REPLACES / REEMPLAZA:

Fiat: 51739392

APPLICATION / APLICACIÓN:

FIAT: Idea Adventure 2011>, Attractive / Essence 2011>

GS2622 // NEW //
REAR WHEEL SENSOR (LEFT SIDE)

REPLACES / REEMPLAZA:

Fiat: 51739391

APPLICATION / APLICACIÓN:

FIAT: Idea Adventure 2011>, Attractive 2011>, Essence 2011>

GS2623 // NEW //
FRONT WHEEL SENSOR (LEFT SIDE)
REPLACES / REEMPLAZA:
Hyundai: 956702B100; **A.B.S.:** 31423;

Meat & Doria: 90938

APPLICATION / APLICACIÓN:
HYUNDAI: Santa Fé li 2.0 Crdi 4X4 2006>0, Santa Fé li 2.2 Crdi 2006>0, Santa Fé li 2.2 Crdi 4X4 2006>0, Santa Fé li 2.2 Crdi Gls 2006>0, Santa Fé li 2.2 Crdi Gls 4X4 2006>0, Santa Fé li 2.7 2006>0, Santa Fé li 2.7 4X4 2006>0, Santa Fé li 2.7 V6 Gls 2006>0, Santa Fé li 2.7 V6 Gls 4X4 2006>0

GS2624 // NEW //
FRONT WHEEL SENSOR (RIGHT SIDE)
REPLACES / REEMPLAZA:
Hyundai: 956712B100; **A.B.S.:** 31424;

Meat & Doria: 90939

APPLICATION / APLICACIÓN:
HYUNDAI: Santa Fé li 2.0 Crdi 4X4 2006>0, Santa Fé li 2.2 Crdi 2006>0, Santa Fé li 2.2 Crdi 4X4 2006>0, Santa Fé li 2.2 Crdi Gls 2006>0, Santa Fé li 2.2 Crdi Gls 4X4 2006>0, Santa Fé li 2.7 2006>0, Santa Fé li 2.7 4X4 2006>0, Santa Fé li 2.7 V6 Gls 2006>0, Santa Fé li 2.7 V6 Gls 4X4 2006>0

GS2627 // NEW //
FRONT WHEEL SENSOR (BOTH SIDES)
REPLACES / REEMPLAZA:
BMW: 34521182076; **Delphi:** SS10303;

Meat & Doria: 90087; **Mobiletron:** AB-EU144

APPLICATION / APLICACIÓN:
BMW: 7 725 Tds 1996>0, 7 728 I, II 1995>0, 7 728I X 1995>0, 7 730 D 1998>0, 7 730 I, II 1994>0, 7 735 I, II 1996>0, 7 740 D 1999>0, 7 740 I, II 1994>0, 7 750 I, II 1994>0

GS2628 // NEW //
REAR WHEEL SENSOR (BOTH SIDES)
REPLACES / REEMPLAZA:
BMW: 34521182077; **Delphi:** SS10304;

Meat & Doria: 90088; **Mobiletron:** AB-EU147

APPLICATION / APLICACIÓN:
BMW: 7 725 Tds 1996>0, 7 728 I, II 1995>0, 7 728I X 1995>0, 7 730 D 1998>0, 7 730 I, II 1994>0, 7 735 I, II 1996>0, 7 740 D 1999>0, 7 740 I, II 1994>0, 7 750 I, II 1994>0

GS2629 // NEW //
FRONT WHEEL SENSOR (BOTH SIDES)
REPLACES / REEMPLAZA:
Renault: 8200404460, 0986594603; **Bosch:** 0 986 594 603; **Delphi:** SS20294; **Meat & Doria:** 90191, 90191E; **Mobiletron:** AB-EU087

APPLICATION / APLICACIÓN:
RENAULT: Grand Scénic li 1.5 Dci 2003>0, Grand Scénic li 1.5 Dci 2004>0, Grand Scénic li 1.5 Dci 2005>0, Grand Scénic li 1.6 2003>0, Grand Scénic li 1.6 Flex 2006>0, Grand Scénic li 1.9 Dci 2002>0, Grand Scénic li 1.9 Dci 2003>0, Grand Scénic li 1.9 Dci 2004>0, Grand Scénic li 1.9 Dci 2005>0, Grand Scénic li 2.0 2003>0, Grand Scénic li 2.0 Dci 2005>0, Megane li 1.4 16V 2003>0, Megane li 1.4 16V 2002>0, Megane li 1.5 Dci 2003>0, Megane li 1.5 Dci 2002>0, Megane li 1.5 Dci 2007>0, Megane li 1.5 Dci 2005>0, Megane li 1.6 2003>0, Megane li 1.6 16V 2005>0, Megane li 1.6 16V 2002>0, Megane li 1.6 Bifuel 2003>0, Megane li 1.6 Flex-Fuel 2007>0, Megane li 1.9 Dci 2002>0, Megane li 2.0 2003>0, Megane li 2.0 16V 2002>0, Megane li 2.0 16V Turbo 2004>0, Megane li 2.0 Dci 2005>0, Megane li Box Body/Estate 1.5 Dci 2003>0, Megane li Box Body/Estate 1.5 Dci 2005>0, Megane li Box Body/Estate 1.6 2003>0, Megane li Box Body/Estate 1.9 Dci 2006>0, Megane li Coupú-Cabriolet 1.5 Dci 2007>0, Megane li Coupú-Cabriolet 1.5 Dci 2006>0, Megane li Coupú-Cabriolet 1.6 2003>0, Megane li Coupú-Cabriolet 1.6 16V 2005>0, Megane li Coupú-Cabriolet 1.9 Dci 2002>0, Megane li Coupú-Cabriolet 2.0 2003>0, Megane li Coupú-Cabriolet 2.0 16V Turbo 2004>0, Megane li Coupú-Cabriolet 2.0 Dci 2005>0, Megane li Estate 1.4 2003>0, Megane li Estate 1.5 Dci 2004>0, Megane li Estate 1.5 Dci 2003>0, Megane li Estate 1.5 Dci 2007>0, Megane li Estate 1.5 Dci 2005>0, Megane li Estate 1.6 2003>0, Megane li Estate 1.6 16V 2005>0, Megane li Estate 1.6 16V Hi-Flex 2008>0, Megane li Estate 1.6 Flex 2006>0, Megane li Estate 1.6 Flex 2006>0, Megane li Estate 1.6 Lpg 16V 2006>0, Megane li Estate 1.9 Dci 2002>0, Megane li Estate 2.0 2003>0, Megane li Estate 2.0 Dci 2005>0, Megane li Hatchback Van 1.5 Dci 2003>0, Megane li Saloon 1.4 2003>0, Megane li Saloon 1.5 Dci 2004>0, Megane li Saloon 1.5 Dci 2003>0, Megane li Saloon 1.5 Dci 2005>0, Megane li Saloon 1.6 2003>0, Megane li Saloon 1.6 16V 2006>0, Megane li Saloon 1.6 Hi-Flex 2005>0, Megane li Saloon 1.9 Dci 2002>0, Megane li Saloon 1.9 Dci 2003>0, Megane li Saloon 1.9 Dci 2005>0, Megane li Saloon 2.0 2003>0, Megane li Saloon 2.0 Dci 2005>0, Scénic li 1.4 2003>0, Scénic li 1.5 Dci 2003>0, Scénic li 1.5 Dci 2007>0, Scénic li 1.5 Dci 2005>0, Scénic li 1.6 2003>0, Scénic li 1.6 Bifuel 2003>0, Scénic li 1.6 Hi-Flex 2005>0, Scénic li 1.9 D 2006>0, Scénic li 1.9 Dci 2002>0, Scénic li 1.9 Dci 2003>0, Scénic li 1.9 Dci 2004>0, Scénic li 1.9 Dci 2005>0, Scénic li 1.9 Dci 130 2005>0, Scénic li 2.0 2003>0, Scénic li 2.0 16V Turbo 2004>0, Scénic li 2.0 Dci 2005>0

GS2630 // NEW //
REAR WHEEL SENSOR (BOTH SIDES)
REPLACES / REEMPLAZA:
Renault: 8200416683, 0986594604; **Bosch:** 0 986 594 604; **Delphi:** SS20573; **Cargo:** SS20573; **Meat & Doria:** 90192; **Mobiletron:** AB-EU168

APPLICATION / APLICACIÓN:
RENAULT: Grand Scénic li 1.5 Dci 2003>0, Grand Scénic li 1.5 Dci 2004>0, Grand Scénic li 1.5 Dci 2005>0, Grand Scénic li 1.6 2003>0, Grand Scénic li 1.6 Flex 2006>0, Grand Scénic li 1.9 Dci 2002>0, Grand Scénic li 1.9 Dci 2003>0, Grand Scénic li 1.9 Dci 2004>0, Grand Scénic li 1.9 Dci 2005>0, Grand Scénic li 2.0 2003>0, Grand Scénic li 2.0 Dci 2005>0, Megane li 1.4 16V 2003>0, Megane li 1.4 16V 2002>0, Megane li 1.5 Dci 2003>0, Megane li 1.5 Dci 2002>0, Megane li 1.5 Dci 2007>0, Megane li 1.5 Dci 2005>0, Megane li 1.6 2003>0, Megane li 1.6 16V 2005>0, Megane li 1.6 16V 2002>0, Megane li 1.6 Bifuel 2003>0, Megane li 1.6 Flex-Fuel 2007>0, Megane li 1.9 Dci 2002>0, Megane li 2.0 2003>0, Megane li 2.0 16V 2002>0, Megane li 2.0 16V Turbo 2004>0, Megane li 2.0 Dci 2005>0, Megane li 2.0 Renault Sport 2004>0, Megane li Box Body/Estate 1.5 Dci 2003>0, Megane li Box Body/Estate 1.5 Dci 2005>0, Megane li Box Body/Estate 1.6 2003>0, Megane li Box Body/Estate 1.9 Dci 2006>0, Megane li Coupú-Cabriolet 1.5 Dci 2007>0, Megane li Coupú-Cabriolet 1.5 Dci 2006>0, Megane li Coupú-Cabriolet 1.6 2003>0, Megane li Coupú-Cabriolet 1.6 16V 2005>0, Megane li Coupú-Cabriolet 1.9 Dci 2002>0, Megane li Coupú-Cabriolet 2.0 2003>0, Megane li Coupú-Cabriolet 2.0 16V Turbo 2004>0, Megane li Coupú-Cabriolet 2.0 Dci 2005>0, Megane li Estate 1.4 2003>0, Megane li Estate 1.5 Dci 2004>0, Megane li Estate 1.5 Dci 2003>0, Megane li Estate 1.5 Dci 2007>0, Megane li Estate 1.5 Dci 2005>0, Megane li Estate 1.6 2003>0, Megane li Estate 1.6 16V 2005>0, Megane li Estate 1.6 Flex 2006>0, Megane li Estate 1.6 Lpg 16V 2006>0, Megane li Estate 1.9 Dci 2002>0, Megane li Estate 2.0 2003>0, Megane li Estate 2.0 Dci 2005>0, Megane li Hatchback Van 1.5 Dci 2003>0, Megane li Saloon 1.4 2003>0, Megane li Saloon 1.5 Dci 2004>0, Megane li Saloon 1.5 Dci 2003>0, Megane li Saloon 1.5 Dci 2005>0, Megane li Saloon 1.6 2003>0, Megane li Saloon 1.6 16V 2006>0, Megane li Saloon 1.6 Hi-Flex 2005>0, Megane li Saloon 1.9 Dci 2002>0, Megane li Saloon 1.9 Dci 2003>0, Megane li Saloon 1.9 Dci 2005>0, Megane li Saloon 2.0 2003>0, Megane li Saloon 2.0 Dci 2005>0, Scénic li 1.4 2003>0, Scénic li 1.5 Dci 2003>0, Scénic li 1.5 Dci 2007>0, Scénic li 1.5 Dci 2005>0, Scénic li 1.6 2003>0, Scénic li 1.6 16V 2005>0, Scénic li 1.6 Bifuel 2003>0, Scénic li 1.6 Hi-Flex 2005>0, Scénic li 1.9 D 2006>0, Scénic li 1.9 Dci 2002>0, Scénic li 1.9 Dci 2003>0, Scénic li 1.9 Dci 2004>0, Scénic li 1.9 Dci 2005>0, Scénic li 1.9 Dci 130 2005>0, Scénic li 2.0 2003>0, Scénic li 2.0 16V Turbo 2004>0, Scénic li 2.0 Dci 2005>0

GS2631 // NEW //
REAR WHEEL SENSOR (LEFT SIDE)
REPLACES / REEMPLAZA:
Renault: 8200212693, 6040004808; **Bosch:** 0 265 007 534; **A.B.S.:** 30700; **Meat & Doria:** 901022

APPLICATION / APLICACIÓN:
RENAULT: Kangoo 1.2 1997>0, Kangoo 1.2 16V 2001>0, Kangoo 1.4 1997>0, Kangoo 1.5 Dci 2003>0, Kangoo 1.5 Dci 2001>0, Kangoo 1.5 Dci 2002>0, Kangoo 1.6 16V 2001>0, Kangoo 1.6 Bivalent 2005>0, Kangoo 1.6 Flex 2007>0, Kangoo 1.9 Dti 2000>0, Kangoo D 55 1.9 1997>0, Kangoo D 65 1.9 1997>0, Kangoo Express 1.0 2002>0, Kangoo Express 1.2 1997>0, Kangoo Express 1.2 16V 2001>0, Kangoo Express 1.4 1997>0, Kangoo Express 1.5 Dci 2003>0, Kangoo Express 1.5 Dci 2001>0, Kangoo Express 1.5 Dci 2005>0, Kangoo Express 1.5 Dci 2002>0, Kangoo Express 1.6 16V 2001>0, Kangoo Express 1.6 Bivalent 2005>0, Kangoo Express 1.6 Flex 2007>0, Kangoo Express 1.9 D 1999>0, Kangoo Express 1.9 Dci 2003>0, Kangoo Express 1.9 Dti 2000>0, Kangoo Express D 55 1.9 1997>0, Kangoo Express D 65 1.9 1997>0

GS2632 // NEW //

REAR WHEEL SENSOR (RIGHT SIDE)

REPLACES / REEMPLAZA:

Renault: 8200212696, 6040004809; **Bosch:** 0 265 007 533; **A.B.S.:** 30699; **Meat & Doria:** 901023

APPLICATION / APLICACIÓN:

RENAULT: Kangoo 1.2 1997>0, Kangoo 1.2 16V 2001>0, Kangoo 1.4 1997>0, Kangoo 1.5 Dci 2003>0, Kangoo 1.5 Dci 2001>0, Kangoo 1.5 Dci 2002>0, Kangoo 1.6 16V 2001>0, Kangoo 1.6 16V Bivalent 2005>0, Kangoo 1.6 Flex 2007>0, Kangoo 1.9 Dti 2000>0, Kangoo D 55 1.9 1997>0, Kangoo D 65 1.9 1997>0, Kangoo Express 1.0 2002>0, Kangoo Express 1.2 1997>0, Kangoo Express 1.2 16V 2001>0, Kangoo Express 1.4 1997>0, Kangoo Express 1.5 Dci 2003>0, Kangoo Express 1.5 Dci 2001>0, Kangoo Express 1.5 Dci 2005>0, Kangoo Express 1.5 Dci 2002>0, Kangoo Express 1.6 16V 2001>0, Kangoo Express 1.6 16V Bivalent 2005>0, Kangoo Express 1.6 Flex 2007>0, Kangoo Express 1.9 D 1999>0, Kangoo Express 1.9 Dci 2003>0, Kangoo Express 1.9 Dti 2000>0, Kangoo Express D 55 1.9 1997>0, Kangoo Express D 65 1.9 1997>0

GS2633 // NEW //

FRONT WHEEL SENSOR (RIGHT SIDE)

REPLACES / REEMPLAZA:

Hyundai: 9567125300; **A.B.S.:** 30603; **Delphi:** SS20164; **Meat & Doria:** 90223; **Mobiletron:** AB-KR008

APPLICATION / APLICACIÓN:

HYUNDAI: Accent li 1.3 2000>0, Accent li 1.5 1999>0, Accent li 1.5 Crdi 2002>0, Accent li 1.6 2002>0, Accent li Saloon 1.3 2000>0, Accent li Saloon 1.5 1999>0, Accent li Saloon 1.5 Crdi 2002>0, Accent li Saloon 1.6 2002>0

GS2634 // NEW //

FRONT WHEEL SENSOR (LEFT SIDE)

REPLACES / REEMPLAZA:

Hyundai: 9567125200; **A.B.S.:** 30634; **Delphi:** SS20240; **Meat & Doria:** 90222; **Mobiletron:** AB-KR021

APPLICATION / APLICACIÓN:

HYUNDAI: Accent li 1.3 2000>0, Accent li 1.5 1999>0, Accent li 1.5 Crdi 2002>0, Accent li 1.6 2002>0, Accent li Saloon 1.3 2000>0, Accent li Saloon 1.5 1999>0, Accent li Saloon 1.5 Crdi 2002>0, Accent li Saloon 1.6 2002>0

GS2635 // NEW //

REAR WHEEL SENSOR (RIGHT SIDE)

REPLACES / REEMPLAZA:

Hyundai: 9568125100; **A.B.S.:** 30758; **Delphi:** SS20199; **Meat & Doria:** 90225; **Mobiletron:** AB-KR017

APPLICATION / APLICACIÓN:

HYUNDAI: Accent li 1.3 2000>0, Accent li 1.5 1999>0, Accent li 1.5 Crdi 2002>0, Accent li 1.6 2002>0, Accent li Saloon 1.3 2000>0, Accent li Saloon 1.5 1999>0, Accent li Saloon 1.5 Crdi 2002>0, Accent li Saloon 1.6 2002>0

GS2636 // NEW //

REAR WHEEL SENSOR (RIGHT SIDE)

REPLACES / REEMPLAZA:

Mitsubishi: 4670A374, MR569288

APPLICATION / APLICACIÓN:

MITSUBISHI: Galant 2004>2011

GS2637 // NEW //

FRONT WHEEL SENSOR (LEFT SIDE)

REPLACES / REEMPLAZA:

Mitsubishi: 4670A371, MR569285

APPLICATION / APLICACIÓN:

MITSUBISHI: Galant Saloon 2.4 2003>0, Galant Saloon 3.8 2003>0, Galant Saloon 3.8 4Wd 2003>0

GS2638 // NEW //

FRONT WHEEL SENSOR (RIGHT SIDE)

REPLACES / REEMPLAZA:

Mitsubishi: MR569286, 4670A372

APPLICATION / APLICACIÓN:

MITSUBISHI: Galant Saloon 2.4 2003>0, Galant Saloon 3.8 2003>0, Galant Saloon 3.8 4Wd 2003>0

GS2641 // NEW //

REAR WHEEL SENSOR (RIGHT SIDE)

REPLACES / REEMPLAZA:

Nissan: 47900CA000, 47900CA00A; **A.B.S.:** 31073

APPLICATION / APLICACIÓN:

NISSAN: Murano I 3.5 4X4 2003>0

GS2642 // NEW //

REAR WHEEL SENSOR (LEFT SIDE)

REPLACES / REEMPLAZA:

Nissan: 47901CA000, 47901CA00A; **A.B.S.:** 31356

APPLICATION / APLICACIÓN:

NISSAN: Murano I 3.5 4X4 2003>0

GS2643 // NEW //

FRONT WHEEL SENSOR (RIGHT SIDE)

REPLACES / REEMPLAZA:

NISSAN: 47910CA000/ 47910CK000/ 50284520 MOBILETRON: AB-JP096

APPLICATION / APLICACIÓN:

NISSAN: Murano I 3.5 4X4 2003>0

GS2644 // NEW //

FRONT WHEEL SENSOR (LEFT SIDE)

REPLACES / REEMPLAZA:

Nissan: 47911CA000; **Mobiletron:** AB-JP095

APPLICATION / APLICACIÓN:

NISSAN: Murano I 3.5 4X4 2003>0

GS2649 // NEW //
FRONT WHEEL SENSOR (LEFT SIDE)

REPLACES / REEMPLAZA:

Nissan: 479112Y000

APPLICATION / APLICACIÓN:

NISSAN: Maxima / Maxima Qx V 3.0 V6 24V 2000>0

GS2650 // NEW //
REAR WHEEL SENSOR (BOTH SIDES)

REPLACES / REEMPLAZA:

Fiat: 52137653, 52050138

APPLICATION / APLICACIÓN:

Fiat: Mobi 2017>, Novo Palio 2012 > 2017, Novo Uno Fase 2 2016>

PS: set of GS2002

GS2651 // NEW //
FRONT WHEEL SENSOR (LEFT SIDE)

REPLACES / REEMPLAZA:

Toyota: 8954306010, 8954333070; **A.B.S.:** 31023;

Meat & Doria: 901070

APPLICATION / APLICACIÓN:

TOYOTA: Camry Saloon 2.0 2001>0, Camry Saloon 2.4 2001>0, Camry Saloon 3.0 2001>0

GS2654 // NEW //
FRONT WHEEL SENSOR (RIGHT SIDE)

REPLACES / REEMPLAZA:

Lexus: 895420E020, 895420E080, 8954248050;

A.B.S.: 31341

APPLICATION / APLICACIÓN:

LEXUS: Rx 270 2008>0, Rx 350 2009>0, Rx 350 Awd 2008>0, Rx 450H 2008>0, Rx 450H Awd 2008>0;

TOYOTA: Highlander / Kluger 3.5 Awd 2014>0

GS2655 // NEW //
FRONT WHEEL SENSOR (LEFT SIDE)

REPLACES / REEMPLAZA:

Lexus: 895430E020, 895430E080, 8954348030, 8954348050;

A.B.S.: 31340

APPLICATION / APLICACIÓN:

LEXUS: Rx 270 2008>0, Rx 350 2009>0, Rx 350 Awd 2008>0, Rx 450H 2008>0, Rx 450H Awd 2008>0;

TOYOTA: Highlander / Kluger 3.5 Awd 2014>0

GS2657 // NEW //
FRONT WHEEL SENSOR (LEFT SIDE)

REPLACES / REEMPLAZA:

Toyota: 895430C020

APPLICATION / APLICACIÓN:

TOYOTA: Sequoia 2008>2017

GS2658 // NEW //
REAR WHEEL SENSOR (BOTH SIDES)

REPLACES / REEMPLAZA:

Fiat: 51702279, 0265007503, 0265008049;

Meat & Doria: 90023, 90023E; **Mobiletron:** AB-EU462

APPLICATION / APLICACIÓN:

FIAT: Idea 1.2 16V 2004>0, Idea 1.3 D Multijet 2004>0, Idea 1.4 2003>0, Idea 1.4 16V 2003>0, Idea 1.9 Jtd 2004>0;

LANCIA: Musa 1.3 D Multijet 2004>0, Musa 1.4 2003>0, Musa 1.9 D Multijet 2004>0, Ypsilon 1.2 2003>0, Ypsilon 1.3 D Multijet 2004>0, Ypsilon 1.3 Jtd 2003>0, Ypsilon 1.4 2003>0, Ypsilon 1.4 16V 2003>0

GS2660 // NEW //
REAR WHEEL SENSOR (LEFT SIDE)

REPLACES / REEMPLAZA:

Nissan: 47901JL00A, 479011B1A, 0265008190, 0265008564

APPLICATION / APLICACIÓN:

INFINITI: Ex 35 2008>0, Ex 37 2007>0, G Coupe 37 2007>0;

NISSAN: 370 Z Coupe 3.7 2009>0, 370 Z Roadster 3.7 2009>0

GS2661 // NEW //
FRONT WHEEL SENSOR (BOTH SIDES)

REPLACES / REEMPLAZA:

Nissan: 479101NF0B, 47910JK500, 479101BU0A, 47910JCA0A, 0265008025

APPLICATION / APLICACIÓN:

INFINITI: G Convertible 37 2007>0, G Coupe 37 2007>0, G Saloon 35 X 2007>0, G Saloon 37 X 2008>0, Q60 Convertible 3.7 2009>0, Q60 Coupe 3.7 2009>0;

NISSAN: 370 Z Coupe 3.7 2009>0, 370 Z Coupe Nismo 3.7 2013>0, 370 Z Roadster 3.7 2009>0

GS2662 // NEW //
REAR WHEEL SENSOR (LEFT SIDE)

REPLACES / REEMPLAZA:

Fiat: 51798998, 51989980, 0265007135

APPLICATION / APLICACIÓN:

FIAT: Palio Adventure 2013>

GS2664 // NEW //
REAR WHEEL SENSOR (RIGHT SIDE)

REPLACES / REEMPLAZA:

Lexus: 8954530070; **A.B.S.:** 30928;

Meat & Doria: 901044

APPLICATION / APLICACIÓN:

LEXUS: Gs 300 2005>0, Gs 430 2005>0, Gs 450H 2006>0, Gs 460 2007>0, Is C 250 2005>0, Is li 200D 2010>0, Is li 220D 2005>0, Is li 250 2005>0, Is li F 2007>0, Lfa 4.8 2010>0, Ls 460 2006>0, Ls 460 4Wd 2006>0, Ls 460 Awd 2008>0, Ls 600H Awd 2007>0;

TOYOTA: Crown 3.0 2003>0, Mark X I 2.5 Vvti 2004>0

GS2665 // NEW //
REAR WHEEL SENSOR (LEFT SIDE)

REPLACES / REEMPLAZA:

Lexus: 8954630070; **A.B.S.:** 30927;

Meat & Doria: 901043

APPLICATION / APLICACIÓN:

LEXUS: Gs 300 2005>0, Gs 430 2005>0, Gs 450H 2006>0, Gs 460 2007>0, Is C 250 2005>0, Is li 200D 2010>0, Is li 220D 2005>0, Is li 250 2005>0, Is li F 2007>0, Lfa 4.8 2010>0, Ls 460 2006>0, Ls 460 4Wd 2006>0, Ls 460 Awd 2008>0, Ls 600H Awd 2007>0;

TOYOTA: Crown 3.0 2003>0, Mark X I 2.5 Vvti 2004>0



GS2666 // NEW //
FRONT WHEEL SENSOR (BOTH SIDES)
REPLACES / REEMPLAZA:
Citroën: 4545C8; **Bosch:** 0 265 007 666; **Meat & Doria:** 90593, 90593E; **Mobiletron:** AB-EU322

APPLICATION / APLICACIÓN:
CITROËN: Berlingo First Box 1.4 Bivalent 2002>0, Berlingo First Box 1.4 I 1999>0, Berlingo First Box 1.4 I 1996>0, Berlingo First Box 1.4 I Bivalent 2003>0, Berlingo First Box 1.6 16V 2000>0, Berlingo First Box 1.6 Hdi 75 2005>0, Berlingo First Box 1.6 Hdi 90 2005>0, Berlingo First Box 1.9 D 70 1999>0, Berlingo First Box 1.9 D 70 4Wd 1998>0, Berlingo First Box 2.0 Hdi 90 1999>0, Berlingo First Box 2.0 Hdi 90 4Wd 2000>0, Berlingo First Box Electric 1998>0, Berlingo First Mpv 1.1 I 1996>0, Berlingo First Mpv 1.4 2002>0, Berlingo First Mpv 1.4 Bivalent 2002>0, Berlingo First Mpv 1.4 I 1996>0, Berlingo First Mpv 1.4 I Bivalent 2003>0, Berlingo First Mpv 1.6 16V 2000>0, Berlingo First Mpv 1.6 Hdi 75 2005>0, Berlingo First Mpv 1.6 Hdi 90 2005>0, Berlingo First Mpv 1.9 D 1998>0, Berlingo First Mpv 1.9 D 4Wd 1998>0, Berlingo First Mpv 2.0 Hdi 4X4 2002>0, Berlingo First Mpv 2.0 Hdi 90 1999>0, Berlingo First Mpv Electric 1998>0 PEUGEOT: Partner Box 1.4 2002>0, Partner Box 1.4 Bifuel 2003>0, Partner Box 1.6 Hdi 75 2005>0, Partner Box 1.6 Hdi 90 2005>0, Partner Box 1.9 D 1996>0, Partner Box 1.9 D 4X4 2004>0, Partner Box 2.0 Hdi 2000>0, Partner Box 2.0 Hdi 4X4 2004>0, Partner Comspace 1.4 2002>0, Partner Comspace 1.6 16V 2000>0, Partner Comspace 1.6 Hdi 75 2005>0, Partner Comspace 1.6 Hdi 90 2005>0, Partner Comspace 1.9 D 4X4 2004>0, Partner Comspace 2.0 Hdi 2000>0, Partner Comspace 2.0 Hdi 4X4 2004>0, Partner Origin Box 1.6 Hdi 75 2005>0, Partner Platform/Chassis 1.6 2000>0, Partner Platform/Chassis 1.6 Hdi 75 2005>0, Partner Platform/Chassis 1.9 D 1996>0, Partner Tepee 1.6 Hdi 75 2008>0

GS2667 // NEW //
FRONT WHEEL SENSOR (BOTH SIDES)
REPLACES / REEMPLAZA:
Renault: 7700302428; **A.B.S.:** 30297

APPLICATION / APLICACIÓN:
RENAULT: Master Ii Box 1.9 Dci 80 2001>0, Master Ii Box 1.9 Dti 2000>0, Master Ii Box 2.2 Dci 90 2000>0, Master Ii Box 2.5 D 1998>0, Master Ii Box 2.5 Dci 120 2001>0, Master Ii Box 2.8 Dti 1998>0, Master Ii Bus 1.9 Dci 80 2001>0, Master Ii Bus 1.9 Dti 2000>0, Master Ii Bus 2.2 Dci 90 2000>0, Master Ii Bus 2.5 D 1998>0, Master Ii Bus 2.5 Dci 120 2001>0, Master Ii Bus 2.8 Dti 1998>0, Master Ii Platform/Chassis 2.2 Dci 90 2000>0, Master Ii Platform/Chassis 2.5 D 1998>0, Master Ii Platform/Chassis 2.5 Dci 120 2001>0, Master Ii Platform/Chassis 2.8 Dti 1998>0

GS2668
REPLACES / REEMPLAZA:
Dodge: 56028668AB, 56028668AE, 56028668AA, 56028668AD, 56028668AF

APPLICATION / APLICACIÓN:
Dodge: Durango, Ram 1500/2500 Pickup

GS2672 // NEW //
REAR WHEEL SENSOR (BOTH SIDES)
REPLACES / REEMPLAZA:
Honda: 57470T7W003; **A.B.S.:** 31789;

Metzger: 09001388

APPLICATION / APLICACIÓN:
HONDA: HR-V 1.5 2015>, HR-V 1.6 i-DTEC 2015>

PS: set of GS2281 and GS2270

GS2673
FRONT WHEEL SENSOR
REPLACES / REEMPLAZA:
Bosch: 0 265 006 673

Fiat: 46776188, 59232005

APPLICATION / APLICACIÓN:
Fiat: Ducato Minibus/Van/Flatbed

GS2680
FRONT WHEEL SENSOR
REPLACES / REEMPLAZA:
Peugeot: 4545F4, 454599

APPLICATION / APLICACIÓN:
Peugeot: 206 hatch/saloon/SW/convertible, Hoggar

GS2693 // NEW //
FRONT WHEEL SENSOR (BOTH SIDES)
REPLACES / REEMPLAZA:
Fiat: 0265007830, 0265007485, 51759509, 517795760, 46845597; **Delphi:** SS2032; **Meat & Doria:** 90019, 90078

APPLICATION / APLICACIÓN:
FIAT: Idea 1.2 16V 2004>, Idea 1.3 D Multijet 2004>, Idea 1.4 2003>, Idea 1.4 16V 2004>, Idea 1.9 Jtd 2004> LANCIA: Musa 1.3 D Multijet 2004>2012, Musa 1.4 2004>2012, Musa 1.9 D Multijet 2004>2012, Ypsilon 1.2 2003>2011, Ypsilon 1.3 D Multijet 2006>2011, Ypsilon 1.3 D Multijet (843.Axf11, 843.Axf1A, 843.Axm11,... 2006>2011, Ypsilon 1.3 Jtd 2003>2011, Ypsilon 1.4 2006>2011, Ypsilon 1.4 16V 2003>2011

GS2699 // NEW //
REAR WHEEL SENSOR (BOTH SIDES)
REPLACES / REEMPLAZA:
Fiat: 51918285

APPLICATION / APLICACIÓN:
FIAT Bravo Essence 2011>2016, Sporting 2011>2016

GS2700 // NEW //
FRONT WHEEL SENSOR (BOTH SIDES)
REPLACES / REEMPLAZA:
Peugeot: 454548, 96252846, 96183217, 96272628, 0265006205; **Bosch:** 0 265 006 205; **A.B.S.:** 30140; **Meat & Doria:** 90273; **Mobiletron:** AB-EU055

APPLICATION / APLICACIÓN:
PEUGEOT: 306 1.8 16V 1995>0, 406 1.6 1995>0, 406 1.8 1996>0, 406 1.8 16V 1995>0, 406 1.8 Bifuel 1999>0, 406 1.9 D 1996>0, 406 1.9 Td 1995>0, 406 2.0 1996>0, 406 2.0 16V 1995>0, 406 2.0 16V Hpi 2001>0, 406 2.0 Hdi 110 1998>0, 406 2.0 Hdi 90 1999>0, 406 2.0 Turbo 1996>0, 406 2.1 Td 12V 1996>0, 406 2.2 2000>0, 406 2.2 Hdi 2000>0, 406 3.0 1999>0, 406 3.0 24V 1996>0, 406 3.0 V6 1999>0, 406 Break 1.8 1996>0, 406 Break 1.8 16V 1995>0, 406 Break 1.9 D 1996>0, 406 Break 1.9 Td 1995>0, 406 Break 2.0 1996>0, 406 Break 2.0 16V 1995>0, 406 Break 2.0 16V Hpi 2001>0, 406 Break 2.0 Hdi 110 1998>0, 406 Break 2.0 Hdi 90 1999>0, 406 Break 2.0 Turbo 1996>0, 406 Break 2.1 Td 12V 1996>0, 406 Break 2.2 2000>0, 406 Break 2.2 Hdi 2000>0, 406 Break 3.0 24V 1996>0, 406 Break 3.0 V6 1999>0, 406 Coupe 1.8 1996>0, 406 Coupe 2.0 16V 1995>0, 406 Coupe 2.2 2000>0, 406 Coupe 2.2 Hdi 2000>0, 406 Coupe 3.0 24V 1996>0, 406 Coupe 3.0 V6 1999>0, 406 Coupe 3.0 V6 24V 1997>0

GS2701
FRONT WHEEL SENSOR
REPLACES / REEMPLAZA:
Kia: OK56A43701, OK56A43701A

APPLICATION / APLICACIÓN:
Kia: Sedona Mk1/Mk2 2.5/2.9, Carnival

GS2702
FRONT WHEEL SENSOR
REPLACES / REEMPLAZA:
Scania: 1428454, 1439666, 1530702, 1534528, 1545506, 1892056

APPLICATION / APLICACIÓN:
Scania

GS2704 // NEW //
FRONT WHEEL SENSOR (LEFT SIDE)
REPLACES / REEMPLAZA:
Jeep: 4683471AB, 4683471A, 4683471AD, 4683471AE, 4683471AF; **Delphi:** SS20398; **Meat & Doria:** 90342, 90342E; **Mobiletron:** AB-US002

APPLICATION / APLICACIÓN:
CHRYSLER: Voyager Iv 2.4 2000>0, Voyager Iv 2.5 Crd 2000>0, Voyager Iv 2.8 Crd 2004>0, Voyager Iv 3.0 1999>0, Voyager Iv 3.3 1999>0, Voyager Iv 3.3 Awd 2000>0, Voyager Iv 3.3 Flexfuel 2000>0, Voyager Iv 3.3 Flexfuel Awd 2000>0, Voyager Iv 3.8 2000>0, Voyager Iv 3.8 Awd 2000>0

GS2712 // NEW //
REAR WHEEL SENSOR (RIGHT SIDE)
REPLACES / REEMPLAZA:
Mercedes-Benz: 9065400217, A9065400217, 0265009339; **Bosch:** 0 265 009 339; **Meat & Doria:** 90703, 90703E; **Mobiletron:** B-EU548

APPLICATION / APLICACIÓN:

MERCEDES-BENZ: Sprinter 3,5-T Box 309 Cdi 2006>0, Sprinter 3,5-T Box 310 Cdi 2009>0, Sprinter 3,5-T Box 311 Cdi 2006>0, Sprinter 3,5-T Box 311 Cdi 4X4 2008>0, Sprinter 3,5-T Box 313 Cdi 2006>0, Sprinter 3,5-T Box 313 Cdi 4X4 2009>0, Sprinter 3,5-T Box 314 Cdi 2016>0, Sprinter 3,5-T Box 314 Cdi 4X4 2016>0, Sprinter 3,5-T Box 315 Cdi 2006>0, Sprinter 3,5-T Box 315 Cdi 2014>0, Sprinter 3,5-T Box 315 Cdi 4X4 2008>0, Sprinter 3,5-T Box 316 2008>0, Sprinter 3,5-T Box 316 Cdi 2009>0, Sprinter 3,5-T Box 316 Cdi 4X4 2009>0, Sprinter 3,5-T Box 316 Lgt 2008>0, Sprinter 3,5-T Box 316 NgT 2008>0, Sprinter 3,5-T Box 318 Cdi 2006>0, Sprinter 3,5-T Box 318 Cdi 4X4 2008>0, Sprinter 3,5-T Box 319 Cdi / Bluetec 2009>0, Sprinter 3,5-T Box 319 Cdi / Bluetec 4X4 2009>0, Sprinter 3,5-T Box 324 2006>0, Sprinter 3,5-T Bus 310 Cdi 2009>0, Sprinter 3,5-T Bus 311 Cdi 2006>0, Sprinter 3,5-T Bus 311 Cdi 4X4 2008>0, Sprinter 3,5-T Bus 313 Cdi 2011>0, Sprinter 3,5-T Bus 313 Cdi 4X4 2011>0, Sprinter 3,5-T Bus 314 Cdi 2016>0, Sprinter 3,5-T Bus 314 Cdi 4X4 2016>0, Sprinter 3,5-T Bus 315 Cdi 2006>0, Sprinter 3,5-T Bus 315 Cdi 4X4 2008>0, Sprinter 3,5-T Bus 316 Cdi 2011>0, Sprinter 3,5-T Bus 316 Cdi 4X4 2011>0, Sprinter 3,5-T Bus 316 Lgt 2008>0, Sprinter 3,5-T Bus 316 NgT 2009>0, Sprinter 3,5-T Bus 318 Cdi 2008>0, Sprinter 3,5-T Bus 318 Cdi 4X4 2008>0, Sprinter 3,5-T Bus 319 Cdi / Bluetec 2009>0, Sprinter 3,5-T Bus 319 Cdi / Bluetec 4X4 2009>0, Sprinter 3,5-T Bus 324 2006>0, Sprinter 3,5-T Platparam/Chassis 309 Cdi 2006>0, Sprinter 3,5-T Platparam/Chassis 310 Cdi 2009>0, Sprinter 3,5-T Platparam/Chassis 311 Cdi 2011>0, Sprinter 3,5-T Platparam/Chassis 311 Cdi 2006>0, Sprinter 3,5-T Platparam/Chassis 311 Cdi 4X4 2008>0, Sprinter 3,5-T Platparam/Chassis 313 Cdi 2006>0, Sprinter 3,5-T Platparam/Chassis 313 Cdi 4X4 2006>0, Sprinter 3,5-T Platparam/Chassis 314 Cdi 2016>0, Sprinter 3,5-T Platparam/Chassis 314 Cdi 4X4 2016>0, Sprinter 3,5-T Platparam/Chassis 315 Cdi 2006>0, Sprinter 3,5-T Platparam/Chassis 315 Cdi 4X4 2008>0, Sprinter 3,5-T Platparam/Chassis 316 2008>0, Sprinter 3,5-T Platparam/Chassis 316 Cdi 2009>0, Sprinter 3,5-T Platparam/Chassis 316 Cdi 4X4 2009>0, Sprinter 3,5-T Platparam/Chassis 316 Lgt 2008>0, Sprinter 3,5-T Platparam/Chassis 316 NgT 2008>0, Sprinter 3,5-T Platparam/Chassis 318 Cdi 2006>0, Sprinter 3,5-T Platparam/Chassis 318 Cdi 4X4 2008>0, Sprinter 3,5-T Platparam/Chassis 319 Cdi / Bluetec 2009>0, Sprinter 3,5-T Platparam/Chassis 319 Cdi / Bluetec 4X4 2011>0, Sprinter 3,5-T Platparam/Chassis 324 2006>0, Sprinter 3-T Box 209 Cdi 2006>0, Sprinter 3-T Box 210 Cdi 2009>0, Sprinter 3-T Box 211 Cdi 2006>0, Sprinter 3-T Box 213 Cdi 2006>0, Sprinter 3-T Box 214 Cdi 2016>0, Sprinter 3-T Box 215 Cdi 2006>0, Sprinter 3-T Box 216 2008>0, Sprinter 3-T Box 216 Cdi 2009>0, Sprinter 3-T Box 218 Cdi 2006>0, Sprinter 3-T Box 219 Cdi / Bluetec 2009>0, Sprinter 3-T Box 224 2006>0, Sprinter 3-T Bus 210 Cdi 2009>0, Sprinter 3-T Bus 211 Cdi 2006>0, Sprinter 3-T Bus 213 Cdi 2006>0, Sprinter 3-T Bus 214 Cdi 2016>0, Sprinter 3-T Bus 215 Cdi 2006>0, Sprinter 3-T Bus 216 2008>0, Sprinter 3-T Bus 216 Cdi 2006>0, Sprinter 3-T Bus 224 2006>0, Sprinter 3-T Platparam/Chassis 209 Cdi 2006>0, Sprinter 3-T Platparam/Chassis 210 Cdi 2009>0, Sprinter 3-T Platparam/Chassis 211 Cdi 2006>0, Sprinter 3-T Platparam/Chassis 213 Cdi 2006>0, Sprinter 3-T Platparam/Chassis 214 Cdi 2016>0, Sprinter 3-T Platparam/Chassis 215 Cdi 2006>0, Sprinter 3-T Platparam/Chassis 216 2008>0, Sprinter 3-T Platparam/Chassis 216 Cdi 2009>0, Sprinter 3-T Platparam/Chassis 218 Cdi 2006>0, Sprinter 3-T Platparam/Chassis 219 Cdi / Bluetec 2009>0, Sprinter 3-T Platparam/Chassis 224 2006>0, Sprinter 4,6-T Box 411 Cdi 2009>0, Sprinter 4,6-T Box 413 Cdi 2006>0, Sprinter 4,6-T Box 414 Cdi 2016>0, Sprinter 4,6-T Box 414 Cdi 4X4 2016>0, Sprinter 4,6-T Box 415 Cdi 2009>0, Sprinter 4,6-T Box 416 Cdi 2009>0, Sprinter 4,6-T Box 419 Cdi 2009>0, Sprinter 4,6-T Box 424 2006>0, Sprinter 4,6-T Bus 415 Cdi 2006>0, Sprinter 4,6-T Platparam/Chassis 411 Cdi 2009>0, Sprinter 4,6-T Platparam/Chassis 413 Cdi 2009>0, Sprinter 4,6-T Platparam/Chassis 414 Cdi 2016>0, Sprinter 4,6-T Platparam/Chassis 415 Cdi 2006>0, Sprinter 4,6-T Platparam/Chassis 416 Cdi 2009>0, Sprinter 4,6-T Platparam/Chassis 418 Cdi 2006>0, Sprinter 4,6-T Platparam/Chassis 419 Cdi 2009>0, Sprinter 4,6-T Platparam/Chassis 424 2006>0, Sprinter 4-T Platparam/Chassis 414 Cdi Rwd 2018>0, Sprinter 5-T Box 509 Cdi 2006>0, Sprinter 5-T Box 510 Cdi 2009>0, Sprinter 5-T Box 511 Cdi 2006>0, Sprinter 5-T Box 511 Cdi 4X4 2006>0, Sprinter 5-T Box 513 Cdi 2006>0, Sprinter 5-T Box 513 Cdi 4X4 2006>0, Sprinter 5-T Box 514 Cdi 2016>0, Sprinter 5-T Box 514 Cdi 4X4 2016>0, Sprinter 5-T Box 515 Cdi 2006>0, Sprinter 5-T Box 515 Cdi 2011>0, Sprinter 5-T Box 515 Cdi 4X4 2006>0, Sprinter 5-T Box 516 2009>0, Sprinter 5-T Box 516 Cdi 2009>0, Sprinter 5-T Box 516 Cdi 4X4 2006>0, Sprinter 5-T Box 518 Cdi 2006>0, Sprinter 5-T Box 518 Cdi 4X4 2006>0, Sprinter 5-T Box 519 Cdi / Bluetec 2009>0, Sprinter 5-T Box 519 Cdi / Bluetec 4X4 2009>0, Sprinter 5-T Platparam/Chassis 509 Cdi 2006>0, Sprinter 5-T Platparam/Chassis 510 Cdi 2009>0, Sprinter 5-T Platparam/Chassis 511 Cdi 2006>0, Sprinter 5-T Platparam/Chassis 511 Cdi 4X4 2006>0, Sprinter 5-T Platparam/Chassis 513 Cdi 2006>0, Sprinter 5-T Platparam/Chassis 513 Cdi 4X4 2011>0, Sprinter 5-T Platparam/Chassis 514 Cdi 2016>0, Sprinter 5-T Platparam/Chassis 514 Cdi 4X4 2016>0, Sprinter 5-T Platparam/Chassis 515 Cdi 2006>0, Sprinter 5-T Platparam/Chassis 515 Cdi 4X4 2006>0, Sprinter 5-T Platparam/Chassis 516 2008>0, Sprinter 5-T Platparam/Chassis 516 Cdi 2009>0, Sprinter 5-T Platparam/Chassis 516 Cdi 4X4 2011>0, Sprinter 5-T Platparam/Chassis 516 NgT 2008>0, Sprinter 5-T Platparam/Chassis 518 Cdi 2006>0, Sprinter 5-T Platparam/Chassis 518 Cdi 4X4 2006>0, Sprinter 5-T Platparam/Chassis 519 Cdi / Bluetec 2009>0, Sprinter 5-T Platparam/Chassis 519 Cdi / Bluetec 4X4 2009>0, Sprinter 5-T Platparam/Chassis 524 2006>0;

VW: Crafter 30-35 Bus 2.0 Tdi 2011>0, Crafter 30-35 Bus 2.0 Tdi 4Motion 2011>0, Crafter 30-35 Bus 2.5 Tdi 2006>0, Crafter 30-50 Box 2.0 Tdi 2011>0, Crafter 30-50 Box 2.0 Tdi 4Motion 2011>0, Crafter 30-50 Box 2.5 Tdi 2006>0, Crafter 30-50 Platparam/Chassis 2.0 Tdi 2011>0, Crafter 30-50 Platparam/Chassis 2.0 Tdi 4Motion 2011>0, Crafter 30-50 Platparam/Chassis 2.5 Tdi 2006>0

GS2713 // NEW //
REAR WHEEL SENSOR (BOTH SIDES)
REPLACES / REEMPLAZA:
Mercedes-Benz: 9015421117, A9015421117, A9015420319, A9015420319, 0265004010; **Bosch:** 0 265 004 010; **Meat & Doria:** 90198; **Mobiletron:** AB-EU325

APPLICATION / APLICACIÓN:

MERCEDES-BENZ: Sprinter 2-T Box 208 Cdi 2000>0, Sprinter 2-T Box 208 D 1995>0, Sprinter 2-T Box 210 D 1997>0, Sprinter 2-T Box 211 Cdi 2000>0, Sprinter 2-T Box 212 D 1995>0, Sprinter 2-T Box 213 Cdi 2000>0, Sprinter 2-T Box 214 1995>0, Sprinter 2-T Box 214 Ngd 1995>0, Sprinter 2-T Box 216 Cdi 2000>0, Sprinter 2-T Bus 208 Cdi 2000>0, Sprinter 2-T Bus 208 D 1995>0, Sprinter 2-T Bus 210 D 1997>0, Sprinter 2-T Bus 211 Cdi 2000>0, Sprinter 2-T Bus 212 D 1995>0, Sprinter 2-T Bus 213 Cdi 2000>0, Sprinter 2-T Bus 214 1995>0, Sprinter 2-T Bus 214 Ngd 1995>0, Sprinter 2-T Bus 216 Cdi 2000>0, Sprinter 2-T Platparam/Chassis 208 Cdi 2000>0, Sprinter 2-T Platparam/Chassis 208 D 1995>0, Sprinter 2-T Platparam/Chassis 210 D 1997>0, Sprinter 2-T Platparam/Chassis 211 Cdi 2000>0, Sprinter 2-T Platparam/Chassis 212 D 1995>0, Sprinter 2-T Platparam/Chassis 213 Cdi 2000>0, Sprinter 2-T Platparam/Chassis 214 1995>0, Sprinter 2-T Platparam/Chassis 214 Ngd 1995>0, Sprinter 2-T Platparam/Chassis 216 Cdi 2000>0, Sprinter 3-T Box 308 Cdi 2000>0, Sprinter 3-T Box 308 D 2.3 1995>0, Sprinter 3-T Box 310 D 2.9 1995>0, Sprinter 3-T Box 311 Cdi 2000>0, Sprinter 3-T Box 311 Cdi 4X4 2002>0, Sprinter 3-T Box 312 D 2.9 1995>0, Sprinter 3-T Box 312 D 2.9 4X4 1997>0, Sprinter 3-T Box 313 Cdi 2000>0, Sprinter 3-T Box 313 Cdi 4X4 2002>0, Sprinter 3-T Bus 308 Cdi 2000>0, Sprinter 3-T Bus 308 D 1995>0, Sprinter 3-T Bus 308 D 1997>0, Sprinter 3-T Bus 310 D 1997>0, Sprinter 3-T Bus 310 D 4X4 1997>0, Sprinter 3-T Bus 311 Cdi 2000>0, Sprinter 3-T Bus 311 Cdi 4X4 2002>0, Sprinter 3-T Bus 312 D 2.9 1995>0, Sprinter 3-T Bus 312 D 2.9 4X4 1997>0, Sprinter 3-T Bus 313 Cdi 2000>0, Sprinter 3-T Bus 313 Cdi 4X4 2002>0, Sprinter 3-T Bus 314 1995>0, Sprinter 3-T Bus 314 4X4 2002>0, Sprinter 3-T Bus 314 Ngd 1995>0, Sprinter 3-T Bus 316 Cdi 2000>0, Sprinter 3-T Platparam/Chassis 308 Cdi 2000>0, Sprinter 3-T Platparam/Chassis 308 D 2.3 1995>0, Sprinter 3-T Platparam/Chassis 310 D 2.9 1995>0, Sprinter 3-T Platparam/Chassis 311 Cdi 2000>0, Sprinter 3-T Platparam/Chassis 311 Cdi 4X4 2002>0, Sprinter 3-T Platparam/Chassis 312 D 2.9 1995>0, Sprinter 3-T Platparam/Chassis 312 D 2.9 1998>0, Sprinter 3-T Platparam/Chassis 313 Cdi 2000>0, Sprinter 3-T Platparam/Chassis 313 Cdi 4X4 2002>0, Sprinter 3-T Platparam/Chassis 314 1995>0, Sprinter 3-T Platparam/Chassis 314 4X4 2002>0, Sprinter 3-T Platparam/Chassis 314 Ngd 1995>0, Sprinter 3-T Platparam/Chassis 316 Cdi 2000>0, Sprinter 3-T Platparam/Chassis 316 Cdi 4X4 2002>0, Sprinter 4-T Box 408 Cdi 2000>0, Sprinter 4-T Box 408 D 1996>0, Sprinter 4-T Box 410 D 1996>0, Sprinter 4-T Box 410 D 4X4 1997>0, Sprinter 4-T Box 411 Cdi 2000>0, Sprinter 4-T Box 411 Cdi 4X4 2000>0, Sprinter 4-T Box 412 D 1996>0, Sprinter 4-T Box 412 D 4X4 1997>0, Sprinter 4-T Box 413 Cdi 2000>0, Sprinter 4-T Box 413 Cdi 4X4 2000>0, Sprinter 4-T Box 414 1996>0, Sprinter 4-T Box 414 4X4 1997>0, Sprinter 4-T Box 416 Cdi 2000>0, Sprinter 4-T Box 416 Cdi 4X4 2000>0, Sprinter 4-T Bus 408 Cdi 2000>0, Sprinter 4-T Bus 411 Cdi 2000>0, Sprinter 4-T Bus 413 Cdi 2000>0, Sprinter 4-T Bus 414 1996>0, Sprinter 4-T Bus 416 Cdi 2000>0, Sprinter 4-T Platparam/Chassis 408 Cdi 2000>0, Sprinter 4-T Platparam/Chassis 408 D 1996>0, Sprinter 4-T Platparam/Chassis 410 D 1996>0, Sprinter 4-T Platparam/Chassis 410 D 4X4 1997>0, Sprinter 4-T Platparam/Chassis 411 Cdi 2000>0, Sprinter 4-T Platparam/Chassis 411 Cdi 4X4 2000>0, Sprinter 4-T Platparam/Chassis 412 D 1996>0, Sprinter 4-T Platparam/Chassis 412 D 4X4 1997>0, Sprinter 4-T Platparam/Chassis 413 Cdi 2000>0, Sprinter 4-T Platparam/Chassis 413 Cdi 4X4 2000>0, Sprinter 4-T Platparam/Chassis 414 1995>0, Sprinter 4-T Platparam/Chassis 414 4X4 1997>0, Sprinter 4-T Platparam/Chassis 416 Cdi 2000>0, Sprinter 4-T Platparam/Chassis 416 Cdi 4X4 2000>0, Sprinter 5-T Platparam/Chassis 616 Cdi 2001>0, Sprinter Dump Truck 616 Cdi 2001>0;

VW: Lt 28-35 li Bus 2.3 1996>0, Lt 28-35 li Bus 2.5 Sdi 1996>0, Lt 28-35 li Bus 2.8 Tdi 1997>0, Lt 28-46 li Box 2.3 1996>0, Lt 28-46 li Box 2.5 Sdi 1996>0, Lt 28-46 li Box 2.5 Tdi 1996>0, Lt 28-46 li Box 2.8 Tdi 1997>0, Lt 28-46 li Platparam/Chassis 2.3 1996>0, Lt 28-46 li Platparam/Chassis 2.5 Sdi 1996>0, Lt 28-46 li Platparam/Chassis 2.5 Tdi 1996>0, Lt 28-46 li Platparam/Chassis 2.8 Tdi 1997>0

GS2716 // NEW //
REAR WHEEL SENSOR (RIGHT SIDE)
REPLACES / REEMPLAZA:
Kia: 956812S500; **A.B.S.:** 31084; **Meat & Doria:** 90832, 90832E

APPLICATION / APLICACIÓN:

HYUNDAI: Ix35 2.0 2010>0, Ix35 2.0 4Wd 2010>0, Ix35 2.0 Crdi 2010>0, Ix35 2.0 Crdi 4Wd 2010>0, Ix35 2.0 Gdi 2013>0, Ix35 2.0 Gdi 4Wd 2013>0 KIA: Sportage 2.0 Crdi 2010>0, Sportage 2.0 Crdi Awd 2010>0, Sportage 2.0 Cvvt 2010>0, Sportage 2.0 Cvvt Awd 2010>0, Sportage 2.0 Gdi 2013>0, Sportage 2.0 Gdi Awd 2014>0

GS2717 // NEW //
REAR WHEEL SENSOR (RIGHT SIDE)
REPLACES / REEMPLAZA:
Kia: 956812S300; **A.B.S.:** 31066; **Meat & Doria:** 90377

APPLICATION / APLICACIÓN:

HYUNDAI: Ix35 1.6 2010>0, Ix35 1.7 Crdi 2010>0, Ix35 2.0 2010>0, Ix35 2.0 4Wd 2010>0, Ix35 2.0 Crdi 2010>0, Ix35 2.0 Crdi 4Wd 2010>0;

Kia: Sportage 1.6 Gdi 2011>0, Sportage 1.7 Crdi 2010>0, Sportage 2.0 Crdi 2010>0, Sportage 2.0 Cvvt 2010>0, Sportage 2.0 Gdi 2014>0

GS2720 // NEW //
REAR WHEEL SENSOR (LEFT SIDE)
REPLACES / REEMPLAZA:
Subaru: 27540SG031; **Bosch:** 0 265 009 454; **Meat & Doria:** 90812

APPLICATION / APLICACIÓN:

SUBARU: Forester 2.0 Awd 2012>0, Forester 2.0 Bifuel Awd 2013>0, Forester 2.0 D Awd 2012>0, Forester 2.0 I Awd 2012>0, Forester 2.0 Xt Awd 2013>0, Forester 2.5 Awd 2014>0, Xv 1.6 Bifuel Awd 2012>0, Xv 1.6 I Awd 2012>0, Xv 2.0 Bifuel Awd 2012>0, Xv 2.0 D Awd 2012>0, Xv 2.0 I Awd 2012>0

GS2721 // NEW //
FRONT WHEEL SENSOR (BOTH SIDES)
REPLACES / REEMPLAZA:
BMW: 34520025721, 34521165532, 34526756373; **Meat & Doria:** 90076; **Mobiletron:** AB-EU189

APPLICATION / APLICACIÓN:

BMW: 7 725 Tds 1996>0, 7 728 I, II 1995>0, 7 728 I X 1995>0, 7 730 D 1998>0, 7 730 I, II 1994>0, 7 735 I, II 1998>0, 7 740 D 1999>0, 7 740 I, II 1996>0, 7 750 I, II 1994>0

GS2722
REAR WHEEL SENSOR (RIGHT SIDE)
REPLACES / REEMPLAZA:
Jeep: 56027722, 56026930

APPLICATION / APLICACIÓN:
Jeep: Cherokee 4.0, Grand Cherokee Mk1 2.5/4.0/5.2/5.9

PS: set of GS2723

GS2723
REAR WHEEL SENSOR (LEFT SIDE)
REPLACES / REEMPLAZA:
Jeep: 56027723, 56026931

APPLICATION / APLICACIÓN:
Jeep: Cherokee 4.0, Grand Cherokee Mk1 2.5/4.0/5.2/5.9

PS: set of GS2722

GS2725

FRONT WHEEL SENSOR (LEFT SIDE)

REPLACES / REEMPLAZA:
 Nissan: 479115Y700, 479115Y705
APPLICATION / APLICACIÓN:
 Nissan: Maxima 2002>2003
PS: set of GS2284

GS2731

FRONT WHEEL SENSOR (BOTH SIDES)

REPLACES / REEMPLAZA:
 Bosch: 0 265 008 731
 Chevrolet: 94749256
APPLICATION / APLICACIÓN:
 Chevrolet: S10 2.8

GS2733

FRONT WHEEL SENSOR (BOTH SIDES)

REPLACES / REEMPLAZA:
 Bosch: 0 265 008 733
 Chevrolet: 94749255
APPLICATION / APLICACIÓN:
 Chevrolet: S10 2.8

GS2735 // NEW //

REAR WHEEL SENSOR (RIGHT SIDE)

REPLACES / REEMPLAZA:
 Hyundai: 956812B000; **A.B.S.:** 30888;
 Meat & Doria: 90500
APPLICATION / APLICACIÓN:
HYUNDAI: Santa Fé li 2.0 Crdi 2010>0, Santa Fé li 2.0 Crdi 4X4 2010>0, Santa Fé li 2.2 Crdi 2006>0, Santa Fé li 2.2 Crdi 4X4 2006>0, Santa Fé li 2.2 Crdi Gls 2006>0, Santa Fé li 2.2 Crdi Gls 4X4 2006>0, Santa Fé li 2.4 2010>0, Santa Fé li 2.4 4X4 2010>0, Santa Fé li 2.7 V6 Gls 2006>0, Santa Fé li 2.7 V6 Gls 4X4 2006>0

GS2741

REAR WHEEL SENSOR (LEFT SIDE)

REPLACES / REEMPLAZA:
 Renault: 7700834761
APPLICATION / APLICACIÓN:
 Renault: Megane Mk1 hatch /estate/coupe, Scenic
PS: set of GS2742

GS2742

FRONT WHEEL SENSOR (RIGHT SIDE)

REPLACES / REEMPLAZA:
 Renault: 7700834762
APPLICATION / APLICACIÓN:
 Renault: Megane Mk1 hatch /estate/coupe, Scenic
PS: set of GS2741

GS2746 // NEW //

REAR WHEEL SENSOR (BOTH SIDES)

REPLACES / REEMPLAZA:
 Renault: 7700411746, 7700415683; **Bosch:** 0 265 006 385;
A.B.S.: 30472; **Mobiltron:** AB-EU347
APPLICATION / APLICACIÓN:
RENAULT: Clio li 1.0 2000>0, Clio li 1.2 1998>0, Clio li 1.2 16V 2001>0, Clio li 1.2 Lpg 1998>0, Clio li 1.2 Lpg 1999>0, Clio li 1.4 1998>0, Clio li 1.4 16V 1999>0, Clio li 1.4 16V 2000>0, Clio li 1.5 Dci 2001>0, Clio li 1.6 1998>0, Clio li 1.6 16V 1999>0, Clio li 1.6 16V 1998>0, Clio li 1.6 Authentique Hi-Flex 2004>0, Clio li 1.6 Flex 2000>0, Clio li 1.6 Hi-Flex 2005>0, Clio li 1.9 D 1998>0, Clio li 1.9 D 2000>0, Clio li 1.9 Dti 1999>0, Clio li 2.0 16V Sport 2000>0, Clio li 3.0 V6 Sport 2000>0, Clio li 3.0 V6 Sport 2002>0, Clio li Box 1.2 1999>0, Clio li Box 1.2 1998>0, Clio li Box 1.5 Dci 2001>0, Clio li Box 1.9 D 1998>0, Clio li Box 1.9 D 2000>0, Clio li Box 1.9 D 1999>0, Clio li Box 1.9 Dti 2000>0, Thalia I 1.2 16V 2002>0, Thalia I 1.4 2000>0, Thalia I 1.4 16V 2000>0, Thalia I 1.5 Dci 2001>0, Thalia I 1.6 1998>0, Thalia I 1.6 16V 1999>0, Thalia I 1.9 D 1998>0

GS2747 // NEW //

REAR WHEEL SENSOR (LEFT SIDE)

REPLACES / REEMPLAZA:
 Nissan: 479019CA5A, 47901EA005;
 Meat & Doria: 90756E
APPLICATION / APLICACIÓN:
NISSAN: Np300 Navara 2.5 Dci 2005>0, Np300 Navara 2.5 Dci 4Wd 2005>0, Np300 Navara 2.5 Dci 4Wd 2009>0, Np300 Navara 3.0 Dci 4Wd 2010>0, Np300 Navara Platform/Chassis 2.5 Dci 2005>0, Np300 Navara Platform/Chassis 2.5 Dci 4Wd 2005>0, Np300 Navara Platform/Chassis 3.0 Dci 2010>0

GS2750 // NEW //

FRONT WHEEL SENSOR (LEFT SIDE)

REPLACES / REEMPLAZA:
 Toyota: 8954333080; **A.B.S.:** 31111
APPLICATION / APLICACIÓN:
LEXUS: Es 3.5 2006>0;
TOYOTA: Aurion 3.5 2006>0, Camry Saloon 2.4 2006>0, Camry Saloon 3.5 2006>0

GS2754 // NEW //

FRONT WHEEL SENSOR (LEFT SIDE)

REPLACES / REEMPLAZA:
 Honda: 57455SX003; **A.B.S.:** 30850
APPLICATION / APLICACIÓN:
HONDA: Cr-V Iii 2.0 I-Vtec 2007>0, Cr-V Iii 2.0 I-Vtec 4Wd 2006>0, Cr-V Iii 2.2 I-Ctdi 4Wd 2007>0, Cr-V Iii 2.2 I-Dtec 4Wd 2007>0, Cr-V Iii 2.4 2006>0, Cr-V Iii 2.4 2007>0, Cr-V Iii 2.4 4Wd 2006>0, Cr-V Iii 2.4 I-Vtec 4Wd 2007>0, Cr-V Iii 2.4 I-Vtec 4Wd 2006>0, Cr-V Iii 2.4 I-Vtec 4Wd 2009>0, Cr-V Iv 2.0 2012>0

GS2755 // NEW //

REAR WHEEL SENSOR (LEFT SIDE)

REPLACES / REEMPLAZA:
 Honda: 57475SX003, 57475SX013; **A.B.S.:** 31291
APPLICATION / APLICACIÓN:
HONDA: Cr-V Iii 2.0 I-Vtec 2007>0, Cr-V Iii 2.0 I-Vtec 4Wd 2006>0, Cr-V Iii 2.2 I-Ctdi 4Wd 2007>0, Cr-V Iii 2.2 I-Dtec 4Wd 2007>0, Cr-V Iii 2.4 2006>0, Cr-V Iii 2.4 2007>0, Cr-V Iii 2.4 4Wd 2006>0, Cr-V Iii 2.4 I-Vtec 4Wd 2007>0, Cr-V Iii 2.4 I-Vtec 4Wd 2006>0, Cr-V Iii 2.4 I-Vtec 4Wd 2009>0, Cr-V Iv 2.0 2012>0

GS2756 // NEW //

FRONT WHEEL SENSOR (RIGHT SIDE)

REPLACES / REEMPLAZA:
 Hyundai: 598302H300, 598302L300; **A.B.S.:** 30871;
 Meat & Doria: 90477
APPLICATION / APLICACIÓN:
HYUNDAI: I30 1.4 2007>0, I30 1.6 2007>0, I30 1.6 Crdi 2007>0, I30 2.0 2007>0, I30 2.0 Crdi 2007>0, I30 Estate 1.4 2007>0, I30 Estate 1.6 2007>0, I30 Estate 1.6 Crdi 2007>0, I30 Estate 2.0 2007>0, I30 Estate 2.0 Crdi 2007>0



GS2757 // NEW //
REAR WHEEL SENSOR (RIGHT SIDE)
REPLACES / REEMPLAZA:
Hyundai: 599302H300; **A.B.S.:** 31505;

Meat & Doria: 90479

APPLICATION / APLICACIÓN:
HYUNDAI: I30 1.4 2007>0, I30 1.6 2007>0, I30 1.6 Crdi 2007>0, I30 2.0 2007>0, I30 2.0 Crdi 2007>0, I30 Estate 1.4 2007>0, I30 Estate 1.6 2007>0, I30 Estate 1.6 Crdi 2007>0, I30 Estate 2.0 2007>0, I30 Estate 2.0 Crdi 2007>0

GS2762 // NEW //
REAR WHEEL SENSOR (BOTH SIDES)
REPLACES / REEMPLAZA:
Nissan: 4790W0600

APPLICATION / APLICACIÓN:
NISSAN Pathfinder 2000>2004

GS2764 // NEW //
REAR WHEEL SENSOR (RIGHT SIDE)
REPLACES / REEMPLAZA:
Mitsubishi: 4670A580, MN116244;

Meat & Doria: 90908E

APPLICATION / APLICACIÓN:
MITSUBISHI: Asx 1.6 Mivec 2010>0, Asx 1.8 2008>0, Asx 1.8 Di-D 2010>0, Asx 1.8 Di-D 4Wd 2010>0, Asx 2.0 Mivec 2010>0, Asx 2.0 Mivec 4Wd 2010>0, Lancer Viii 1.5 2008>0, Lancer Viii 1.5 Bifuel 2010>0, Lancer Viii 1.6 Mivec 2010>0, Lancer Viii 1.8 2008>0, Lancer Viii 1.8 Bifuel 2010>0, Lancer Viii 1.8 Di-D 2010>0, Lancer Viii 1.8 Flexfuel 2009>0, Lancer Viii 1.8 Flexfuel 2010>0, Lancer Viii 1.8 Mivec 2009>0, Lancer Viii 2.0 2006>0, Lancer Viii 2.0 2013>0, Lancer Viii 2.0 Di-D 2008>0, Lancer Viii Sportback 1.5 2008>0, Lancer Viii Sportback 1.5 Bifuel 2010>0, Lancer Viii Sportback 1.6 Mivec 2010>0, Lancer Viii Sportback 1.8 2008>0, Lancer Viii Sportback 1.8 Bifuel 2010>0, Lancer Viii Sportback 1.8 Di-D 2010>0, Lancer Viii Sportback 1.8 Flex 2009>0, Lancer Viii Sportback 1.8 Mivec 2009>0, Lancer Viii Sportback 2.0 Di-D 2008>0, Outlander li 2.0 2006>0, Outlander li 2.0 4Wd 2006>0, Outlander li 2.2 Di-D 2006>0, Outlander li 2.2 Di-D 4Wd 2006>0

GS2765 // NEW //
FRONT WHEEL SENSOR (RIGHT SIDE)
REPLACES / REEMPLAZA:
Kia: 598301M300; **Meat & Doria:** 90838, 90838E

APPLICATION / APLICACIÓN:
KIA: Cerato li Saloon 1.6 2010>0, Cerato li Saloon 1.6 Cvvt 2009>0, Cerato li Saloon 2.0 2009>0, Cerato Koup 1.6 Cvvt 2009>0, Cerato Koup 2.0 Cvvt 2009>0

GS2768 // NEW //
REAR WHEEL SENSOR (RIGHT SIDE)
REPLACES / REEMPLAZA:
Nissan: 47900EL00A; **A.B.S.:** 31636;

Meat & Doria: 90919E

APPLICATION / APLICACIÓN:
NISSAN: Tiida Hatchback 1.5 2004>0, Tiida Hatchback 1.5 Dci 2007>0, Tiida Hatchback 1.6 2007>0, Tiida Hatchback 1.8 2007>0, Tiida Saloon 1.5 Dci 2007>0, Tiida Saloon 1.6 2007>0, Tiida Saloon 1.8 2007>0

GS2774 // NEW //
FRONT WHEEL SENSOR (RIGHT SIDE)
REPLACES / REEMPLAZA:
Honda: 57450SNA003, 57450SNA013; **A.B.S.:** 30840;

Delphi: SS20584; **Meat & Doria:** 90558;

Mobiletron: AB-JP003

APPLICATION / APLICACIÓN:
HONDA: Civic Coupe 1.8 2005>0, Civic Viii Hatchback 1.6 2005>0, Civic Viii Hatchback 1.8 2005>0, Civic Viii Saloon 1.3 Hybrid 2005>0, Civic Viii Saloon 1.3 Hybrid 2006>0, Civic Viii Saloon 1.6 2005>0, Civic Viii Saloon 1.8 2005>0, Civic Viii Saloon 1.8 Cng 2005>0, Civic Viii Saloon 1.8 Exs Flex 2006>0

GS2775 // NEW //
REAR WHEEL SENSOR (RIGHT SIDE)
REPLACES / REEMPLAZA:
Honda: 57470SNA003, 57470SNA013; **A.B.S.:** 30842;

Meat & Doria: 90560; **Mobiletron:** B-JP011

APPLICATION / APLICACIÓN:
HONDA: Civic Viii Saloon 1.3 Hybrid 2006>0, Civic Viii Saloon 1.3 Hybrid 2010>0, Civic Viii Saloon 1.6 2005>0, Civic Viii Saloon 1.8 2005>0, Civic Viii Saloon 1.8 Exs Flex 2006>0

GS2780 // NEW //
FRONT WHEEL SENSOR (BOTH SIDES)
REPLACES / REEMPLAZA:
Land Rover: SSB500132, SSB500133, 0265007924,

0265007778; Bosch: 0 265 007 778; **A.B.S.:** 30585;

Delphi: SS20375; **Meat & Doria:** 90240

APPLICATION / APLICACIÓN:
LAND ROVER: Range Rover Sport 2.7 D 4X4 2005>2013, Range Rover Sport 3.0 D 4X4 2009>2013, Range Rover Sport 3.6 D 4X4 2006>2013, Range Rover Sport 4.2 4X4 2005>2013, Range Rover Sport 4.4 4X4 2005>2013, Range Rover Sport 5.0 4X4 2009>2013

GS2781 // NEW //
FRONT WHEEL SENSOR (LEFT SIDE)
REPLACES / REEMPLAZA:
Honda: 57455T5R003; **A.B.S.:** 31773

APPLICATION / APLICACIÓN:
HONDA: Jazz Iv 1.3 2015>0, Jazz Iv 1.5 2015>0

GS2793
REPLACES / REEMPLAZA:
Bosch: 0 265 006 793

Peugeot: 96480873, 4545 A8

Citroën: 96480873, 4545 A8

APPLICATION / APLICACIÓN:
Citroën: Berlingo MultiSpace/Van

Peugeot: Partner Mk1 Mpv/Van



GS2801
FRONT WHEEL SENSOR

REPLACES / REEMPLAZA:

Renault: 8200274801, 8200037443

APPLICATION / APLICACIÓN:

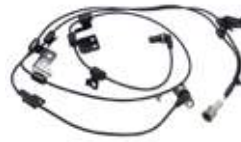
Renault: Master Mk2 Minibus/Van/Flatbed, Master II Van/ Furgão

GS2825 // NEW //
REAR WHEEL SENSOR (RIGHT SIDE)

REPLACES / REEMPLAZA:

Nissan: 479007Z710, 479007Z700

APPLICATION / APLICACIÓN:

NISSAN Frontier 1999>2006, Xterra 2001>2005

GS2857 // NEW //
REAR WHEEL SENSOR (LEFT SIDE)

REPLACES / REEMPLAZA:

Toyota: 8954642040; **A.B.S.:** 31136;

Meat & Doria: 90578

APPLICATION / APLICACIÓN:

TOYOTA: Rav 4 Iii 2.0 2008>0, Rav 4 Iii 2.0 4Wd 2006>0, Rav 4 Iii 2.0 4Wd 2008>0, Rav 4 Iii 2.2 D 2008>0, Rav 4 Iii 2.2 D 4Wd 2006>0

GS2860 // NEW //
FRONT WHEEL SENSOR (RIGHT SIDE)

REPLACES / REEMPLAZA:

VW/ Audi/ Seat/ Skoda: WHT003860, 6Q0927804A,

 6Q0927804B; **Bosch:** 0 986 594 501; **Bremi:** 50324;

Cargo: 181859; **Era:** 560094;

Meat & Doria: 90048; **Mobiletron:** AB-EU038

APPLICATION / APLICACIÓN:

AUDI: A1 1.0 TFSI 2015>2018, A1 Sportback 1.0 TFSI 2015>2018, A2 hatch 1.4 2000>2005, A2 hatch 1.6 FSI 2002>2005, A3 1.0 TFSI 2016>, A3 Sportback 1.0 TFSI 2016>, Q2 1.0 TFSI 2016>, TT Roadster 1.8 TFSI 2015>

SEAT: Arona 1.0/1.5 TSI 2017>, Ateca 1.0 TSI 2016>, Cordoba Mk2 saloon 1.2 2002>2006, Ibiza Mk4 hatch 1.2 2007>2008, Leon 1.0 TSI 2015>, Mii 1.0 2011>

SKODA: Citigo 1.0 2011>, Fabia Mk1 hatch 1.0 1999>2002, Karoq 1.0 TSI 2017>, Kodiaq 1.4 TSI 2016>, Octavia III 1.0 TSI 2016>, Roomster MPV 1.2 2006>2007, Praktik Van 1.2 2007>2015

VOLKSWAGEN: Arteon 1.5 TSI 2017>, Arteon 2.0 2017>, Fox hatch 1.2 2005>, Golf SportsVan 1.0 TSI 2015>, Passat Variant 1.4 TSI 2014>, Polo 1.0 2017>, Tiguan 1.4 TSI 2016>, Touran 1.2/1.4/1.8 TSI 2015>, T-Roc 1.0 TSI 2017>, Up 1.0 2011>, Up 1.0 TSI 2016>

Ps: Set of GS2861/ GS2862/ GS2863

GS2861 // NEW //
FRONT WHEEL SENSOR (LEFT SIDE)

REPLACES / REEMPLAZA:

VW/ Audi/ Seat/ Skoda: WHT003861, 6Q0927803A,

 6Q0927803B; **Bosch:** 0 986 594 500; **Bremi:** 50303;

Cargo: 181858; **Era:** 560093;

Meat & Doria: 90056; **Mobiletron:** AB-EU039

APPLICATION / APLICACIÓN:

AUDI: A1 1.0 TFSI 2015>2018, A1 Sportback 1.0 TFSI 2015>2018, A2 hatch 1.4 2000>2005, A2 hatch 1.6 FSI 2002>2005, A3 1.0 TFSI 2016>, A3 Sportback 1.0 TFSI 2016>, Q2 1.0 TFSI 2016>, TT Roadster 1.8 TFSI 2015>

SEAT: Arona 1.0/1.5 TSI 2017>, Ateca 1.0 TSI 2016>, Cordoba Mk2 saloon 1.2 2002>2006, Ibiza Mk4 hatch 1.2 2007>2008, Leon 1.0 TSI 2015>, Mii 1.0 2011>

SKODA: Citigo 1.0 2011>, Fabia Mk1 hatch 1.0 1999>2002, Karoq 1.0 TSI 2017>, Kodiaq 1.4 TSI 2016>, Octavia III 1.0 TSI 2016>, Roomster MPV 1.2 2006>2007, Praktik Van 1.2 2007>2015

VOLKSWAGEN: Arteon 1.5 TSI 2017>, Arteon 2.0 2017>, Fox hatch 1.2 2005>, Golf SportsVan 1.0 TSI 2015>, Passat Variant 1.4 TSI 2014>, Polo 1.0 2017>, Tiguan 1.4 TSI 2016>, Touran 1.2/1.4/1.8 TSI 2015>, T-Roc 1.0 TSI 2017>, Up 1.0 2011>, Up 1.0 TSI 2016>

PS: Set of GS2860/ GS2862/ GS2863

GS2862 // NEW //
REAR WHEEL SENSOR (RIGHT SIDE)

REPLACES / REEMPLAZA:

VW/ Audi/ Seat/ Skoda: WHT003862, 6Q0927808A,

 6Q0927808B; **Bosch:** 0 986 594 503; **Bremi:** 50306;

Cargo: 182286; **Era:** 560294;

Meat & Doria: 90059; **Mobiletron:** AB-EU104

APPLICATION / APLICACIÓN:

AUDI: A1 1.0 TFSI 2015>2018, A1 Sportback 1.0 TFSI 2015>2018, A2 hatch 1.4 2000>2005, A2 hatch 1.6 FSI 2002>2005, A3 1.0 TFSI 2016>, A3 Sportback 1.0 TFSI 2016>, Q2 1.0 TFSI 2016>, TT Roadster 1.8 TFSI 2015>

SEAT: Arona 1.0/1.5 TSI 2017>, Ateca 1.0 TSI 2016>, Cordoba Mk2 saloon 1.2 2002>2006, Ibiza Mk4 hatch 1.2 2007>2008, Leon 1.0 TSI 2015>, Mii 1.0 2011>

SKODA: Citigo 1.0 2011>, Fabia Mk1 hatch 1.0 1999>2002, Karoq 1.0 TSI 2017>, Kodiaq 1.4 TSI 2016>, Octavia III 1.0 TSI 2016>, Roomster MPV 1.2 2006>2007, Praktik Van 1.2 2007>2015

VOLKSWAGEN: Arteon 1.5 TSI 2017>, Arteon 2.0 2017>, Fox hatch 1.2 2005>, Golf SportsVan 1.0 TSI 2015>, Passat Variant 1.4 TSI 2014>, Polo 1.0 2017>, Tiguan 1.4 TSI 2016>, Touran 1.2/1.4/1.8 TSI 2015>, T-Roc 1.0 TSI 2017>, Up 1.0 2011>, Up 1.0 TSI 2016>

PS: set of GS2860/ GS2861/ GS2863



GS2863 // NEW //

REAR WHEEL SENSOR (LEFT SIDE)

REPLACES / REEMPLAZA:

VW/ Audi/ Seat/ Skoda: WHT003863, 6Q0927807A,

6Q0927807B; Bosch: 0 986 594 502; Bremi: 50308;

Cargo: 182285; Era: 560225;

Meat & Doria: 90058; Mobiletron: AB-EU097

APPLICATION / APLICACIÓN:

AUDI: A1 1.0 TFSI 2015>2018, A1 Sportback 1.0 TFSI 2015>2018, A2 hatch 1.4 2000>2005, A2 hatch 1.6 FSI 2002>2005, A3 1.0 TFSI 2016>, A3 Sportback 1.0 TFSI 2016>, Q2 1.0 TFSI 2016>, TT Roadster 1.8 TFSI 2015>

SEAT: Arona 1.0/1.5 TSI 2017>, Ateca 1.0 TSI 2016>, Cordoba Mk2 saloon 1.2 2002>2006, Ibiza Mk4 hatch 1.2 2007>2008, Leon 1.0 TSI 2015>, Mii 1.0 2011>

SKODA: Citigo 1.0 2011>, Fabia Mk1 hatch 1.0 1999>2002, Karoq 1.0 TSI 2017>, Kodiaq 1.4 TSI 2016>, Octavia III 1.0 TSI 2016>, Roomster MPV 1.2 2006>2007, Praktik Van 1.2 2007>2015

VOLKSWAGEN: Arteon 1.5 TSI 2017>, Arteon 2.0 2017>, Fox hatch 1.2 2005>, Golf SportsVan 1.0 TSI 2015>, Passat Variant 1.4 TSI 2014>, Polo 1.0 2017>, Tiguan 1.4 TSI 2016>, Touran 1.2/1.4/1.8 TSI 2015>, T-Roc 1.0 TSI 2017>, Up 1.0 2011>, Up 1.0 TSI 2016>

PS: set of GS2860/ GS2861/ GS2862



GS2867

FRONT WHEEL SENSOR (LEFT SIDE)

REPLACES / REEMPLAZA:

Chevrolet: 15725355

GMC: 15725355

APPLICATION / APLICACIÓN:

Chevrolet: Blazer, S10

GMC: Jimmy, Sonoma

PS: set of GS2868



GS2868

FRONT WHEEL SENSOR (RIGHT SIDE)

REPLACES / REEMPLAZA:

Chevrolet: 15725356

GMC: 15725356

APPLICATION / APLICACIÓN:

Chevrolet: Blazer, S10

GMC: Jimmy, Sonoma

PS: set of GS2867



GS2873

REAR WHEEL SENSOR (RIGHT SIDE)

REPLACES / REEMPLAZA:

Bosch: 0 265 008 936

Renault: 479505873R

APPLICATION / APLICACIÓN:

Renault: Duster 1.6/2.0

PS: set of GS2973



GS2884

FRONT WHEEL SENSOR (LEFT SIDE)

REPLACES / REEMPLAZA:

Ford: F87Z2C204HA, F87Z2C204JA, 3L5Z2C204BA,

6L5Z2C204BA

Mazda: Z2P043801, 1F6043801, 1F6043801A

APPLICATION / APLICACIÓN:

Ford: Explorer

Mazda: B2300, B2500, B3000, B4000



GS2887 // NEW //

FRONT WHEEL SENSOR (RIGHT SIDE)

REPLACES / REEMPLAZA:

VOLVO: 30773740/ 307737400/ 9467580/ 94675800 A.B.S.:

30232 DELPHI: SS20116 MEAT & DORIA: 90385

APPLICATION / APLICACIÓN:

VOLVO: S60 I 2.0 T 1998>0, S60 I 2.3 T5 1999>0, S60 I 2.4 1999>0, S60 I 2.4 Bifuel 2001>0, S60 I 2.4 Cdi 2003>0, S60 I 2.4 D 2001>0, S60 I 2.4 D5 2001>0, S60 I 2.4 T 1999>0, S60 I 2.4 T Awd 2001>0, S60 I 2.4 T5 2004>0, S60 I 2.5 T 2001>0, S60 I 2.5 T Awd 2002>0, S60 I R 2.5 T Awd 2003>0, S60 I T5 2000>0, S80 I 2.0 1998>0, S80 I 2.0 T 1998>0, S80 I 2.3 R 2000>0, S80 I 2.4 1999>0, S80 I 2.4 Bifuel 2001>0, S80 I 2.4 D 2001>0, S80 I 2.4 D5 2001>0, S80 I 2.4 Ltp 2004>0, S80 I 2.4 T 1999>0, S80 I 2.4 T5 Awd 2000>0, S80 I 2.5 T 2001>0, S80 I 2.5 T Awd 2002>0, S80 I 2.5 Tdi 1999>0, S80 I 2.8 T6 1998>0, S80 I 2.9 1998>0, S80 I 3.0 2001>0, S80 I 3.0 T6 2001>0, V70 li 2.0 T 1998>0, V70 li 2.3 2000>0, V70 li 2.3 Awd 2000>0, V70 li 2.3 T5 1999>0, V70 li 2.4 1999>0, V70 li 2.4 Awd 2000>0, V70 li 2.4 Bifuel 2001>0, V70 li 2.4 Cdi 2003>0, V70 li 2.4 D 2001>0, V70 li 2.4 D5 2001>0, V70 li 2.4 D5 Awd 2002>0, V70 li 2.4 T 1999>0, V70 li 2.4 T Awd 2001>0, V70 li 2.4 T5 2004>0, V70 li 2.5 T 2001>0, V70 li 2.5 T Awd 2002>0, V70 li 2.5 Tdi 1999>0, V70 li R 2.5 T Awd 2003>0, Xc70 Cross Country 2.4 D5 Awd 2002>0, Xc70 Cross Country 2.4 D5 Xc Awd 2002>0, Xc70 Cross Country 2.4 T Xc Awd 1997>0, Xc70 Cross Country 2.5 T Xc Awd 2002>0



GS2891 // NEW //

REAR WHEEL SENSOR (RIGHT SIDE)

REPLACES / REEMPLAZA:

Suzuki: 5631079J00, 5631079J01A; A.B.S.: 31016;

Meat & Doria: 90716

APPLICATION / APLICACIÓN:

FIAT: Sedici 1.6 16V 2006>0, Sedici 1.9 D Multijet 2006>0, Sedici 2.0 D Multijet 2006>0 SUZUKI: Sx4 1.5 2006>0, Sx4 1.5 Vvt 2010>0, Sx4 1.5 Vvti 2007>0, Sx4 1.6 Ddis 2007>0, Sx4 1.6 Vvt 2006>0, Sx4 1.9 Ddis 2006>0, Sx4 2.0 Ddis 2009>0, Sx4 Saloon 1.6 2007>0



GS2892 // NEW //

FRONT WHEEL SENSOR (RIGHT SIDE)

REPLACES / REEMPLAZA:

Suzuki: 5621079J00, 5621079J10; A.B.S.: 31013;

Meat & Doria: 90714

APPLICATION / APLICACIÓN:

FIAT: Sedici 1.6 16V 2006>0, Sedici 1.6 16V 4X4 2006>0, Sedici 1.9 D Multijet 2006>0, Sedici 1.9 D Multijet 4X4 2006>0, Sedici 2.0 D Multijet 2006>0, Sedici 2.0 D Multijet 4X4 2006>0 SUZUKI: Sx4 1.5 2006>0, Sx4 1.5 Vvt 2010>0, Sx4 1.5 Vvt 4X4 2010>0, Sx4 1.6 Ddis 2007>0, Sx4 1.6 Vvt 2006>0, Sx4 1.6 Vvt 4X4 2006>0, Sx4 1.9 Ddis 2006>0, Sx4 1.9 Ddis 4X4 2006>0, Sx4 2.0 Ddis 2009>0, Sx4 2.0 Ddis 4X4 2009>0, Sx4 Saloon 1.6 2007>0, Sx4 Saloon 1.6 Awd 2007>0

GS2902 // NEW //
FRONT WHEEL SENSOR (LEFT SIDE)

REPLACES / REEMPLAZA:

Ford: F6DZ2C204B, F6DZ2C204BA, F8DZ2C204BA, XF1Z2C204BA, XF1Z2C204BB

APPLICATION / APLICACIÓN:

FORD: Taurus 1999>2000

GS2908 // NEW //
REAR WHEEL SENSOR (BOTH SIDES)

REPLACES / REEMPLAZA:

Ford: 2L2Z2C190AA, 2L2Z2C190AB, 2L2Z2C190AC;

Mobiletron: AB-US015

APPLICATION / APLICACIÓN:

FORD USA: Explorer 4.0 2001>0, Explorer 4.0 4Wd 2001>0, Explorer 4.0 Flex-Fuel 4Wd 2002>0, Explorer 4.6 2001>0, Explorer 4.6 4Wd 2001>0

GS2909 // NEW //
FRONT WHEEL SENSOR (RIGHT SIDE)

REPLACES / REEMPLAZA:

Honda: 57450S3VA01, 57450S3VA02

APPLICATION / APLICACIÓN:

HONDA: Pilot 2003>2008

GS2910 // NEW //
FRONT WHEEL SENSOR (RIGHT SIDE)

REPLACES / REEMPLAZA:

Honda: 57450STXA01

APPLICATION / APLICACIÓN:

HONDA: Pilot 2009>2015

GS2913 // NEW //
FRONT WHEEL SENSOR (BOTH SIDES)

REPLACES / REEMPLAZA:

Hyundai: 9567122000; A.B.S.: 31085;

Mobiletron: AB-KR006

APPLICATION / APLICACIÓN:

HYUNDAI: Accent I 1.3 1994>0, Accent I 1.3 I 12V 1994>0, Accent I 1.5 1994>0, Accent I 1.5 I 12V 1994>0, Accent I 1.5 I 16V 1995>0, Accent Saloon 1.3 1994>0, Accent Saloon 1.3 I 12V 1994>0, Accent Saloon 1.5 1994>0, Accent Saloon 1.5 I 12V 1994>0, Accent Saloon 1.5 I 16V 1995>0

GS2915 // NEW //
FRONT WHEEL SENSOR (RIGHT SIDE)

REPLACES / REEMPLAZA:

Hyundai: 9567529000, 9567529002, 9567529500;

A.B.S.: 30861;

Delphi: SS20274;

Mobiletron: AB-KR051

APPLICATION / APLICACIÓN:

HYUNDAI: Coupe 1.6 16V 1995>0, Coupe 1.6 1997>0, Coupe 1.6 I 16V 1996>0, Coupe 2.0 16V 1995>0, Coupe F2 Evolution 1999>0, Lantra Ii 1.5 12V 1996>0, Lantra Ii 1.6 16V 1995>0, Lantra Ii 1.6 I 1995>0, Lantra Ii 1.8 16V 1995>0, Lantra Ii 1.9 D 1998>0, Lantra Ii 2.0 1997>0, Lantra Ii 2.0 16V 1995>0, Lantra Ii Estate 1.5 12V 1996>0, Lantra Ii Estate 1.6 16V 1995>0, Lantra Ii Estate 1.6 I 1995>0, Lantra Ii Estate 1.8 16V 1995>0, Lantra Ii Estate 1.9 D 1998>0, Lantra Ii Estate 2.0 1997>0, Lantra Ii Estate 2.0 16V 1995>0

GS2917 // NEW //
FRONT WHEEL SENSOR (BOTH SIDES)

REPLACES / REEMPLAZA:

Kia: 0K20543701

APPLICATION / APLICACIÓN:

KIA Sephia 1995>1998

GS2922
FRONT WHEEL SENSOR

REPLACES / REEMPLAZA:

Renault: 479101292R, 8200419177, 479101292R

Dacia: 479101292R, 8200419177, 479101292R

APPLICATION / APLICACIÓN:

Renault: Clio, Logan, Sandero

Dacia: Logan Saloon, Sandero Hatch

GS2924 // NEW //
REAR WHEEL SENSOR (BOTH SIDES)

REPLACES / REEMPLAZA:

Nissan: 479001AD0A, 479001AD0B

APPLICATION / APLICACIÓN:

NISSAN: Murano Ii 3.5 2007>0, Murano Ii 3.5 4X4 2008>0

GS2926 // NEW //
REAR WHEEL SENSOR (RIGHT SIDE)

REPLACES / REEMPLAZA:

Nissan: 479001AA0A, 479001AA0B; A.B.S.: 31782

APPLICATION / APLICACIÓN:

NISSAN: Murano Ii 2.5 Dci 4X4 2010>0, Murano Ii 3.5 2007>0, Murano Ii 3.5 4X4 2007>0

GS2930 // NEW //
REAR WHEEL SENSOR (BOTH SIDES)

REPLACES / REEMPLAZA:

Nissan: 47900CG000, 47900CG00A; A.B.S.: 31367

APPLICATION / APLICACIÓN:

INFINITI: Fx 35 2003>0, Fx 35 All-Wheel Drive 2003>0, Fx 45 2003>0, Fx 45 All-Wheel Drive 2003>0, Fx 45 Awd 2008>0

GS2936
FRONT WHEEL SENSOR

REPLACES / REEMPLAZA:

Renault: 8200441401, 479109860R

APPLICATION / APLICACIÓN:

Renault: Kangoo 1.6

GS2937

REAR WHEEL SENSOR (LEFT SIDE)

REPLACES / REEMPLAZA:
Bosch: 0 265 008 937
Renault: 479007637R
 APPLICATION / APLICACIÓN:
Renault: Duster 1.6/2.0

GS2942

REAR WHEEL SENSOR

REPLACES / REEMPLAZA:
Bosch: 0 265 008 942
Renault: 4795011 02R
 APPLICATION / APLICACIÓN:
Renault: Duster 2.0 Flex, Duster Box 1.5/1.6

GS2945 // NEW //

FRONT WHEEL SENSOR (LEFT SIDE)

REPLACES / REEMPLAZA:
Mitsubishi: MN102245; **A.B.S.:** 31727
 APPLICATION / APLICACIÓN:
MITSUBISHI: Grandis 2.0 Di-D 2005>0, Grandis 2.4 Mivec 2004>0

GS2946

REAR WHEEL SENSOR (LEFT SIDE)

REPLACES / REEMPLAZA:
Bosch: 0 265 008 946
Renault: 479000527R
 APPLICATION / APLICACIÓN:
Renault: Sandero Stepway 1.0/1.6
Dacia: Logan saloon/estate, Sandero hatch
PS: set of GS2947

GS2947

REAR WHEEL SENSOR (RIGHT SIDE)

REPLACES / REEMPLAZA:
Bosch: 0 265 008 947
Renault: 479007380R
 APPLICATION / APLICACIÓN:
Renault: Sandero Stepway 1.4/1.6
Dacia: Logan saloon/estate, Sandero hatch
PS: set of GS2946

GS2958 // NEW //

REAR WHEEL SENSOR (RIGHT SIDE)

REPLACES / REEMPLAZA:
Renault: 479007700R; **A.B.S.:** 31527;
Bosch: 0 986 594 652
 APPLICATION / APLICACIÓN:
DACIA: Logan li 1.0 Sce 75 2016>0, Logan li 1.2 2012>0, Logan li 1.2 Lpg 2012>0, Logan li 1.5 Blue Dci 95 2018>0, Logan li 1.5 Dci 2009>0, Logan li 1.5 Dci / Blue Dci 75 2012>0, Logan li 1.6 2012>0, Logan li Tce 90 2012>0, Logan li Tce 90 Lpg 2015>0, Logan Mcv li 1.0 Sce 75 2016>0, Logan Mcv li 1.2 2012>0, Logan Mcv li 1.2 Lpg 2012>0, Logan Mcv li 1.5 Blue Dci 95 2018>0, Logan Mcv li 1.5 Dci 2009>0, Logan Mcv li 1.6 2012>0, Logan Mcv li Tce 90 2012>0, Logan Mcv li Tce 90 Lpg 2015>0, Sandero li 1.0 Sce 75 2016>0, Sandero li 1.2 2012>0, Sandero li 1.2 Lpg 2012>0, Sandero li 1.5 Blue Dci 95 2018>0, Sandero li 1.5 Dci 2009>0, Sandero li 1.5 Dci 75 / Blue Dci 75 2012>0, Sandero li 1.6 2012>0, Sandero li Tce 90 2012>0, Sandero li Tce 90 Lpg 2015>0 RENAULT: Logan li Estate 1.2 16V 2013>0, Logan li Estate 1.2 16V Lpg 2013>0, Logan li Estate 1.5 Dci 2009>0, Logan li Estate 1.6 2012>0, Logan/Stepway li 1.0 Hi-Flex 2013>0, Logan/Stepway li 1.2 2012>0, Logan/Stepway li 1.5 Dci 2009>0, Logan/Stepway li 1.6 2012>0, Logan/Stepway li 1.6 Flex 2012>0, Sandero/Stepway I 1.0 Authentique Hi-Flex 2014>0, Sandero/Stepway I 1.6 Flex 2014>0, Sandero/Stepway li 1.6 2012>0, Sandero/Stepway li 1.6 16V 2014>0, Sandero/Stepway li 1.6 Hi-Flex 2017>0, Thalia li 0.9 Tce 2012>0, Thalia li 1.5 Dci 2009>0, Thalia li 1.2 16V 2013>0, Thalia li 1.5 Dci 2009>0

GS2959

REAR WHEEL SENSOR

REPLACES / REEMPLAZA:
Bosch: 0 265 008 959
Fiat: 51918677
 APPLICATION / APLICACIÓN:
Fiat: Uno, Grand Siena
PS: set of GS2963

GS2961

REPLACES / REEMPLAZA:
Ford: F57Z2C204GD, F57Z2C204GC
 APPLICATION / APLICACIÓN:
Ford: Ranger 1995>1997

GS2962 // NEW //

REAR WHEEL SENSOR (BOTH SIDES)

REPLACES / REEMPLAZA:
Land Rover: SSF500021; **Delphi:** SS20475;
A.B.S.: 31227
 APPLICATION / APLICACIÓN:
LAND ROVER: Range Rover li 3.0 D 4X4 2002>0, Range Rover li 3.6 D 4X4 2006>0, Range Rover li 4.2 4X4 2005>0, Range Rover li 4.2 Supercharged 4X4 2005>0, Range Rover li 4.4 4X4 2002>0, Range Rover li 4.4 D 4X4 2010>0, Range Rover li 5.0 4X4 2009>0

GS2963

FRONT WHEEL SENSOR

REPLACES / REEMPLAZA:
Bosch: 0 265 008 963
Fiat: 51918676
 APPLICATION / APLICACIÓN:
Fiat: Uno, Grand Siena
PS: set of GS2959



GS2964

REAR WHEEL SENSOR (LEFT SIDE)

REPLACES / REEMPLAZA:
Bosch: 0 265 008 964
Fiat: 51918276
APPLICATION / APLICACIÓN:
Fiat: Idea 1.4/1.6/1.8
PS: set of GS2965

GS2965

REAR WHEEL SENSOR (RIGHT SIDE)

REPLACES / REEMPLAZA:
Bosch: 0 265 008 965
Fiat: 51918277
APPLICATION / APLICACIÓN:
Fiat: Idea 1.4/1.6/1.8

GS2966

FRONT WHEEL SENSOR

REPLACES / REEMPLAZA:
Bosch: 0 265 008 966
Fiat: 51918224
APPLICATION / APLICACIÓN:
Fiat: Idea 1.8, Palio 1.8, Strada 1.6/1.8

GS2967

REAR WHEEL SENSOR (RIGHT SIDE)

REPLACES / REEMPLAZA:
Bosch: 0 265 008 967
Fiat: 51918271
APPLICATION / APLICACIÓN:
Fiat: Strada 1.4 CD

GS2968

REPLACES / REEMPLAZA:
Chevrolet: 94543968, 95937220, 95976062
APPLICATION / APLICACIÓN:
Chevrolet: Spark 1.0/1.2 2010+

GS2969

REPLACES / REEMPLAZA:
Chevrolet: 94543969, 95937222, 95976063
APPLICATION / APLICACIÓN:
Chevrolet: Spark 1.0/1.2 2010+

GS2970

REAR WHEEL SENSOR (LEFT SIDE)

REPLACES / REEMPLAZA:
Bosch: 0 265 008 970
Fiat: 51918287
APPLICATION / APLICACIÓN:
Fiat: Fiorino 1.4, Strada 1.6/1.8

GS2971

REAR WHEEL SENSOR (LEFT SIDE)

REPLACES / REEMPLAZA:
Bosch: 0 265 008 971
Fiat: 51918272
APPLICATION / APLICACIÓN:
Fiat: Palio Weekend 1.4/1.6
PS: set of GS2972

GS2972

REAR WHEEL SENSOR (RIGHT SIDE)

REPLACES / REEMPLAZA:
Bosch: 0 265 008 972
Fiat: 51918273
APPLICATION / APLICACIÓN:
Fiat: Palio Weekend 1.4/1.6
PS: set of GS2971

GS2973

REAR WHEEL SENSOR (RIGHT SIDE)

REPLACES / REEMPLAZA:
Bosch: 0 265 008 973
Fiat: 51918274
APPLICATION / APLICACIÓN:
Fiat: Palio Weekend 1.8
PS: set of GS2873/ GS2974

GS2974

REAR WHEEL SENSOR (LEFT SIDE)

REPLACES / REEMPLAZA:
Bosch: 0 265 008 974
Fiat: 51918275
APPLICATION / APLICACIÓN:
Fiat: Palio Weekend 1.4/1.8
PS: set of GS2973

GS2975

REAR WHEEL SENSOR

REPLACES / REEMPLAZA:
Bosch: 0 265 008 975
Fiat: 51918270
APPLICATION / APLICACIÓN:
Fiat: Palio 1.0/1.4, Siena 1.0/1.4, Grand Siena 1.4

GS2976

FRONT WHEEL SENSOR (RIGHT SIDE)

REPLACES / REEMPLAZA:
Bosch: 0 265 008 976
Fiat: 51918222
APPLICATION / APLICACIÓN:
Fiat: Palio 1.0/1.4, Palio Weekend 1.4/1.6, Siena 1.0/1.4, Grand Siena 1.4, Strada 1.4
PS: set of GS2977

GS2977

FRONT WHEEL SENSOR (LEFT SIDE)

REPLACES / REEMPLAZA:
Bosch: 0 265 008 977
Fiat: 51918223
APPLICATION / APLICACIÓN:
Fiat: Palio 1.0/1.4, Palio Weekend 1.4, Siena 1.0/1.4, Grand Siena 1.4, Strada 1.4
PS: set of GS2976



GS2978

FRONT WHEEL SENSOR (LEFT SIDE)

REPLACES / REEMPLAZA:

Bosch: 0 265 008 978; **Fiat:** 51918225

APPLICATION / APLICACIÓN:

Fiat: Idea 1.4/1.6

OBS: conjunto do GS2979



GS2979

FRONT WHEEL SENSOR (RIGHT SIDE)

REPLACES / REEMPLAZA:

Bosch: 0 265 008 979; **Fiat:** 51918225

APPLICATION / APLICACIÓN:

Fiat: Idea 1.4/1.6

PS: set of GS2978



GS2990 // NEW //

FRONT WHEEL SENSOR (LEFT SIDE)

REPLACES / REEMPLAZA:

Suzuki: 5622065J00; **A.B.S.:** 31313

APPLICATION / APLICACIÓN:

SUZUKI: Grand Vitara I 2.7 4X4 2001>0, Grand Vitara li 1.6 2005>0, Grand Vitara li 1.6 All-Wheel Drive 2005>0, Grand Vitara li 1.9 Ddis 2006>0, Grand Vitara li 1.9 Ddis All-Wheel Drive 2005>0, Grand Vitara li 2.0 2005>0, Grand Vitara li 2.0 All-Wheel Drive 2005>0, Grand Vitara li 2.4 All-Wheel Drive 2009>0, Grand Vitara li 2.7 All-Wheel Drive 2005>0, Grand Vitara li 3.2 All-Wheel Drive 2008>0, Grand Vitara li 3.2 All-Wheel Drive 2009>0



GS2991 // NEW //

FRONT WHEEL SENSOR (RIGHT SIDE)

REPLACES / REEMPLAZA:

Suzuki: 5621065J00; **A.B.S.:** 31314

APPLICATION / APLICACIÓN:

SUZUKI: Grand Vitara I 2.7 4X4 2001>0, Grand Vitara li 1.6 2005>0, Grand Vitara li 1.6 All-Wheel Drive 2005>0, Grand Vitara li 1.9 Ddis 2006>0, Grand Vitara li 1.9 Ddis All-Wheel Drive 2005>0, Grand Vitara li 2.0 2005>0, Grand Vitara li 2.0 All-Wheel Drive 2005>0, Grand Vitara li 2.4 All-Wheel Drive 2009>0, Grand Vitara li 2.7 All-Wheel Drive 2005>0, Grand Vitara li 3.2 All-Wheel Drive 2008>0, Grand Vitara li 3.2 All-Wheel Drive 2009>0



GS2992 // NEW //

REAR WHEEL SENSOR (RIGHT SIDE)

REPLACES / REEMPLAZA:

Suzuki: 5631065J00, 5631065J01; **A.B.S.:** 31316

APPLICATION / APLICACIÓN:

SUZUKI: Grand Vitara I 2.7 4X4 2001>0, Grand Vitara li 1.6 2005>0, Grand Vitara li 1.6 All-Wheel Drive 2005>0, Grand Vitara li 1.9 Ddis 2006>0, Grand Vitara li 1.9 Ddis All-Wheel Drive 2005>0, Grand Vitara li 2.0 2005>0, Grand Vitara li 2.0 All-Wheel Drive 2005>0, Grand Vitara li 2.4 All-Wheel Drive 2009>0, Grand Vitara li 2.7 All-Wheel Drive 2005>0, Grand Vitara li 3.2 All-Wheel Drive 2008>0, Grand Vitara li 3.2 All-Wheel Drive 2009>0



GS2993 // NEW //

REAR WHEEL SENSOR (LEFT SIDE)

REPLACES / REEMPLAZA:

Suzuki: 5632065J00, 5632065J01; **A.B.S.:** 31315

APPLICATION / APLICACIÓN:

SUZUKI: Grand Vitara I 2.7 4X4 2001>0, Grand Vitara li 1.6 2005>0, Grand Vitara li 1.6 All-Wheel Drive 2005>0, Grand Vitara li 1.9 Ddis 2006>0, Grand Vitara li 1.9 Ddis All-Wheel Drive 2005>0, Grand Vitara li 2.0 2005>0, Grand Vitara li 2.0 All-Wheel Drive 2005>0, Grand Vitara li 2.4 All-Wheel Drive 2009>0, Grand Vitara li 2.7 All-Wheel Drive 2005>0, Grand Vitara li 3.2 All-Wheel Drive 2008>0, Grand Vitara li 3.2 All-Wheel Drive 2009>0



GS2995 // NEW //

REAR WHEEL SENSOR (LEFT SIDE)

REPLACES / REEMPLAZA:

Volvo: 9128422, 9162612, 91626120; **Bosch:** 0 280 142 341; **Mobiletron:** AB-EU176

APPLICATION / APLICACIÓN:

VOLVO: 850 2.0 1991>1996, 850 2.0 Turbo 1993>1996, 850 2.3 T5 1993>1996, 850 2.3 T5-R 1995>1996, 850 2.4 1991>1994, 850 2.4 Gle 1993>1997, 850 2.5 Tdi 1995>1996, 850 Sw 2.0 1993>1996, 850 Sw 2.0 Turbo 1993>1996, 850 Sw 2.3 T5 1993>1996, 850 Sw 2.3 T5-R 1995>1996, 850 Sw 2.4 1992>1994, 850 Sw 2.4 Awd 1996>1996, 850 Sw 2.5 Tdi 1995>1996, C70 I Conversivel 2.0 1998>2005, C70 I Conversivel 2.0 T 1998>2005, C70 I Conversivel 2.3 T5 1998>2005, C70 I Conversivel 2.4 1998>2005, C70 I Conversivel 2.4 T 1998>2005, C70 I Coupé 2.0 1997>2002, C70 I Coupé 2.0 T 1997>2002, C70 I Coupé 2.3 T-5 1997>2002, C70 I Coupé 2.4 T 1997>2002, S70 2.0 1997>2000, S70 2.0 Turbo 1997>2000, S70 2.3 T-5 1997>2000, S70 2.3 Turbo 1997>2000, S70 2.4 1997>2000, S70 2.4 Bifuel 1998>2000, S70 2.4 T5 Awd 1996>1999, S70 2.4 Turbo 1997>2000, S70 2.5 Tdi 1997>2000, V70 I 2.0 1995>2000, V70 I 2.0 Turbo 1995>2000, V70 I 2.0 Turbo Awd 1996>2000, V70 I 2.3 T Awd 1997>2000, V70 I 2.3 T-5 1996>2000, V70 I 2.3 T-5 Awd 1997>2000, V70 I 2.3 Turbo 1995>2000, V70 I 2.4 1995>1999, V70 I 2.4 Awd 1998>1999, V70 I 2.4 Bifuel 1998>1999, V70 I 2.4 Turbo 1996>2000, V70 I 2.4 Turbo Awd 1996>2000, V70 I 2.5 Tdi 1995>2000



GS2996 // NEW //

FRONT WHEEL SENSOR (BOTH SIDES)

REPLACES / REEMPLAZA:

Jeep: 5103493AA

APPLICATION / APLICACIÓN:

DODGE: Ram 1500 Crew Cab Pickup 4.7 2001>0, Ram 1500 Crew Cab Pickup 5.7 2001>0, Ram 1500 Crew Cab Pickup 5.7 4Wd 2002>0, Ram 1500 Crew Cab Pickup 8.3 Srt-10 2003>0, Ram 1500 Extended Crew Cab Pickup 5.7 2001>0, Ram 1500 Extended Crew Cab Pickup 5.7 4Wd 2002>0, Ram 1500 Pickup 3.7 2001>0, Ram 1500 Pickup 4.7 2001>0, Ram 1500 Pickup 4.7 4X4 2001>0, Ram 1500 Pickup 5.7 2001>0, Ram 1500 Pickup 5.9 4X4 2001>0, Ram 1500 Standard Cab Pickup 4.7 2001>0, Ram 1500 Standard Cab Pickup 5.7 2001>0, Ram 1500 Standard Cab Pickup 5.7 4Wd 2002>0, Ram 1500 Standard Cab Pickup 8.3 Srt-10 2003>0, Ram 2500 Cab & Chassis 5.7 2001>0, Ram 2500 Cab & Chassis 5.7 4Wd 2002>0, Ram 2500 Crew Cab Pickup 5.7 2001>0, Ram 2500 Crew Cab Pickup 5.7 4Wd 2002>0, Ram 2500 Extended Crew Cab Pickup 5.7 2001>0, Ram 2500 Extended Crew Cab Pickup 5.7 4Wd 2002>0, Ram 2500 Pickup 5.7 2001>0, Ram 2500 Pickup 5.7 4X4 2002>0, Ram 2500 Pickup 5.9 2002>0, Ram 2500 Pickup 5.9 4X4 2001>0, Ram 2500 Pickup 5.9 Di 2002>0, Ram 2500 Pickup 5.9 Di 4X4 2002>0, Ram 2500 Pickup 5.9 Td 4X4 2003>0, Ram 2500 Pickup 8.0 4X4 2002>0, Ram 2500 Standard Cab Pickup 5.7 2001>0, Ram 2500 Standard Cab Pickup 5.7 4Wd 2002>0



GS2999 // NEW //

REAR WHEEL SENSOR (BOTH SIDES)

REPLACES / REEMPLAZA:

Audi: WHT003864A, WHT003864B, WHT003864, 0986594526; **Bosch:** 0 986 594 606; **Meat & Doria:** 90571, 90571A1; **Mobiletron:** AB-EU480

APPLICATION / APLICACIÓN:

AUDI: A3 1.0 Tfsi 2016>0, A3 1.2 Tfsi 2013>0, A3 1.4 Tfsi 2012>0, A3 1.4 Tsi 2012>0, A3 1.5 Tfsi 2017>0, A3 1.6 Tdi 2010>0, A3 1.8 Tfsi 2012>0, A3 2.0 Tdi 2010>0, A3 2.0 Tfsi 2014>0, A3 Convertible 1.4 Tfsi 2012>0, A3 Convertible 1.4 Tsi 2012>0, A3 Convertible 1.6 Tdi 2010>0, A3 Convertible 1.8 Tfsi 2012>0, A3 Convertible 2.0 Tdi 2010>0, A3 Convertible 2.0 Tfsi 2014>0, A3 Convertible 40 Tfsi 2018>0, A3 Limousine 1.0 Tfsi 2016>0, A3 Limousine 1.2 Tfsi 2013>0, A3 Limousine 1.4 Tfsi 2012>0, A3 Limousine 1.4 Tsi 2012>0, A3 Limousine 1.5 Tfsi 2017>0, A3 Limousine 1.6 Tdi 2010>0, A3 Limousine 1.8 Tfsi 2012>0, A3 Limousine 2.0 Tdi 2010>0, A3 Limousine 2.0 Tfsi 2014>0, A3 Limousine 30 Tdi 2018>0, A3 Limousine 30 Tfsi 2018>0, A3 Limousine 35 Tdi 2018>0, A3 Limousine 35 Tfsi 2018>0, A3 Limousine 40 Tfsi 2018>0, A3 Sportback 1.0 Tfsi 2016>0, A3 Sportback 1.2 Tfsi 2013>0, A3 Sportback 1.4 Tfsi 2012>0, A3 Sportback 1.4 Tfsi E-Tron 2014>0, A3 Sportback 1.4 Tfsi G-Tron 2013>0, A3 Sportback 1.4 Tsi 2012>0, A3 Sportback 1.5 Tfsi 2017>0, A3 Sportback 1.6 Tdi 2010>0, A3 Sportback 1.8 Tfsi 2012>0, A3 Sportback 2.0 Tdi 2010>0, A3 Sportback 2.0 Tfsi 2014>0, A3 Sportback 30 G-Tron 2018>0, A3 Sportback 30 Tdi 2018>0, A3 Sportback 30 Tfsi 2018>0, A3 Sportback 35 Tdi 2018>0, A3 Sportback 35 Tfsi 2018>0, A3 Sportback 40 Tfsi 2018>0, Q2 1.0 Tfsi 2016>0, Q2 1.4 Tfsi 2012>0, Q2 1.6 Tdi 2010>0, Q2 2.0 Tdi 2010>0, Q3 35 Tdi 2018>0, Q3 35 Tfsi 2018>0, Tt 1.8 Tfsi 2012>0, Tt 2.0 Tdi 2010>0, Tt 2.0 Tfsi 2014>0, Tt Roadster 1.8 Tfsi 2012>0, Tt Roadster 2.0 Tdi 2010>0, Tt Roadster 2.0 Tfsi 2014>0;

SEAT: Ateca 1.0 Tsi 2015>0, Ateca 1.4 Tsi 2012>0, Ateca 1.6 Tdi 2010>0, Ateca 2.0 Tdi 2010>0, Leon 1.0 Tsi 2015>0, Leon 1.2 Tsi 2010>0, Leon 1.4 Tgi 2013>0, Leon 1.4 Tsi 2012>0, Leon 1.6 Tdi 2010>0, Leon 1.8 Tsi 2012>0, Leon 2.0 Cupra 2013>0, Leon 2.0 Tdi 2010>0, Leon Box Body / Hatchback 1.0 Tsi 2015>0, Leon Box Body / Hatchback 1.2 Tsi 2010>0, Leon Box Body / Hatchback 1.4 Tsi 2012>0, Leon Box Body / Hatchback 1.6 Tdi 2010>0, Leon Box Body / Hatchback 1.8 Tfsi 2012>0, Leon Box Body / Hatchback 2.0 Cupra 2013>0, Leon Box Body / Hatchback 2.0 Tdi 2010>0, Leon Sc 1.0 Tsi 2015>0, Leon Sc 1.2 Tsi 2010>0, Leon Sc 1.4 Tsi 2012>0, Leon Sc 1.6 Tdi 2010>0, Leon Sc 1.8 Tsi 2012>0, Leon Sc 2.0 Cupra 2013>0, Leon Sc 2.0 Tdi 2010>0, Leon St 1.0 Tsi 2015>0, Leon St 1.2 Tsi 2010>0, Leon St 1.4 Tgi 2013>0, Leon St 1.4 Tsi 2012>0, Leon St 1.6 Tdi 2010>0, Leon St 1.8 Tsi 2012>0, Leon St 2.0 Cupra 2013>0, Leon St 2.0 Tdi 2010>0, Leon St Box Body/Estate 1.0 Tsi 2015>0, Leon St Box Body/Estate 1.2 Tsi 2010>0, Leon St Box Body/Estate 1.4 Tsi 2012>0, Leon St Box Body/Estate 1.6 Tdi 2010>0, Leon St Box Body/Estate 1.8 Tfsi 2012>0, Leon St Box Body/Estate 2.0 Cupra 2013>0, Leon St Box Body/Estate 2.0 Tdi 2010>0;

SKODA: Karoq 1.0 Tsi 2015>0, Karoq 1.5 Tsi 2017>0, Karoq 1.6 Tdi 2010>0, Karoq 2.0 Tdi 2010>0, Octavia lli 1.0 Tsi 2015>0, Octavia lli 1.2 Tsi 2010>0, Octavia lli 1.4 Tsi 2012>0, Octavia lli 1.4 Tsi G-Tec 2013>0, Octavia lli 1.5 Tsi 2017>0, Octavia lli 1.6 Tdi 2010>0, Octavia lli 1.6 Tdi 2010>0, Octavia lli 1.8 Tsi 2012>0, Octavia lli 2.0 Tdi 2010>0, Octavia lli 2.0 Tdi Rs 2013>0, Octavia lli 2.0 Tsi 2015>0, Octavia lli 2.0 Tsi Rs 2012>0, Octavia lli Combi 1.0 Tsi 2015>0, Octavia lli Combi 1.2 Tsi 2010>0, Octavia lli Combi 1.4 Tsi 2012>0, Octavia lli Combi 1.4 Tsi G-Tec 2013>0, Octavia lli Combi 1.5 Tsi 2017>0, Octavia lli Combi 1.5 Tsi G-Tec 2019>0, Octavia lli Combi 1.6 Tdi 2010>0, Octavia lli Combi 1.6 Tdi 2010>0, Octavia lli Combi 1.8 Tsi 2012>0, Octavia lli Combi 2.0 Tdi 2010>0, Octavia lli Combi 2.0 Tdi Rs 2013>0, Octavia lli Combi 2.0 Tsi 2015>0, Octavia lli Combi 2.0 Tsi Rs 2012>0, Superb lli 1.4 Tsi 2012>0, Superb lli 1.4 Tsi Iv 2019>0, Superb lli 1.5 Tsi 2017>0, Superb lli 1.6 Tdi 2010>0, Superb lli 1.8 Tsi 2012>0, Superb lli 2.0 Tdi 2010>0, Superb lli 2.0 Tsi 2015>0, Superb lli Estate 1.4 Tsi 2012>0, Superb lli Estate 1.4 Tsi Iv 2019>0, Superb lli Estate 1.5 Tsi 2017>0, Superb lli Estate 1.6 Tdi 2010>0, Superb lli Estate 1.8 Tsi 2012>0, Superb lli Estate 2.0 Tdi 2010>0, Superb lli Estate 2.0 Tsi 2015>0;

VW: Artoon 1.5 Tsi 2017>0, Artoon 2.0 Tdi 2010>0, Artoon 2.0 Tsi 2015>0, Caddy Alltrack Box 1.0 Tsi 2015>0, Caddy Alltrack Box 1.2 Tsi 2010>0, Caddy Alltrack Box 1.4 Tsi 2012>0, Caddy Alltrack Box 1.6 Tdi 2010>0, Caddy Alltrack Box 2.0 Tdi 2010>0, Caddy Alltrack Estate 1.0 Tsi 2015>0, Caddy Alltrack Estate 1.2 Tsi 2010>0, Caddy Alltrack Estate 1.4 Tgi Cng 2013>0, Caddy Alltrack Estate 1.4 Tsi 2012>0, Caddy Alltrack Estate 1.6 Tdi 2010>0, Caddy Alltrack Estate 2.0 Tdi 2010>0, Caddy lli Box 1.2 Tsi 2010>0, Caddy lli Box 1.6 2004>0, Caddy lli Box 1.6 2004>0, Caddy lli Box 1.6 Bifuel 2011>0, Caddy lli Box 1.6 Tdi 2010>0, Caddy lli Box 1.6 Tdi 2010>0, Caddy lli Box 2.0 Ecofuel 2006>0, Caddy lli Box 2.0 Tdi 2010>0, Caddy lli Box 2.0 Tdi 16V 2010>0, Caddy lli Box 2.0 Tdi 4Motion 2010>0, Caddy lli Estate 1.2 Tsi 2010>0, Caddy lli Estate 1.6 2004>0, Caddy lli Estate 1.6 Bifuel 2011>0, Caddy lli Estate 1.6 Tdi 2010>0, Caddy lli Estate 2.0 Ecofuel 2006>0, Caddy lli Estate 2.0 Tdi 2010>0, Caddy lli Estate 2.0 Tdi 16V 2010>0, Caddy Iv Box 1.0 Tsi 2015>0, Caddy Iv Box 1.2 Tsi 2010>0, Caddy Iv Box 1.4 Tgi Cng 2013>0, Caddy Iv Box 1.4 Tsi 2012>0, Caddy Iv Box 1.6 2004>0, Caddy Iv Box 1.6 Tdi 2010>0, Caddy Iv Box 2.0 Tdi 2010>0, Caddy Iv Estate 1.0 Tsi 2015>0, Caddy Iv Estate 1.2 Tsi 2010>0, Caddy Iv Estate 1.4 Tgi Cng 2013>0, Caddy Iv Estate 1.4 Tsi 2012>0, Caddy Iv Estate 1.6 2004>0, Caddy Iv Estate 1.6 Tdi 2010>0, Caddy Iv Estate 2.0 Tdi 2010>0, Crafter Box 2.0 Tdi 2010>0, Crafter Box 2.0 Tdi 4Motion 2010>0, Crafter Box 2.0 Tdi Rwd 2017>0, Crafter Bus 2.0 Tdi 2010>0, Crafter Bus 2.0 Tdi 4Motion 2010>0, Crafter Platparam/Chassis 2.0 Tdi 2010>0, Crafter Platparam/Chassis 2.0 Tdi 4Motion 2010>0, Golf Alltrack Vii 1.8 Tsi 4Motion 2014>0, Golf Alltrack Vii 2.0 Tdi 4Motion 2010>0, Golf Sportsvan 1.0 Tsi 2015>0, Golf Sportsvan 1.2 Tsi 2010>0, Golf Sportsvan 1.4 Tsi 2012>0, Golf Sportsvan 1.4 Tsi Multifuel 2013>0, Golf Sportsvan 1.5 Tsi 2017>0, Golf Sportsvan 1.6 2004>0, Golf Sportsvan 1.6 Tdi 2010>0, Golf Sportsvan 2.0 Tdi 2010>0, Golf Van Vii Variant 1.2 Tsi Bluemotion 2012>0, Golf Van Vii Variant 1.4 Tsi Bluemotion 2012>0, Golf Van Vii Variant 1.6 Tdi Bluemotion 2012>0, Golf Van Vii Variant 2.0 Tdi Bluemotion 2013>0, Golf Vii 1.0 Tsi 2015>0, Golf Vii 1.2 Tsi 2010>0, Golf Vii 1.4 Gte Hybrid 2014>0, Golf Vii 1.4 Tgi Cng 2013>0, Golf Vii 1.4 Tsi 2012>0, Golf Vii 1.4 Tsi Multifuel 2013>0, Golf Vii 1.5 Tgi 2018>0, Golf Vii 1.5 Tsi 2017>0, Golf Vii 1.6 2004>0, Golf Vii 1.6 Tdi 2010>0, Golf Vii 2.0 Gtd 2013>0, Golf Vii 2.0 Gti 2013>0, Golf Vii 2.0 Gti Clubsport 2016>0, Golf Vii 2.0 Gti Clubsport S 2016>0, Golf Vii 2.0 Gti Tcr 2019>0, Golf Vii 2.0 Tdi 2010>0, Golf Vii E-Golf 2014>0, Golf Vii Van 1.2 Tsi Bluemotion 2012>0, Golf Vii Van 1.4 Tsi Bluemotion 2012>0, Golf Vii Van 1.6 Tdi Bluemotion 2012>0, Golf Vii Van 2.0 Gtd 2013>0, Golf Vii Van 2.0 Gti 2013>0, Golf Vii Van 2.0 Tdi Bluemotion 2013>0, Golf Vii Variant 1.0 Tsi 2015>0, Golf Vii Variant 1.2 Tsi 2010>0, Golf Vii Variant 1.4 Tgi Cng 2013>0, Golf Vii Variant 1.4 Tsi 2012>0, Golf Vii Variant 1.4 Tsi Multifuel 2013>0, Golf Vii Variant 1.5 Tgi 2018>0, Golf Vii Variant 1.5 Tsi 2017>0, Golf Vii Variant 1.6 2004>0, Golf Vii Variant 1.6 Tdi 2010>0, Golf Vii Variant 2.0 Gtd 2013>0, Golf Vii Variant 2.0 Tdi 2010>0, Golf Viii 1.5 Tsi Bluemotion 2019>0, Golf Viii 2.0 Tdi Bluemotion 2013>0, Golf Viii 1.0 Tsi 2015>0, Golf Viii 1.5 Etsi 2019>0, Grand Caliparania Camper 2.0 Tdi 2010>0, Grand Caliparania Camper 2.0 Tdi 4Motion 2010>0, Passat 1.4 Gte Hybrid 2014>0, Passat 1.4 Tsi 2012>0, Passat 1.5 Tsi 2017>0, Passat 1.6 Tdi 2010>0, Passat 1.8 Tsi 2012>0, Passat 2.0 Tdi 2010>0, Passat 2.0 Tsi 2015>0, Passat Variant 1.4 Gte Hybrid 2014>0, Passat Variant 1.4 Tsi 2012>0, Passat Variant 1.5 Tsi 2017>0, Passat Variant 1.6 Tdi 2010>0, Passat Variant 1.8 Tsi 2012>0, Passat Variant 2.0 Tdi 2010>0, Passat Variant 2.0 Tdi 4Motion 2010>0, Passat Variant 2.0 Tsi 2015>0, Tiguan 1.4 Tsi 2012>0, Tiguan 1.5 Tsi 2017>0, Tiguan 1.6 Tdi 2010>0, Tiguan 2.0 Tdi 2010>0, Touran 1.0 Tsi 2015>0, Touran 1.2 Tsi 2010>0, Touran 1.4 Tsi 2012>0, Touran 1.5 Tsi 2017>0, Touran 1.6 Tdi 2010>0, Touran 1.8 Tsi 2012>0, Touran 2.0 Tdi 2010>0, T-Roc 1.0 Tsi 2015>0, T-Roc 1.5 Tsi 2017>0, T-Roc 1.6 Tdi 2010>0, T-Roc 2.0 Tdi 2010>0



EMS COMPONENTS | SISTEMA DE CONTROL DE MOTOR

OXYGEN SENSOR | SENSOR DE OXÍGENO

UNIVERSAL
G08022

FEATURES / CARACTERÍSTICAS: 02 wires, Length 22 cm, Universal.

REPLACES / REEMPLAZA:
Walker: 250-22000

APPLICATION / APLICACIÓN:

AMERICAN MOTORS: AMX 80 4.2, Concord 80 4.2 /82-80 2.5, Spirit 80-82 2.5 /80 4.2, Pacer 80 4.2;
BUICK: Century 81-80 3.8 /4.3 /80 4.9 /80 5.0, Electra 81-80 4.1 /81 5.0 /80 4.9 /5.7, LeSabre 81-80 4.1 /81 5.0 /80 4.9 /5.7, Regal 81-80 3.8 /80 4.9 /5.0, Riviera 81-80 3.8 /5.0 /81 4.1 /80 5.7, Skyhawk 80 3.8, Skylark 81-80 2.5 /2.8;
CADILLAC: Allante 92-89 4.5 /88-87 4.1, DeVille 95-94 4.9 /90-88 4.5 /84-82 4.1 /81-80 4.1 /6.0, Eldorado 93-91 4.9 /90-88 4.5 /87 4.1 /84-82 4.1 /81-80 6.0 /81 4.1 ;
 Fleetwood 92-91 4.9 /90-88 4.5 /87-86 4.1 /84-82 4.1 /84-80 6.0 /81-80 4.1, Seville 93-91 4.9 /90-88 4.5 /84-82 4.1 /81-80 6.0 /81 4.1 ;
CHEVROLET: Camaro 81-80 3.8 /5.0 /5.7 /2000-98 3.8, Caprice 81-80 3.8 /80 5.0, Cavalier 2001-2000 2.2, Pickup S10 2003-2000 2.2, Chevette 81-80 1.6, Citation 81-80 2.5 /2.8, Corvette 81-80 5.7 /80 5.0, El Camino 81-80 3.8 /5.0, Impala 81-80 3.8 /80 5.0, Malibu 81-80 3.8 /5.0 /5.7, Monte Carlo 81-80 3.8 /5.0, Monza 80 2.5 /3.8;
DAEWOO: Lanos 2002-99 1.6, Leganza 2002-99 2.2, Nubira 2002-99 2.0;
GMC: Caballero 81-80 3.8 /5.0;
JEEP: CJ5 82-80 2.5, CJ7 82-80 2.5, Scrambler 82-81 2.5;
OLDSMOBILE: 98 81 5.0 /80 5.7, Alero 2001-2000 2.4, Custom Cruiser 80 5.7, Cutlass 81-80 3.8 /4.3 /80 5.7, Cutlass Calais 81-80 3.8, Cutlass Cruiser 81-80 3.8 /81 5.0, Cutlass Salon 80 3.8 /4.3, Cutlass Supreme 81-80 3.8, Delta 88 81-80 3.8 /80 5.7, Firenza 82 1.8, Omega 81-80 2.5 /2.8, Starfire 80 2.5 /3.8, Soroma 2003-2000 2.2, Toronado 81 5.0 /80 5.7;
PONTIAC: Bonneville 81-80 3.8 /4.3 /81 5.0 /80 4.9 /5.7, Catalina 81-80 3.8 /4.3 /81 5.0 /80 4.9 /5.7, Firebird 81-80 3.8 /4.9 /5.0 /81 4.3, Grand Am 80 4.9 /5.0 /2001-2000 2.4, Grand LeMans 81-80 3.8 /4.3 /4.9 /80 5.0, Grand Prix 81-80 3.8 /4.3 /80 4.9 /5.0, J2000 82 1.8, LeMans 81-80 3.8 /4.3 /4.9 /80 5.0, Phoenix 81-80 2.5 /2.8, Sunbird 80 2.5 /3.8, Sunfire 2002-2000 2.4 /2001-2000 2.2;
DODGE: Colt 94-93 1.5 /94-93 1.8 /92 1.5 /91-90 1.5 /91-89 2.0 /90 1.5 /90 1.6 /89 1.5, Ram 50 93 2.4 /92-91 2.4 /90 2.4, Raider 89 3.0, Summit 91-90 1.5 /90 1.6 /89 1.5;
EAGLE: Summit 94-93 1.5 /94 1.8 /93 1.8 /2.4 /92 1.5 /1.8 /2.4 /91 1.5, Talon 94-93 1.8;
HYUNDAI: Excel 92 1.5 /91-90 1.5, Scoupe 93-91 1.5, Sonata 91-89 2.4;
MITSUBISHI: Eclipse 94-91 1.8 /94-90 2.0 /90 1.8, Expo 93 2.4 /92 2.4, Expo LRV 93 1.8 /2.4 /92 1.8, Galant 93 2.0 /88 3.0 /93 2.0 /92-89 2.0, Mighty Max 95-93 2.4 /92-91 2.4 /90 2.4, Mirage 93 1.5 /1.8 /92-91 1.5 /90-89 1.5, Montero 89 3.0, Precis 92-90 1.5, Sigma 90-89 3.0;
PLYMOUTH: Colt 94-93 1.5 /1.8 /93 2.4 /92 1.5 /1.8 /2.4 /91-90 1.5 /91-89 2.0 /90 1.5 /1.6 /89 1.5, Laser 94-91 1.8 /90 1.8;
GEO: Prizm 97-96 1.6 /97-95 1.8 /92-90 1.6;
TOYOTA: Camry 91-90 2.0 /2.5 /89-88 2.5 /96 2.2 /95-94 2.2 /93-92 2.2, Celica 91-90 2.2 /89 2.0 /99-96 2.2 /95 2.2 /94 2.2 /93-92 2.2 /97-96 1.8, Corolla 89 1.6 /97-96 1.6 /97-95 1.8, MR2 92 2.2 /91 2.2 /95-93 2.2 /92 2.2, Paseo 98-97 1.5, RAV4 97 2.0 /96 2.0, Tercel 98-97 1.5;
MAZDA: B2200 93-90 2.2, B2600 93-89 2.6, MPV 94-89 2.6;
LEXUS: ES250 91-90 2.5, LS400 92-90 4.0 /94-93 4.0;
JAGUAR: Vanden Plas 98 4.0, XJ8 98 4.0, XJR 98 4.0;
SATURN: L100 2001 2.2, LS 2000 2.2, LS1 2000 2.2, LW1 2000 2.2, LW200 2001 2.2;

UNIVERSAL
G08023

FEATURES / CARACTERÍSTICAS: 03 wires, Length 22 cm, Universal.

REPLACES / REEMPLAZA:
Walker: 250-23000

APPLICATION / APLICACIÓN:

FORD: Aerostar 87-86 2.3 /91-86 3.0, Bronco 89-88 5.8 /89-87 4.9 /5.0, Bronco II 86 2.9 /90 5.0 /90 2.9 /89-87 2.9, Country Squire 91-87 5.0, Escort 91-87 1.9, EXP 88-86 1.9, F53 91-88 7.5, LTD 86 5.0, LTD Crown Victoria 91-87 5.0, Mustang 86-84 2.3 /93-91 5.0 /90-85 5.0 /90 2.3 /89-87 2.3, Pickup F-150 90-87 5.0 /89-87 4.9 /89-88 5.8, Pickup F-250 92-90 7.5 /90 5.0 /89-88 5.8 /89-88 7.5 /89-87 4.9, Pickup F-350 92-90 7.5 /89-88 5.8 /89-88 7.5 /89-87 4.989-87 5.0, Pickup F Super Duty 91-90 7.5, Probe 92-90 2.2 /92-90 3.0 /97 2.5 /96 2.5, Ranger 86-85 2.3 /86 2.9 /90 2.3 /89-87 2.3 /88-87 2.9 /92-89 2.9, Taurus 86 3.0 /95-91 3.0 /90-88 3.8 /90-87 3.0 /90-87 2.5, Tempo 91-87 2.3, Thunderbird 84 2.3 /90-88 3.8 /89 3.8 /88-87 2.3 /88-87 5.0, Van E-150 Series 86 5.0 /89-88 5.8 /89-87 4.9 /89-87 5.0, Van E-250 Series 86 5.0 /90 5.0 /89-87 4.9 /89-87 5.0 /89-88 5.8 /90-88 7.5, Van E-350 Series 89-87 4.9 /92-90 7.5 /89-88 5.8 /89-87 7.5;
LINCOLN: Continental 86 5.0 /90-88 3.8 /87 5.0, Mark VII 87-85 5.0 /92-88 5.0, Town Car 90-86 5.0;
MERCURY: Capri 86-84 5.0 /84 2.3, Colony Park 91-87 5.0, Cougar 88-86 5.0 /84 2.3 /90-88 3.8, Grand Marquis 91-86 5.0, Lynx 87-86 1.9, Sable 86 3.0 /90-88 3.0 /3.8, Topaz 91-87 2.3, Tracer 91 1.9;
MERKUR: Scorpio 89 2.9;
MAZDA: 626 97 2.5 /96 2.5 /99-96 2.0, 929 91-88 3.0, B2300 94 2.3, Millenia 96-95 2.5 /2002-95 2.3, MPV 91 3.0, MX-3 95-94 1.6, MX-6 97 2.5 /96 2.5, Protege 98-95 1.5 /96 1.5;
BUICK: Park Avenue 93 3.8, Regal 93 3.8;
CHEVROLET: Astro 95 4.3, Lumina APV 93 3.8, Pickup C1500 95 4.3 /5.0 /5.7, Pickup C2500 95 5.0 /5.7, Pickup K1500 95 4.3 /5.0 /5.7, Pickup K2500 95 4.3 /5.0 /5.7, Suburban C1500 95 5.7, Suburban C2500 95 5.7, Suburban K1500 95 5.7, Suburban K2500 95 5.7, Tahoe 95 5.7, Van G10 95 4.3, Van G20 95 4.3, Van G30 95 4.3;
GMC: Pickup C1500 95 4.3 /5.0 /5.7, Pickup C2500 95 5.0 /5.7, Pickup K1500 95 4.3 /5.0 /5.7, Pickup K2500 95 4.3 /5.0 /5.7, Safari 95 4.3, Van G1500 95 4.3, Van G2500 95 4.3, Van G3500 95 4.3, Yukon 95 5.7;
OLDSMOBILE: 98 93 3.8, Silhouette 93 3.8;
PONTIAC: Trans Sport 93 3.8;
VW: Cabriolet 93-90 1.8, Corrado 92-91 1.8, EuroVan 95 2.5 /93 2.5, Fox 93-91 1.8, Golf 92-88 1.8, Jetta 92-88 1.8;
BMW: 318i 85 1.8, 325 88 2.7, 325e 87-84 2.7, 325es 87-86 2.7, 533i 86-85 3.5, 535i 87 3.5, 635CSi 87-85 3.5, 735i 85 3.5, L6 87 3.5, M3 91-88 2.3, M5 88 3.5, M6 88-87 3.5;
PORSCHE: 911 94-89 3.6 /92-91 3.3 /89-86 3.3 /89-86 3.2, 924 88-87 2.5, 928 95-93 5.4 /91-88 5.0, 944 91-89 3.0 /89-86 2.5, 89 2.7 /88-86 2.5, 968 95-92 3.0;
SUBARU: Forester 99-98 2.5, Impreza 98 2.2 /2.5 /95-93 1.8 /99 2.2 /2.5, Legacy 94-90 2.2 /99 2.2 /2.5 /98-96 2.2 /2.5 /96 2.5, SVX 97-92 3.3;
KIA: Sephia 97-96 1.6 /95 1.6, Sportage 95 2.0;
SUZUKI: Sidekick 93-92 1.6;
INFINITI: I35 2004-2002 3.5, QX4 2003-2002 3.5;
NISSAN: Altima 2004-2002 3.5, Maxima 2003-2002 3.5, Pathfinder 2002-2001 3.5, Sentra 2001 1.8;

UNIVERSAL
GO8024

FEATURES / CARACTERÍSTICAS: 04 wires, Length 22 cm, Universal.

REPLACES / REEMPLAZA:

Walker: 250-24000

APPLICATION / APLICACIÓN:

ACURA: SLX 99-98 3.5 /97-96 3.2;

BUICK: Century 2004-94 3.1, LeSabre 96-2003 3.1, Park Avenue 2003-94 3.1, Regal 96-93 3.1 /2003-93 3.8, Rendezvous 2005-2002 3.4, Riviera 99-95 3.8, Roadmaster 96-94 5.7, Skylark 98-94 3.1 /98-96 2.4;

CADILLAC: Escalade 2002 5.3 /2000-99 5.7, Fleetwood 96-94 5.7;

CHEVROLET: Astro 97-96 4.3, Avalanche 1500 2002 5.3, Beretta 96-94 3.1 /96 2.2, Blazer 2001-95 4.3, Blazer S10 94 4.3, Camaro 2002-93 5.7 /2002-95 3.8, Caprice 96-94 4.3 /5.7, Cavalier 2002-96 2.4, Corsica 96-94 3.1 /96 2.2, Corvette 2003-94 5.7, Impala 96-94 5.7 /2004-2001 3.4 /2003-2000 3.8 /2000 3.4, Lumina 96-95 3.1 /3.4 /94 3.4 /2001-97 3.1 /99-98 3.8 /97 3.4 /96 3.1, Lumina APV 96 3.4 /95-94 3.8, Malibu 2003-97 3.1 /99-97 2.4, Monte Carlo 99-95 3.1 /97-95 3.4 /2004-2001 3.4 /2003-98 3.8 /2000 3.4, Pickup C1500 99-96 5.0 /5.7 /98-96 4.3, Pickup C2500 98-96 5.0 /5.7 /2000-96 5.7 /99-96 7.4, Pickup C3500 2000-96 5.7 /99-96 7.4, Pickup K1500 99-96 5.0 /5.7 /98-96 4.3, Pickup K2500 98-97 5.0 /5.7 /2000-99 5.7 /99-96 7.4, Pickup K3500 2000-96 5.7 /99-96 7.4, Pickup S10 2001-99 4.3 /98-94 4.3 /96 2.2 /2003-97 2.2, Silverado 1500 2002-99 4.8 /5.3 /2002-99 4.3, Silverado 1500 HD 2001 6.0, Silverado 2500 2000-99 5.3 /6.0 /2001 6.0, Silverado 2500 HD 2001 6.0, Silverado 3500 2001 6.0, Suburban 1500 2002-2000 5.3 /2000-2001 6.0, Suburban C1500 99-96 5.7, Suburban C2500 99-97 5.7 /99-96 7.4, Suburban K1500 99-96 5.7, Suburban K2500 99-96 5.7 /7.4, Tahoe 2002-2000 4.8 /5.3 /2000-96 5.7, Van Express 1500 2002-96 5.0 /2002-96 4.3 /2002-96 5.7, Van Express 2500 2002-96 5.0 /2002-96 4.3 /2002-96 5.7, Van G30 96 7.4, Van P30 99-95 4.3 /99-96 5.7 /7.4, Venture 2004-97 3.4;

DAEWOO: Lanos 2002-99 1.6, Leganza 2002-99 2.2;

GMC: Jimmy 2001-94 4.3, Safari 97-96 4.3, Savana 1500 2002-98 4.3 /5.0 /97-96 4.3, Savana 2500 2002-98 4.3 /5.0 /5.7, Savana 3500 2000-96 7.4, Sierra 1500 2002-2000 4.8 /5.3 /2002-99 4.3 /99 4.8 /5.3, Sierra 1500 HD 2001 6.0, Sierra 2500 2000-99 5.3 /2001 6.0, Sierra 2500 HD 2001 6.0, Sierra 3500 2001 6.0, Sierra C3 2001 6.0, Sonoma 2001-94 4.3 /2003-96 2.2, Van P3500 95 4.3;

Yukon 2002-2000 4.8 /5.3 /99-96 5.7 /2001 6.0, Yukon XL 1500 2002-2000 5.3 /2001 6.0, Yukon XL 2500 2001-2000 6.0;

HONDA: Passport 2000-96 3.2, 96 2.6;

ISUZU: Amigo 2000-98 2.2 /3.2, Hombre 2000-97 4.3 /2000-96 2.2, Rodeo 2003-98 2.2 /2000-96 3.2 /97-96 2.6, Rodeo Sport 2003-2001 2.2, Trooper 99-98 3.5 /97-96 3.2, VehiCROSS 2001-99 3.5;

OLDSMOBILE: 88 97-94 3.8, 98 96-94 3.8, Achieva 98-94 3.1 /98-96 2.4, Alero 2004-99 3.4 /2001-99 2.4, Aurora 99-96 4.0, Bravada 2001-96 4.3, Cutlass 99-97 3.1, Cutlass Ciera 96-94 3.1 /96 2.2, Cutlass Supreme 97-93 3.1 /3.4, Intrigue 99-98 3.8 /99 3.5, LSS 99-96 3.8, Regency 98-97 3.8, Silhouette 96-94 3.8 /2004-96 3.4;

PONTIAC: Aztek 2004-2001 3.4, Bonneville 2003-96 3.8, Firebird /2002-95 3.8 /2002-94 5.7, Grand Am 98-94 3.1 /2001-96 2.4 /2005-2001 3.4, Grand Prix 96-94 3.1 /2003-94 3.4, Montana 2004-99 3.4, Sunfire 2002-99 2.4 /98-96 2.2, Trans Sport 98-94 3.4;

CADILLAC: DeVille 99-96 4.6, Eldorado 99-96 4.6, Seville, 99-96 4.6, Camaro 2002-98 5.7;

INFINITI: Q45 96 4.5, QX4 2000-97 3.3, G20 99 2.0, I30 99-97 3.0;

NISSAN: 200SX 98 2.0, 300ZX 96 3.0, Frontier 2003-99 3.3, Maxima 99-97 3.0, Quest 2000-99 3.3 /98-96 3.0, Pathfinder 2000-96 3.3, Xterra 2003-2000 3.3;

PORSCHE: Cayenne 2012-2011 4.8;

FORD: Probe 97 2.5;

MAZDA: 626 2000-97 2.5 /99-98 2.0, Millenia 2002-95 2.3 /96-95 2.5, MX-6 97 2.5;

LEXUS: SC400 95-92 4.0;

SATURN: L100 2001 2.2, LS 2000 2.2, LS1 2000 2.2, LW1 2000 2.2, LW200 2001 2.2;

DAEWOO: Nubira 2002-99 2.0;

MERCURY: Villager 99 3.3 /98-96 3.0;

UNIVERSAL
GO8050

FEATURES / CARACTERÍSTICAS: 01 wire, Length 21 cm, Universal.

REPLACES / REEMPLAZA:

Walker: 250-21050

APPLICATION / APLICACIÓN:

TOYOTA: 4Runner 88-84 2.4, Camry 91-87 2.0 /95-92 2.2 /93-92 3.0, Celica 95-94 1.8 /95-90 2.2 /89-86 2.0 /85-81 2.4 /86-81 2.8, Corolla 89-83 1.6 /80 1.8 /95-93 1.6 /94-93 1.8, Corona 82-81 2.4, Cressida 92-89 3.0 /88-81 2.8, MR2 95-91 2.2 /87-85 1.6, Pickup 88-81 2.4 /80 2.2, Starlet 84-83 1.3, Supra 92-86 3.0 /95-93 3.0, Tercel 90-80 1.5, Van 87-85 2.2;

GEO: Prizm 95-93 1.6 /94-93 1.8, LEXUS: ES300 93-92 3.0, GS300 94-93 3.0, SC300 94-92 3.0;

CHEVROLET: Nova 88-85 1.6;

DAIHATSU: Charade 92-89 1.3 /92-88 1.0, Rocky 92-90 1.6;

CHRYSLER: Conquest 89-87 2.6;

DODGE: Conquest 86-84 2.6;

MITSUBISHI: Starion 89-83 2.6;

PLYMOUTH: Conquest 86-84 2.6;

UNIVERSAL
GO8430

FEATURES / CARACTERÍSTICAS: 04 wires, Length 100 cm, Universal.

Except planar systems and / or CNG and / or Honda Civic.

REPLACES / REEMPLAZA:

.

APPLICATION / APLICACIÓN:

FIAT, FORD, VW, GM: Universal IMPORTADOS: Universal

UNIVERSAL
G08131

FEATURES / CARACTERÍSTICAS: 01 wire, Length 20 cm - Universal.

Except planar systems and / or CNG.

REPLACES / REEMPLAZA:

Original: 25.106.073, 93.232.414; **Delphi:** SOD00139

APPLICATION / APLICACIÓN:

GM: Astra 1.8 (2.0 (MPFI) 99>, Blazer, S10 2.2 (EFI - MPFI) 95>, Celta 1.0 (MPFI) 01>, Corsa 1.0 /1.4 /1.6 (EFI - MPFI) 94>, Ipanema, Kadett 2.0 (MPFI) 97>, Omega, Vectra 2.2 (MPFI) 96>, Zafira 2.0 8V 02>.

BOSCH
G08592 // NEW //

FEATURES / CARACTERÍSTICAS:

REPLACES / REEMPLAZA:

BOSCH: 0 281 004 019; **BMW:** 13 62 7 791 592; **MEAT&DORIA:** 81577

APPLICATION / APLICACIÓN:

BMW: 330d/335d 2012>2018, 430d/435d 2013>

FIAT
G08303

FEATURES / CARACTERÍSTICAS: 03 wires, Length 100 cm.

Except planar systems and / or CNG.

REPLACES / REEMPLAZA:

Original: 7.619.303; **NTK:** OZA 446-E4

APPLICATION / APLICACIÓN:

FIAT: Elba, Prêmio, Uno 1.5 8V (SPI) 92>96.

FIAT
G08448

FEATURES / CARACTERÍSTICAS: 04 wires, Length 40 cm.

Except planar systems and / or CNG.

REPLACES / REEMPLAZA:

Original: 7.527.493, 7.529.275; **NTK:** OZA114-A1

APPLICATION / APLICACIÓN:

FIAT: Elba, wirerino, Prêmio 1.5 8V (SPI) 92>96, wirerino Pick-up LX 1.6 8V (MPI) 95>96, Tempra 2.0 8/16V (MPI / SPI) 95>99, Uno 1.0 /1.5 8V (SPI) 92>01, Uno 1.6 8V (MPI) 95>96.

FIAT
G08466

FEATURES / CARACTERÍSTICAS: 04 wires, Length 90 cm.

Except planar systems and / or CNG.

REPLACES / REEMPLAZA:

Original: 7.668.266, 7.688.286; **NTK:** OZA 448-E4

APPLICATION / APLICACIÓN:

FIAT: Tempra Ouro 2.0 16V (MPI) 93>94, Tempra SW SLX 2.0 8V (MPI) 94>97, Tipo 1.6 8V (MPI) 96>97, Tipo 2.0 8/16V (MPI) 94>95.

FIAT
G08468

FEATURES / CARACTERÍSTICAS: 04 wires, Length 100 cm.

Except planar systems and / or CNG.

REPLACES / REEMPLAZA:

Original: 46.417.969, 46.444.284, 46.447.841, 46.523.129, 46.529.385, 46.481.457, 46.481.458, **NTK:** OZA112-A4, OZA334-A3, OZA448-E7

APPLICATION / APLICACIÓN:

FIAT: Brava 1.6 /1.8 16V (MPI) 00>03, Doblò 1.6 16V (MPI) 02>03, wirerino /Furgão, Palio EX 1.3 8V (MPI) 03>, wirerino Pick-up 1.5 8V (MPI) 97>99, Uno 1.5 8V (MPI) 97>, Marea 1.8 16V (MPI) 00>, Marea SX 1.6 16V (MPI) 06> /Weekend 2.0 20V (MPI) 99>00 /Weekend 2.0 20V Turbo (MPI) 99>02, Palio 1.0 8V (MPI) 98>02, Uno 1.0 8V (MPI) 01>, Palio 1.6 8V (SPI) 98>99, Siena 1.0 /1.5 /1.6 8 /16V (MPI) 96>04, Strada 1.3 8V (MPI) 03>05, Palio Weekend 1.5 /1.6 8/16V (MPI) 97>, Siena Fire 1.0 8V (MPI) 02>03 /1.6 8V (SPI) 98>99, Siena 1.5 8V (MPI) 03>04, Strada 1.5 /1.6 8/16V (MPI) 99>, Strada Fire 1.3 8V (MPI) 03>, Tempra 2.0 8V Turbo (MPI) 95>98, Tempra SW 2.0 8V (MPI) 94>97, Tipo 1.6 8V (SPI) 93>95, Tipo 2.0 16V (MPI) 94, Uno 1.3 (Fire) 8V (MPI), Uno Mille 1.0 8V (MPI) 99>03.

FORD / VW
G08454

FEATURES / CARACTERÍSTICAS: 04 wires, Length 70 cm.

Except planar systems and / or CNG.

REPLACES / REEMPLAZA:

Original: 026.906.265.4, 026.906.265.5, 026.906.265.6, 027.906.265.3, 027.906.265.4, 027.906.265.5, 1S7F-9F472-AB, 98AB-9F472-BB, F4AZ-9F472-B, F4UZ-9F472-C, F77Z-9F472-BA, F88Z-9F472-BA, XL3Z-9F472-AA, XL3Z-9F472-BA

APPLICATION / APLICACIÓN:

FORD: Escort 1.6 /1.8 AP (CFI) /2.0 AP (EFI) 94>96, F250 4.2L V6 (EFI – OHV) 98>, Focus 1.6 /1.8 /2.0 16V (Zetec) 00>05, Pampa 1.8 AP (CFI) 96>97, Ranger 2.3L 4 cilindros /4.0L V6 94>97, Ranger 2.3L /2.5L /4.0L 97>01, Ranger 2.3L /4.0 V6 (SOHC) 01>03, Royale, Verona, Versailles 1.8 AP (CFI) /2.0 AP (EFI) 94>96, Royale, Versailles 1.8 AP /2.0 AP 93>96;

IMPORTADOS: Explorer 4.0L V6 XLT 92>97, Explorer 4.0L V6 (OHV) 04>, Explorer Limited 5.0L V8 (OHV) 98>, Mondeo 2.0L (Zetec – E) 98>01, Mondeo 2.5 16V (Duratec) 01> /Sedan 2.5L V6 (DOHC) 99>01, Taurus 3.0 V6 (DOHC) 94>97;

VW: Gol 1.0 AE /1.6 AP /1.8 AP (CFI) 94>96, Gol, Logus, Parati, Pointer 2.0 AP (EFI) 94>97, Logus 1.6 /1.8 /2.0 AP (CFI) 94>96, Parati 1.6 /1.8 (CFI) 95>97, Pointer 1.8 /2.0 AP (CFI) 94>96, Quantum, Santana 1.8 AP /2.0 AP (EFI) 93>97.

FORD
G08472

FEATURES / CARACTERÍSTICAS: 04 wires, Length 75 cm.

Except planar systems and / or CNG.

REPLACES / REEMPLAZA:

Original: 2S65-9F472-AB, 2S65-9F472-AC, 93AB-9F472-AA, 93BB-9F472-AA, 96FB-9F472-CA, 96FB-9F472-DA, 96VB-9F472-DA, 96VB-9F472-DB, F5RZ-9F472-B

APPLICATION / APLICACIÓN:

FORD: Courier, Fiesta, Ka 1.0 /1.3 (Endura – E) 97>99, Ka 1.0 /1.6 (Zetec Rocan) 99>, Courier, Fiesta 1.4L 16V (Zetec – SE) 96>99, EcoSport 1.0 /1.6 (Zetec Rocan) 03>, EcoSport 2.0L (Duratec E) 03>, Escort 1.6L (Zetec Rocan) 00>02, Escort 1.8L 16V (Zetec) 96>02, F1000 4.9L 98, Focus 2.0L (Duratec HE) 05;

IMPORTADOS: Mondeo 1.8 /2.0 94>96, Mondeo 2.0L (Zetec – E) 96>98, Mondeo Sedan 2.5L V6 (DOHC) 98>99.

GM
G08130

FEATURES / CARACTERÍSTICAS: 01 wire, Length 40 cm - purple wire.

Except planar systems and / or CNG.

REPLACES / REEMPLAZA:

Original: 25.106.073, 93.232.414, **Delphi:** SOD00139

APPLICATION / APLICACIÓN:

GM: Astra 1.8 /2.0 (MPFI) 99>, Blazer, S10 2.2 (EFI - MPFI) 95>, Celta 1.0 (MPFI) 01>, Corsa 1.0 /1.4 /1.6 (EFI - MPFI) 94>, Ipanema, Kadett 2.0 (MPFI) 97>, Omega, Vectra 2.2 (MPFI) 96>, Zafira 2.0 8V 02>.

GM
G08170

FEATURES / CARACTERÍSTICAS: 01 wire, Length 40cm

Except systems CNG.

REPLACES / REEMPLAZA:

Bosch: 0 258 986 501; **GM:** 93.322.207

APPLICATION / APLICACIÓN:

GM: Celta 1.0 (MPFI) 08/00>12/02, Celta 1.0 VHC 10/02>03/06, Celta 1.4 (MPFI) 08/03>12/06, Corsa, Sedan 1.0 VHC 02/02>08/05, Corsa/ Sedan 1.8 (MPFI) 02/02>, Meriva 1.8 8V (MPFI) 08/02, Meriva 1.8 16V (SFI) 08/02>12/03;

GM
G08370

FEATURES / CARACTERÍSTICAS: 03 wires, Length 91cm.

Except systems CNG.

REPLACES / REEMPLAZA:

Bosch: 0 258 003 017; **Original:** 25.133.503; **GM:** 90.010.999, 90.448.458; **MTE:** 7816.30.037, 7816.30.091, 7816.30.122, 7816.30.7773; **Siemens/VDO:** D33003

APPLICATION / APLICACIÓN:

FIAT: Elba, Prêmio, Uno 1.5 ie 8V (SPI) 92>96;

GM: Astra 2.0 (MPFI) 94>95, Blazer, S10 4.3 V6 90>95, C20, Silverado 4.1, Vectra CD 2.2 16V 96>, Omega 2.0 (MPFI) 94>, Omega, Suprema 3.0, 4.1 92>, Vectra CD 2.0 8V (MPFI) 93>96

GM
G08378

FEATURES / CARACTERÍSTICAS: 03 wires, Length 125 cm.

Except planar systems and / or CNG.

REPLACES / REEMPLAZA:

Original: 25.133.503; **Bosch:** 0.258.003.017, 90.010.999, 90.448.458

APPLICATION / APLICACIÓN:

GM: Astra 2.0 (MPFI) 94>95, C20, Silverado 4.1 96>, Omega 2.0 (MPI) 94>, Omega, Suprema 3.0 /4.1 92>, S10 4.3 V6 90>95, Vectra CD 2.0 8V 93>96, Vectra CD 2.2 16V 96>.

GM
G08436

FEATURES / CARACTERÍSTICAS: 04 wires, Length 45 cm.

Except planar systems and / or CNG.

REPLACES / REEMPLAZA:

Original: 25.312.200, 93.386.736; **Delphi:** SOD00138

APPLICATION / APLICACIÓN:

GM: Blazer, S10 4.3 V6 99>, Montana 1.8L 8V (MPFI) 04>.

PEUGEOT
G08428

FEATURES / CARACTERÍSTICAS: 04 wires, Length 68 cm.

Except planar systems and / or CNG.

REPLACES / REEMPLAZA:

Original: 1628.hn/hr

APPLICATION / APLICACIÓN:

PEUGEOT: 206 1.6 8/16v 99>.

TOYOTA / LEXUS
G08055

FEATURES / CARACTERÍSTICAS: 04 wires, Length 58 cm.

REPLACES / REEMPLAZA:

Walker: 250-24055, 250-24051 (37.5cm), 250-24056 (50.5cm)

APPLICATION / APLICACIÓN:

TOYOTA: Pickup 91-89 2.4 /91-90 2.4 /91-90 3.0 V6 /89 3.0 V6 V 3VZE, Tundra 88-89 2.2, Celica 89-88 2.0, Land Cruiser: 94-93 4.5 /89-

88 4.0, MR2 89-88 1.6, Camry 91-90 2.5 V6 /89-88, 4Runner 91-90 2.4 /91-90 3.0 V6;

LEXUS: ES250 91-90 2.5 V6 /91-88 2.5 V6 /89-88 2.5 V6;

VW
G08405

FEATURES / CARACTERÍSTICAS: 04 wires, Length 100 cm.

Except planar systems and / or CNG.

REPLACES / REEMPLAZA:

Original: 048.906.265.1, 6KE.906.265A, 6KE.906.265B, 377.906.265A, 377.906.265B, 377.906.265E

APPLICATION / APLICACIÓN:

AUDI: a3 99>;

VW: Gol 1.0 /1.8L 02>05, Gol, Parati, Saveiro 1.6 /1.8 /2.0 AP (EFI) 96>02, Gol, Parati 1.0 8/16V AT (EFI) 96>02, Gol, Parati 1.0 16V Turbo AT (EFI) 00>04, Gol, Parati 2.0 16V AP (EFI) 95>00, Gol, Saveiro (Geração IV) 1.6 /1.8 05, Polo Classic 1.0L 16V (EFI) 01>03, Polo Classic 1.6L, 1.8L (EFI) 96>03, Quantum, Santana 1.8L, 2.0L AP (EFI) 96>01, Van 1.6L (EFI) 98>03.

VW
G08416

FEATURES / CARACTERÍSTICAS: 04 wires, Length 115 cm.

Except planar systems and / or CNG.

REPLACES / REEMPLAZA:

Original: 06A.906.262AS, 06A.906.262BP, 06A.906.262C, 06A.906.262F, 06A.906.262Q, 06A.906.265F, 021.906.262C, 036.906.262D, 5X3.906.262

APPLICATION / APLICACIÓN:

VW: Gol, Parati MI AT, 8/16V (EFI) 01>02, Gol 1.0 8/16V, 1.6L /1.8L (todos MPI) 02>05, Gol 1.0 /1.6 /1.8 8V (MPI) 05>, Gol III 1.0L 03, Gol IV 1.0 MI AT 05, Golf A4 1.6 01>02, Golf A4 1.8 20V Turbo 99>04, Golf A4 2.0L 02, Golf A4 2.0 8V 99>02, Golf A4 2.0 8V (pré-catalisador) 01>02, Golf A4 1.8 20V Turbo, 2.8L 24V (pós-catalisador) 02>03, Parati, Saveiro 1.6L /1.8L 02>, Polo /Sedan 1.4L 16V (pós-catalisador) 02, Polo 1.6 /2.0 02.

VW
G08462

FEATURES / CARACTERÍSTICAS: 04 wires, Length 163 cm.

Except planar systems and / or CNG.

REPLACES / REEMPLAZA:

Original: 06A.906.262.AK

APPLICATION / APLICACIÓN:

VW: Golf A4 1.6 8V 99>01.



EMS COMPONENTS | SISTEMA DE CONTROL DE MOTOR

OXÍGENO PLANAR SENSOR | SENSOR DE OXÍGENO PLANAR

UNIVERSAL

G09430



FEATURES / CARACTERÍSTICAS: 04 wires, Lenght 100 cm

Except CNG

FEATURES / CARACTERÍSTICAS:

Bosch: 0 258 006 376, 0 258 006 827, 0 258 986 507

APPLICATION / APLICACIÓN:

Universal planar

BOSCH

G09441



FEATURES / CARACTERÍSTICAS: 04 wires, Lenght 46 cm

Except CNG

FEATURES / CARACTERÍSTICAS:

93338741

APPLICATION / APLICACIÓN:

CHEVROLET: Celta 1.0 1.0L MPFI 8V 06/, Corsa 1.0 8V VHC 06/, Classic 1.0 8V - E 09/10, Meriva 1.4 MPFI 8V Econoflex 06/, Montana 1.4 MPFI 8V Econoflex 06/, Prisma 1.4 MPFI 8V Econoflex 02/

BOSCH

G09460



FEATURES / CARACTERÍSTICAS: 04 wires, Lenght 45 cm

Except CNG

FEATURES / CARACTERÍSTICAS:

Bosch: 0 258 006 251, 0 258 006 460; **VW:** 06A.906.262.BP

APPLICATION / APLICACIÓN:

VOLKSWAGEN: Gol GIII 1.0L 03, Gol IV 1.0 Total Flex 05, Golf IV 2.0L 02, Kombi 1.4 Flex 06/, Polo 2.0 Flex 02/06, ;

BOSCH

G09414



FEATURES / CARACTERÍSTICAS: 04 wires, Lenght 40 cm

Except CNG

FEATURES / CARACTERÍSTICAS:

Bosch: 0 258 006 016, 0 258 006 022; **Fiat:** 1010006, 1108795; **Ford:** 96VB-9F472-CA, 96VB-9F472-DA, 96VB-9F472-DB

APPLICATION / APLICACIÓN:

FORD: Courier 1.4L Zetec-SE 1.6V 97/99, Fiesta 1.4 16V 97/99, 1.4L Zetec-SE 1.6V 96/99,

BOSCH

G09437



FEATURES / CARACTERÍSTICAS: 04 wires, Lenght 43 cm

Except CNG

FEATURES / CARACTERÍSTICAS:

Bosch: 0 258 010 131; **Fiat:** 46762182, 60816794

APPLICATION / APLICACIÓN:

ALFA ROMEO: 147 2.0 16V 00/, 156 2.5 24V, 2.0 16V 02/05;

FIAT: 1.0, 1.3 16V MPI 00/03, Siena 1.0, 1.3 16V MPI 00/03;

GM: Blazer 2.4 MPFI 07/, Corsa 1.0 VHC 05/08, S10 2.4 MPFI 07/, Vectra 2.0 Flexpower 09/10, Zafira 2.0 Flexpower 08/



EMS COMPONENTS | SISTEMA DE CONTROL DE MOTOR

TBI | TBI

CITROËN
GI7001

REPLACES / REEMPLAZA:
Citroën: 9640796280, 1635.R8

Vdo: 408239821001Z

Fiat: 9640796280

APPLICATION / APLICACIÓN:
CITROËN: Berlingo Multispace MPV MK1 1.4i 1996>2008, Berlingo Van MK1 1.4i 1996>2011, C2 1.4 2003;

FIAT: Fiorino Van 2007;

PEUGEOT: 207 hatch 1.4 2006, 207 SW estate 1.4 2007, Bipper Van 1.4 2008, Partner MK1 MPV 1.4 1996>2015, Partner MK1 Van 1.4 1996>2015, 1007 1.4 2005

VW
GI7002

REPLACES / REEMPLAZA:
VW: 030 133 062F, 445MV5

APPLICATION / APLICACIÓN:
VW: Gol, Fox, Voyage 1.0 2011>, Kombi 2009 Flex

VW
GI7003

REPLACES / REEMPLAZA:
VW: 036 133 062R, 036 1 33 062K;

VDO: 408 238 371 R003

APPLICATION / APLICACIÓN:
VW: Gol 1.0 16V 2001>2004, Parati 1.0 16V 2001>2005, Fox 1.0 16V 2002>

VW
GI7004

REPLACES / REEMPLAZA:
VW: 030 133 062D;

VDO: 408 238 371 R004

APPLICATION / APLICACIÓN:
VW: Bora Saloon 2.0 1998>2005 / 2.0 4motion, Bora Estate 2.0 4motion, Golf MK4 hatch 2.0 1998>2004, 2.0 4motion 2000>2005, Golf MK4 estate 2.0 1999>2006 / 2.0 4motion 2000>2006 / 2.0 bi-fuel 2002>2006, New Beetle 2.0 1998>2010, New Beetle convertible 2.0 2002>2010;

SEAT: Cordoba MK2 Saloon 2.0 2002>2009, Ibiza MK4 Saloon 2.0 2002>2009;

SKODA: Fabia MK1 hatch 2.0 1999>2008, Fabia MK1 Saloon 2.0 1999>2007, Fabia MK1 Estate 2.0 2000>2007, Octavia MK1 hatch 2.0 1999>2007, Octavia MK1 Estate 2.0 1999>2007 / 2.0 4x4 2000>2004

VW
GI7005

REPLACES / REEMPLAZA:
VW: 036 133 064P;

VDO: 408 237 730 R005

APPLICATION / APLICACIÓN:
VW: Gol, Polo Classic 1.0 mi 2001>2003

VW
GI7006

REPLACES / REEMPLAZA:
VW: 030 133 064H;

VDO: 408 237 730 R003

APPLICATION / APLICACIÓN:
VW: Gol GL 1.0 8V 1994>2006, Gol Special 1.0 8V 2003>2005, Parati 1.0 8V 1996>2000

VW
GI7007

REPLACES / REEMPLAZA:
VW: 036 133 064K;

VDO: 408 237 730 R004

APPLICATION / APLICACIÓN:
VW: Gol GL 1.0 16V 1994>2002, Parati 1.0 16V 1996>2002

VW
GI7008

REPLACES / REEMPLAZA:
VW: 036 133 064Q;

VDO: 408 237 730 R008

APPLICATION / APLICACIÓN:
VW: Gol Power 1.0 16V 1994>2002, Parati Power 1.0 16V 1996>2002

BOSCH
GI7009

REPLACES / REEMPLAZA:
VW/ Audi/ Seat/ Skoda: 06B133062M;

Bosch: 0 280 750 009

APPLICATION / APLICACIÓN:
AUDI: A4 Mk2 Saloon 1.8T 2000>2004, A4 Mk2 Avant/Estate 1.8T 2001>2004, A4 Convertible 1.8T 2002>2009, A4 Mk3 Saloon 1.8T 2004>2008, A4 Mk3 Avant/Estate 1.8T 2004>2008, A6 Mk2 Saloon 1.8T 1997>2005, A6 Mk2 Avant/Estate 1.8T 1997>2005

SEAT: Exeo 1.8T 2008>2010, Exeo ST 1.8T 2009>2010

SKODA: SuperB Mk1 Saloon 1.8T 2001>2008

VW: Passat Mk5 Saloon/Estate 1.8T 1996>2000, Passat Mk5 Saloon/Estate 1.8T 20v 2000>2005

VW
GI7010

REPLACES / REEMPLAZA:
VW: 030 133 064G/D;

VDO: 408 237 730 R002

APPLICATION / APLICACIÓN:
VW: Gol 1.0 8V 1994>2002, Gol special 1.0 8V 2003>2005, Parati 1.0 8V 1996>2002

VW
GI7011

REPLACES / REEMPLAZA:
VW/ Audi: 058133063H

Vdo: 408 237 212 002Z

APPLICATION / APLICACIÓN:
AUDI: A4 Mk1 saloon 1.6/1.8/1.8 quattro 1994>2000, A4 Mk1 Avant/estate 1.6/1.8/1.8 quattro 1994>2001, A6 Mk2 saloon 1.8 1997>2005, A6 Mk2 Avant/Estate 1.8 1997>2005

VW: Passat Mk5 saloon 1.6/1.8/1.8 Syncro/4motion, Passat Mk5 estate 1.6/1.8/1.8 Syncro/4 motion

VW
GI7012

REPLACES / REEMPLAZA:
Vw/Audi/Seat/Skoda: 06A 133 064 J;

Vdo: 408237111012Z

APPLICATION / APLICACIÓN:
AUDI: A3 Mk1 hatch 1.6/1.8 1996>2003

SEAT: Cordoba Mk1 hatch/estate 1.6 1999>2002, Ibiza Mk3 hatch 1.6 1999>2002, Leon Mk1 hatch 1.6 1999>2006, Toledo Mk2 Saloon 1.6 1998>2004

SKODA: Octavia Mk1 hatch 1.6 1997>2007 / 1.8 1996>2000, Octavia Mk1 estate 1.6 1998>2007 / 1.8 20v 1998>2000

VW: Bora Saloon 1.6 1998>2005, Bora Estate 1.6 1999>2005, Golf Mk4 hatch 1.6 1997>2004, Golf Mk4 estate 1.6 1999>2002, Polo classic Mk3 Saloon 100 1.6 1995>2001, Polo Mk3 estate 1.6 1997>2001

VW
GI7013

REPLACES / REEMPLAZA:
VW/Seat: 037133064;

Vdo: 408237111002Z

APPLICATION / APLICACIÓN:
SEAT: Cordoba Mk1 Saloon 2.0i 1993>1999, Ibiza Mk2 hatch 2.0i 1993>1999, Toledo Mk1 hatch 2.0i 1991>1999

VW: Corrado 2.0i 1993>1995, Golf Mk3 hatch 2.0 1991>1997, Golf Mk3 estate 2.0 1993>1999, Golf Mk3 cabriolet 2.0 1993>1998, Passat Mk3/4 Saloon 2.0 1990>1996, Passat Mk3/4 estate 2.0 1990>1997, Vento 2.0 1991>1998

VW
GI7014

REPLACES / REEMPLAZA:
VW: 06A 133 063G;

VDO: 40B 237 212 007Z

APPLICATION / APLICACIÓN:
VW: Bora Saloon 1.8T 2000>2005, Bora Estate 1.8T 2000>2005, Golf MK4 Estate 1.8T 2000>2006, Golf MK4 hatch 1.8T 1997>2005;

AUDI: A3 MK1 hatch 1.8T 1996>2003;

SKODA: Octavia MK1 hatch 1.8T 1997>2010

VW
GI7015

REPLACES / REEMPLAZA:

VW/ Audi/ Seat/ Skoda: 06A133064M;

Vdo: 408237111015Z

APPLICATION / APLICACIÓN:

AUDI: A3 Mk1 hatch 1.8 1996>2003

SEAT: Leon Mk1 hatch 1.8 20v 1999>2006, Toledo Mk2 Saloon 1.8 20v 1998>2004

SKODA: Octavia Mk1 hatch 1.8 1996>2000

VW: Bora Saloon 1.8 1998>2005, Bora Estate 1.8 1999>2005, Golf Mk4 hatch 1.8 1997>2005, Golf Mk4 estate 1.8 1999>2006

VW
GI7016

REPLACES / REEMPLAZA:

VW/ Seat: 06A133064P;

Vdo: 408237111016Z

APPLICATION / APLICACIÓN:

SEAT: Alhambra MPV 1.8T 20v 1997>2010

VW: Sharan 1.8T 20v 1997>2010

VW
GI7017

REPLACES / REEMPLAZA:

VW/ Skoda: 06A133064H;

Vdo: 408237111017Z

APPLICATION / APLICACIÓN:

SKODA: Octavia Mk1 hatch 2.0 1999>2007

VW: Bora Saloon/Estate 2.0 1998>2005, Golf Mk4 2.0 1998>2004, Golf Mk4 Estate 2.0 1999>2006, New Beetle 2.0 1998>2010

VW
GI7018

REPLACES / REEMPLAZA:

VW: 036 133 064D;

Vdo: 408 237 130 003Z

APPLICATION / APLICACIÓN:

VW: Lupo hatch 1.4 16v 1998>2005, Polo Mk3F hatch 1.4 16v 1999>20001

VW
GI7019

REPLACES / REEMPLAZA:

VW/Seat/Skoda: 030133064F;

Vdo: 408 237 130 004Z

APPLICATION / APLICACIÓN:

SEAT: Arosa hatch 1.0/1.4 1997>2004, Cordoba Mk1 saloon 1.0i/1.4i/1.6i 1993>1999, Cordoba Mk1 estate/hatch 1.4i/1.6i 1996>1999, Ibiza Mk2 hatch 1.0i/1.4i/1.6i 1993>1999, Ibiza Mk3 hatch 1.6 1999>2002, Leon Mk1 hatch 1.4 16v 1999>2006, Toledo Mk2 saloon 1.4 16v 2000>2002

SKODA: Octavia Mk1 hatch 1.6 1996>2004, Octavia Mk1 estate 1.6 1998>2004

VW: Bora Saloon/estate 1.4 16v 2000>2005, Golf Mk4 hatch/estate 1.4 16v 1997>2005, Lupo hatch 1.0 1998>2005, Polo Mk3 hatch 50 1.0 / 55 1.4 / 60 1.4 / 75 1.6, Polo Mk3 van 1.4 1998>1999, Polo classic Mk3 saloon 60 1.4 / 75 1.6 1995>2001, Polo Mk3 estate 1.4/1.6 1997>2001

NISSAN
GI7020

REPLACES / REEMPLAZA:

Nissan: S20052, 16119AU000, 16119AU003, 16119AU00A, 16119AU00B, 16119AU00C

APPLICATION / APLICACIÓN:

NISSAN: Almera Mk2 Hatch/Saloon 1.8 2000>, Almera Tino MPV 1.8 2000>2006, Primera Mk3 Hatch/Estate 1.6/1.8 2002>

JEEP
GI7021

REPLACES / REEMPLAZA:

Jeep: 04891735AC

APPLICATION / APLICACIÓN:

DODGE: Journey 2.4 2009>2016, Avenger 2.4 2008>2014, Caliber 1.8/2.0/2.4 2007>2012

JEEP: Compass 2.0/2.4 2007>2016, Patriot 2.0/2.4 2007>2016

CHRYSLER: 200 2.4 2011>2015

VW
GI7022

REPLACES / REEMPLAZA:
VW/Seat: 047133061G;
Vdo: 408 237 430 003Z
APPLICATION / APLICACIÓN:
VW: Lupo hatch 1.0 1998>2005
SEAT: Arosa hatch 1.0 1997>2004

VW
GI7023

REPLACES / REEMPLAZA:
VW: 037133064J;
Vdo: 408237111018Z
APPLICATION / APLICACIÓN:
VW: Golf Mk4 Cabriolet 2.0 1998>2002

NISSAN
GI7024

REPLACES / REEMPLAZA:
Nissan: AC57-001
APPLICATION / APLICACIÓN:
NISSAN: Z24 2.4

VW
GI7025

REPLACES / REEMPLAZA:
VW/Seat: 037133064D;
Vdo: 4082371110067
APPLICATION / APLICACIÓN:
SEAT: Cordoba Mk1 Saloon/Estate 1.6i 1996>1999, Ibiza Mk2 hatch 1.6i 1996>1999, Toledo Mk1 hatch 1.6i 1996>1999
VW: Golf Mk3 hatch 1.6 1995>1997, Golf Mk3 Estate 1.6 1994>1999, Golf Mk4 cabriolet 1.6 1998>2002, Passat Mk3/4 Saloon 1.6 1994>1996, Passat Mk3/4 Estate 1.6 1994>1995, Polo classic Mk3 Saloon 100 1.6 1995>2001, Polo Mk3 Estate 1.6 1997>2001, Vento 1.6 1994>1998

AUDI
GI7026

REPLACES / REEMPLAZA:
Audi: 058133063B;
Vdo: 408237210002Z
APPLICATION / APLICACIÓN:
AUDI: A4 Mk1 Saloon 1.6/1.8 1994>2000, A4 Mk1 Avant/Estate 1.6 1994>2001 / 1.8 1996>2001

AUDI
GI7027

REPLACES / REEMPLAZA:
Audi: 058133063;
Vdo: 408 237 210 001Z
APPLICATION / APLICACIÓN:
AUDI: A4 Mk1 Saloon 1.6/1.8 1994>2000 / 1.8 quattro 1995>2000, A4 Mk1 Avant/Estate 1.6 1994>2001 / 1.8 1996>2001 / 1.8 quattro 1996>2001

VW
GI7028

REPLACES / REEMPLAZA:
VW: 037133064B, 037133064F;
Vdo: 408237111004Z
APPLICATION / APLICACIÓN:
VW: Cabrio GL/GLS convertible 2.0L 1998>1999, Cabrio High line convertible 2.0 1997, Jetta III 1993>1999, Golf III 1996>2003

VW
GI7029

REPLACES / REEMPLAZA:

VW/Seat: 037133064K;

Vdo: 408237111019Z

APPLICATION / APLICACIÓN:

SEAT: Cordoba Mk1 Saloon/Estate 1.6i 1996>1999, Ibiza Mk2 hatch 1.6i 1996>1999

VW: Polo classic Mk3 Saloon 100 1.6 1995>2001, Polo Mk3 Estate 1.6 1997>2001

AUDI
GI7030

REPLACES / REEMPLAZA:

Audi: 058133063F;

Vdo: 408 237 210 004Z

APPLICATION / APLICACIÓN:

AUDI: A4 Mk1 Saloon 1.8T/1.8T quattro 1995>2000

VW
GI7031

REPLACES / REEMPLAZA:

VW: 06A133064Q;

Vdo: 408237111023Z

APPLICATION / APLICACIÓN:

VW: Golf Mk3 hatch 1.8 1991>1997 / 2.0 GTI 16v 1992>1997

VW
GI7032

REPLACES / REEMPLAZA:

VW/Seat: 06A133064A

APPLICATION / APLICACIÓN:

VW: Sharan 2.0 1995>2010

SEAT: Alhambra MPV 2.0i 1996>2010

VW
GI7033

REPLACES / REEMPLAZA:

VW/Seat: 037133064A;

Vdo: 408237111003Z

APPLICATION / APLICACIÓN:

VW: Sharan 2.0 1995>2010

SEAT: Alhambra MPV 2.0i 1996>2010

VW
GI7035

REPLACES / REEMPLAZA:

VW: 06A133064B;

Vdo: 408237111005Z

APPLICATION / APLICACIÓN:

VW: Transporter T4 minibus/van/flatbed 2.5/2.5 Syncro 1990>2003

BOSCH
GI7036

REPLACES / REEMPLAZA:

VW/Seat/Skoda/Audi: 06A133062BD

Bosch: 0 280 750 036

APPLICATION / APLICACIÓN:

AUDI: A3 Mk1 hatch 1.8T/1.8T quattro/S3 quattro 1996>2003, TT coupe Mk1 1.8T/1.8T quattro 2002>2006, TT roadster cabrio Mk1 1.8T/1.8T quattro 1999>2006

SEAT: Cordoba Mk1 hatch 1.8T 20v cupra, Ibiza Mk3 hatch 1.8T 20v cupra, Leon Mk1 hatch 1.8 20v T/1.8T cupra, Toledo Mk2 Saloon 1.8 20v T

SKODA: Octavia Mk1 hatch 1.8T 1997>2006, Octavia Mk1 estate 1.8T 1998>2010

VW: Bora Saloon/estate 1.8T 2000>2005, Golf Mk4 hatch/estate 1.8 T/1.8T GTI 1997>2005, New Beetle 1.8T 1999>2010

GM
GI7037

REPLACES / REEMPLAZA:
GM: 520037
 APPLICATION / APLICACIÓN:
CHEVROLET: Aveo 1.6 L4

VW
GI7038

REPLACES / REEMPLAZA:
VW/Seat: 036133064C;
Vdo: 408 237 111 001Z
 APPLICATION / APLICACIÓN:
VW: Polo Mk3 hatch 100 1.4 16v 1996>1999
SEAT: Cordoba Mk1 Saloon 1.4i 16v 1996>1999, Ibiza Mk2 hatch 1.4i 416v 1997>1999

VW
GI7039

REPLACES / REEMPLAZA:
VW/Seat: 036133064E;
Vdo: 408237111011Z
 APPLICATION / APLICACIÓN:
VW: Lupo hatch 1.4 16v 1999>2005, Polo Mk3 hatch 100 1.4 16v 1996>1999/120 1.6 16v GTI 1998>1999, Polo Mk3F hatch 1.4 16v 1999>2001
SEAT: Arosa hatch 1.4 16v 2000>2004, Cordoba Mk1 Saloon 1.4i 16v 1996>1999

DELPHI
GI7040

REPLACES / REEMPLAZA:
Delphi: TB10040;
GM: 93397828
 APPLICATION / APLICACIÓN:
CHEVROLET: Corsa hatch 1.4/1.8 8v 2006>2010, Corsa sedan 1.8 8V2006>2010, Meriva 1.8 8V 2006>2010, Montana 1.4/1.8 8V 2006>2010;
FIAT: Doblo, Idea, Palio, Palio Weekend, Punto, Siena, Stilo, Strada all with engine 1.8 8V 2006>2010

JEEP
GI7041

REPLACES / REEMPLAZA:
Jeep: 04591847AC, 520041;
Vdo: A2C53099252
 APPLICATION / APLICACIÓN:
DODGE: Ram 1500 5.7 2006, Dodge Charger 5.7 Hemi 2006
JEEP: Cherokee 5.7 hemi 2010

DELPHI
GI7042

REPLACES / REEMPLAZA:
Delphi: TB10043;
GM: 7087939, 98500110, 93397800
 APPLICATION / APLICACIÓN:
GM: Corsa 1.4/1.8 2006>2012, Meriva 1.8 2006>2012, Montana 1.4/1.8 2006>2012

VW
GI7043

REPLACES / REEMPLAZA:
VW/Audi/Seat/Skoda: 03G128063A, 03G128063G, 03G128063M, 03G128063Q;
Vdo: A2C59511699
 APPLICATION / APLICACIÓN:
AUDI: A3 Mk2 hatch 2.0 2005>2008
SEAT: Cordoba Mk2 Saloon 1.4 2005>2009, Ibiza Mk4 hatch 1.4 2005>2009, Leon Mk2 hatch 1.9/2.0 2005>2010
SKODA: Octavia Mk2 hatch/estate 2.0 2005>2010, Roomster 1.4/1.9 2006>2010
VW: Eos convertible 2.0 2006>2008, Golf Mk5 hatch/plus 2.0 2004>2008, Jetta Mk3 Saloon 1.9/2.0 2005>2010, Passat Mk6 estate 1.9/2.0 2005>2009, Transporter T5 minibus 1.9 2006>2009

DELPHI
GI7044

REPLACES / REEMPLAZA:

Delphi: TB10044;

GM: 24579416, 2457694

APPLICATION / APLICACIÓN:

CHEVROLET: Corsa Classic, Prisma, Celta all with engine 1.0 8V 2009>2012

VW
GI7045

REPLACES / REEMPLAZA:

Vdo: 400238321003Z, 4002383210072;

VW/Seat/Skoda: 036133062B, 036133062N

APPLICATION / APLICACIÓN:

SEAT: Alhambra Mpv 2.0i 1996>2010, Cordoba Mk1 hatch 1.4 16v 2000>2002, Ibiza Mk3 hatch 1.4 16v 2000>2002

SKODA: Fabia Mk1 hatch 1.2 2002>2008

VW: Sharan 2.0 1995>2010 / 2.0 LPG 2006>2010

VW
GI7046

REPLACES / REEMPLAZA:

Vdo: 408 238 321 006Z;

VW/Audi/Skoda/Seat: 036 133 062L

APPLICATION / APLICACIÓN:

AUDI: A2 hatch 1.4 2000>2005

SEAT: Cordoba Mk1 hatch/estate 1.4 16v 1999>2002, Cordoba Mk2 Saloon 1.2/1.4 2002>2007, Ibiza Mk3 hatch 1.4 16v 2000>2002, Ibiza Mk4 hatch 1.2/

1.4 2002>2007, Inca Van 1.4 16v 2000>2003, Leon Mk1 hatch 1.4 16v 1999>2006, Toledo Mk2 Saloon 1.4 16v 2000>2002

SKODA: Fabia Mk1 hatch/saloon/estate/van 1.2 2002>2008, Octavia Mk1 hatch/estate 1.4 16v 2000>2010, Octavia Mk2 hatch 1.4 2004>2006

VW: Bora Sallion/estate 1.4 16v 2000>2005, Caddy Mk2 Estate/van 1.4 16v 2000>2004, Golf Mk4 hatch/estate 1.4 16v 1997>2005, Golf Mk5 hatch/plus 1.4 16v

2003>2006, Lupo hatch 1.4 16v 1998>2005, New Beetle 1.4 16v 1998>2005, Polo classic Mk3 Saloon 1.4 16v 1999>2001, Polo Mk3 Estate/ hatch 1.4 16v 1999>2001,

Polo Mk4 hatch/saloon 1.2 2002>2008

VW
GI7047

REPLACES / REEMPLAZA:

Vdo: 408 238 321 004Z;

VW: 0471 33 062D

APPLICATION / APLICACIÓN:

SKODA: Fabia Mk1 hatch/saloon/estate/van 1.0/1.4 1999>2003, Octavia Mk1 hatch 1.4 1999>2001

BOSCH
GI7048

REPLACES / REEMPLAZA:

Fiat: 55187316;

Bosch: 0 280 750 137;

VW: 0471 33 062D

APPLICATION / APLICACIÓN:

ALFA ROMEO: Mito 1.4 Tjet 2008->

FIAT: Bravo Mk2 1.4 2007->, Doblo Kombi 1.4 2010->, Idea 1.4 2003->, Linea 1.4 Tjet, Punto Mk2 hatch 1.4 2003>2012, Grande Punto 1.4 16v 2005->, Punto Evo 1.4 16v 2009>2012, Stilo hatch/estate 1.4 16v 2004>2006, 500L 1.4 2013->

LANCIA: Delta Mk3 hatch 1.4 2008>2014, Musa 1.4 2004>2012, Ypsilon 1.4 16v 2003>2011

VW
GI7049

REPLACES / REEMPLAZA:

Vw/Seat/Skoda/Audi: 06A133062AT, A2C53093430

Vdo: 408238323014Z

APPLICATION / APLICACIÓN:

AUDI: A3 Mk2 hatch 1.6 2003>2012 / 1.6 E-Power 2011>2012, A3 convertible 1.6 2008>2010

SEAT: Altea MPV 1.6 2004-> / 1.6 LPG 2009->, Altea XL MPV 1.6 multifuel 2006-> / 1.6 LPG 2009->, Leon Mk2 hatch 1.6 2005>2012 / 1.6 LPG 2009>2012, Toledo Mk3 MPV 1.6 2004>2009

SKODA: Octavia Mk2 hatch/estate 1.6 2004>2013 / 1.6 LPG 2009>2012 / 1.6 Multifuel 2008>2013

VW: Caddy III estate 1.6 2004>2015 / 1.6 BiFuel 2011>2015, Caddy Mk3 van 1.6 2004>2015 / 1.6 BiFuel 2011>2015, Golf Mk5 hatch/estate 1.6 2004>2008, Golf VI 1.6 2008>2012 / 1.6 BiFuel 2009>2012 / 1.6 MultiFuel 2008>2012, Golf VI variant 1.6 2009>2013, Golf Mk5 plus 1.6 2005>2013 / 1.6 BiFuel 2009>2013 / 1.6 MultiFuel 2007>2013, Jetta Mk3 Saloon 1.6 2005>2010 / 1.6 MultiFuel 2008>2010, Passat Mk6 Saloon/Estate 1.6 2005>2010, Touran 1.6 2003>2010

FORD
GI7050

REPLACES / REEMPLAZA:
Ford: 3L5E-AE, 3L5E-AD, 9W7E-BA, 6R3E, 3L5U

APPLICATION / APLICACIÓN:
FORD: Crown Victoria 4.6 2008, E-150 2005>2014, E-250 2005>2014, E-350 Super Duty 2005>2016, Explorer 2004>2010, F-150 2004>2006

LINCOLN: Town Car Executive L Limousine 4-Door 4.6 2008

FORD
GI7051

REPLACES / REEMPLAZA:
Ford: AT4Z-9E26A/B, AT4E-ED

APPLICATION / APLICACIÓN:
FORD: Edge 3.5 2015, Explorer 3.5 2015, F-150 3.5 2015, Mustang 3.7 2015, Taurus 3.5 2015

FORD
GI7052

REPLACES / REEMPLAZA:
Ford: 8L3E9F991CB, 3L3E9F991AA

APPLICATION / APLICACIÓN:
FORD: Expedition 5.4 2014, F-150 2010

LINCOLN: Navigator Base Sport 2014

NISSAN
GI7053

REPLACES / REEMPLAZA:
Nissan: 16119-AE013, 16119-AE01B, 16119-AE01C

APPLICATION / APLICACIÓN:
NISSAN: Altima 2006 Base Sedan, X-trail 2.5 4x4 2002>2013

VW
GI7054

REPLACES / REEMPLAZA:
Vw/Audi/Skoda: 06B133062L;

Vdo: 408238323006Z

APPLICATION / APLICACIÓN:
AUDI: A4 Mk1 Saloon 1.6 1994>2000, A4 Mk1 Avant/Estate 1.6 1994>2001

SKODA: SuperB Mk1 Saloon 2.0 2001>2008

VW: Passat Mk5 Saloon/Estate 1.6 1996>2000 / 2.0 2000>2005 / 2.0 4motion 2000>2005

FORD
GI7055

REPLACES / REEMPLAZA:
Standart: S20022

APPLICATION / APLICACIÓN:
FORD: Explorer 4.6, Explorer Sport Trac 4.6

MERCURY: Mountaineer 4.6

VW
GI7056

REPLACES / REEMPLAZA:
Vdo: 408238223003Z;

Vw/Audi/Seat: 06B133062P

APPLICATION / APLICACIÓN:
AUDI: A4 Mk1 Saloon 1.6 2000, A4 Mk1 Avant/Estate 1.6 2000>2001, A4 Mk2 Saloon 1.6 2000>2004, A4 Mk2 Avant/Estate 1.6 2001>2004, A4 Mk3 Saloon 1.6 2004>2008, A4 Mk3 Avant/Estate 1.6 2004>2008

SEAT: Exeo 1.6 2009>2010, Exeo ST 1.6 2009>2010

VW: Passat Mk5 Saloon 1.6 2000>2005, Passat Mk5 Estate 1.6 2000>2005

VW
GI7057

REPLACES / REEMPLAZA:
Vw/Audi/Seat/Skoda: 06A133062AB, 06A133062N;

Vdo: 408 238 323 011Z

APPLICATION / APLICACIÓN:
AUDI: A3 Mk1 hatch 1.6 1996>2003 / 1.6 2000>2003, A3 Mk2 hatch 3 1.6 2003>2012, A3 Mk2 hatch 5 1.6 2004>2013

SEAT: Altea MPV 1.6 2004->, Cordoba Mk1 hatch/estate 1.6 1999>2002, Ibiza Mk3 hatch 1.6 1999>2002, Leon Mk1 hatch 1.6 1999>2006 / 2005>2006, Toledo Mk2 Saloon 1.6 1998>2004, Toledo Mk3 MPV 1.6 2004>2009

SKODA: Octavia Mk1 hatch/estate 1.6 2000>2010, Octavia Mk2 hatch/estate 1.6 2004>2013

VW: Bora Saloon/Estate 1.6 1998>2005, Caddy III estate 1.6 2004>2015, Caddy Mk3 van 1.6 2004>2015, Golf Mk4 hatch/estate 1.6 1997>2005, Golf Mk5 hatch 1.6 2004>2008, New Beetle 1.6 1999>2000 / 1.6 2000>2010, New Beetle convertible 1.6 2003>2010, Polo classic Mk3 Saloon 100 1.6 1995>2001, Polo Mk3 Estate 1.6 1997>2001, Touran 1.6 2003>2010

NISSAN
GI7058

REPLACES / REEMPLAZA:
Nissan: 670001, S200058, ETB0013, 16119-8J10C, 16119-8J103

APPLICATION / APLICACIÓN:
NISSAN: 350Z Coupe 3.5 2002->, 350Z Roadster Cabrio 3.5 2005->, Murano 3.5 4x4 2003>2008, Murano II 3.5 4x4 2008>2014

INFINITI: FX 35 All-wheel Drive 2003>2008

GM
GI7059

REPLACES / REEMPLAZA:
GM/Opel: 55560398, 93190367

APPLICATION / APLICACIÓN:
CHEVROLET: Cruze 1.6/1.8 2009->, Cruze hatchback 1.6/1.8 2011->

OPEL: Astra H hatch 1.6 2004>2014, Astra H GTC hatch 1.6 2005>2010, Astra H Saloon 1.6 2007>2014, Astra H estate 1.6 2004>2014 / 1.6 LPG 2009>2010, Astra H convertible 1.6 2005>2010, Zafira B MPV 1.6 2005>2008

BMW
GI7060

REPLACES / REEMPLAZA:
Vdo: 408238422003Z;

BMW: 13541439224

APPLICATION / APLICACIÓN:
BMW: 1 116i 2003>2011, 3 Series Saloon 316i 2002>2005, 3 Series Compact 316 ti 2001>2005, 3 Series Coupe 316Ci/318Ci 2000>2006, 3 Series Convertible 318Ci 2001>2007, 3 Series Estate 316i/318i 2001>2005, 3 Series Saloon 316i/318i 2004>2011, 3 Touring 318i 2006>2012

RENAULT
GI7061

REPLACES / REEMPLAZA:
Renault: 8200063652, 8200123061;

Vdo: 408 239 822 001Z

APPLICATION / APLICACIÓN:
RENAULT: Clio Mk2 hatch 1.6 16v 1998>, Kangoo Mk1 1.6 2001>, Kangoo Mk1 Van 1.6 16v 2001>, Laguna Mk2 hatch/estate 1.6/1.8 16v 2001>, Megane Mk1 hatch 1.6 16v 1999>2003, Megane Classic Saloon 1.6 16v 1999>2003, Megane Mk1 estate/coupe 1.6 16v 1999>2003, Megane convertible 1.6 16v 1999>2003, Scenic Mk1 1.6 16v 1998>1999

VW
GI7062

REPLACES / REEMPLAZA:
VW: 078133062B, 078133063A, 078133063AJ

APPLICATION / APLICACIÓN:
AUDI: A4 Mk1 Saloon/Avant/Estate 2.4/2.8 1996>2001, A4 Mk2 Saloon/Avant/Estate 2.4/3.0 2000>2004, A4 convertible 2.4/3.0 2002>2009, A4 Mk3 Saloon/Avant/Estate 3.0 quattro 2004>2006, A6 Mk2 Saloon/Avant/Estate 2.4/2.8/3.0 1997>2005, A6 Mk3 Saloon/Avant/Estate 3.0 2004>2006, A8 Mk1 Saloon 2.8 1996>2002, A8 Mk2 Saloon 3.0 2003>2006

SKODA: SuperB Mk1 Saloon 2.8 V6 2001>2008

VW: Passat Mk5 Saloon/Estate 2.8 V6 1996>2000

VW
GI7063

REPLACES / REEMPLAZA:
Vw/Audi: 058133063Q;

Vdo: 408 237 212 008Z

APPLICATION / APLICACIÓN:
AUDI: A4 Mk1 Saloon 1.8T/1.8T quattro 1995>2000, A4 Avant/Estate 1.8T/1.8T quattro 1996>2001, A6 Mk2 Saloon 1.8T/1.8T quattro 1997>2005, A6 Mk2 Avant/Estate 1.8T 1997>2005

VW: Passat Mk5 Saloon 1.8T 1996>2000, Passat Mk5 Estate 1.8T 1997>2000 **VW:** Passat Mk5 Saloon/Estate 2.8 V6 1996>2000

VW
GI7064

REPLACES / REEMPLAZA:
Vw/Seat/Skoda: 030 133 064D/G;

Vdo: 408 237 130 002 Z

APPLICATION / APLICACIÓN:
SEAT: Arosa hatch 1.0/1.4 1997>2004, Cordoba Mk1 saloon 1.0i/1.4i/1.6i 1993>1999, Cordoba Mk1 estate/hatch 1.4i/1.6i 1996>1999, Ibiza Mk2 hatch 1.0i/1.4i/1.6i 1993>1999, Ibiza Mk3 hatch 1.6 1999>2002, Inca Van 1.4i/1.6i 1995>2003

SKODA: Felicia Mk1 hatch/estate 1.6 LX 1995>1998, Felicia Fun Mk1 pickup 1.6 1997>2002, Felicia Mk2 hatch/estate 1.6 1998>2001

VW: Caddy Mk2 estate 1.4/1.6 1995>2004, Caddy Mk2 Van 60 1.4 1995>2004 / 75 1.6 1995>2000, Caddy Mk2 pickup 1.6 1996>2000, Golf Mk3 hatch 1.4/1.6 1991>1997, Golf Mk3 estate 1.4 1993>1999, Polo Mk3 hatch 50 1.0 / 55 1.4 / 60 1.4 / 75 1.6 1994>1999, Polo Mk3 van 1.4 1998>1999, Polo classic Mk3 Saloon 60 1.4 / 75 1.6 1995>2001, Polo Mk3 estate 1.4/1.6 1997>2001, Vento 1.4/1.6 1991>1998

BOSCH
GI7065

REPLACES / REEMPLAZA:
VW: 078133062;

Bosch: 0 280 750 003

APPLICATION / APLICACIÓN:
AUDI: A4 Mk2 Saloon/Avant/Estate S4 quattro 2003>2004, A4 convertible S4 quattro 2004>2009, A4 Mk3 Saloon/Avant/Estate S4 quattro 2004>2008, A5 coupe S5 quattro 2007>2012, A6 Mk2 Saloon/Avant/Estate 4.2 quattro 1998>2005, A6 Allroad Mk1 4.2 V8 quattro 2002>2005, A6 Mk3 Saloon/Avant/Estate 4.2 quattro 2004>2011, A6 Allroad Mk2 4.2 FSI quattro 2006>2010, A8 Mk1 Saloon 3.7 quattro 1998>2002, A8 Mk2 Saloon 3.7/4.2 2002>2010, Q7 4.2 FSI quattro 2006>2010

BOSCH
GI7072

REPLACES / REEMPLAZA:
Bosch: F 00H 600 072;

GM: 217-3110, S20015

APPLICATION / APLICACIÓN:
CHEVROLET: Buick, Pontiac, Saturn

BOSCH
GI7085

REPLACES / REEMPLAZA:
Citroën/Peugeot: 1635.Q9, 9635884080, 447280;

Bosch: 0 280 750 085

APPLICATION / APLICACIÓN:
CITROËN: Berlingo Multispace MK1 1.6 16V 2000>2011, Berlingo Van MK1 1.6 16V 2000>2008, C2 1.6 2003, C2 1.6 VTS 2005, C3 1.6 16V 2002, C3 Pluriel 1.6 2003, Xsara hatch 1.6 16V 2000>2005, Xsara Estate 1.6 16V 2000>2005, Xsara Coupe 1.6 16V 2000>2005;

PEUGEOT: 206 hatch 1.6 16V 2000, 206 Saloon 2007 1.6 16V 2007, SW estate 1.6 16V 2002, 1007 1.6 16V 2005, Partner MK1 1.6 16V

FIAT
GI7113

REPLACES / REEMPLAZA:
Fiat: 46737113, 40SMF1

APPLICATION / APLICACIÓN:
FIAT: Palio, Siena 1.0 16V 2001>2003

FIAT
GI7119 // NEW //

REPLACES / REEMPLAZA:
Nissan: 16119-ED000, 16119-ED00A, 16119-ED00B, 16119-ED00C

Meat & Doria: 89168

APPLICATION / APLICACIÓN:
NISSAN: Cube 1.6 16V 2010->, Micra Mk3 160 SR 2005>2010, Micra c+c convertible 1.6 160 SR, Note 1.6 2006>2012, Qashqai 1.6 2007>2013, Tiida saloon 1.6 2007>2012, Tiida hatchback 1.6 2007>2011

FIAT
GI7133 // NEW //

REPLACES / REEMPLAZA:

VDO: 408.238/373/003

VOLKSWAGEN: 032 133 062

APPLICATION / APLICACIÓN:

VOLKSWAGEN: Fox 1.6 2006>, Gol 1.6 2006>, Voyage 1.6 2009>, Cross Fox 1.6 2006>, Polo 1.6 2007>2015, Saveiro 1.6 2009>, Space Fox 1.6 2006>

VW
GI7134 // NEW //

REPLACES / REEMPLAZA:

VOLKSWAGEN: 032 133 062 B

VDO: A2C85080800

APPLICATION / APLICACIÓN:

VOLKSWAGEN: Gol 1.6 8/16V 2013>2016, Fox 1.6 8/16V 2010>, Voyage 1.6 8/16V 2013>2016, Space Fox 1.6 8/16V 2011>, Saveiro 1.6/1.8V 2014>2016, Golf 1.6 8/16V 2016>

VW
GI7135 // NEW //

REPLACES / REEMPLAZA:

VOLKSWAGEN: 032 133 062 C

VDO: A2C85097300

APPLICATION / APLICACIÓN:

VOLKSWAGEN: Gol 1.6 8V 2013>2018, Fox 1.6 8V 2015>, Voyage 1.6 8V 2013>2018, Space Fox 1.6 8V 2015>, Saveiro 1.6 8V 2014>2018

BOSCH
GI7202

REPLACES / REEMPLAZA:

Porsche: 997 605 115 01;

VW: 022 133 062 AJ;

Bosch: 0 280 750 474

APPLICATION / APLICACIÓN:

PORSCHE: 911 3.4 Carrera 1997>2001 / 3.6 Carrera 2001>2005, 911 convertible 3.4 Carrera 1998>2001 / 3.6 Carrera 2001>2005, 911 Targa 3.6 2001>2005, Boxster Spyder 3.4 RS 60 2007>2011, Cayenne 3.2 2003>2007 / 3.6 2007>2010, Cayman 2.7 / 2.9 / S 3.4 / R 3.4 2005>2013, Macan 3.0 / 3.6 2014->, Panamera 3.6 / 3.6 2010>2013

VW: Golf, Touareg, Transporter, Phaeton

BOSCH
GI7228

REPLACES / REEMPLAZA:

Citroën: 9652510380;

Bosch: 0 280 750 228

APPLICATION / APLICACIÓN:

PEUGEOT: 206 hatch 1.4i 1998->

BOSCH
GI7237

REPLACES / REEMPLAZA:

GM: 93338117;

Bosch: 0 280 750 237

APPLICATION / APLICACIÓN:

CHEVROLET: Astra 2.0 flexpower 2004>2009, Astra Sedan 2.0 flexpower 2004>2009, Vectra 2.0 flexpower 2005>2009 / 2.4 16V flexpower 2005>2009 / 2.0 flexpower Nex Edition 2009>2011, Vectra hatch 2.0 flexpower 2007>2011, S10 2.4 MPFI flexpower 2007>2012, Blazer 2.4 MPFI flexpower 2007>

FIAT
GI7296

REPLACES / REEMPLAZA:

Fiat: 55198296, 73502387, SMF00811, 44SMF8

APPLICATION / APLICACIÓN:

FIAT: Doblo, Palio 2004, Palio 2008>2012, Palio Weekend 2004>2012, Siena 2004>2013, Strada, Punto 2008>2017 all with engine 1.4 flex

FIAT
GI7306 // NEW //

REPLACES / REEMPLAZA:

FIAT: 55254306; **MAGNETI MARELLI:** 55254306, 50GTE3F; **DIPASPORT:** FLAI439N, FLAI439R

APPLICATION / APLICACIÓN:

FIAT: Linea 1.6 2011>, 500X 1.6 2014>;

JEEP: Renegade 1.6 2014>

VW
GI7310 // NEW //

REPLACES / REEMPLAZA:

VOLKSWAGEM: 030 133 062F, 445MV5

APPLICATION / APLICACIÓN:

VOLKSWAGEM: Gol, Fox, Voyage 1.0 2011>, Kombi 2009 Flex

VW
GI7330 // NEW //

REPLACES / REEMPLAZA:

VW: 07K133062A; **VEMO:** V10-81-0149; **DIPASPORT:** FLAI257R

APPLICATION / APLICACIÓN:

VW: Beetle 2.5 2011>2019, Beetle Convertible 2.5 2011>2016, New Beetle 2.5 2005>2010, Jetta (III) 2.5 2008>2010, Jetta (IV) 2.5 2010>, Golf (VI) 2.5 2009>2013

BOSCH
GI7418 // NEW //

REPLACES / REEMPLAZA:

Bosch: 0 280 750 540; **FORD:** VP4M5U-9E927-DC, VP4F9U-9E928-AC

APPLICATION / APLICACIÓN:

PEUGEOT: 301 1.6 VTI 115 2012>;

FORD: C-MAX 1.8/2.0 2007>2010, Fiesta Mk6 Hatch ST150 2005>2008, Focus C-MAX 1.8/2.0 2003>2007, Focus Mk2 Hatch/Saloon/Estate 1.8/2.0 2004>2012, Focus Mk2 Convertible 2.0 2006>2010, Galaxy Mk2 2.0/2.3 2006>2015, Mondeo Mk4 Hatch/Saloon/Estate 2.0/2.3 2007>2015, S-MAX 2.0/2.3 2006>2014

GM
GI7438

REPLACES / REEMPLAZA:

GM: 12631016, 12616438

APPLICATION / APLICACIÓN:

CHEVROLET: Colorado 3.7 2012, Impala 5.3 2009, Monte Carlo 5.3 2007

GMC: Canyon 3.7 2010>2012

HUMMER: H3 3.7 2010

VW
GI7450 // NEW //

REPLACES / REEMPLAZA:

VOLKSWAGEM: 036 133 064P; **VDO:** 408 237 730 R005, A2C92870100

APPLICATION / APLICACIÓN:

VOLKSWAGEM: Gol, Polo Classic 1.0 mi 2001>2003

GM
GI7500

REPLACES / REEMPLAZA:

GM: 12609500, S20009

APPLICATION / APLICACIÓN:

BUICK: Lucerne 3.9 2011

CHEVROLET: Impala 3.5 2011, Malibu 3.5 2010, Equinox 3.4 2009, Uplander 3.9 2007, Monte Carlo 3.5 2007

PONTIAC: G6 3.5 2010, Montana SV6 3.9 2007

GM
GI7508 // NEW //

REPLACES / REEMPLAZA:
GM: 94703005; **BOSCH:** 0 280 750 508

APPLICATION / APLICACIÓN:
CHEVROLET: Agile 1.4 flexpower 2010>2013 Nova Montana 1.4 flexpower 2011>2013, Spin 1.8 Flexpower 2012>2013, Cobalt 1.4 1.8 Flexpower 2012>2013

BMW
GI7511

REPLACES / REEMPLAZA:
BMW: 13 54 7 502 445, 7 502 445;

Vdo: 408 238 424 002Z

APPLICATION / APLICACIÓN:
BMW: Series 3 Saloon: 330i/330xi 2000>2005, Series 3 Coupe: 330Ci/330xi 2000>2006, Series 3 Convertible: 330Ci 2000>2007, Series 3 Estate: 330i/330xi 2000>2005, Series 5 Saloon: 530i 2000>2003, Series 5 Estate 530i 2000>2004, Series 7 Saloon: 730i/730Li 2003>2008, X3 3.0i XDrive 2004>2006, X5 3.0i 2000>2006, Z3 Roadster/Coupe 3.0i 2000>2003, Z4 Roadster 3.0i 2003>2005

BOSCH
GI7515

REPLACES / REEMPLAZA:
Fiat: 46533515;

Bosch: 0 280 750 042, 0 280 750 259

APPLICATION / APLICACIÓN:
FIAT: Idea MPV 1.2 16V 2004, Brava hatch 1.2 16V 2000>2001, Bravo MK1 hatch 1.2 16V 2000>2001, Punto MK2 hatch 1.2 16V;

LANCIA: Y (840A) 1.2 16V

BOSCH
GI7535 // NEW //

REPLACES / REEMPLAZA:
Bosch: 0 280 750 535

Ford: 7S7G-9F991-CA, 7S7G-9F991-AC, 7S7G9-F991-BA, 7S7Z9-E926-A, BE8Z-9E926-B

APPLICATION / APLICACIÓN:
FORD: B-Max 1.6Ti 2012>, C-Max II 1.6 2010>, Grand C-Max 1.6 2010>, Fiesta Mk7 hatch 1.6 2008>, Focus III 1.6 2010>, Galaxy Mk2 1.6 2010>2015, Kuga II 1.6 2013>, Mondeo Mk4 hatch/saloon/estate 1.6 2007>2015, S-Max 1.6 2001>2014, Transit Connect box 1.6 2013>, Tourneo Connect 1.6 2013>;

VOLVO: S60 II T3/T4/T4F 2010>2015, S80 Mk2 saloon T4/T4F 2010>, V40 hatchback T2/T3/T4 (GTDi) 2012>, V60 T3/T4/T4F 2010>2015, V70 Mk3 estate T4/1.6 T4F 2010>2015

VW
GI7537 // NEW //

REPLACES / REEMPLAZA:
VOLKSWAGEN: 030 133 062F, 445MV5, 036 133 062R, 036 1 33 062K, 030 133 062D; **VDO:** 408 238 371 R003, A2C92869300

APPLICATION / APLICACIÓN:
VOLKSWAGEN: Gol, Fox, Voyage 1.0 2011>, Kombi 2009 Flex, Gol 1.0 16V 1994>2010, Parati 1.0 16V 2001>2005, Fox 1.0 2004>2010, Polo 2007>2012, Bora Saloon 2.0 1998>2005 / 2.0 4motion, Bora Estate 2.0 4motion, Golf MK4 hatch 2.0 1998>2004, 2.0 4motion 2000>2005, Golf MK4 estate 2.0 1999>2006 / 2.0 4motion 2000>2006 / 2.0 bi-fuel 2002>2006, New Beetle 2.0 1998>2010, New Beetle convertible 2.0 2002>2010

BOSCH
GI7540

REPLACES / REEMPLAZA:
Citroën: 9672486980

Bosch: 0 280 750 540

APPLICATION / APLICACIÓN:
CITROËN: C-ELYSEE 1.6 VTi 115 2012>

PEUGEOT: 301 1.6 VTi 115 2012>

GM
GI7580

REPLACES / REEMPLAZA:
GM: 12568580, 520064, 217-2296

APPLICATION / APLICACIÓN:
CHEVROLET: Trailblazer 4.2 2001>2008

ISUZU: Ascender 4.2 2003->

SAAB: 9-7X 4.2 2005>2012

VW
GI7602 // NEW //

REPLACES / REEMPLAZA:
VOLKSWAGEN: 04E133062C

BOSCH: 0 280 750 602

APPLICATION / APLICACIÓN:
VOLKSWAGEN: Sagitar, Santana, Polo, Passat, Jetta, Touran, Magotan

FORD
GI7646 // NEW //

REPLACES / REEMPLAZA:
FORD: VP4M5U-9E927-DC, VP4F9U-9E928-AC; **VW:** 030 133 062F, 445MV5

APPLICATION / APLICACIÓN:
FORD: C-MAX 1.8/2.0 2007>2010, Fiesta Mk6 Hatch ST150 2005>2008, Focus C-MAX 1.8/2.0 2003>2007, Focus Mk2 Hatch/Saloon/Estate 1.8/2.0 2004>2012, Focus Mk2 Convertible 2.0 2006>2010, Galaxy Mk2 2.0/2.3 2006>2015, Mondeo Mk4 Hatch/Saloon/Estate 2.0/2.3 2007>2015, S-MAX 2.0/2.3 2006>2014 VOLKSWAGEN: Gol, Fox, Voyage 1.0 2011>, Kombi 2009 Flex

RENAULT
GI7699

REPLACES / REEMPLAZA:
Renault: 8200 908 869, 8200 682 611, 7700 273 699

APPLICATION / APLICACIÓN:
RENAULT: Dacia, Clio II, Kangoo Mk1 1.4 1997->, Kangoo Mk1 van 1.4 1997->, Mégane classic saloon 1.4 1996>2003, Mégane Mk1 estate 1.4e 1999>2003

VW
GI7700 // NEW //

REPLACES / REEMPLAZA:
VDO: 408 238 371 R004, A2C92869400; **VW:** 036 133 064P

APPLICATION / APLICACIÓN:
SEAT: Cordoba MK2 Saloon 2.0 2002>2009, Ibiza MK4 Saloon 2.0 2002>2009;

SKODA: Fabia MK1 hatch 2.0 1999>2008, Fabia MK1 Saloon 2.0 1999>2007, Fabia MK1 Estate 2.0 2000>2007, Octavia MK1 hatch 2.0 1999>2007, Octavia MK1 Estate 2.0 1999>2007 / 2.0 4x4 2000>2004;

VOLKSWAGEN: Gol, Polo Classic 1.0 mi 2001>2003

GM
GI7760

REPLACES / REEMPLAZA:
GM: 12572658, 12580760, 520008, 217-1620

APPLICATION / APLICACIÓN:
CADILLAC: Escalade 6.2 2008, Escalade ESV 6.2 2008

CHEVROLET: Avalanche 5.3/6.0 2008, Express 1500 5.3 2008, Suburban 1500 5.3 2008, Tahoe 4.8 2008

FIAT
GI7785

REPLACES / REEMPLAZA:
Magneti Marelli: SM600202;

Fiat: 48SMG1/G2;

GM: 93313785

APPLICATION / APLICACIÓN:
FIAT: Siena, Palio, Doblò 1.8 2003>2005;

GM: Corsa 1.8

BOSCH
GI7786

REPLACES / REEMPLAZA:

GM: 93397786;

Bosch: 0 280 750 214

APPLICATION / APLICACIÓN:

CHEVROLET: Corsa 1.0 VHC flex power 2005>2007, Corsa Sedan 1.0 VHC flexpower 2005>2007, Celta 1.0 Flexpower

GM
GI7796

REPLACES / REEMPLAZA:

GM/Opel: 12568796, 520098

APPLICATION / APLICACIÓN:

OPEL: Astra G hatch/saloon/estate/coupe/convertible 2.2 16v 2000>2005, Speedster VX220 2.2 2000->, Vectra B hatch/saloon/estate 2.2i 16v 2000>2003, Vectra C GTS hatch 2.2 16v 2002->, Vectra C Saloon 2.2 16v 2002->, Zafira A MPV 2.2 2000>2005, Zafira B MPV 2.2 2005->

SAAB: 9-3 hatch 2.0 Turbo 1998->, 9-3 Cabrio 2.0 Turbo 1998>2003, 9-3 Saloon 1.8/2.0 2002>2015, 9-3 Cabrio 2.0 2003>2015, 9-3 Estate 2.0 2005>2015

FIAT
GI7800 // NEW //

REPLACES / REEMPLAZA:

Chevrolet: 12570800, 520006, 217-2293

APPLICATION / APLICACIÓN:

Chevrolet: Buick, Cadillac, GMC

FIAT
GI7806 // NEW //

REPLACES / REEMPLAZA:

FIAT: 55227806; **VDO:** D40800044; **MAGNETI MARELLI:** GTEF4411

APPLICATION / APLICACIÓN:

FIAT: 500 2010>, Grand Siena 2012>, Fiorino 2011>, Palio 2012>2017, Uno 2011>2014, Uno Furgoneta 2011>2016, Punto 2013>2017, Strada 2013>

FIAT
GI7810

REPLACES / REEMPLAZA:

Fiat: 55227810, 36GTE3F, GTEF3611

APPLICATION / APLICACIÓN:

FIAT: Novo Uno Evo Way, Uno Vivace, Uno Attractive 1.0 8V flex, Novo Palio, Gran Siena

RENAULT
GI7870

REPLACES / REEMPLAZA:

Renault: 10287-L, 7700102870, 7700875435

APPLICATION / APLICACIÓN:

RENAULT: Clio, Scénic, Mégane todos 1.6 16v

RENAULT
GI7873 // NEW //

REPLACES / REEMPLAZA:

VW: 030 133 062D; **VDO:** 408 238 371 R004, A2C92869400

APPLICATION / APLICACIÓN:

VW: Bora Saloon 2.0 1998>2005 / 2.0 4motion, Bora Estate 2.0 4motion, Golf MK4 hatch 2.0 1998>2004, 2.0 4motion 2000>2005, Golf MK4 estate 2.0 1999>2006 / 2.0 4motion 2000>2006 / 2.0 bi-fuel 2002>2006, New Beetle 2.0 1998>2010, New Beetle convertible 2.0 2002>2010;

SEAT: Cordoba MK2 Saloon 2.0 2002>2009, Ibiza MK4 Saloon 2.0 2002>2009

FORD
GI7926

REPLACES / REEMPLAZA:

Ford: DS7Z 9E926 A, DS7Z 9E926 D

APPLICATION / APLICACIÓN:

FORD: Escape, Fusion, C-Max, Transit Connect, Ranger 2.5

FORD
GI7927

REPLACES / REEMPLAZA:

Ford: VP4M5U-9E927-DC, VP4F9U-9E928-AC

APPLICATION / APLICACIÓN:

FORD: C-MAX 1.8/2.0 2007>2010, Fiesta Mk6 Hatch ST150 2005>2008, Focus C-MAX 1.8/2.0 2003>2007, Focus Mk2 Hatch/Saloon/Estate 1.8/2.0 2004>2012, Focus Mk2 Convertible 2.0 2006>2010, Galaxy Mk2 2.0/2.3 2006>2015, Mondeo Mk4 Hatch/Saloon/Estate 2.0/2.3 2007>2015, S-MAX 2.0/2.3 2006>2014

FORD
GI7991

REPLACES / REEMPLAZA:

Ford: 9W7ZA, 33705428

APPLICATION / APLICACIÓN:

FORD: Crown Victoria V8 de 4.6, E350 Van V8 de 5.4, Lincoln, Mercury

GM
GI7992

REPLACES / REEMPLAZA:

GM: 12629992, S20019, 025623501093

APPLICATION / APLICACIÓN:

CHEVROLET: Camaro 6.2 2015, Express 2500 4.8/6.0 2015, Express 3500 4.8/6.0 2015, Silverado 2500 HD 6.0 2015, Silverado 3500 HD 2015

GMC: Savana 2500 4.8/6.0 2015, Savana 3500 4.8/6.0 2015, Sierra 2500 HD 6.0 2015, Sierra 3500 HD

GM
GI7994

REPLACES / REEMPLAZA:

GM: 025623501109, S20018

APPLICATION / APLICACIÓN:

CADILLAC: CTS 3.0 2010>2012, SRX 3.0 2011

CHEVROLET: Equinox 3.0 2011, Camaro 3.6 2010

GMC: Terrain 3.0 2010

GM
GI7995

REPLACES / REEMPLAZA:

GM: 12616995

APPLICATION / APLICACIÓN:

BUICK: Enclave 3.6 2011, LaCrosse 3.6 2011

CHEVROLET: Traverse 3.6 2011, Equinox 3.6 2009

GMC: Acadia 3.6 2011



EMS COMPONENTS | SISTEMA DE CONTROL DE MOTOR

IGNITION SENSOR | SENSOR DE IGNICIÓN

HITACHI**GS3205 // NEW //**

REPLACES / REEMPLAZA:

Hitachi: RSB03, RSB06, RSB07

APPLICATION / APLICACIÓN:

NISSAN: Pintara 2.4, Pulsar 2.0

SUBARU: Leone 1.8

CHRYSLER**GS3715 // NEW //**

REPLACES / REEMPLAZA:

Chrysler: MD611715

APPLICATION / APLICACIÓN:

CHRYSLER: Voyager Mk1 3.0 1987>1990, Voyager II 3.0/3.0i 1990>1995



EMS COMPONENTS | SISTEMA DE CONTROL DE MOTOR

IGNITION COIL | BOBINA DE IGNICIÓN

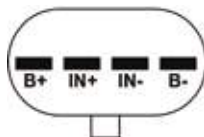
AC DELCO
GC4424

FEATURES / CARACTERÍSTICAS: 4 PIN / WITH IGNITION MODULE
REPLACES / REEMPLAZA:
GM: 12611424, 12570616, 24585662; **Ac Delco:** 12611424; **Standard:** H6T55271ZC; **Regitar:** RUF413; **Mobiletron:** CG-37; **Magneti Marelli:** BI0077MM; **Delphi:** GN10639

APPLICATION / APLICACIÓN:
GM: Onix 1.0 / 1.4 LT/LTZ 2012>;

BUICK: Allure 2008, LaCrosse 2008>2009, Rainier 2006>2007;

CADILLAC: CTS 2006>2013, Escalade 2007>2013, Escalade ESV 2007>2013, Escalade EXT 2007>2013;

CHEVROLET: Avalanche 2007>2013, Camaro 2010>2013, Caprice 2011>2013, Cheyenne 2010>2013, Cheyenne 2500 2007>2009, Colorado 2007>2012, Corvette 2005>2013, Express 1500 2008>2013 /2500 2008>2013 /3500 2008>2013 /4500 2009>2012 /Cargo 2010>2012 /Pasajeros 2010>2012, Impala 2006>2009, Monte Carlo 2007, Silverado 1500 2007>2013 /2500 2007>2009 /2500 HD 2008>2013 /3500 2007>2009 /3500 HD 2008>2013, SSR 2005>2006, Suburban 1500 2007>2013 /2500 2007>2013, Tahoe 2007>2013, Trailblazer 2006>2009 /EXT 2005>2006;

GMC: Canyon 2009>2012, Envoy 2005>2009 /XL 2005>2006 /XUV 2005, Savana 1500 2008>2013 /2500 2008>2012 /3500 2008>2012 /4500 2009>2011, Sierra 2007>2012 /1500 2008>2013 /2500 HD 2008>2013 /3500 HD 2008>2013, Yukon 2007>2013 /XL 1500 2007>2013 /XL 2500 2007>2013;

HUMMER: H2 2008>2009, H3 2008>2010, H3T 2009>2010;

ISUZU: Ascender 2005>2006; **PONTIAC:** G8 2008>2009, Grand Prix 2006>2008, GTO 2005>2006; **SAAB:** 9-7x 2005>2009

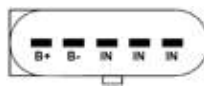
AUDI
GC4048

FEATURES / CARACTERÍSTICAS: 5 PIN / WITH IGNITION MODULE
REPLACES / REEMPLAZA:
Audi/VW: 078905104, 078905101A

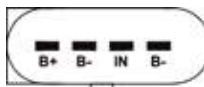
APPLICATION / APLICACIÓN:
AUDI: A4, A4 Avant, A4 Cabriolet, A6 Avant, A8

AUDI / VW
GC4115

FEATURES / CARACTERÍSTICAS: 4 PIN / WITH IGNITION MODULE
REPLACES / REEMPLAZA:
Audi/VW: 06A.905.115/S/D/R/Q, 06B.905.115H, 06B.905.115J; **Mobiletron:** CE-45; **Magneti Marelli:** BAEQ053, BI0043MM; **Standard:** UF411; **Regitar:** RUF411; **Delphi:** GN10345

APPLICATION / APLICACIÓN:
AUDI: A3 96>12 1.8 (Turbo), A4 1.8 (Turbo), A6 1.8, TT 1.8 (Turbo);

SEAT: Ibiza 00>12, Leon 99>11, Cordoba 00>07, Skoda Octavia 1.8 (Turbo);

VW: Bora, Golf, New Beetle, Passat, Polo 1.8 (Turbo)

BMW
GC4596 // NEW //

FEATURES / CARACTERÍSTICAS: 3 PIN
REPLACES / REEMPLAZA:
BMW: 12137594596, 12138616153, 12130148594, 12130390064, **DELPHI:** GN10571-12B1; **CARGO:** 150608; **HITACHI:** 134049;

MOBILETRON: CE-190

APPLICATION / APLICACIÓN:
BMW: 116 i 2007>2015, 118 i 2006>2011, 120 i 2007>, 130 i 2006>2011, 116 i 2004>2011, 118 i 2004>, 120 i 2004>2011, 130 i 2005>2011, 114 i 2011>2015, 118 i 2011>2015, 120 i 2015>2016, 125 i 2012>2019, 120 i 2015>, M 135 i 2011>, M 135 i xDrive 2012>, 1 Conversivel (E88) 118 i 2008>2013, 1 Conversivel (E88) 120 i 2008>2013, 1 Conversivel (E88) 125 i 2007>2013, 1 Conversivel (E88) 135 i 2008>2013, 1 Conversivel (E88) 135 i 2008>2013, 1 Coupé (E82) 120 i 2009>2013, 1 Coupé (E82) 125 i 2008>2013, 1 Coupé (E82) 135 i 2007>2013, 1 Coupé (E82) 135 i 2007>2013, 1 Coupé (E82) M 2011>2012, 2 Conversivel (F23) 220 i 2014>2016, 2 Conversivel (F23) 228 i 2014>, 2 Conversivel (F23) M 235 i 2014>, 2 Conversivel (F23) M 235 i xDrive 2015>, 2 Coupé (F22, F87) 220 i 2013>, 2 Coupé (F22, F87) 228 i 2014>, 2 Coupé (F22, F87) M 235 i 2013>, 2 Coupé (F22, F87) M 235 i xDrive 2014>, 2 Coupé (F22, F87) M2 2015>2018, 2 Coupé (F22, F87) M2 CS 2019>, 2 Coupé (F22, F87) M2 Competition 2018>, 3 (E46) 316 i 2002>2005, 3 (E46) 316 i 2002>2005, 3 (E46) 318 i 2001>2005, 3 (E46) 318 i 2001>2005, 3 (E46) 320 i 2000>2005, 3 (E46) 320 i 2000>2005, 3 (E46) 320 i 2000>2005, 3 (E46) 325 i 2000>2005, 3 (E46) 325 xi 2000>2005, 3 (E46) 330 i 2001>2005, 3 (E46) 330 i 2000>2005, 3 (E46) 330 xi 2000>2005, 3 (E90) 316 i 2005>2011, 3 (E90) 316 i 2004>2006, 3 (E90) 318 i 2005>2007, 3 (E90) 318 i 2007>2011, 3 (E90) 320 i 2004>2007, 3 (E90) 320 i 2007>2011, 3 (E90) 320 si 2005>2006, 3 (E90) 323 i 2005>2007, 3 (E90) 323 i 2007>2011, 3 (E90) 325 i 2006>2011, 3 (E90) 325 i 2004>2011, 3 (E90) 325 xi 2005>2008, 3 (E90) 328 i 2006>2011, 3 (E90) 330 i 2004>2011, 3 (E90) 330 i 2007>2011, 3 (E90) 330 xi 2005>2007, 3 (E90) 335 i 2006>2011, 3 (E90) 335 i 2006>2011, 3 (E90) 335 xi 2007>2008, 3 (E90) 335 xi 2006>2008, 3 (F30, F80) 316 i 2012>2016, 3 (F30, F80) 320 i 2012>2016, 3 (F30, F80) 320 i 2012>2018, 3 (F30, F80) 320 i xDrive 2012>2018, 3 (F30, F80) 328 i 2011>2018, 3 (F30, F80) 328 i xDrive 2012>2016, 3 (F30, F80) 335 i 2011>2015, 3 (F30, F80) 335 i 2011>2013, 3 (F30, F80) 335 i 2013>2015, 3 (F30, F80) 335 i xDrive 2012>2015, 3 (F30, F80) 335 i xDrive 2012>2013, 3 (F30, F80) 335 i xDrive 2013>2015, 3 (F30, F80) ActiveHybrid 2012>2015, 3 (F30, F80) ActiveHybrid 2012>2015, 3 (F30, F80) M3 2014>2018, 3 (F30, F80) M3 CS 2018>2018, 3 (F30, F80) M3 Competition 2016>2018, 3 Compact (E46) 316 ti 2002>2005, 3 Compact (E46) 316 ti 2001>2005, 3 Compact (E46) 318 ti 2001>2004, 3 Compact (E46) 318 ti 2001>2004, 3 Compact (E46) 325 ti 2001>2004, 3 Conversivel (E46) 318 Ci 2000>2006, 3 Conversivel (E46) 318 Ci 2001>2007, 3 Conversivel (E46) 318 Ci 2004>2006, 3 Conversivel (E46) 320 Ci 2006>2007, 3 Conversivel (E46) 320 Ci 2000>2007, 3 Conversivel (E46) 325 Ci 2000>2006, 3 Conversivel (E46) 330 Ci 2000>2006, 3 Conversivel (E46) M3 2001>2006, 3 Conversivel (E93) 320 i 2007>2013, 3 Conversivel (E93) 325 i 2006>2010, 3 Conversivel (E93) 330 i 2010>2013, 3 Conversivel (E93) 330 i 2007>2013, 3 Conversivel (E93) 335 i 2006>2013, 3 Conversivel (E93) 335 i 2006>2013, 3 Coupé (E46) 316 Ci 2002>2006, 3 Coupé (E46) 318 Ci 2000>2006, 3 Coupé (E46) 318 Ci 2001>2004, 3 Coupé (E46) 318 Ci 2004>2006, 3 Coupé (E46) 320 Ci 2000>2006, 3 Coupé (E46) 320 Ci 2000>2006, 3 Coupé (E46) 325 Ci 2000>2006, 3 Coupé (E46) 330 Ci 2000>2006, 3 Coupé (E46) 330 xi 2000>2006, 3 Coupé (E46) M3 2000>2006, 3 Coupé (E46) M3 CSL 2003>2003, 3 Coupé (E92) 316 i 2007>2013, 3 Coupé (E92) 320 i 2007>2013, 3 Coupé (E92) 323 i 2006>2012, 3 Coupé (E92) 325 i 2010>2013, 3 Coupé (E92) 325 i 2010>2013, 3 Coupé (E92) 325 i 2006>2010, 3 Coupé (E92) 325 xi 2006>2010, 3 Coupé (E92) 328 i 2006>2010, 3 Coupé (E92) 328 i 2006>2013, 3 Coupé (E92) 330 i 2010>2013, 3 Coupé (E92) 330 i 2006>2010, 3 Coupé (E92) 330 i xDrive 2010>2013... **CONTINUE**

BMW

GC4596 // NEW //

FEATURES / CARACTERÍSTICAS: 3 PIN

REPLACES / REEMPLAZA:

BMW: 12137594596, 12138616153, 12130148594, 12130390064, DELPHI: GN10571-12B1; CARGO: 150608; HITACHI: 134049; MOBILETRON: CE-190

APPLICATION / APLICACIÓN:

...BMW: 3 Coupé (E92) 330 xi 2006>2007, 3 Coupé (E92) 330 xi 2006>2007, 3 Coupé (E92) 335 i 2006>2013, 3 Coupé (E92) 335 i 2006>2013, 3 Coupé (E92) 335 i xDrive 2009>2013, 3 Coupé (E92) 335 i xDrive 2008>2013, 3 Coupé (E92) 335 i xDrive 2008>2013, 3 Coupé (E92) 335 xi 2007>2010, 3 Coupé (E92) 335 xi 2007>2010, 3 Gran Turismo (F34) 320 i 2013>2016, 3 Gran Turismo (F34) 320 i 2013>2016, 3 Gran Turismo (F34) 320 i xDrive 2013>2016, 3 Gran Turismo (F34) 320 i xDrive 2012>2016, 3 Gran Turismo (F34) 328 i 2013>2016, 3 Gran Turismo (F34) 328 i xDrive 2013>2016, 3 Gran Turismo (F34) 335 i 2013>2016, 3 Gran Turismo (F34) 335 i 2013>2016, 3 Gran Turismo (F34) 335 i xDrive 2013>2016, 3 Gran Turismo (F34) 335 i xDrive 2013>2014, 3 Gran Turismo (F34) 335 i xDrive 2014>2016, 3 Touring (E46) 316 i 2002>2005, 3 Touring (E46) 318 i 2001>2005, 3 Touring (E46) 320 i 2000>2005, 3 Touring (E46) 320 i 2000>2005, 3 Touring (E46) 325 i 2000>2005, 3 Touring (E46) 325 xi 2000>2005, 3 Touring (E46) 330 i 2000>2005, 3 Touring (E91) 316 i 2008>2012, 3 Touring (E91) 318 i 2006>2007, 3 Touring (E91) 318 i 2007>2012, 3 Touring (E91) 320 i 2005>2012, 3 Touring (E91) 323 i 2006>2008, 3 Touring (E91) 325 i 2004>2010, 3 Touring (E91) 325 i 2004>2008, 3 Touring (E91) 325 xi 2005>2008, 3 Touring (E91) 330 i 2005>2007, 3 Touring (E91) 330 xi 2005>2007, 3 Touring (E91) 335 i 2006>2012, 3 Touring (E91) 335 i 2006>2012, 3 Touring (E91) 335 i xDrive 2008>2012, 3 Touring (E91) 335 i xDrive 2008>2012, 3 Touring (E91) 335 xi 2007>2008, 3 Touring (E91) 335 xi 2007>2008, 3 Touring (F31) 316 i 2013>2015, 3 Touring (F31) 320 i 2012>2015, 3 Touring (F31) 320 i 2012>2015, 3 Touring (F31) 320 i xDrive 2013>2015, 3 Touring (F31) 320 i xDrive 2013>2015, 3 Touring (F31) 328 i 2012>2015, 3 Touring (F31) 328 i xDrive 2013>2016, 3 Touring (F31) 335 i 2013>2015, 3 Touring (F31) 335 i 2013>2015, 3 Touring (F31) 335 i xDrive 2013>2015, 3 Touring (F31) 335 i xDrive 2013>2015, 4 Conversivel (F33, F83) 420 i 2014>2016, 4 Conversivel (F33, F83) 420 i 2014>2016, 4 Conversivel (F33, F83) 428 i 2013>2017, 4 Conversivel (F33, F83) 428 i xDrive 2014>2016, 4 Conversivel (F33, F83) 435 i 2013>2016, 4 Conversivel (F33, F83) 435 i 2013>2016, 4 Conversivel (F33, F83) 435 i xDrive 2014>2016, 4 Conversivel (F33, F83) 435 i xDrive 2014>2016, 4 Conversivel (F33, F83) M4 2014>, 4 Conversivel (F33, F83) M4 Competition 2016>, 4 Coupé (F32, F82) 420 i 2013>2017, 4 Coupé (F32, F82) 420 i 2013>2017, 4 Coupé (F32, F82) 420 i xDrive 2013>2016, 4 Coupé (F32, F82) 420 i xDrive 2013>2016, 4 Coupé (F32, F82) 428 i 2013>2017, 4 Coupé (F32, F82) 428 i xDrive 2013>2016, 4 Coupé (F32, F82) 435 i 2013>2016, 4 Coupé (F32, F82) 435 i 2013>2016, 4 Coupé (F32, F82) 435 i xDrive 2013>2016, 4 Coupé (F32, F82) 435 i xDrive 2013>2016, 4 Coupé (F32, F82) M4 2014>, 4 Coupé (F32, F82) M4 CS 2017>2019, 4 Coupé (F32, F82) M4 Competition 2016>, 4 Coupé (F32, F82) M4 GTS 2016>2017, 4 Gran Coupe (F36) 420 i 2014>2017, 4 Gran Coupe (F36) 420 i 2014>2017, 4 Gran Coupe (F36) 420 i xDrive 2014>2016, 4 Gran Coupe (F36) 420 i xDrive 2014>2016, 4 Gran Coupe (F36) 428 i 2014>2016, 4 Gran Coupe (F36) 428 i xDrive 2014>2016, 4 Gran Coupe (F36) 435 i 2014>2016, 4 Gran Coupe (F36) 435 i xDrive 2014>2016, 4 Gran Coupe (F36) 435 i xDrive 2014>2016, 5 (E39) 520 i 2000>2003, 5 (E39) 520 i 2000>2003, 5 (E39) 525 i 2000>2003, 5 (E39) 530 i 2000>2003, 5 (E60) 520 i 2007>2010, 5 (E60) 520 i 2003>2010, 5 (E60) 523 i 2004>2007, 5 (E60) 523 i 2007>2009, 5 (E60) 525 i 2003>2005, 5 (E60) 525 i 2005>2010, 5 (E60) 525 i 2005>2009, 5 (E60) 525 xi 2005>2007, 5 (E60) 525 xi 2007>2009, 5 (E60) 530 i 2001>2005, 5 (E60) 530 i 2005>2007, 5 (E60) 530 i 2007>2009, 5 (E60) 530 i 2007>2009, 5 (E60) 530 xi 2004>2007, 5 (E60) 530 xi 2007>2008, 5 (E60) 540 i 2007>2009, 5 (E60) 545 i 2003>2005, 5 (E60) 550 i 2005>2009, 5 (F10) 520 i 2013>2016, 5 (F10) 520 i 2011>2016, 5 (F10) 520 i 2011>2016, 5 (F10) 523 i 2010>2011, 5 (F10) 528 i 2011>2016, 5 (F10) 528 i xDrive 2011>2016, 5 (F10) 530 i 2010>2013, 5 (F10) 530 i 2011>2013, 5 (F10) 535 i 2010>2016, 5 (F10) 535 i 2010>2016, 5 (F10) 535 i xDrive 2011>2016, 5 (F10) 535 i xDrive 2013>2016, 5 (F10) 550 i 2010>2013, 5 (F10) 550 i xDrive 2010>2013, 5 (F10) ActiveHybrid 2011>2016, 5 (F10) ActiveHybrid 2011>2016, 5 Gran Turismo (F07) 528 i 2013>2017, 5 Gran Turismo (F07) 535 i 2009>2017, 5 Gran Turismo (F07) 535 i xDrive 2010>2017, 5 Gran Turismo (F07) 550 i 2009>2012, 5 Gran Turismo (F07) 550 i xDrive 2010>2012, 5 Touring (E39) 520 i 2000>2003, 5 Touring (E39) 520 i 2000>2003, 5 Touring (E39) 525 i 2000>2004, 5 Touring (E39) 530 i 2000>2003, 5 Touring (E61) 523 i 2004>2007, 5 Touring (E61) 523 i 2007>2010, 5 Touring (E61) 525 i 2004>2010, 5 Touring (E61) 525 i 2005>2010, 5 Touring (E61) 525 i 2005>2010, 5 Touring (E61) 525 xi 2005>2010, 5 Touring (E61) 530 i 2004>2007, 5 Touring (E61) 530 i 2006>2010, 5 Touring (E61) 530 i 2007>2010, 5 Touring (E61) 530 i 2007>2010, 5 Touring (E61) 530 xi 2005>2007, 5 Touring (E61) 545 i 2004>2010, 5 Touring (E61) 550 i 2005>2010, 5 Touring (F11) 520 i 2011>2017, 5 Touring (F11) 520 i 2010>2017, 5 Touring (F11) 523 i 2009>2011, 5 Touring (F11) 528 i 2011>2017, 5 Touring (F11) 528 i xDrive 2011>2017, 5 Touring (F11) 530 i 2010>2013, 5 Touring (F11) 530 i 2011>2013, 5 Touring (F11) 535 i 2010>2017, 5 Touring (F11) 535 i 2013>2017, 5 Touring (F11) 535 i xDrive 2011>2017, 5 Touring (F11) 535 i xDrive 2013>2017, 5 Touring (F11) 550 i 2010>2013, 6 (E63) 630 i 2004>2007, 6 (E63) 630 i 2007>2010, 6 (E63) 630 i 2007>2010, 6 (E63) 645 Ci 2003>2005, 6 (E63) 650 i 2005>2010, 6 Conversivel (E64) 630 i 2004>2007, 6 Conversivel (E64) 630 i 2007>2010, 6 Conversivel (E64) 630 i 2007>2010, 6 Conversivel (E64) 645 Ci 2004>2005, 6 Conversivel (E64) 650 i 2005>2010, 6 Conversivel (F12) 640 i 2011>2018, 6 Conversivel (F12) 640 i xDrive 2013>2018, 6 Conversivel (F12) 650 i 2010>2012, 6 Conversivel (F12) 650 i xDrive 2011>2012, 6 Coupé (F13) 640 i 2011>2017, 6 Coupé (F13) 640 i xDrive 2013>2017, 6 Coupé (F13) 650 i 2011>2012, 6 Coupé (F13) 650 i xDrive 2011>2015, 6 Gran Coupe (F06) 640 i 2012>2018, 6 Gran Coupe (F06) 640 i xDrive 2013>2018, 7 (E65, E66, E67) 730 i, Li 2003>2008, 7 (E65, E66, E67) 730 i, Li 2003>2008, 7 (E65, E66, E67) 730 i, Li 2005>2008, 7 (E65, E66, E67) 730 i, Li 2005>2008, 7 (E65, E66, E67) 735 i, Li 2001>2005, 7 (E65, E66, E67) 740 i, Li 2005>2008, 7 (E65, E66, E67) 745 i, Li 2001>2005, 7 (E65, E66, E67) 750 i, Li 2005>2008, 7 (E65, E66, E67) 760 i, Li 2003>2008, 7 (F01, F02, F03, F04) 730 i, Li 2009>2015, 7 (F01, F02, F03, F04) 740 i, Li 2012>2015, 7 (F01, F02, F03, F04) 740 i, Li 2008>2012, 7 (F01, F02, F03, F04) 740 i, Li xDrive 2012>2015, 7 (F01, F02, F03, F04) 750 i, Li 2008>2012, 7 (F01, F02, F03, F04) 750 i, Li xDrive 2009>2012, 7 (F01, F02, F03, F04) 760 i, Li 2009>2015, 7 (F01, F02, F03, F04) ActiveHybrid 7 2010>2012, 7 (F01, F02, F03, F04) ActiveHybrid 7 2010>2012, 7 (F01, F02, F03, F04) ActiveHybrid 7 2012>2015, 7 (F01, F02, F03, F04) ActiveHybrid 7 2012>2015, 7 (G11, G12) M 760 Li xDrive 2019>, 7 (G11, G12) M 760 i, Li xDrive 2016>2019, X1 (E84) sDrive 16 i 2013>2015, X1 (E84) sDrive 18 i 2010>2015, X1 (E84) sDrive 18 i 2010>2015, X1 (E84) sDrive 20 i 2011>2015, X1 (E84) xDrive 20 i 2011>2015, X1 (E84) xDrive 25 i 2010>2011, X1 (E84) xDrive 28 i 2011>2015, X1 (E84) xDrive 28 i 2009>2011, X3 (E83) 2.0 i 2005>2008, X3 (E83) 2.5 i 2004>2006, X3 (E83) 2.5 si 2006>2008, X3 (E83) 2.5 si xDrive 2006>2008, X3 (E83) 3.0 i xDrive 2003>2006, X3 (E83) 3.0 si 2006>2008, X3 (E83) xDrive 20 i 2008>2011, X3 (E83) xDrive 25 i 2008>2010, X3 (E83) xDrive 30 i 2008>2010, X3 (F25) sDrive 20 i 2014>2017, X3 (F25) sDrive 20 i 2014>2017, X3 (F25) xDrive 20 i 2011>2017, X3 (F25) xDrive 20 i 2012>2017, X3 (F25) xDrive 28 i 2011>2012, X3 (F25) xDrive 35 i 2010>2017, X4 (F26) M 40 i 2015>2018, X4 (F26) xDrive 20 i 2014>2018, X4 (F26) xDrive 28 i 2014>2018, X4 (F26) xDrive 35 i 2014>2018, X5 (E53) 3.0 i 2000>2006, X5 (E53) 4.4 i 2003>2006, X5 (E53) 4.8 i 2004>2006, X5 (E70) 3.0 si 2006>2008, X5 (E70) 4.8 i xDrive 2006>2008, X5 (E70) M 2009>2013, X5 (E70) xDrive 30 i 2008>2010, X5 (E70) xDrive 35 i 2010>2013, X5 (E70) xDrive 35 i 2012>2013, X5 (E70) xDrive 40 i 2012>2013, X5 (E70) xDrive 48 i 2008>2010, X5 (E70) xDrive 50 i 2010>2013, X5 (F15, F85) M 2014>2018, X5 (F15, F85) xDrive 28 i 2015>2018, X5 (F15, F85) xDrive 35 i 2013>2018, X5 (F15, F85) xDrive 35 i 2013>2018, X5 (F15, F85) xDrive 40e 2015>2018, X5 (F15, F85) xDrive 40e 2015>2018, X5 (F15, F85) xDrive 40e 2015>2018, X6 (E71, E72) ActiveHybrid 2009>2011, X6 (E71, E72) xDrive 2009>2011, X6 (E71, E72) M 2009>2014, X6 (E71, E72) xDrive 35 i 2008>2014, X6 (E71, E72) xDrive 35 i 2009>2014, X6 (E71, E72) xDrive 35 i 2007>2010, X6 (E71, E72) xDrive 50 i 2008>2014, X6 (E71, E72) xDrive 50 i 2007>2014, X6 (F16, F86) M 2014>2019, X6 (F16, F86) xDrive 35 i 2014>2019, X6 (F16, F86) xDrive 35 i 2014>2019, Z3 Coupé (E36) M 2001>2003, Z3 Roadster (E36) M 3.2 2001>2003, Z4 Coupé (E86) 3.0 si 2006>2008, Z4 Coupé (E86) M 2006>2008, Z4 Roadster (E85) 2.0 i 2005>2009, Z4 Roadster (E85) 2.2 i 2003>2005, Z4 Roadster (E85) 2.5 i 2002>2005, Z4 Roadster (E85) 2.5 i 2005>2009, Z4 Roadster (E85) 2.5 si 2005>2009, Z4 Roadster (E85) 2.5 si 2006>2008, Z4 Roadster (E85) 3.0 i 2002>2005, Z4 Roadster (E85) 3.0 si 2006>2008, Z4 Roadster (E85) M 2006>2008, Z4 Roadster (E89) sDrive 18 i 2013>2016, Z4 Roadster (E89) sDrive 20 i 2011>2016, Z4 Roadster (E89) sDrive 20 i 2011>2016, Z4 Roadster (E89) sDrive 23 i 2009>2011, Z4 Roadster (E89) sDrive 28 i 2011>2016, Z4 Roadster (E89) sDrive 30 i 2009>2011, Z4 Roadster (E89) sDrive 30 i 2009>2011, Z4 Roadster (E89) sDrive 35 i 2009>2016, Z4 Roadster (E89) sDrive 35 i 2010>2016



BMW
GC4842 // NEW //
FEATURES / CARACTERÍSTICAS: 3 PIN

REPLACES / REEMPLAZA:
BMW: 12 13 7 559 842, 12 13 7 571 644, 12 13 7 582 627, 12 13 7 594 935, 12 13 7 638 477, 7 562 745; **BOSCH:** 0 221 504 471; **TRANSPO:** CUF077; **HITACHI:** 133876; **CARGO:** 150576

APPLICATION / APLICACIÓN:

BMW: 1 (E81) 116 i 2007>2011, 1 (E81) 116 i 2008>2011, 1 (E81) 118 i 2006>2011, 1 (E81) 120 i 2007>2011, 1 (E81) 120 i 2007>2012, 1 (E87) 116 i 2007>2011, 1 (E87) 116 i 2009>2011, 1 (E87) 118 i 2006>2011, 1 (E87) 120 i 2007>2011, 1 (E87) 120 i 2007>2011, 1 Conversivel (E88) 118 i 2008>2013, 1 Conversivel (E88) 120 i 2008>2013, 1 Conversivel (E88) 120 i 2007>2013, 1 Coupé (E82) 120 i 2007>2013, 3 (E90) 316 i 2007>2011, 3 (E90) 318 i 2007>2011, 3 (E90) 320 i 2007>2011, 3 (E90) 320 i 2007>2011, 3 (E90) 325 i 2007>2011, 3 (E90) 325 i 2007>2011, 3 (E90) 325 i xDrive 2008>2011, 3 (E90) 325 xi 2007>2008, 3 (E90) 330 i 2007>2011, 3 (E90) 330 i xDrive 2008>2011, 3 (E90) 330 xi 2007>2008, 3 Conversivel (E93) 318 i 2010>2013, 3 Conversivel (E93) 320 i 2007>2013, 3 Conversivel (E93) 320 i 2006>2013, 3 Conversivel (E93) 325 i 2006>2013, 3 Conversivel (E93) 325 i 2007>2013, 3 Conversivel (E93) 330 i 2007>2013, 3 Coupé (E92) 316 i 2007>2013, 3 Coupé (E92) 318 i 2010>2013, 3 Coupé (E92) 320 i 2007>2013, 3 Coupé (E92) 320 i 2007>2013, 3 Coupé (E92) 325 i 2010>2013, 3 Coupé (E92) 325 i 2007>2013, 3 Coupé (E92) 325 i xDrive 2008>2013, 3 Coupé (E92) 325 xi 2007>2008, 3 Coupé (E92) 330 i 2007>2013, 3 Coupé (E92) 330 i xDrive 2010>2013, 3 Coupé (E92) 330 xi 2007>2010, 3 Touring (E91) 316 i 2008>2012, 3 Touring (E91) 318 i 2007>2012, 3 Touring (E91) 318 i 2007>2012, 3 Touring (E91) 320 i 2007>2012, 3 Touring (E91) 320 i 2007>2012, 3 Touring (E91) 325 i 2007>2012, 3 Touring (E91) 325 i xDrive 2008>2012, 3 Touring (E91) 325 xi 2007>2008, 3 Touring (E91) 330 i 2007>2012, 3 Touring (E91) 330 i xDrive 2007>2012, 3 Touring (E91) 330 xi 2007>2012, 5 (E60) 520 i 2006>2010, 5 (E60) 520 i 2007>2009, 5 (E60) 523 i 2007>2009, 5 (E60) 523 i 2007>2009, 5 (E60) 525 i 2007>2010, 5 (E60) 525 i 2007>2010, 5 (E60) 525 i xDrive 2008>2010, 5 (E60) 525 xi 2007>2009, 5 (E60) 530 i 2007>2009, 5 (E60) 530 i xDrive 2008>2009, 5 (E60) 530 xi 2007>2008, 5 (F10) 523 i 2009>2011, 5 (F10) 523 i 2010>2011, 5 (F10) 528 i 2010>2011, 5 (F10) 530 i 2011>2013, 5 Touring (E61) 520 i 2007>2010, 5 Touring (E61) 520 i 2007>2010, 5 Touring (E61) 523 i 2007>2010, 5 Touring (E61) 523 i 2007>2010, 5 Touring (E61) 525 i 2007>2010, 5 Touring (E61) 525 i 2007>2010, 5 Touring (E61) 525 i xDrive 2008>2010, 5 Touring (E61) 530 i 2007>2010, 5 Touring (E61) 530 i 2006>2008, 5 Touring (F11) 523 i 2009>2011, 5 Touring (F11) 528 i 2009>2011, 5 Touring (F11) 530 i 2011>2013, 6 (E63) 630 i 2007>2010, 6 Conversivel (E64) 630 i 2007>2010

BOSCH
GC4000
FEATURES / CARACTERÍSTICAS: 3 PIN / WITH IGNITION MODULE

REPLACES / REEMPLAZA:
Bosch: 0 986 221 000; **VW:** 6NO.905.104; **Magneti Marelli:** BI0015MM, BAEQ008; **Mobiletron:** IG-H016K; **Standard:** UF364; **WAI/Transpo:** CUF364

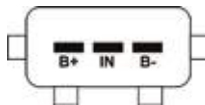
APPLICATION / APLICACIÓN:
VW: Golf III 1.8, 2.0, Polo Classic 1.8, 2.0; **AUDI:** A80, 91-98, Seat Cordoba 1.0, 1.8 95-02, Ibiza 1.0, 1.8 95-02, Toledo 1.8

BOSCH
GC4001
FEATURES / CARACTERÍSTICAS: 3 PIN / WITH IGNITION MODULE

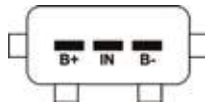
REPLACES / REEMPLAZA:
Bosch: 0 221 601 001; **VW:** 6N.090.510.5; **Magneti Marelli:** BAEQ005; **Mobiletron:** CE-01; **Regitar:** RUF104S

APPLICATION / APLICACIÓN:
AUDI: A3 >98; **SEAT:** Cordoba 1.4/1.6 Todos; **VW:** Golf, Logus, Passat Alemão 1.8, Pointer, Polo Classic >98

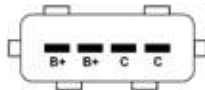
BOSCH
GC4004
FEATURES / CARACTERÍSTICAS: 4 PIN / WITHOUT IGNITION MODULE

REPLACES / REEMPLAZA:
Bosch: 221503004, 221503025, 597048, 597060; **Citroën/ Peugeot:** 597048, 597060

APPLICATION / APLICACIÓN:
CITROËN: Berlingo (MF), Xantia (X1), Xsara (N1), Xsara Break; **PEUGEOT:** 106 II (1), 205 I Cabriolet (741B, 20D), 306 Break (7E, N3, N5), 406 Break (8E/F), Partner Kasten (5), Boxer Pritsche/ Fahrgestell (ZCT_)

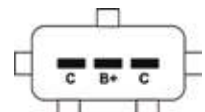
BOSCH
GC4005
FEATURES / CARACTERÍSTICAS: 3 PIN / WITHOUT IGNITION MODULE

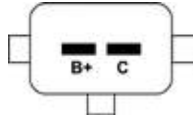
REPLACES / REEMPLAZA:
Bosch: F 000 ZS0 202, F 000 ZS0 205; **GM:** 93.275.309; **Mobiletron:** CE-63; **Magneti Marelli:** BAEQ066; **Regitar:** RCE63; **OE:** 96228897

APPLICATION / APLICACIÓN:
GM: Ipanema 2.0 (MPFI) 04/96>11/97, Kadett 2.0 (MPFI) 12/96>12/98, Vectra CD 2.0 16V, Vectra GLS 2.0 (MPFI) 04/96>, Vectra GSI 2.0 16V 10/93>

BOSCH
GC4007

FEATURES / CARACTERÍSTICAS: 2 PIN / WITHOUT IGNITION MODULE

REPLACES / REEMPLAZA:
Bosch: 0221502007, 0221502008; **VW/Audi/Suzuki:** 330905115A; **Magneti Marelli:** 060717001012, BAEQ001; **Suzuki:** 330905115A; **Mobiletron:** CE-15; **Regitar:** RCE15

APPLICATION / APLICACIÓN:
VW: Santana 1994>2004

BOSCH
GC4011

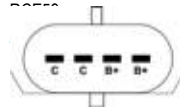
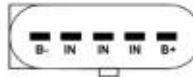
FEATURES / CARACTERÍSTICAS: 4 PIN / WITHOUT IGNITION MODULE

REPLACES / REEMPLAZA:
Bosch: 221503011; **GM:** 90506102; **Opel:** 1208076; **Lucas:** DMB824; **Mobiletron:** CE-59; **Regitar:**
APPLICATION / APLICACIÓN:
VECTRA: Vectra 2.0 16V 1996>, Vectra 2.0 16V SFI 96>

BOSCH
GC4043

FEATURES / CARACTERÍSTICAS: 5 PIN / WITH IGNITION MODULE

REPLACES / REEMPLAZA:
Bosch: 0 986 221 015; **VW:** 021 905 106

APPLICATION / APLICACIÓN:
VW: Corrado 2.9 VR6 91>95, Golf Mk3 Hatch 2.8 VR6/2.9 VR6 Syncro 92>97, Golf Mk3 Estate 2.9 VR6 Syncro 94>99, Passat Mk3/4 Saloon/Estate 2.8 VR6 91>97, Sharan 2.8 VR6/2.8 VR6 Syncro 95>00, Vento 2.8 VR6 92>98, Transporter T4 Minibus 2.8 VR6 00>03, Transporter T4 Van 2.8 VR6 96>03;

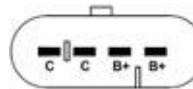
FORD: Galaxy Mk1 2.8i V6/2.8i V6 4x4 95>00;

MERCEDES-BENZ: V-Klass V280 97>03

BOSCH
GC4045

FEATURES / CARACTERÍSTICAS: 4 PIN / WITHOUT IGNITION MODULE

REPLACES / REEMPLAZA:
Bosch: 986221027;

Magneti Marelli: BAE506D, BI0019MM;

Fiat: 7582152, 7663177

APPLICATION / APLICACIÓN:
FIAT: Panda, Panda Van, Tempra, Tempra S.W, Tipo (160_), Uno;

Lancia: Y10 (156_)

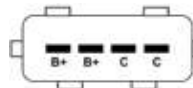
BOSCH
GC4049

FEATURES / CARACTERÍSTICAS: 4 PIN / WITHOUT IGNITION MODULE

REPLACES / REEMPLAZA:
Bosch: 0986221029;

Citroën: 597045

APPLICATION / APLICACIÓN:
CITROËN: AX 86>98, XM 89>14, XM Break 89>94, ZX 91>99;

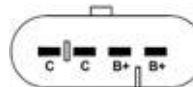
PEUGEOT: 106 I 91>96, 106 II, 306 Break, Partner Combispac, Partner Kasten

BOSCH
GC4050

FEATURES / CARACTERÍSTICAS: 4 PIN / WITHOUT IGNITION MODULE

REPLACES / REEMPLAZA:
Bosch: 0986221037; **Fiat:** 7746151, 7582152

APPLICATION / APLICACIÓN:
FIAT: Croma, Fiorino, Fiorino Kasten, Fiorino Pick up, Tempra, Tempra S.W, Tipo 160, Uno (146_);

LANCIA: Thema SW

BOSCH
GC4116
FEATURES / CARACTERÍSTICAS: 2 PIN / WITHOUT IGNITION MODULE

REPLACES / REEMPLAZA:
Bosch: F 000 ZS0 116; **Honda:** 30510-PT2-006; **Mobiletron:** CH-03; **Magneti Marelli:** BAEQ022, BI0033MM; **Standard:** UF89; **Regitar:** RUF89

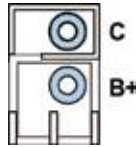
APPLICATION / APLICACIÓN:
HONDA: Civic 1.6i 91-00, Prelude 2.2, 96-00, Accord 2.0, 2.2 93-02

BOSCH
GC4128 // NEW //
FEATURES / CARACTERÍSTICAS:
REPLACES / REEMPLAZA:
Bosch: 1 227 030 059; **ERA:** 880128; **FIAT:** 7793212

APPLICATION / APLICACIÓN:
ALFA ROMEO: 145 Hatch 1.4/ 1.6/ 1.8/ 2.0 1996>2001

BOSCH
GC4164 // NEW //
FEATURES / CARACTERÍSTICAS: WITHOUT IGNITION MODULE

REPLACES / REEMPLAZA:
Bosch: F 000 ZS0 117; **Toyota:** 19500 74100, 90919 02164; **Mobiletron:** CT07; **Regitar:** RUF103; **Meat & Doria:** 10387; **Transpo:** 48093; **Beru:** ZS356; **Bremi:** 20163; **NGK:** 48093

APPLICATION / APLICACIÓN:
TOYOTA: Avensis Mk1 hatch/saloon/estate 1.6 1997>2000, Carina Mk2 hatch/saloon/estate 2.0 GLI 1987>1992, Celica coupe 1.8i 16v 1993>1999, Corolla hatch/saloon/estate 1.6 1983>1988, Hilux V Pickup 1.8 1988>1998, Paseo Mk2 1.5 1995>1999, Starlet hatch 1.3 1984>1989, Hi-Ace Mk3 minibus 2.0 1989>1998

BOSCH
GC4174
FEATURES / CARACTERÍSTICAS: 4 PIN | WITH IGNITION MODULE

REPLACES / REEMPLAZA:
Bosch: 0221601012;

Renault: 74 01 2751 74

APPLICATION / APLICACIÓN:
VOLVO: C70 I Coupe 1997>2002 2.0/ 2.3/ 2.5, C70 I Cabriolet 2.0/ 2.3 1998>2005, S70 1996>2000 2.0/ 2.3/ 2.4/ 2.5, V70I 96>00 2.0/ 2.3/ 2.5, 850 2.0/ 2.3/ 2.4/ 2.5 1991>1997, 850 Kombi 2.0/ 2.3/ 2.5 1992>1997;

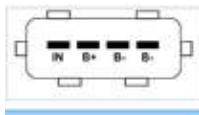
RENAULT: Safrane II 1996>2000 2.5 20V

BOSCH
GC4203
FEATURES / CARACTERÍSTICAS: 3 PIN / WITHOUT IGNITION MODULE

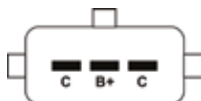
REPLACES / REEMPLAZA:
Bosch: F 000 ZS0 200, F 000 ZS0 203; **GM:** 93.248.876; **Mobiletron:** CE-35; **Standard:** UF705; **Regitar:** RCE35

APPLICATION / APLICACIÓN:
GM: Astra 2.0 16V (SFI) 02/99>05/05, Sedan 1.8 (MPFI - gas.) 10/98>09/01 / 2.0 10/98>03/04, Astra, Zafira 2.0 (Flexp.) 04/04>, Astra Sedan 1.8 (MPFI - álc.) 05/01>05/05, Astra Sedan 2.0 16V (SFI) 02/99>03/04, Astra, Sedan 2.0 Multipower (GNV+Flex) 10/04>, Vectra 2.0 8V (MPFI - gas.) 01/03>05/05 / 2.2 12/97>12/02, Vectra 2.2 16V (SFI) 12/97>05/05, Vectra GT, GTX SOHC (Flexp.) 09/07>, Vectra 2.0/2.4 8V (Flexp.) 10/05>, Zafira 2.0 16V 04/01>05/05 / 1.8/2.0/2.4 16V 04/01>02/04

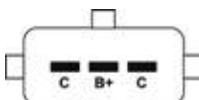
BOSCH
GC4206
FEATURES / CARACTERÍSTICAS: 3 PIN / WITHOUT IGNITION MODULE

REPLACES / REEMPLAZA:
Bosch: F000 ZS0 206, F000 ZS0 207; **Fiat:** 46752948; **Magneti Marelli:** MMBI0023; **Mobiletron:** CE-36; **Regitar:** RCE36; **Original code:** 55189636

APPLICATION / APLICACIÓN:
FIAT: Dobló 1.3 Mpi 16V 01-06, Palio/ Siena/ Weekend 1.0/ 1.3 Mpi 16V, Fire 1.0 8V 01-05.

BOSCH
GC4210
FEATURES / CARACTERÍSTICAS: 4 PIN / WITH IGNITION MODULE

REPLACES / REEMPLAZA:
Bosch: F000ZS0210, F000ZS0209; **VW:** 032.905.106B/ C/ D; **Magneti Marelli:** BI0017MM, BAEQ042; **Delphi:** CE20118; **Mobiletron:** IG-B018K; **Standard:** UF277; **Regitar:** RUF277

APPLICATION / APLICACIÓN:
AUDI: A3 1.6 99-06;

VW: Fox 1.0, 1.4, 1.6 Total Flex 03>, Polo/ Sedan, Total Flex 04>, Gol III, IV, V 1.0 Mi, 1.0 Turbo, 1.6, 05>, Kombi 1.4 Total Flex 06>, Golf IV 1.6 06-08, Parati 1.0 Mi 16V

BOSCH
GC4212
FEATURES / CARACTERÍSTICAS: 3 PIN / WITHOUT IGNITION MODULE

REPLACES / REEMPLAZA:
Bosch: F000ZS0212; **Ford:** 88SF-12029-A2A, 928F-12029-CA, 7U2Z-12029-A, 928F12029CA; **Mobiletron:** CF-02; **Magneti Marelli:** BAEQ036; **Regitar:** RFD487

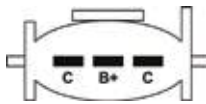
APPLICATION / APLICACIÓN:
FORD: Courier 1.3, 1.4 97-99, Escort/ SW 1.8 /2.0 16V 98-02, Fiesta 1.0, 1.3, 1.4 96-99, Ka 1.0, 1.3 97-99, Ranger 2.3, 2.5i, 94-01

BOSCH
GC4213
FEATURES / CARACTERÍSTICAS: 3 PIN / WITHOUT IGNITION MODULE

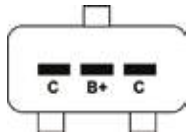
REPLACES / REEMPLAZA:
VW: 026 905 105; **BOSCH:** F 000 ZS0 213; **Standard:** UF715; **Regitar:** RUF692; **Magneti Marelli:** BI0059MM

APPLICATION / APLICACIÓN:
VW: Gol III 1.6Mi Flex 05.03-08.05 /1.8Mi Flex 02.05-08.05, Gol IV 1.6 Flex 08.05-06.08 /1.8 Flex 08.05-06.08, Parati III 1.6Mi Flex 05.03-8.05 /1.8Mi Flex 02.05-08.05, Parati IV 1.6 Flex 09.05 /1.8 Flex 09.05-12.08, Saveiro III 1.6Mi Flex 05.03-08.05 /1.8Mi Flex 02.05-08.05, Saveiro IV 1.6 Flex 09.05-08.09 /1.8 Flex 09.05-08.09

BOSCH
GC4233 // NEW //
FEATURES / CARACTERÍSTICAS: 3 PIN

REPLACES / REEMPLAZA:
Bosch: F 000 ZS0 233; **mitsubishi:** CA160034

APPLICATION / APLICACIÓN:
MITSUBISHI: Pajero/Montero TR4 2.0 Flex 2007>2015, L200 Triton 2.4 Flex 2013>2016

BOSCH
GC4235
FEATURES / CARACTERÍSTICAS: 3 PIN - WITHOUT SUPORT / WITHOUT IGNITION MODULE

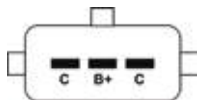
REPLACES / REEMPLAZA:
Bosch: F 000 ZS0 235; **Fiat:** 55226876, 55230507; **Regitar:** RFT235; **Magneti Marelli:** BI0058MM

APPLICATION / APLICACIÓN:
FIAT: Uno 1.0 flex motor fire EVO 05.10>

BOSCH
GC4243
FEATURES / CARACTERÍSTICAS: 3 PIN - WITH SUPORT / WITHOUT IGNITION MODULE

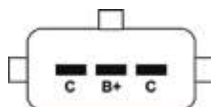
REPLACES / REEMPLAZA:
Bosch: F 000 ZS0 243; **Fiat:** 55229930 ; **Magneti Marelli:** BI0101MM

APPLICATION / APLICACIÓN:
FIAT: Doblo 1.8 MPI 16V/ Adventure Locker, Idea 1.6 16V /1.8 16V /Adventure, Palio 1.6 MPI 16V /1.8 MPI 16V Weekend Adventure, Punto 1.6 16V /1.8 16V, Siena 1.6 MPI 16V, Strada 1.8 MPI 16V (Todos Flex E.torQ 08.10>).

BOSCH
GC4262 // NEW //
FEATURES / CARACTERÍSTICAS: 4 PIN / WITHOUT IGNITION MODULE

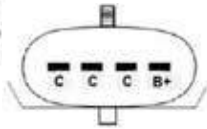
REPLACES / REEMPLAZA:
Bosch: 0 221 503 017; **Opel:** 1208075, 90541062, 90563160; **Transpo:** CUF379; **Mobiletron:** CE-76; **Meat & Doria:** 10510; **Beru:** ZS306; **ERA:** 880157

APPLICATION / APLICACIÓN:
OPEL: Calibra A 2.5i V6 1993>1997, Omega B Saloon/ Estate 2.5/3.0 V6 1994>2001, Sintra 3.0 i 24V 1996>1999, Vectra B hatch 2.5 1995>2000, Vectra B saloon i 500 2.5 1998>2000, Vectra B estate i 500 2.5 1998>2000

BOSCH
GC4310 // NEW //
FEATURES / CARACTERÍSTICAS:
REPLACES / REEMPLAZA:
Bosch: 0 986 221 048; **HITACHI:** 138425; **CARGO:** 150435; **BERU:** ZSE003

APPLICATION / APLICACIÓN:
Audi: A1 1.2 2010>2015, A1 sportback 1.2 2012>2015, A2 hatch 1.4 2000>2005, A3 MK 1 hatch 1.6, 1.8 1996>2003, A3 MK 2 hatch 1.2 1.6 2010>2012, A3 convertible 1.2, 1.6 2010>2013, A4 mk 1 saloon/avant/estate 1.6 1994>2001, A4 MK 2 saloon/avant/estate 1.6 2000>2004, A4 MK 3 saloon/avant/estate 1.6 2004>2008
Seat: Alhambra MPV 2.0 1996>2010, Altea MPV 1.2, 1.6 2014, Altea XL MPV 1.2, 1.6 2009>2010, Arosa hatch 1.0, 1.4 1997>2004, Cordoba MK 1 saloon/estate 1.0, 1.4 1996>2002, Cordoba MK 2 saloon 1.6, 2.0 2002>2009, Exeo 1.6, 1.8 2009>2010, Exeo ST 1.6, 1.8 2009>2010, Ibiza MK 2 hatch 1.0, 1.4 1996>2002, Ibiza MK 4 hatch 1.4, 1.6, 2.0 2002>2009, Ibiza MK 5 hatch 1.2 2010>2012, Ibiza sportcoupe 1.2 2010>2012, Ibiza IV ST 1.2 2010>2012, Inca van 1.4 1995>2003, Leon MK 1 hatch 1.4, 1.6 1.8 1999>2006, Leon MK 2 hatch 1.2, 1.6 2005>2012, Toledo MK 2 saloon 1.4, 1.6, 1.8 1998>2006, Toledo MK 3 1.6 2004>2009, Toledo IV 1.2 2012>2015
Skoda: Fabia MK 1 hatch/saloon/estate 1.4, 2.0 1999, 2008, Octavia MK 1 hatch/estate 1.4, 1.6, 2.0 1997>2007, Octavia MK 2 hatch/estate 1.6 2008>2013, SuperB MK 1 saloon 2.0 2001>2008
Vw: Bora saloon/estate 1.4, 1.6, 1.8, 2.0 2000>2005, Caddy MK 2 estate 1.4 2000>2004, Caddy MK 2 van 1.4 1995>2004, Caddy III estate 1.6 2004>2015, Caddy MK 3 van 1.6 2004>2005, Golf MK 4 hatch/estate/cabriolet 1.4, 1.6, 2.0 1997>2006, Golf MK 5 estate 1.6 2007>2009, Lupo hatch 1.4, 1.6 1998>2005, New beetle 1.6, 2.0 1998>2010, New beetle convertible 1.6 2003>2010, Passat MK 5 saloon/estate 1.6 1997>2005, Polo MK3 hatch 1.6 1998>1999, Polo classic MK 3 saloon 1.4, 1.6 1995>2001, Polo MK 3 estate 1.4 1998>2001, Polo MK 3F hatch 1.0, 1.4, 1.6 1999>2001, Polo MK 4/4F hatch 1.4 2001>2008, Touran 1.6 2003>2010, Transporter T5 minibus/van/flatbed 2.0 2003>2015

BOSCH
GC4346
FEATURES / CARACTERÍSTICAS: 3 PIN / WITHOUT IGNITION MODULE

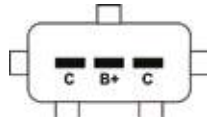
REPLACES / REEMPLAZA:
Fiat: 7789346; **Bosch:** 0986221003; **Mobiletron:** CE-44; **Magneti Marelli:** BAEQ067; **Regitar:** RCE44

APPLICATION / APLICACIÓN:
FIAT: Brava 1.6 16V (MPI) 08/99>06/03, Doblo 1.6 16V (MPI) 11/01>08/03, Marea, Marea Weekend 1.6 16V (MPI) 06/05>, Palio 1.6 16V (MPI) 04/96>02/03, Palio Weekend 1.6 16V (MPI) 05/97>02/03, Siena 1.6 16V (MPI) 10/97>02/03, Strada 1.6 16V (MPI) 02/98>02/03

BOSCH
GC4371
FEATURES / CARACTERÍSTICAS: 4 PIN / WITHOUT IGNITION MODULE

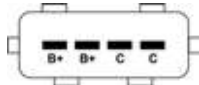
REPLACES / REEMPLAZA:
Bosch: F 01R 00A 036, F 01R 00A 025

APPLICATION / APLICACIÓN:
CHERY: QQ 2012

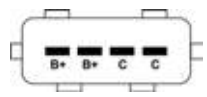
BOSCH
GC4372
FEATURES / CARACTERÍSTICAS: 4 PIN / WITHOUT IGNITION MODULE

REPLACES / REEMPLAZA:
Chery: A11-3705110EA; **Bosch:** 0221503465; **Mobiletron:** CY12; **Regitar:** RCY12

APPLICATION / APLICACIÓN:
CHERY: Tiggo, Riich V5, Eastar, A3, A5, SQR481 1.6L, SQR484 1.8L 2.0L engine; Chery A1, QQ6, SQR473 1.3L engine; Chery A5, E5, Fulwin2, Cowin, SQR477 1.5L engine; Chery Fulwin, Cowin, SQR480 1.6L engine; Buick Sail Epica; Chana CM5; **HAFEI:** Lobo, DA468, DA46.

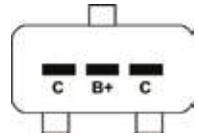
BOSCH
GC4407
FEATURES / CARACTERÍSTICAS: 3 PIN / WITHOUT IGNITION MODULE

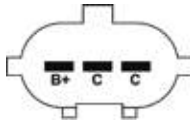
REPLACES / REEMPLAZA:
Alfa Romeo: 60558152, 60809606; **Bosch:** 0221503407; **Ferrari:** 134386, 7648797; **Land Rover:** ERR6045, ERR6566; **VW:** 48.905.105.1; **Fiat:** 134386, 7648797; **Mobiletron:** CE-37; **Magneti Marelli:** BAEQ037, BI0022MM; **Standard:** UF306; **Regitar:** RUF545

APPLICATION / APLICACIÓN:
ALFA ROMEO: 155 2.0 92-96, 164 2.0 92-98;
FIAT: Tipo 1.6 IE, 1.6 Mpi 93-97, Uno 1.6 Mpi 94-95, Fiorino 1.6 Mpi 95-96;
VW: Gol/ Parati II/ III, 2.0 Mi 16V Gti 95-00;
LAND ROVER: Discovery/ Range Rover 4.0 94-04

BOSCH
GC4421

FEATURES / CARACTERÍSTICAS: 3 PIN / 2 COILS / WITHOUT IGNITION MODULE

REPLACES / REEMPLAZA:

Bosch: 0 986 221 004; **Hyundai:** 27301-22040, 27301-22050; **Standard:** UF176; **Wells:** C1113; **USA Group:** C1113, UF178; **Beru:** 0040100264; **Mobiletron:** CK-20; **Regitar:** RUF176; **Meat&Doria:** 10441

APPLICATION / APLICACIÓN:

HYUNDAI: Accent L4-1.5L 1995>1999, Accent 1.3 1994>2000, Excel 1.3

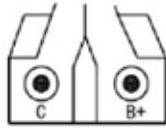
BOSCH
GC4437 // NEW //

FEATURES / CARACTERÍSTICAS: WITHOUT IGNITION MODULE

REPLACES / REEMPLAZA:

Bosch: 0 221 505 437; **MB:** A 000 150 04 80, A 000 158 68 03, 000 150 04 80, 000 158 68 03; **Mobiletron:** CE47; **Regitar:** RUF392; **Meat & Doria:** 10366; **Bremi:** 20153; **Beru:** ZS313

APPLICATION / APLICACIÓN:

MERCEDES BENZ: C-Class Saloon C180/C200 1993>2000, C-Class Estate C180T/C200T 1996>2011, E-Class Saloon 200E/220E 1992>1993, E-Class Kombi estate 220TE 1992>1993, E-Class Coupe 220CE 1992>1993, E-Class Saloon/Estate E200/E220 1993>1995, E-Class convertible E200/E220 1993>1998

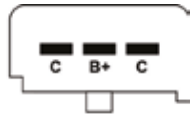
BOSCH
GC4485

FEATURES / CARACTERÍSTICAS: 3 PIN / WITHOUT IGNITION MODULE

REPLACES / REEMPLAZA:

Bosch: 0 221 503 485, 0 221 503 487; **Ford:** 4M5G12029ZA, 4M5G12029ZB, 1352562, 1459278, 1350562; **Volvo:** 30731416, 30731419, 31216444, 31216444-AA, 4S7G-12029-AB; **Mobiletron:** CF-62; **Magneti Marelli:** BAE680DX, BI0071MM; **Standard:** UF654; **Regitar:** RCF62; **Delphi:** GN10205; **Era:** 880103; **Meat&Doria:** 10462; **Transpo:** CUF772A

APPLICATION / APLICACIÓN:

FORD: Courier /Van 1.6i, EcoSport 1.6i, Fiesta 1.0i/Sedan /1.6i/Sedan, Focus 1.6i 8V /Sedan, Ka 1.0i/1.6i (Todos Flex Zetec Rocam 01.08>), Mondeo 1.8L

BOSCH
GC4490

FEATURES / CARACTERÍSTICAS: 3 PIN / WITHOUT IGNITION MODULE

REPLACES / REEMPLAZA:

Ford: 988F12029-BA, **Mazda:** L813-18-100; **Mobiletron:** CF-69; **Magneti Marelli:** BAEQ038; **Regitar:** RCF69

APPLICATION / APLICACIÓN:

Ford: Fiesta Mk IV / V, Fiesta Van, Escort Mk VII, Courier 1.3, Ka 1.3i, Street Ka, Mondeo Mk II / III, Puma, Cougar, Focus, Escape, Fusion, **Mazda:** Demio

BOSCH
GC4502 // NEW //



FEATURES / CARACTERÍSTICAS: 3 PIN / WITH IGNITION MODULE

REPLACES / REEMPLAZA:

Bosch: 0 986 221 006; **Hyundai:** 27301-02502; **Mobiletron:** CK-03; **Meat & Doria:** 10361; **Bremi:** 20173; **ERA:** 880059; **Transpo:** CUF2709

APPLICATION / APLICACIÓN:

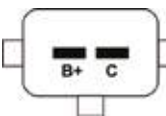
HYUNDAI: Amica 1.0i 1998>2000

BOSCH
GC4504

FEATURES / CARACTERÍSTICAS: 2 PIN / WITHOUT IGNITION MODULE

REPLACES / REEMPLAZA:

Bosch: 9220081504, F000ZS0105; **Magneti Marelli:** BI0016MM; **VW:** 377 905 105 D; **Delphi:** CE10105; **Mobiletron:** CE-16; **Magneti Marelli:** BAEQ002; **Regitar:** RUF1313; **Standard:** UF690

APPLICATION / APLICACIÓN:

VW: Gol, Parati, Quantum, Santana, Saveiro

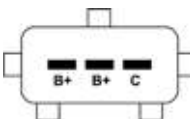
BOSCH
GC4505

FEATURES / CARACTERÍSTICAS: 3 PIN / WITH SUPORT / WITHOUT IGNITION MODULE

REPLACES / REEMPLAZA:

Bosch: 9 220 081 505; **Magneti Marelli:** BAE 504L, BAE Q020, BI0047MM; **Renault:** 7 700 749 450, 7 702 205 459, 7 702 218 697; **Delphi:** CE20053-12B1; **Mobiletron:** CE-31; **Regitar:** RCE31

APPLICATION / APLICACIÓN:

RENAULT: CLIO 1.6 8V 96-99, R19 1.6 8V 93-00, TRAFIC 1.6 8V 93-00, TWINGO 1.2i 93-97.

BOSCH
GC4506
FEATURES / CARACTERÍSTICAS: 3 PIN / WITH IGNITION MODULE

REPLACES / REEMPLAZA:
Bosch: F000ZS0104, 9220081506; **VW:** 377 905 105B; **Original Code:** GW100 18 100; **Delphi:** CE10104; **Mobiletron:** CE-83; **Magneti Marelli:** BAEQ003; **Standard:** UF693; **Regitar:** RUF1312

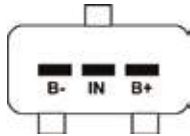
APPLICATION / APLICACIÓN:
VW: Gol II 1.0 8V 98-05, Kombi 1.6 Mpi, 98-05

BOSCH
GC4509
FEATURES / CARACTERÍSTICAS: 4 PIN / WITHOUT IGNITION MODULE

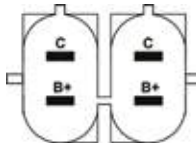
REPLACES / REEMPLAZA:
Bosch: 9220081509; **GM:** 93 230 798; **Delphi:** CE10509; **Magneti Marelli:** BI0024MM; **Mobiletron:** CE-101; **Regitar:** RUF1311

APPLICATION / APLICACIÓN:
GM: Ipanema, Kadett, Monza 1.8 /2.0 Efi 91-97.

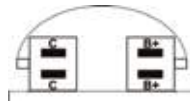
BOSCH
GC4510
FEATURES / CARACTERÍSTICAS: 4 PIN / WITHOUT IGNITION MODULE

REPLACES / REEMPLAZA:
Bosch: 9 220 081 510; **Delphi:** CE10510; **GM:** 93.230.799; **Magneti Marelli:** BI0011MM; **Mobiletron:** CE-03; **Regitar:** RCE03; **Transpo:** CUF1011; **OE:** 1208003

APPLICATION / APLICACIÓN:
GM: Corsa 1.0/1.4 (EFI) 04/94>12/96

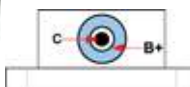
BOSCH
GC4602
FEATURES / CARACTERÍSTICAS: 2 PIN / WITHOUT IGNITION MODULE

REPLACES / REEMPLAZA:
Bosch: 022506002, 0221506003, 0221506444, 0221506445; **Mercedes Benz:** 0001587003, 0001587103; **Daewoo:** 0001587003, 0001587503; **Volkswagen:** 00A905105; **Skoda:** 00A 905 105; **Delphi:** CE20038-12B1; **Mobiletron:** CE-57; **Standard:** UF137; **Regitar:** RUF527

APPLICATION / APLICACIÓN:
Mercedes Benz: E-Class, SL, S-Class, C-Class, G-Class, SLK, Coupe, Saloon, Kombi, C230, C280, C36 AMG, E320, S320, SL320, 300CE, 300E, 300TE.

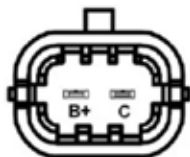
BOSCH
GC4605 // NEW //
FEATURES / CARACTERÍSTICAS: 2 PIN

REPLACES / REEMPLAZA:
Bosch: 1 227 030 071; **Alfa Romeo:** 46755605; **Transpo:** CUF015; **Mobiletron:** CE-104; **Meat & Doria:** 10310; **Beru:** ZS361; **Bremi:** 20175; **ERA:** 880079; **Cargo:** 150440

APPLICATION / APLICACIÓN:
ALFA ROMEO: 147 Hatch 1.6/2.0 16V T. Spark 2001>2010, 156 saloon/estate 1.6/1.8/2.0 16V T. Spark 1997>2005, 166 saloon 2.0 T. Spark 2000>2007, GT 1.8 TS 2003>2010, GTV coupe Mk2 2.0 T. spark 16V 1995>2005, Spider 2.0 T. spark 16V 1995>2005

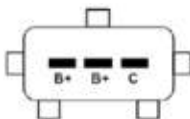
BOSCH
GC4643 // NEW //
FEATURES / CARACTERÍSTICAS: 3 PIN / WITHOUT IGNITION MODULE

REPLACES / REEMPLAZA:
Bosch: 0 986 221 026; **Renault:** 7700100643; **Mobiletron:** CE30; **Meat & Doria:** 10347; **Beru:** ZS243; **Bremi:** 11723; **Transpo:** CUF2607

APPLICATION / APLICACIÓN:
RENAULT: Clio Mk2 Hatch 1.4/1.6 1998>2005, Kangoo Mk1 van 1.4 1997>2008, Megane Mk1 hatch 1.6 1996>1999, Megane classic saloon 1.6 1996>1999, Megane Mk1 coupe 1.6 1996>1999, Megane convertible 1.6 1996>1999, Scenic Mk1 MPV 1.6 1996>1999

BOSCH
GC4956
FEATURES / CARACTERÍSTICAS: 3 PIN / WITHOUT IGNITION MODULE

REPLACES / REEMPLAZA:
Bosch: F000ZS0215;

GM/ Delco: 93312956

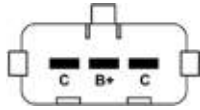
APPLICATION / APLICACIÓN:
OPEL: Astra G CC, Astra G Cabriolet, Corsa C, Corsa C Kasten, Meriva, Zafira A, Zafira B Van

BOSCH
GC4033
FEATURES / CARACTERÍSTICAS: 3 PIN / WITHOUT IGNITION MODULE

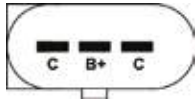
REPLACES / REEMPLAZA:
Bosch: 0 221 503 018, 0 221 503 033; **MB:** 0 001 501 380, 000 150 12 80, 000 150 07 80; **Mobiletron:** CE-69; **Magneti Marelli:** BAEQ139, BI0053MM; **Regitar:** RCE69

APPLICATION / APLICACIÓN:
MERCEDES BENZ: Classe A 1.6 (A160), Classe A 1.9 (A190) 05/99>05/05, Vaneo 1.6 /1.9 02>05

BOSCH
GC4059 // NEW //
FEATURES / CARACTERÍSTICAS: 4 PIN / WITHOUT IGNITION MODULE

REPLACES / REEMPLAZA:
Bosch: 0 221 503 014; **Opel:** 01208306, 1208306, 90532618, 90543059; **Transpo:** CUF003; **Mobiletron:** CE-68; **Regitar:** RCE68; **Meat & Doria:** 10326; **Bremi:** 20335; **Beru:** ZS358; **NGK:** 4802

APPLICATION / APLICACIÓN:
OPEL: Agila 1.0 12v 2000>2007, Corsa B hatch 1.0i 12v 1996>2000, Corsa C hatch 1.0 2000>2003

BOSCH
GC4194 // NEW //
FEATURES / CARACTERÍSTICAS: WITH IGNITION MODULE

REPLACES / REEMPLAZA:
Bosch: 0 986 221 094; **Fiat:** 71739285; **Opel:** 01208026, 01208553, 1208553, 1208026, 12567686, 12569342, 12580537; **NGK:** 48146; **Mobiletron:** CE188; **Meat & Doria:** 10481; **Transpo:** CUF2784

APPLICATION / APLICACIÓN:
OPEL: Astra G hatch/ saloon/ estate/ coupe/ convertible 2.2 16v 2000>2005, Speedster VX220 2.2 2000->, Vectra B hatch/saloon/estate 2.2i 16v 2000>2003, Vectra C GTS hatch 2.2 16v 2002->, Vectra C saloon 2.2 16v 2002->, Zafira A MPV 2.2 16v 2000>2005;

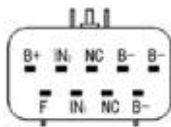
FIAT: Croma estate 2.2 16v 2005>

BOSCH
GC4313 // NEW //
FEATURES / CARACTERÍSTICAS:
REPLACES / REEMPLAZA:
Bosch: 0 221 503 031; **OPEL:** 09195819, 90564334, 9195819, 1208213; **TRANSPRO:** CUF056; **MOBILETRON:** CE158; **MEAT & DORIA:** 10523

APPLICATION / APLICACIÓN:
OPEL: Omega B Saloon 2.2 16V 1999>2003

BOSCH
GC4318 // NEW //
FEATURES / CARACTERÍSTICAS: 6 PIN

REPLACES / REEMPLAZA:
Bosch: 0 221 503 031; **BMW:** 12131247281; **BREMI:** 11732; **MEAT & DORIA:** 10382; **MOBILETRON:** CE-157

APPLICATION / APLICACIÓN:
BMW: Serie 3 316i / 318i / 318ti / 1982>2006, Serie 5 518i 1987>1996, Z3 Roadster 1.8i/1.9i 1995>2003

BOSCH
GC4353 // NEW //
FEATURES / CARACTERÍSTICAS: 6 PIN / WITHOUT IGNITION MODULE

REPLACES / REEMPLAZA:
Bosch: 0 221 503 015; **Opel:** 01208012, 1208012, 90543253, 90560110; **Transpo:** CUF022; **Bremi:** 20184; **Mobiletron:** CE70; **Regitar:** RCE70; **Meat & Doria:** 10327

APPLICATION / APLICACIÓN:
OPEL: Agila 1.2 16V 2000>2007, Astra G hatch/ saloon/ estate 1.2 16V 1998>2005, Corsa B hatch 1.2i 16V 1998

BOSCH
GC4469 // NEW //
FEATURES / CARACTERÍSTICAS:
REPLACES / REEMPLAZA:
Bosch: 0 221 503 469; **Opel:** 09153250, 9153250, 93172030; **TRANSPO:** CUF069; **MOBILETRON:** CE162; **MEAT&DORIA:** 10531

APPLICATION / APLICACIÓN:
OPEL: Signum 2.2 direct 2003>, Vectra C GTS hatch 2.2 2002>2008, Vectra C saloon/estate 2.2 2003>2008, Zafira B MPV 2.2 2005>2012

BOSCH
GC4472 // NEW //
FEATURES / CARACTERÍSTICAS: 6 PIN / WITHOUT IGNITION MODULE

REPLACES / REEMPLAZA:
Bosch: 0 221 503 472; **Opel:** 01208020, 12 08 020, 24420584, 93177212; **Transpo:** CUF038; **Mobiletron:** CE-79; **Regitar:** RCE79; **Meat & Doria:** 10463; **Beru:** ZS338; **Bremi:** 20189; **NGK:** 48083

APPLICATION / APLICACIÓN:
OPEL: Agila 1.2 16V Twinport 2004>2007, Astra G hatch/saloon/estate 1.4 2007>2009, Astra H hatch/estate 1.2 2005>2010 / 1.4 2004>2010 / 1.4 LPG 2009>2010, Astra H GTC hatch 1.4 2005>2010, Combo tour MPV 1.4 2004>, Combo van body/estate 1.4 16V 2005>, Corsa C hatch 1.2 2000>2009 / 1.2 Twinport 2004>2009 / 1.4 Twinport 2003>2009, Corsa C van 1.2 2002> / 1.4 2003>, Corsa D hatch 1.2/1.4 2006>, Corsa D van 1.2 2009>, Mervia 1.4 16V Twinport 2004>2010, Tigra Twintop convertible 1.4 2004>2010

BOSCH
GC4806 // NEW //
FEATURES / CARACTERÍSTICAS: 5 PIN / WITHOUT IGNITION MODULE

REPLACES / REEMPLAZA:
Bosch: 0 221 503 471; **Opel:** 93180806, 9318080, 24420622, 93180806, 01208028; **Transpo:** CUF067; **Mobiletron:** CE118; **Meat & Doria:** 10483; **Beru:** ZS359; **ERA:** 880125

APPLICATION / APLICACIÓN:
OPEL: Agila 1.0 2003>2007, Corsa C hatch 1.0 2003>2009, Corsa D hatch 1.0 2006>2010

BOSCH
GC4006
FEATURES / CARACTERÍSTICAS: 3 PIN / WITH IGNITION MODULE

REPLACES / REEMPLAZA:
Bosch: 0 221 504 006; **Fiat:** 46.403.328; **Lancia:** 46.403.328; **Mobiletron:** CE-96; **Magneti Marelli:** BAE680CY; **Regitar:** RCE96

APPLICATION / APLICACIÓN:
FIAT: Coupé 2.0 20V 10/96>03/98, Coupé 2.0 20V Turbo 10/96>09/00, Marea 2.0 20V 10/96>02/99, Marea / Marea Weekend 2.0 20V 05/98>09/00, Marea / Marea Weekend 2.0 20V Turbo >00;

LANCIA: Kappa 96/10

BOSCH
GC4008
FEATURES / CARACTERÍSTICAS: 4 PIN / WITH IGNITION MODULE

REPLACES / REEMPLAZA:
Bosch: 0221604008; **Magneti Marelli:** BAE 680AR, BAE Q103; **Valeo:** 245175; **Delphi:** GN10334-12B1; **Volvo:** 9125601, 30713416; **Mobiletron:** CE-129; **Standard:** UF341; **Regitar:** RUF341

APPLICATION / APLICACIÓN:
Volvo: C70 I Cabriolet, C70 I Coupé S60/ S70 (P80_), S80 (TS, XY), V70 I Combi (P80_), V70 II Combi (P80_), XC70 CROSS COUNTRY, XC 90, **CHEVROLET:** CRUZE (J300) 1.6 09>

BOSCH

GC4013 // NEW //



FEATURES / CARACTERÍSTICAS:
REPLACES / REEMPLAZA:
Bosch: F 01R 00A 013, F 01R 02A 013; **GEELY:** 3705100-EG01
APPLICATION / APLICACIÓN:
Great Wall Voleex: C30 2010>2014.
FLORID: 2013>2015

BOSCH

GC4014

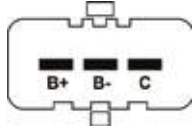

FEATURES / CARACTERÍSTICAS: 3 PIN / WITHOUT IGNITION MODULE
REPLACES / REEMPLAZA:
Bosch: 0 221 504 014; **Fiat:** 46.467.542; **Lancia:** 46.467.542; **Mobiletron:** CE-98; **Magneti Marelli:** BAE680AM; **Regitar:** RCE98
APPLICATION / APLICACIÓN:
FIAT: Coupé 2.0 20V 04/98>09/00, Marea 2.0 20V 03/99>09/02, Marea / Marea Weekend 2.0 20V Turbo 12/98>03/07, Marea / Marea Weekend 2.4 20V 07/00>05/05;
LANCIA: Kappa 07>10, Lybra 99>10, Thesis 02>09

BOSCH

GC4035

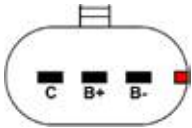

FEATURES / CARACTERÍSTICAS: 3 PIN / WITHOUT IGNITION MODULE
REPLACES / REEMPLAZA:
Bosch: 0221504035; **Fiat:** 55231256; **Bougicord:** 155230; **ERA:** 880375
APPLICATION / APLICACIÓN:
FIAT: Panda, Punto, 500;
ALFA ROMEO: Mito;
LANCIA: Ypsilon

BOSCH

GC4039

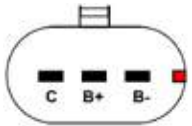

FEATURES / CARACTERÍSTICAS: 3 PIN / WITHOUT IGNITION MODULE
REPLACES / REEMPLAZA:
Bosch: 0221504039
APPLICATION / APLICACIÓN:
FIAT: 500X 1.6 09>14, Argo 1.8 HGT 2017>, Renegade 1.6 07>14

BOSCH

GC4061 // NEW //



FEATURES / CARACTERÍSTICAS:
REPLACES / REEMPLAZA:
Bosch: F 01R 00A 061
APPLICATION / APLICACIÓN:
LIFAN: 330 1.3/1.5 2010>, 530 1.3/1.5/1.8 2013>, 620 1.3/1.5/1.8 2014>

BOSCH

GC4069 // NEW //

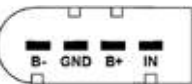

FEATURES / CARACTERÍSTICAS: 4 PIN / WITH IGNITION MODULE
REPLACES / REEMPLAZA:
Bosch: 860210413; **Beru:** ZSE042; **Bremi:** 20651; **Regitar:** RUF660; **Mobiletron:** CE-204; **Meat & Doria:** 10697
APPLICATION / APLICACIÓN:
PORSCHE: Cayenne S 4.8 2007>2010, Cayenne GTS 4.8 2007>2010, Cayenne Turbo S 4.8 2007>2015, Panamera 3.6 2010>2013, Panamera 4.8 S 2009>2013, Panamera 4.8 Turbo 2010>2016

BOSCH
GC4070 // NEW //
FEATURES / CARACTERÍSTICAS: WITH IGNITION MODULE

REPLACES / REEMPLAZA:
Bosch: 0 986 221 070; **Porsche:** 948 602 104 00, 948 602 104 01, 948 602 104 03, 948 602 104 05, 948 602 104 07, 948 602 104 08, 948 602 104 09, 948 602 104 20, 948 602 104 21; **Beru:** ZSE012; **Bremi:** 20652; **Mobiletron:** CE-154; **Regitar:** RUF563;

Meat & Doria: 10698

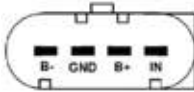
APPLICATION / APLICACIÓN:
PORSCHE: Carrera GT 5.7 2003>2006, Cayenne S 4.5 2002>2007, Cayenne Turbo 4.5 2002>2007, CayenneTurbo S 4.5 2004>2007

BOSCH
GC4072 // NEW //
FEATURES / CARACTERÍSTICAS: 4 PIN / WITH IGNITION MODULE

REPLACES / REEMPLAZA:
Bosch: 0 986 221 072; **Audi/ Seat/ Skoda/ VW:** L06K 905 110 G, 06H 905 110 D, 06H 905 110 E, 06H 905 110 F, 06H 905 110 G, 06J 905 110 E, 06J 905 110 F, 06J 905 110 G, 06J 905 110 K, 06K 905 110 C, 06K 905 110 D, 06K 905 110 G, 06L 905 110 C, 06L 905 110 D, 06L 905 110 E; **Porsche:** 958 905 110 00, 958 905 110 01; **Beru:** ZSE137; **Bremi:** 20529; **Mobiletron:** CE-174; **Regitar:** RCE174; **Transpo:** CUF2102; **Meat & Doria:** 10660

APPLICATION / APLICACIÓN:
AUDI: A1 1.8 TFSI 2015> / 2.0 TFSI quattro 2012>, A3 1.8 TFSI 2012> / S3 quattro 2012>, A3 Sportback 1.8 TFSI 2012> / 1.8 TFSI Si quattro 2013>, A3 Limousine 1.8 TFSI 2013> / 1.8 TFSI Si quattro 2013>, A3 Convertible 1.8 TFSI 2013> / 1.8 TFSI quattro, A4 Mk4 Saloon / Avant/Estate 1.8/2.0 TFSI 2011>2015, A4 Allroad 2.0 TFSI quattro 2013>2016, A5 Coupe 1.8/2.0 TFSI 2007>2017, A5 Sportback/Convertible 1.8/2.0 TFSI 2011>2015, A6 1.8 TFSI 2014>, Q5 2.0 TFSI quattro 2013>, TT 2.0 TFSI quattro 2014>;

SEAT: Leon 1.8 TSI 2013>, Leon SC 1.8 TSI 2013>, Leon ST 1.8 TSI 2013>;

SKODA: Octavia III TSI 2012>, Octavia III Combi 1.8 TSI 2012>;

VOLKSWAGEN: Golf VI Convertible 2.0 TSI 2013>, Gol VII 2.0 GTI 2013>, Jetta IV 2.0 TSI 2012>;

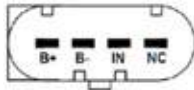
PORSCHE: Cayenne 2.9 S 2017>, Macan 2.0 2014>, Panamera 4.0 Turbo S E-Hybrid 2017>, Panamera Sport Turismo 4.0 Turbo E-Hybrid 2017>

BOSCH
GC4076 // NEW //
FEATURES / CARACTERÍSTICAS: 2 PIN / WITHOUT IGNITION MODULE

REPLACES / REEMPLAZA:
Bosch: 0 986 221 076; **Hyundai/ Kia:** 27301 03110; **Meat & Doria:** 10626; **Bremi:** 20523; **NGK:** 49048; **Transpo:** CUF2114

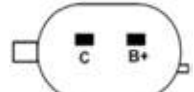
APPLICATION / APLICACIÓN:
HYUNDAI: i20 1.2 2012>2015, i20 1.2 2008>2015, i20 1.2 2014>;

KIA: Picanto 1.2 2011>, Rio III 1.25 CVVT 2011>

BOSCH
GC4096
FEATURES / CARACTERÍSTICAS: 3 PIN / WITHOUT IGNITION MODULE

REPLACES / REEMPLAZA:
Bosch: 0 221 504 024; **FIAT:** 55213613; **Mobiletron:** CE-187; **Regitar:** RCE187

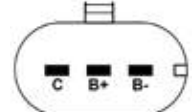
APPLICATION / APLICACIÓN:
FIAT: Punto 1.4 16v T-Jet;

ALFA ROMEO: Mito 1.4 I.E. Turbo 08>, Mito 1.4 bifuel 2011>

BOSCH
GC4154 // NEW //
FEATURES / CARACTERÍSTICAS: 4 PIN / WITH IGNITION MODULE

REPLACES / REEMPLAZA:
Bosch: 0 986 221 054; **VW/Audi:** 077 905 115 AA, 077 905 115 E, 077 905 115 F, 077 905 115 G, 077 905 115 H, 077 905 115 J, 077 905 115 K, 077 905 115 M, 077 905 115 P, 077 905 115 Q, 077 905 115 R, 077 905 115 T; **Transpo:** CUF074; **Mobiletron:** CE148; **Meat & Doria:** 10504; **Beru:** ZSE061; **Bremi:** 20126; **NGK:** 48088; **Era:** 880268

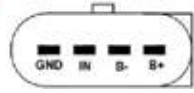
APPLICATION / APLICACIÓN:
VW: Phaeton 4.2 V8 4motion 2003>2016, Touareg 4.2 V8 2002>2006;

AUDI: A4 Mk2 saloon/avatr/estate S4 quattro 2003>2004, A4 convertible S4 quattro 2004>2009, A4 Mk3 saloon/avant/estate S4 quattro 2004>2008, A5 coupe S5 quattro 2007>2012, A6 Allroad Mk1 4.2 V8 quattro 2002>2005, A6 Mk3 saloon/avant/estate 4.2 quattro 2004>2006, A8 Mk2 saloon 3.7/4.2 quattro 2005>2010

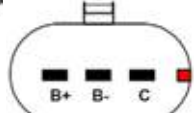
BOSCH
GC4162 // NEW //
FEATURES / CARACTERÍSTICAS: 3 PIN / WITHOUT IGNITION MODULE

REPLACES / REEMPLAZA:
Bosch: 0 986 221 042; **Delphi:** CE20062-12B1; **Fiat:** 46777286, 55180004; **Transpo:** CUF031; **Mobiletron:** CE71; **Regitar:** RCE71; **Meat & Doria:** 10331; **Bremi:** 20380; **Beru:** ZS320

APPLICATION / APLICACIÓN:
FIAT: Bravo Mk1 hatch 1.6 2000>2001, Doblo MPV 1.6 16v 2001->, Doblo cargo van 1.6 16v 2001->, Multipla MPV 1.6 16v 2000>2010, Palio weekend estate 1.6 16v 2001->, Stilo hatch 1.6 16v 2001>2006, Stilo estate 1.6 16v 2003>2008

BOSCH
GC4186
FEATURES / CARACTERÍSTICAS: 2 PIN / WITHOUT IGNITION MODULE

REPLACES / REEMPLAZA:
Denso: MB029700-8040; **JAGUAR:** LCA1510AB; **MOBILETRON:** CE-121; **STANDARD:** UF-347; **TRANSPO:** CUF2463

APPLICATION / APLICACIÓN:
JAGUAR: VANDEN PLAS 99, XJ8 1998, XK8 1997>1999, XK Coupe/XK 8 Cabrio 4.0 1996>2005

BOSCH
GC4247 // NEW //
FEATURES / CARACTERÍSTICAS: 4 PIN / WITH IGNITION MODULE

REPLACES / REEMPLAZA:
Bosch: 0 986 221 047; **VW:** 03D 905 115 A, 03D 905 115 B, 03D 905 115 C, 03D 905 115 D, 03D 905 115 E, 03D 905 115 F, 03D 905 115 G, 03D 905 715 A; **Seat:** 03D 905 115 F; **Skoda:** 03D 905 115 F, 03D 905 715 A; **Transpo:** CUF071; **Mobiletron:** CE-149; **Regitar:** RCE149; **Meat & Doria:** 10460; **Bremi:** 20116; **ERA:** 880166; **NGK:** 48015

APPLICATION / APLICACIÓN:
VW: Fox hatch 1.2 2005>2010, Polo Mk4 hatch 1.2 2002>2009;

SEAT: Ibiza Mk4 hatch 1.2 2007>2008;

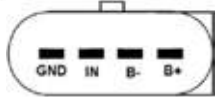
SKODA: Fabia Mk1 hatch/saloon/estate/van 1.2 2001>2007, Fabia Mk2 hatch/estate 1.2 2006>2014

BOSCH
GC4345 // NEW //
FEATURES / CARACTERÍSTICAS: 3 PIN

REPLACES / REEMPLAZA:
BMW: 12 13 7 523 345, 12 13 7 548 553, 12 13 7 594 936, 7 523 345, 7 548 553, 7 594 936; **Bosch:** 0 221 504 465; **NGK:** 48216; **Delphi:** GN10586; **Cargo:** 150574; **Hitachi:** 134047; **Mobiletron:** CE-171; **Transpo:** CUF064

APPLICATION / APLICACIÓN:
BMW: 1 (E87) 130 i 2005>2007, 3 (E90) 323 i 2005>2007, 3 (E90) 325 i 2006>2011, 3 (E90) 325 xi 2005>2008, 3 (E90) 330 i 2004>2011, 3 (E90) 330 xi 2005>2007, 3 Touring (E91) 325 i 2004>2010, 3 Touring (E91) 325 xi 2005>2008, 3 Touring (E91) 330 i 2005>2007, 3 Touring (E91) 330 xi 2005>2007, 5 (E60) 523 i 2004>2007, 5 (E60) 525 i 2005>2010, 5 (E60) 525 xi 2005>2007, 5 (E60) 530 i 2005>2007, 5 (E60) 530 xi 2004>2007, 5 Touring (E61) 523 i 2004>2007, 5 Touring (E61) 525 i 2005>2010, 5 Touring (E61) 525 xi 2005>2010, 5 Touring (E61) 530 i 2004>2007, 5 Touring (E61) 530 xi 2005>2007, 6 (E63) 630 i 2004>2007, 6 Conversivel (E64) 630 i 2004>2007, 7 (E65, E66, E67) 730 i, Li 2005>2008, Z4 Roadster (E85) 2.5 i 2005>2009, Z4 Roadster (E85) 2.5 si 2005>2009, Z4 Roadster (E85) 3.0 si 2006>2008

BOSCH
GC4428 // NEW //
FEATURES / CARACTERÍSTICAS: 3 PIN / WITH IGNITION MODULE

REPLACES / REEMPLAZA:
Bosch: 0 986 221 079; **Renault/ Dacia:** 224332428R; **MB:** A2819060000; **Nissan:** 2244800Q0F; **Smart:** 2819060000; **Meat & Doria:** 10713; **Bremi:** 20653; **ERA:** 880377; **Mobiletron:** CE-218

APPLICATION / APLICACIÓN:
DACIA: Dokker 1.2 Tce 2012>, Duster 1.6 SCe 115 2015>, Logan IIT Ce 90 2012>, Sandero TCe 90 2012>;

RENAULT: Captur 1.2 TCe 120 2016>, Clio IV 1.2 TCe 120 2013>, Kangoo Mk2 1.2 TCe 115 2013>, Megane III Hatchback 1.2 Tce 2012>, Scenic 1.2 Tce 2012>, Twingo III 1.0 SCe 70 2014>;

SMART: Fortwo Coupe/Hatchback 0.9/1.0 2014>;

NISSAN: Juke 1.2 2014>, Micra V 0.9 2016>, Pulsar Hatchback 1.2 DIG-T 2014>;

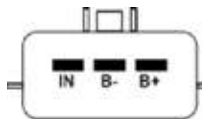
MERCEDES-BENZ: Citan box/combi 112 2013>

BOSCH
GC4448
FEATURES / CARACTERÍSTICAS: 3 PIN / WITH IGNITION MODULE

REPLACES / REEMPLAZA:
Bosch: 0986221090; **Hitachi:** 224481KTOA, 224481KT1A, 22448JA00C/A, 22448 ED000; **Wai/Transpo:** CUF549,

Mobiletron: CN-45; **Meat & Doria:** 10642; **Wells:** C1696

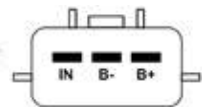
APPLICATION / APLICACIÓN:
NISSAN: Cube, Juke, Micra IV, Note, Tiida Schrägheck, X-Trail, Evalia Bus;

RENAULT: Koleos

BOSCH
GC4461
FEATURES / CARACTERÍSTICAS: 3 PIN / WITHOUT IGNITION MODULE

REPLACES / REEMPLAZA:
Bosch: 0221504461, 0221504473;

Lada: 2112-3705010;

Meat&Doria: 10699;

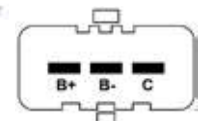
NGK: U5023

APPLICATION / APLICACIÓN:
LADA: 110, 111, 112 (All 1.5/1.6 1995>), Priora Hatchback 1.6 2008>, Priora Saloon 1.6 2008>, Priora Estate 1.6 2009>, Samara Hatch 1986>06, Samara Saloon 1987>2006, Kalina 1.6

BOSCH
GC4515 // NEW //

FEATURES / CARACTERÍSTICAS:

REPLACES / REEMPLAZA:

Bosch: 0 986 221 050; **DELPHI:** GN10445-12B1; **AUDI:** 07C905115H, 07C905115E, 07C905115, 07C905115C, 07C 905 715, 07C 905 715A, 07C 905 115J

APPLICATION / APLICACIÓN:

AUDI: A8 6.0 W12 Quattro 2001>2010; **VW:** Passat 4.0 W8 4Motion 2001>2004, Passat Variant 4.0 W8 4Motion 2001>2004, Phaeton 6.0 W12 4Motion 2002>2016, Touareg 6.0 W12 2004>2010

BOSCH
GC4604

FEATURES / CARACTERÍSTICAS: 4 PIN / WITH IGNITION MODULE

REPLACES / REEMPLAZA:

Bosch: 0 221 604 112; **Alfa Romeo/ Fiat:** 71753911, 71751445, 71741133; **GM/ Saab/ Cadillac:** 12629037, 1258351; **Meat & Doria:** 10548; **Mobiletron:** CC-33; **Regitar:** RUF375; **Trranspo:** CUF375

APPLICATION / APLICACIÓN:

ALFA ROMEO: 159 Saloon/Estate 3.2 JTS/3.2 JTS Q4 05>11, Brera Hatch 3.2 JTS/3.2 JTS Q4 2006>2011, Spider 3.2 JTS/3.2 JTS Q4 2006>2011

CADILLAC: CTS 2.8/3.6 2005>2007, CTS 3.6/3.6 AWD 2008->, CTS Coupe 3.6 2008->, SRX 3.6/3.6 AWD 2004>2008, STS 3.6 2004>2007

OPEL: Signum 2.8 V6 Turbo 2005->, Vectra C GTS Hatch 2.8 V6 Turbo 2005->, Vectra C Saloon 2.8 V6 Turbo 2005->/2.8 V6 Turbo OPC 2006>2008, Vectra C Estate 2.8 V6 Turbo 2005->

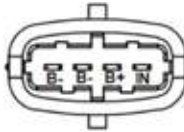
SAAB: 9-3 Saloon/Estate 2.8 V6 Turbo/2.8 V6 Turbo XWD 2005>2015, 9-3 Cabrio 2.8 V6 Turbo 2006>2015

BOSCH
GC4680 // NEW //

FEATURES / CARACTERÍSTICAS: 3 PIN

REPLACES / REEMPLAZA:

Bosch: F 000 ZS1 426; **PEUGEOT/CITROËN:** 9810992680

APPLICATION / APLICACIÓN:

CITROËN: Aircross 1.6 16V FlexStart 2015>, C3 Picasso 1.6 16V FlexStart 2015, C3 1.6 FlexStart 2015>;

PEUGEOT: 308 1.6i Flex 2015>2016, 208 1.6 FlexStart 2015>

BOSCH
GC4687 // NEW //

FEATURES / CARACTERÍSTICAS: 2 PIN / WITHOUT IGNITION MODULE

REPLACES / REEMPLAZA:

Bosch: 0 221 505 423; **Ford:** 6485688, 91XF 12029 AA, 91XF 12029 BA; **Transpo:** CUF020; **Mobiletron:** CF65; **Regitar:** RCF65; **Meat & Doria:** 10486; **Bremi:** 20190

APPLICATION / APLICACIÓN:

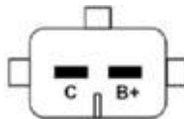
FORD: Escort Mk5 Hatch RS 2000 1991>1992, Escort Mk6 hatch RS 2000 1992>1995, Escort Mk7 hatch RS 2000 1995>1998, Galaxy Mk1 2.3 16V 1997>2006, Scorpio Mk2 saloon/estate 2.0i/2.3i 16V 1994>1998, Transit Mk6 2.3 16V 2001>2006

BOSCH
GC4715

FEATURES / CARACTERÍSTICAS: 4 PIN / WITH IGNITION MODULE

REPLACES / REEMPLAZA:

Bosch: 0986221023; **VW/Audi/Skoda/Seat:** 036905715, 036905715A/C/E/F/G, 036905100A/B/C/D; **Delphi:** CE20030-12B1;

Magneti Marelli: BAE408AE/245, BAE680AU, BAEQ062, 060801016010; **Valeo:** 245141; **Lucas:** DMB807; **Mobiletron:** CE-51; **Standard:** UF691; **Regitar:** RCE51

APPLICATION / APLICACIÓN:

VW: Golf IV Estate, Golf IV, Jetta IV, Jetta IV Estate, Polo, New Beetle Convertible, Touran, Rabbit V, Bora, Caddy, CC, EOS, Lupo, Passat, Scirocco, Sharan, Tiguan;

Audi: A1, A2, A3, A4 1.4/1.6/2.0 with motor FSI and TFSI;

Seat: Alhambra, Altea, Altea XL, Arosa, Cordoba, Ibiza, Inca, Leon, Toledo;

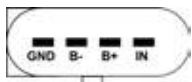
Skoda: Fabia, Octavia, Rapid, Roomster, Roomster Praktik, Superb, Yeti.

BOSCH
GC4782

FEATURES / CARACTERÍSTICAS: 4 PIN / WITH IGNITION MODULE

REPLACES / REEMPLAZA:

Bosch: 0 221 604 103; **FIAT/ ALFA ROMEO:** 46794782; **MEAT & DORIA:** 10313; **MOBILETRON:** CE-165;

Regitar: RCE165; **TRANSPO:** CUF2829

APPLICATION / APLICACIÓN:

ALFA ROMEO: 156 Saloon/ Estate 2.0 JTS 2002>2006, GT 2.0 JTS 2003>2010, GTV Coupe MK 2.0 JTS 2003>2005, Spider 2.0 JTS 2003>2005

BOSCH

GC4800

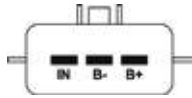

FEATURES / CARACTERÍSTICAS: 3 PIN / WITH IGNITION MODULE

REPLACES / REEMPLAZA:

Nissan: 22448-ED800, 22448-ED800EP, 22448-C100A; **Bosch:** 0 221 604 014, 0 221 604 015, 0 221 604 020, 1 220 703 040; **Renault:** 7701065086; **Standard:** UF-591; **Beru:** 0040102506; **Mobiletron:** CN-35; **Magneti Marelli:** BAE680AS, BI0109MM; **Regitar:** RUF591; **Delphi:** GN10317; **Transpo:** CUF066

APPLICATION / APLICACIÓN:

NISSAN: Sentra 2.0 10.06>04.09, Tiida 1.8 Hatchback 03.07>

BOSCH

GC4801

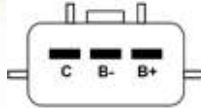

FEATURES / CARACTERÍSTICAS: 3 PIN / WITHOUT IGNITION MODULE

REPLACES / REEMPLAZA:

Renault: 8200699627; **Bosch:** 0221504030; **Mobiletron:** CE-150; **Magneti Marelli:** BAE680DA; **Regitar:** RCE150

APPLICATION / APLICACIÓN:

RENAULT: Fluence 2.0 16V flex, zGrand Scenic 2.0 16V 09>, Latitude 2.0 16V 11>, Megane CC 2.0 CVT 10>, Megane Coupe 2.0 16V 08>, Megane Estate 2.0 16V 09>, Megane Hatchback 08>

BOSCH

GC4802

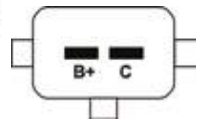

FEATURES / CARACTERÍSTICAS: 2 PIN / WITHOUT IGNITION MODULE

REPLACES / REEMPLAZA:

Bosch: 0 221 500 802; **MOBILETRON:** CM-09; **REGITAR:** RCM09

APPLICATION / APLICACIÓN:

JAC; BYD;

MITSUBISHI: Carisma 1.8 16V GDI DA2A 1997-2006 /1.8 GDI DA2A 1997-2003 /Saloon 1.8 GDI DA2A 1999-2003, Shogun Pinin 1.8 2002-2006, Space star 1.8 GDI DG5A 1998-2004

BOSCH

GC4919 // NEW //



FEATURES / CARACTERÍSTICAS:

REPLACES / REEMPLAZA:

Bosch: F 01R 00A 078

APPLICATION / APLICACIÓN:

MICRO: Panda L with CK 1.0 2008>2016

BOSCH

GC4139

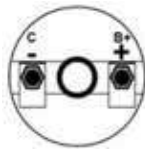

FEATURES / CARACTERÍSTICAS: OIL FUEL PUMP / WITHOUT IGNITION MODULE

REPLACES / REEMPLAZA:

Bosch: 9 220 081 039

VW: 305 905 119 A

APPLICATION / APLICACIÓN:

VW: Brasilia 1.6, Fusca 1.3/1.5/1.6, Gol 1.3/1.6, Kombi, Passat 1.5/1.6, Saveiro 1.6, Variant, Voyage 1.5/1.6 (All models Gasoline)

GURGEL: Xavante X12 1.6 1975>1993

BOSCH

GC4142

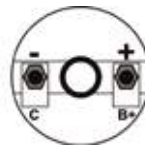

FEATURES / CARACTERÍSTICAS: ASPHALT COIL - 2 TERMINALS / WITHOUT IGNITION MODULE

REPLACES / REEMPLAZA:

Bosch: 9 220 081 054; **Fiat:** 7507442, 4360771

APPLICATION / APLICACIÓN:

FIAT: 147 1300 /Fiorino /Pick-Up /City 01.73>04.88, Rallye 01.73>12.86, Elba 1.3 10.85>11.89, Fiorino 1.3 Furgão /Pick-Up 05.88>11.93, Oggi 1050 01.73>11.81, 1300 10.77>05.83, 1500 06.84>08.85, Panorama 03.80>05.83 /01.73>08.85 /1.3 01.73>11.86, Premio 1.3 03.85>09.92 / 03.85>12.88, 1.5 10.85>07.88, Spazio 1.3 01.73>08.84, Uno 1050 06.84>08.85 /1.3 06.84>09.91;

FORD: Belina 1.3 01.68>12.72 /1.4 01.73>12.77, Belina II 1.6 01.79>12.89, Corcel 1.3 01.68>12.72, 1.4 01.73>12.77, Corcel II 1.4 01.78>12.78 /1.6 01.79>06.83;

VW: Brasilia 1.3 10.73>12.82 /1.6 10.73>12.82, Fusca 1300 01.80>12.80 /1500 10.70>10.75 /1600 01.69>10.83, Puma GTE-GTS 01.70>12.79, Karmann Ghia 1600 01.70>12.72, Kombi 1.3 11.80>11.81, Passat 1.5 07.74>07.82 /1.6 06.81>12.83, Variant 12.69>12.77, Variant II 01.78>12.81, Voyage 1.5 06.81>12.83

BOSCH
GC4143
FEATURES / CARACTERÍSTICAS: ASPHALT COIL - 4 TERMINALS / WITHOUT IGNITION MODULE

REPLACES / REEMPLAZA:
Bosch: 9 220 081 067; **Ford:** 542 905115, 84AU 12024 A, 305 905115 5; **GM:** 94 623 322; **VW:** 305 905 119 B; **Standard:** UF2

APPLICATION / APLICACIÓN:

FIAT: 147 1300 /Firoino /Pick-Up 83> 06.88, Oggi 1300 06.83>12.86, Panorama 06.83>12.86, Spazio 1.3 06.83>12.86;
FORD: Belina II 1.8 11.89>12.91, Corcel II 1.6 07.83>12.87, Del Rey 1.6 07.83>12.89 /1.8 08.89>12.91, Escort 1.3 08.83>08.92 /1.6 03.83>11.92 /1.8 06.89>11.92, F 1000 3.6 04.92>11.95, Pampa 1.6 /4X4 07.83>12.93, Royale 2.0i 02.92>08.93, Verona 1.6 01.90>11.92 /1.8 01.90>09.93, Versailles 2.0i 03.91>08.93;
GURGEL: BR 800 02.89>12.91;
GM: C20 03.92>10.95, Caravan 2.5 06.81>12.92 /4.1 10.74>12.92 /4.1S 10.84>12.89, Chevette /Hatch 1.4 06.74>08.87, 1.6 /S 08.82>12.89, Chevy 500 1.6 /S 08.82>12.89, Ipanema 1.8 08.89>02.91 /2.0 05.89>12.91 /Kadett 1.8 05.89>02.91 /GS 2.0 05.89>12.91, Marajo 1.4 74>08.87 /1.6 /S 08.82>12.89, Monza 1.6 /Hatch 01.84>12.86 /1.8 /Hatch 01.84>12.91 /2.0 /Hatch 10.86>12.91, Opala 2.5 01.71>12.92 /4.1 /S 01.71>12.92;
VW: Apollo 1.8 04.90>11.92, Fusca 1300 06.81>12.86 /1600 06.81>12.86, Gol 1.6 07.85>10.89 /1.8 02.84>08, Kombi 1.6 01.84>10.91, Parati I 1.6 12.82>08.86, Passat 1.6 01.84>06.89 /1.8 01.84>06.89, Quantum 1.8 09.85>08.87 /2.0 09.85>08.87, Santana 1.8 02.84>08.87,

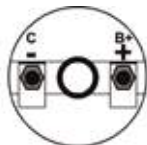
BOSCH
GC4177
FEATURES / CARACTERÍSTICAS: OIL FUEL PUMP / WITHOUT IGNITION MODULE

REPLACES / REEMPLAZA:
Bosch: 9 220 081 077
VW: 305 905 119 D, 325 905105 1

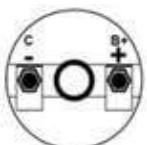
APPLICATION / APLICACIÓN:
VW: Gol 1.6 1990>1991, Gol 2.0 1988>1991, Saveiro 1.6 1990>1991, Quantum 1.8/2.0 1986>1994, Senda 1.6/1.8 1989>1997

BMW
GC4464
FEATURES / CARACTERÍSTICAS: 3 PIN / WITHOUT IGNITION MODULE

REPLACES / REEMPLAZA:
Bosch: 0221504464; **TRANSCO:** CUF055; **MOBILETRON:** CE-50; **REGITAR:** RUF515; **MEAT & DORIA:** 10351/10381

APPLICATION / APLICACIÓN:

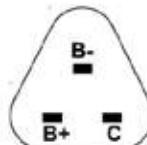
BMW: 325 Ci Coupe 2002>2006, 325i 2002>2005, 330 Ci Cabrio 2002>2006, 330i 2002>2005, M3 Coupe 2000>2006, 525i 2002>2005, 530i 2002>2005, 545i 2003>2005, 550i 2005>2010, 645 Ci 2004>2005, 650i 2005>2010, 650i Cabrio 2005>2010, 745i 2001>2005, X3 3.0 i 2004>2006, X5 3.0 i 2002>2006, X5 4.4 i 2003>2006, X5 4.8 i 2006>2008, X5 xDrive 48 i 2008>2010, Z4 3.0 i 2002>2005, Z8 2000>2003;
ROLLS ROYCE: Phantom 6.8 2003>, Phantom 6.8 Drophead 2007>;
ALPINA: 7-Series B7 Saloon 4.4 03>08

CHRYSLER
GC4040
FEATURES / CARACTERÍSTICAS: 3 PIN / WITHOUT IGNITION MODULE

REPLACES / REEMPLAZA:
Chrysler: 5269670, 04609103, 56032521, 56032521AB; **Standard:** UF189

APPLICATION / APLICACIÓN:

CHRYSLER: Cirrus, Neon (PL), Neon II, PT Cruiser, Voyager III (GS);
DODGE: Caravan, Caravan (RG_);
JEEP: Cherokee (KJ);
MINI: Mini (R50, R53), Mini Cabriolet (R52)

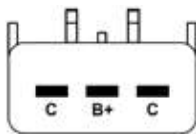
CHRYSLER
GC4041
FEATURES / CARACTERÍSTICAS: 3 PIN / WITHOUT IGNITION MODULE

REPLACES / REEMPLAZA:
Chrysler: 5296670, MS296670

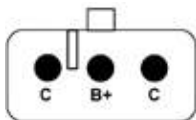
APPLICATION / APLICACIÓN:
CHRYSLER: Neon (PL) 94>00, Voyager III (GS) 95>01, Sebring (JR) 00>07, Voyager IV (RG, RS) 99>08

CHRYSLER
GC4113 // NEW //
FEATURES / CARACTERÍSTICAS:
REPLACES / REEMPLAZA:
CHRYSLER: 4606 869AA, 4606 869AB, 4606 869AC; **DODGE:** 4606869AB, 4606869AC 4606869AD; **DELPHI:** GN10310, GN10310-11B1, GN10310-12B1; **MEAT & DORIA:** 10624; **MOBILETRON:** CC-36

APPLICATION / APLICACIÓN:
CHRYSLER: 300 C 2.7 2007>2012, 300 C 2.7 2004>2012, 300 C 3.5 2004>2012, 300 C Touring 2.7 2007>2010, 300 C Touring 2.7 2004>2010, 300 C Touring 3.5 2004>2010, 300 C Touring 3.5 Awd 2004>2010, Sebring Conversivel 2.7 2007>2010;

DODGE: Avenger 2.7 2007>2011, Avenger 2.7 Flex-Fuel 2007>2009, Journey 3.5 2008>, Journey 3.5 Awd 2008>, Nitro 3.7 V6 4WD 2007>2012, Nitro 3.7 2006>2012, Nitro 4.0 4WD 2006>2011;

FIAT: Freemont 3.6 2011>, Freemont 3.6 4X4 2011>

CHRYSLER
GC4138
FEATURES / CARACTERÍSTICAS: 2 PIN / WITHOUT IGNITION MODULE

REPLACES / REEMPLAZA:
Chrysler: 56028138, 56028138-AD/AF/AB; **Standard:** UF270, UF297; **Wells:** C1231; **Mobiletron:** CC-31; **Regitar:** RUF270

APPLICATION / APLICACIÓN:
Chrysler: Aspen;

Dodge: Dakota, Durango, Nitro, Ram 1500;

Jeep: Commander, Grand Cherokee, Liberty;

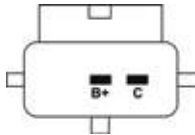
Mitsubishi: Raider.

CHRYSLER
GC4312
FEATURES / CARACTERÍSTICAS: 2 PIN / WITHOUT IGNITION MODULE

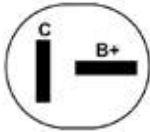
REPLACES / REEMPLAZA:
Chrysler: 4762312

APPLICATION / APLICACIÓN:
JEOP: Cherokee (XJ) 83>01, Grand Cherokee I 91>99, Wrangler II 96>08

CHRYSLER
GC4423
FEATURES / CARACTERÍSTICAS: 2 PIN / WITHOUT IGNITION MODULE

REPLACES / REEMPLAZA:
Chrysler: 4751253, 5234210, 5234610, 5252577, 4797293, 90048-52091-000; **GM:** 19017110; **Delco:** C506; **Lucas:** DMB968;

Standard: UF97; **Mobiletron:** CC-09; **Regitar:** RUF97

APPLICATION / APLICACIÓN:
Chrysler: Daytona, Dynasty, Lebaron, Grand Cherokee V8;

Plymouth: Acclaim, Sundance, Grand Voyage, Trucks;

Dodge: Trucks;

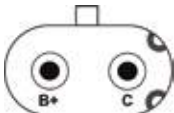
Jeep: Wrangler (6 Cilindros), Stratus

CHRYSLER
GC4503 // NEW //
FEATURES / CARACTERÍSTICAS:
REPLACES / REEMPLAZA:
Chrysler: DLB705; **HONDA:** 30500PM5A02, 30500PM5A03; **ROVER:** GCL161; **STARK:** SKCO-0070269

APPLICATION / APLICACIÓN:
HONDA: Civic Ii Shuttle 1.5 I 16V 1988>1991, Civic Ii Shuttle 1.6 I 16V 4Wd 1988>1995, Civic Iii Hatchback 1.5 GI 1983>1987, Civic Iii Sedan 1.5 GI 1983>1987, Civic Iii Sedan 1.5 Gti 1986>1987, Civic Iv Hatchback 1.5 I 16V 1988>1991, Civic Iv Hatchback 1.6 I 16V 1987>1991, Civic Iv Hatchback 1.6 I 16V Vtec 1989>1991, Civic Iv Sedan 1.5 I 16V 1987>1991, Civic Iv Sedan 1.6 I 16V 1987>1991, Civic Iv Sedan 1.6 I 16V 4X4 1989>1991, Civic V Hatchback 1.5 I 16V 1991>1995, Civic V Sedan 1.5 I 16V 1991>1995, Concerto 1.5 I 16V 1989>1995, Concerto 1.6 I 16V 1989>1995, Crx Ii 1.6 I 16V 1987>1992, Crx Ii 1.6 I 16V Vtec 1989>1992 **ROVER:** 200 Conversivel 216 1.6I 1992>1999, 200 Conversivel 216 1.6I 16V 1996>1999, 200 Coupé 216 1992>1999, 200 Hatch 216 Gsi 1990>1995, 200 Hatch 216 Gti 1990>1995, 400 416 Gsi 1990>1995, 400 416 Gti 1990>1995, 400 Tourer 1.6 I 1994>1998

CHRYSLER
GC4971
FEATURES / CARACTERÍSTICAS: 4 PIN / WITHOUT IGNITION MODULE

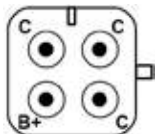
REPLACES / REEMPLAZA:
Chrysler: 4443971, 88921253

APPLICATION / APLICACIÓN:
Chrysler: Voyager I 84>90, Voyager II 90>95, Voyager III (GS) 95>01

CITROËN
GC4095
FEATURES / CARACTERÍSTICAS: 4 PIN / WITHOUT IGNITION MODULE

REPLACES / REEMPLAZA:
Valeo: 245095; **Citroën:** 597080, 597099, 9636337880, 96363378, 0040102045, 5DA749475-461; **Mobiletron:** CE-67; **Magneti Marelli:** BAEQ082; **Regitar:** RCE67

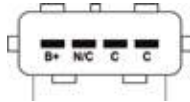
APPLICATION / APLICACIÓN:
CITROËN: C3 1.6 16V, Xsara, Xsara Break, Xsara Picasso 1.6 16V 02>;
PEUGEOT: 206, 307 1.6 16V

CITROËN
GC4774
FEATURES / CARACTERÍSTICAS: 4 PIN / WITHOUT IGNITION MODULE

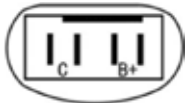
REPLACES / REEMPLAZA:
Citroën/Peugeot: 597042, 97531206; **MEAT&DORIA:** 10475; **MOBILETRON:** CE-20; **REGITAR:** RCE20;
Transpo: CUF309

APPLICATION / APLICACIÓN:
CITROËN: BX hatch 15/16/19/19 GTI 1987>1993, BX estate 15/16/19 1983>1994, C15 Van 1.1 1984>1996
PEUGEOT: 309 Mk1 hatch 1.1/1.3/1.6/1.9 1985>1989, 309 Mk2 hatch 1.6/1.9GTI 1989>1993, 405 Mk1 Saloon/Estate 1.6/1.9 1987>1992, 405 Mk2 Saloon 1.6 1992>1995

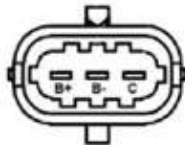
CITROËN/PEUGEOT
GC4458
FEATURES / CARACTERÍSTICAS: 3 PIN / WITHOUT IGNITION MODULE

REPLACES / REEMPLAZA:
Citroën/Peugeot: 9671214580; **Transpo:** CUF2169; **Bremi:** 20563; **Meat & Doria:** 10766; **NGK:** 49097; **Mobiletron:** CE-183;
Regitar: RCE183

APPLICATION / APLICACIÓN:
CITROËN: C-Elysée 1.2 2012>2014, C1 II 1.2 2014>, C3 II 1.0/1.2 2012>, C3 III 1.2 2016>, C4 Cactus 1.2 2014>, DS3 1.2 2013>2015
PEUGEOT: 108 1.2 2014>, 208 1.0/1.2 2012>, 301 1.2 2012>, 308 II 1.2 2013>, 2008 2013>

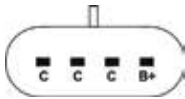
DAEWOO
GC4578
FEATURES / CARACTERÍSTICAS: 4 PIN / WITHOUT IGNITION MODULE

REPLACES / REEMPLAZA:
Daewoo: 96291054; **OEM:** 51578; **CSA:** 96291054; **Mobiletron:** CG-35

APPLICATION / APLICACIÓN:
CHEVROLET: Matiz 0.8 03.2005>, Spark 0.8 2005>2013, CMV (Van);
DAEWOO: Matiz 0.8 1998>2005, Damas (Van)

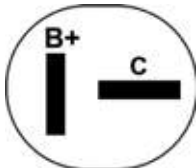
DAEWOO
GC4579
FEATURES / CARACTERÍSTICAS: 2 PIN / WITHOUT IGNITION MODULE

REPLACES / REEMPLAZA:
Daewoo: 33410A60B30-000, Y3C, 94582699; **Mobiletron:** CK01; **Regitar:** RCK01

APPLICATION / APLICACIÓN:
Daewoo: Tico

DAIHATSU
GC4334
FEATURES / CARACTERÍSTICAS: 2 PIN / WITHOUT IGNITION MODULE / WITH RESISTOR

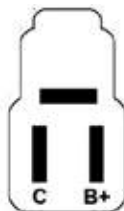
REPLACES / REEMPLAZA:
Daihatsu: 90048-52110;

Mobiletron: CH-14

APPLICATION / APLICACIÓN:
DAIHATSU: MIRA MK 3 HATCH 0.8 1990>1995, FERROZA SPORTRACK 1.6 16V 1988>1999, HIJET MK2 VAN 1.3 i 16V 1998, CHARADE MK4 HATCH 1.3 16V / 1.6 Gti 1993>1999, APPLAUSE MK1 / MK2 1.6 16V 1989>1997

DAIHATSU
GC4405 // NEW //

FEATURES / CARACTERÍSTICAS:
REPLACES / REEMPLAZA:
Daihatsu: 90048-52109; **CADIC:** KD-2505; **JMP:** 1405-52102; **DIAMOND:** F714

APPLICATION / APLICACIÓN:
DAIHATSU: Applause Mk1 1.6 16V 1989>1997, Applause Mk2 1.6 16V 1997>2000, Cuore Mk4 hatch 0.8 1995>1998, Feroza Sportrack soft top 1.6 16V 1988>1999, Feroza Sportrack hard top 1.6 16V 1988>1999, Move 0.8 1997>1999

DAIHATSU
GC4450

FEATURES / CARACTERÍSTICAS: 2 PIN / WITHOUT IGNITION MODULE / WITH RESISTOR

REPLACES / REEMPLAZA:
Daihatsu: 90048-52110;

Mobiletron: CH-14

APPLICATION / APLICACIÓN:
DAIHATSU: MIRA MK 3 HATCH 0.8 1990>1995, FEROZA SPORTRACK 1.6 16V 1988>1999, HIJET MK2 VAN 1.3 i 16V 1998, CHARADE MK4 HATCH 1.3 16V / 1.6 Gti 1993>1999, APPLAUSE MK1 / MK2 1.6 16V 1989>1997

DELPHI
GC4158 // NEW //

FEATURES / CARACTERÍSTICAS: 1 PIN

REPLACES / REEMPLAZA:
Mercedes-Benz: A 000 158 71 03, A 000 158 75 03, A 000 158 70 03, A 000 150 02 80; **VW:** 00A 905 115, 00A 905 105; **Delphi:** CE20038-12B1; **NGK:** 48018; **Bremi:** 20509; **Era:** 880180; **Cargo:** 150424; **Meat & Doria:** 10369; **Mobiletron:** CE-57

APPLICATION / APLICACIÓN:
DAEWOO: Korando (Kj) 2.3 1999>, Korando (Kj) 3.2 4X4 1999>, Korando Cabrio (Kj) 2.0 16V 1999>, Korando Cabrio (Kj) 2.3 1999>, Musso (Fj) 2.3 1999>, Musso (Fj) 3.2 4X4 1999>;

MERCEDES BENZ: 124 Coupé (C124) 320 Ce (124.052) 1992>1993, 124 Sedan (W124) 280 E (124.028) 1992>1993, 124 Sedan (W124) 280 E (124.028) 1992>1993, 124 Sedan (W124) 320 E (124.032) 1992>1993, 124 T-Model (S124) 280 Te (124.088) 1992>1993, 124 T-Model (S124) 280 Te (124.088) 1992>1993, 124 T-Model (S124) 320 Te (124.092) 1992>1993, 124 T-Model (S124) 320 Te (124.092) 1992>1993, C-Class (W202) C 180 (202.018) 1994>2000, C-Class (W202) C 180 (202.018) 1993>2000, C-Class (W202) C 200 (202.020) 1994>2000, C-Class (W202) C 200 Kompressor (202.025) 1995>2000, C-Class (W202) C 200 Kompressor (202.025) 1996>2000, C-Class (W202) C 220 (202.022) 1993>2000, C-Class (W202) C 230 (202.023) 1996>1997, C-Class (W202) C 230 Kompressor (202.024) 1995>2000, C-Class (W202) C 280 (202.028) 1993>2000, C-Class (W202) C 36 Amg (202.028) 1994>2000, C-Class T-Model (S202) C 180 T (202.078) 1996>2000, C-Class T-Model (S202) C 200 T Kompressor (202.082) 1996>2001, C-Class T-Model (S202) C 230 T (202.083) 1996>1998, C-Class T-Model (S202) C 230 T Kompressor (202.085) 1997>2000, Clk (C208) 200 (208.335) 1997>2002, Clk (C208) 200 Kompressor (208.345) 1997>2000, Clk (C208) 230 Kompressor (208.347) 1997>2000, Clk Conversível (A208) 200 (208.435) 1998>2002, Clk Conversível (A208) 200 Kompressor (208.445) 1998>2000, Clk Conversível (A208) 230 Kompressor (208.447) 1998>2000, E-Class (W124) E 280 (124.028) 1993>1995, E-Class (W124) E 280 (124.028) 1993>1995, E-Class (W124) E 280 (124.029) 1993>1995, E-Class (W124) E 320 (124.032) 1993>1995, E-Class (W124) E 36 Amg 1994>1995, E-Class (W210) E 200 (210.035) 1995>2000, E-Class (W210) E 200 Kompressor (210.045) 1997>2002, E-Class (W210) E 230 (210.037) 1995>1997, E-Class (W210) E 280 (210.053) 1996>1997, E-Class (W210) E 320 (210.055) 1995>1997, E-Class Conversível (A124) E 220 (124.062) 1993>1998, E-Class Conversível (A124) E 320 (124.066) 1993>1998, E-Class Conversível (A124) E 36 Amg (124.066) 1994>1998, E-Class Coupé (C124) E 36 Amg (124.052) 1994>1997, E-Class T-Model (S124) E 280 T (124.088) 1993>1996, E-Class T-Model (S124) E 280 T (124.088) 1993>1996, E-Class T-Model (S124) E 280 T (124.088) 1993>1996, E-Class T-Model (S124) E 320 T (124.092) 1993>1996, E-Class T-Model (S124) E 36 T Amg (124.092) 1994>1996, E-Class T-Model (S210) E 200 T (210.235) 1996>2000, E-Class T-Model (S210) E 200 T Kompressor (210.245) 1997>2003, E-Class T-Model (S210) E 230 T (210.237) 1996>1997, G-Class (W463) G 320 (463.230, 463.231) 1994>1997, G-Class (W463) G 36 Amg (463.230) 1995>1998, G-Class Cabrio (W463) 320 Ge (463.208) 1994>1997, M-Class (W163) Ml 230 (163.136) 1998>2005, S-Class (W140) 300 Se 2.8 (140.028) 1993>1998, S-Class (W140) 300 Se, Sel/S320 (140.032, 140.033) 1991>1998, S-Class (W140) S 280 (140.028) 1993>1998, Si (R129) 280 (129.058) 1993>2001, Si (R129) 320 (129.063) 1993>2001, Silk (R170) 200 (170.435) 1996>2000, Silk (R170) 200 Kompressor (170.445) 1996>2000, Silk (R170) 230 Kompressor (170.447) 1996>2000, Sprinter 2-T Truck Platform/Chassis (901, 902) 214 (902.011, 902.012, 902.611, 902.612) 1995>2006, Sprinter 2-T Truck Platform/Chassis (901, 902) 214 Ngt 1995>2006, Sprinter 2-T Furgão (901, 902) 214 1995>2006, Sprinter 2-T Furgão (901, 902) 214 Ngt 1995>2006, Sprinter 2-T Van Passenger (901, 902) 214 (902.071, 902.072, 902.671, 902.672) 1995>2006, Sprinter 2-T Van Passenger (901, 902) 214 Ngt 1995>2006, Sprinter 3-T Truck Platform/Chassis (903) 314 (903.011, 903.012, 903.013, 903.022, 903.611,...) 1995>2006, Sprinter 3-T Truck Platform/Chassis (903) 314 4X4 2002>2006, Sprinter 3-T Truck Platform/Chassis (903) 314 Ngt (903.611, 903.612) 1995>2006, Sprinter 3-T Furgão (903) 314 (903.071, 903.072, 903.073, 903.671, 903.672,...) 1995>2006, Sprinter 3-T Van Passenger (903) 314 4X4 2002>2006, Sprinter 3-T Van Passenger (903) 314 Ngt 1995>2006, Sprinter 4-T Truck Platform/Chassis (904) 414 (904.012, 904.013, 904.612, 904.613) 1997>2006, Sprinter 4-T Truck Platform/Chassis (904) 414 Ngt 1995>2006, Sprinter 4-T Furgão (904) 414 (904.062, 904.063, 904.662, 904.663) 1996>2006, Sprinter 4-T Furgão (904) 414 4X4 (904.062, 904.063, 904.662, 904.663) 1997>2006, Sprinter 4-T Furgão (904) 414 Ngt 1995>2006, Sprinter 4-T Van Passenger (904) 414 1996>2006, V-Class (638/2) V 200 (638.214, 638.294) 1997>2003, V-Class (638/2) V 230 (638.234, 638.294) 1996>2003, Vito Furgão (638) 113 2.0 (638.014, 638.094) 1997>2003, Vito Furgão (638) 114 2.3 (638.034, 638.094) 1997>2003, Vito Van Passenger (638) 113 2.0 (638.114, 638.194) 1996>2003, Vito Van Passenger (638) 114 2.3 (638.134, 638.194) 1996>2003;

VW: Lt 28-35 li Van Passenger (2Db, 2De, 2Dk) 2.3 1996>2006, Lt 28-46 li Truck Platform/Chassis (2Dc, 2Df, 2Dg, 2.2.3 1996>2006, Lt 28-46 li Furgão (2Da, 2Dd, 2Dh) 2.3 1996>2006

DELPHI
GC4267 // NEW //
FEATURES / CARACTERÍSTICAS:
REPLACES / REEMPLAZA:
DELPHI: GN10235; **MERCEDES-BENZ:** A 270 906 00 60, 000 150 19 80, 000 150 27 80, 000 150 26 80; **CHRYSLER:** 68011844AA, 6813 9957AA; **GM:** 19005267; **BREMI:** 20551; **MEAT & DORIA:** 10600

APPLICATION / APLICACIÓN:
MERCEDES-BENZ: C-KLASSE C230/C280/C350 2005>2007, C-KLASSE T-Model C230/C280/C350 2005>2007, C-KLASSE Sportcoupe C 230/350 2005>2008, CLC-KLASSE CLC 230/350 2008>2011, C-KLASSE T-Model C 230/280/350 2007>2014, C-KLASSE Coupe C 350 2011, CLK 280/350/500 2005>2009, CLK Cabriolet CLK 280/350/500 2005>2010, CLS CLS 280/300/350/500 2008>2010, E-KLASSE E230/280/350/500, E-KLASSE T-Model E 230/280/350/ T 350 CGI E500 T 2005>2009, E-KLASSE Coupe E 300/350/500 2010>2014, E-KLASSE Cabriolet CL 500 / 4 -MATIC 2006>2013, S-KLASSE S280/300/350/400/450/500 2006>2013, S-KLASSE Coupe CL500/ 4-TEMATIC 2006>2013, SL 280/300/350/500 2008>2012, M-KLASSE ML 350/ 500 4-MATIC 2005>2011, R-KLASSE R280/300/350/500 2007>2014, G-KLASSE G500 2008, G-KLASSE Cabrio G 500 2009, GL-KLASSE GL-450 4-MATIC 2006>2012, GLK-KLASSE 280/300/350 4-MATIC 2008>2015, VIANO 3.5 2007, VITO Bus 126 2007, VITO / MIXTO Kasten 126 2007, SPRINTER 3-t Bus 224 2006>2013, SPRINTER 3-t Kasten 224 2006>2013, SPRINTER 3-t Pritsche/Fahrgestell 224 2006>2013, SPRINTER 4,6-t Kasten 324 2006>2013, SPRINTER 4,6-t Pritsche/Fahrgestell 424 2006>2013, SPRINTER 5-t Kasten 524 2006>2013, SPRINTER 5-t Pritsche/Fahrgestell 524 2006>2013

DELPHI
GC4293
FEATURES / CARACTERÍSTICAS: WITHOUT IGNITION MODULE
REPLACES / REEMPLAZA:
Delphi: 19005293, GN10210; **Magneti Marelli:** B10044MM; **Bosch:** 0 221 504 464; **BMW:** 12 13 1 712 219, 12 13 7 551 260

APPLICATION / APLICACIÓN:
BMW: 114i/116i/118i/120i 10>, 316i/320i 11>;

CITROËN: C4 Hatch/C4 Coupe 1.6 THP 140/150 08>11, C4 II 1.6 THP 155 09>, C4 Picasso MPV 1.6 THP 140/155/1.6 16V 07>13, C4 Picasso II/C4 Grand Picasso II 1.6 THP 155/165 13>, C4 Grand Picasso MPV 1.6 16V/1.6 THP 155 06>, C5 MK 3 Hatch/Estate 1.6 THP 150/155 08>, DS3 1.6 THP 150/155/1.6 Racing 09>15, DS3 Convertible 1.6 THP 150/155 13>15, DS4/DS5 1.6 THP 155/160/165/200 11>15;

MINI: Convertible/ Roadster/ Mk2 Clubman/ Coupe Cooper/ Cooper S/ John Cooper Works/ John Cooper Works GP 05>, Countryman/ Paceman Cooper ALL4/ Cooper S ALL4/ Cooper S/ John Cooper Works ALL4 10>

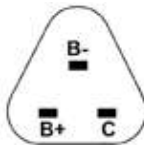
PEUGEOT: 207 Hatch/CC Convertible/SW Estate 1.6 16V Turbo/1.6 16V RC 06>, 208 1.6/1.6 GTi 12>, 308 Hatch/SW Estate 1.6 16V/1.6 GTi 07>, 308 CC Convertible 1.6 16V/1.6 THP 09>, 308 II/SW II 1.6/1.6 THP 125/150/163/1.6 GT 205/1.6 GTi 13>, 508/508 SW 1.6/1.6 THP 10>, 3008 1.6 THP/1.6 Turbo 09>, 5008 1.6/1.6 16V/1.6 THP 150 09>, RCZ 1.6 16V 10>

DELPHI
GC4307 // NEW //
FEATURES / CARACTERÍSTICAS: 2 PIN / WITHOUT IGNITION MODULE
REPLACES / REEMPLAZA:
Delphi: GN10307-12B1; **Kia:** 0K247-18-100A; **Transpo:** CUF253; **Mobiletron:** CK-07; **Meat & Doria:** 10446; **ERA:** 880186; **Bremi:** 20315; **Beru:** ZS433

APPLICATION / APLICACIÓN:
KIA: Carens Mk1 1.8i 2000>2002, Carens Mk2 1.6/1.8 2002>, Clarus saloon 1.8 i 16V 1996>2001, Clarus estate 1.8 i 16V 1998>, Mentor hatch/saloon 1.6i / 1.8i 16V 1995>1997, Shuma Mk1 hatch 1.8i 16V 1997>2001, Shuma Mk2 hatch 1.6/1.8 2001>2004, Shuma Mk2 saloon 1.6 2001>2004

DELPHI
GC4369 // NEW //
FEATURES / CARACTERÍSTICAS:
REPLACES / REEMPLAZA:
DELPHI: GN10369, GN10369-11B1, GN10369-12B1; **HONDA:** 30520-R40-007; **MOBILETRON:** CH-30

APPLICATION / APLICACIÓN:
Acura: ILX 2.4L 2013>2015

DELPHI
GC4457 // NEW //
FEATURES / CARACTERÍSTICAS: 2 PIN
REPLACES / REEMPLAZA:
Chrysler: 05149199AA, 5149199AA; **Dodge:** 68320417AA; **Delphi:** GN10457; **Bremi:** 20566

APPLICATION / APLICACIÓN:
DODGE: NITRO 3.7 2007>2012;

JEEP: CHEROKEE 3.7 2007>2015, COMMANDER 3.7 2005>2010

DELPHI
GC4690 // NEW //
FEATURES / CARACTERÍSTICAS: 4 PIN
REPLACES / REEMPLAZA:
MERCEDES-BENZ: A 274 906 06 00, A 274 906 14 00, 274 906 06 00, 274 906 1 4 00; **DELPHI:** GN10690, 28165252; **MEAT & DORIA:** 10816E

APPLICATION / APLICACIÓN:
INFINITI: Q30/Q50 2.0 T 2015, Q60 Coupe 2.0 T 2016, QX30 2.0 AWD 2016 **MERCEDES-BENZ:** A-CLASS 2014>2018, B-CLASS 2012>2018, C-CLASS 2008>2014, C-CLASS Convertible 2013>2018, C-CLASS Coupe 2012>2018, C-CLASS T-Model 2012>2014, CLA Coupe 2013>2019, CLA Shooting Brake 2015>2019, E-CLASS 2013>2018, E-CLASS Convertible 2013>2016, E-CLASS Coupe 2013>2016, E-CLASS T-Model 2012>2016, GLA-CLASS 2015>2019, GLC 2015>2019, GLC Coupe 2016>2019, GLK-CLASS 2013>2015, SLC 2015, SLK (R172) 2014, V-CLASS (W447) 2014, VITO Box (W447) 2015, VITO Tourer (W447) 2016

DELPHI

GC4880 // NEW //

FEATURES / CARACTERÍSTICAS:

REPLACES / REEMPLAZA:

MERCEDES-BENZ: 000 150 17 80; **BOSCH:** 0986221007; **DELPHI:** GN10604; **ERA:** 880240; **MEAT & DORIA:** 10341; **MOBILETRON:** CE-91; **TRANPO:** CUF044

APPLICATION / APLICACIÓN:

MERCEDES BENZ: C-Class (W203) C 180 2000>2002, C-Class (W203) C 200 Kompressor 2000>2002, C-Class Sportcoupe (CI203) C 180 2001>2002, C-Class Sportcoupe (CI203) C 200 Kompressor 2001>2002, C-Class Sportcoupe (CI203) C 230 Kompressor 2001>2002, C-Class T-Model (S202) C 180 T 2000>2001, C-Class T-Model (S202) C 200 T Kompressor 2000>2001, C-Class T-Model (S203) C 180 2001>2002, C-Class T-Model (S203) C 200 Kompressor 2001>2002, Clk (C208) 200 Kompressor 2000>2002, Clk (C208) 230 Kompressor 2000>2002, Clk Conversível (A208) 200 Kompressor 2000>2002, Clk Conversível (A208) 230 Kompressor 2000>2002, E-Class (W210) E 200 Kompressor 2000>2002, E-Class T-Model (S210) E 200 T Kompressor 2000>2003, Slk (R170) 200 Kompressor 2000>2004, Slk (R170) 230 Kompressor 2000>2004



DELPHI

GC4913

FEATURES / CARACTERÍSTICAS: 3 PIN / WITH IGNITION MODULE

REPLACES / REEMPLAZA:

Delphi: 28063913, 19005277; **JAC:** PHC28063913, 1A14, 120421; **Regitar:** RUF561

APPLICATION / APLICACIÓN:

JAC: J2, J3, J5 1.4/1.5

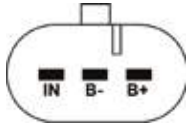

DELPHI

GC4980 // NEW //

FEATURES / CARACTERÍSTICAS: 3 PIN

REPLACES / REEMPLAZA:

MERCEDES BENZ: A 000 150 15 80, A 000 150 29 80, 000 150 15 80, 000 150 29 80; **BOSCH:** 098622A201, 0986221040; **VALEO:** 245725; **NGK:** 48131; **DELPHI:** GN10451-12B1; **ERA:** 880453A; **CARGO:** 150625; **MEAT & DORIA:** 10456; **MOBILETRON:** CE-186; **TRANPO:** CUF039

APPLICATION / APLICACIÓN:

MERCEDES BENZ: C-Class (W203) C 180 Kompressor 2000>2002, C-Class (W203) C 200 Cgi Kompressor 2000>2002, C-Class (W203) C 200 Kompressor 2001>2002, C-Class (W203) C 230 Kompressor 2001>2002, C-Class Sportcoupe (CI203) C 160 Kompressor 2000>2001, C-Class Sportcoupe (CI203) C 180 Kompressor 2000>2001, C-Class Sportcoupe (CI203) C 200 Cgi Kompressor 2001>2002, C-Class Sportcoupe (CI203) C 200 Kompressor 2001>2002, C-Class Sportcoupe (CI203) C 220 2000>2002, C-Class Sportcoupe (CI203) C 230 Kompressor 2000>2002, C-Class Sportcoupe (CI203) C 230 Kompressor 2000>2002, C-Class T-Model (S203) C 180 Kompressor 2000>2002, C-Class T-Model (S203) C 200 Cgi Kompressor 2000>2002, C-Class T-Model (S203) C 200 Kompressor 2000>2003, C-Class T-Model (S203) C 230 Kompressor 2000>2004, Clk (C209) 200 Cgi 2000>2004, Clk (C209) 200 Kompressor 2000>2005, Clk (C209) 200 Kompressor 2000>2006, Clk Conversível (A209) Clk 200 Kompressor 2000>2007, Clk Conversível (A209) Clk 200 Kompressor 2000>2008, E-Class (W211) E 200 Kompressor 2000>2009, E-Class (W211) E 200 Kompressor 2000>2010, E-Class (W211) E 200 Ngt 2000>2011, E-Class T-Model (S211) E 200 Kompressor 2000>2012, E-Class T-Model (S211) E 200 T Kompressor 2000>2013, Slk (R171) 200 Kompressor 2000>2014



DELPHI

GC4038

FEATURES / CARACTERÍSTICAS: 4 PIN / WITH IGNITION MODULE

REPLACES / REEMPLAZA:

Delphi: DF20013; **GM:** 01104038, 10450424, 10490192; **Magneti Marelli:** BI0013MM, BAEQ054; **Mobiletron:** CG-21; **Standard:** UF356; **Regitar:** RDR45R; **Transpo:** CUF356

APPLICATION / APLICACIÓN:

GM: Corsa 1.0/1.4/1.6

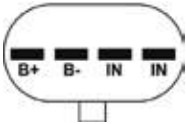

DELPHI

GC4133

FEATURES / CARACTERÍSTICAS: 6 PIN / WITHOUT IGNITION MODULE

REPLACES / REEMPLAZA:

Fiat: FTP 55228006, 55200112, 55200486; **Delphi:** CE20132, 28143176; **Bosch:** 0 986 221 065

APPLICATION / APLICACIÓN:

Fiat: Uno Vivace 1.4

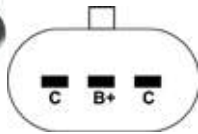

DELPHI
GC4373

FEATURES / CARACTERÍSTICAS: 3 PIN / WITHOUT IGNITION MODULE

REPLACES / REEMPLAZA:
Effa: GDQ170; **Delphi:** 19005270; **Mobiletron:** CG-23; **Regitar:** RCG23

APPLICATION / APLICACIÓN:
HAFEI: Minyi Minz, Chana, Changhe, Shuanghuan CEO, Tianma pickup, Geely Meiri CK Emgrand EC7 View Engran SC7, Hafei Minyi, Chevrolet Spark, Great Wall Haval, Lifan 520; **Geely** 4G15 engine, DA465, B12.

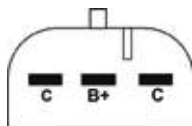
ASIA MOTORS: Towner EFFA

DELPHI
GC4483

FEATURES / CARACTERÍSTICAS: 3 PIN / WITHOUT IGNITION MODULE

REPLACES / REEMPLAZA:
Daewoo/GM: 93 363 483, 96 253 555; **Delphi:** CE10001; **Opel:** 19005265; **Mobiletron:** CG-24; **Magneti Marelli:** BAEQ089; **Standard:** UF503; **Regitar:** RDR45C

APPLICATION / APLICACIÓN:
GM: Aveo Hatchback 1.4 16v 2003>2008, Aveo Hatch 1.2/1.4 2008>, Aveo Saloon 1.2/1.4 2005>, Aveo Hatchback (T300) 1.4/1.6 2011>, Aveo Saloon (T300) 1.4/1.6 2011>, Captiva 2.0/2.4 2006>, Cruze 1.4/1.6 2009>, Cruze Hatchback 1.4/1.6 2011>, Cruze Station Wagon 1.4/1.6 2012>, Epica 2.0 2005>, Evanda 2.0 2005>, Lacetti 1.4/1.6/2.0 2005>, Matiz 1.0 2005>, Nubira Saloon 1.4/1.6/2.0 2005>2011, Nubira Estate 1.6/2.0 2005>2011, Tacuma 1.6/2.0 2005>, Matiz 1.0 SX 2005>, Spark 1.2 2010>, Trax 1.6 2012>;

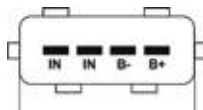
FIAT: Stilo, Palio, Siena, Idea, Dobló, Strada, Punto 1.8 8V.

DELPHI
GC4905

FEATURES / CARACTERÍSTICAS: 4 PIN / WITH IGNITION MODULE

REPLACES / REEMPLAZA:
Opel: 1208063; **Delphi:** BID 00001; **Magneti Marelli:** BI0012MM, BAEQ046; **GM:** 1103905, 10457075; **Bosch:** F000ZS9200; **Mobiletron:** CG-16; **Standard:** DR44; **Regitar:** RDR44

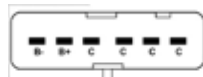
APPLICATION / APLICACIÓN:
GM: Blazer, Corsa, S10

DELPHI
GC4085 // NEW //

FEATURES / CARACTERÍSTICAS: 6 PIN

REPLACES / REEMPLAZA:
DELPHI: GN10239-12B1; **PEUGEOT/CITROËN:** 5970.85, 9651710680; **NGK:** 48124; **MOBILETRON:** CE108; **REGITAR:** RCE108; **MEAT & DORIA:** 10464

APPLICATION / APLICACIÓN:
PEUGEOT: 206 hatch 1.4 16v 2003->, 206 SW estate 1.4 16v 2003->, 207 hatch 1.4 16v 2006->, 307 hatch 1.4 16v 2003->, 307 estate 1.4 16v 2003>2007, 307 SW estate 1.4 16v 2003>2007, 1007 1.4 16v 2005->

CITROËN: C2 1.4 16v 2006->, C3 1.4 16v 2003->, C4 hatch 1.4 16v 2004>2011, C4 coupe 1.4 16v 2004>2011

DELPHI
GC4927

FEATURES / CARACTERÍSTICAS: 7 PIN / LONG BOOT / WITH IGNITION MODULE

REPLACES / REEMPLAZA:
GM: 55584404, 96476983; **Opel:** 1208098; **Delphi:** 28326927; **Airtex:** 5C1703; **Carquest:** 522058; **Standard:** UF620; **Wells:** C1646; **Mobiletron:** CE-161; **Regitar:** RCE161

APPLICATION / APLICACIÓN:
GM: Cruze 1.8 2011>, Sonic 1.6 16V 2013, Aveo L4-1.6L 2009>2011, Aveo5 L4-1.6L 2009>2011; **OPEL:** Astra GTC J 1.8 103Kw 140CV 796cc, Astra H Caravan 1.6 85Kw 116CV 1598cc, Astra J 1.6 85Kw 115CV 1598cc, Astra J Stufenheck 1.6 85Kw 116CV 1598cc, Astra Sports Tourer (J) 1.6 85Kw 116CV 1598cc /1.6 LPG 84Kw 114CV 1598cc, Insignia 1.6 85Kw 116CV 1598cc /1.8 103Kw 140CV 1796cc, Insignia Sports Tourer 1.6 85Kw 116CV 1598cc /1.8 103Kw 140CV 1796cc, Insignia tufenheck 1.6 85Kw 116CV 1598cc /1.8 103Kw 140CV 1796cc, Mokka 1.6 85Kw 116CV 1598cc, Zafira B (A05) 1.8 103Kw 140CV 1796cc, Zafira B Van 1.8 103Kw 140CV 1796cc, Zafira C (P12) 1.8 103Kw 140CV 1796cc /1.8 LPG 101Kw 137CV 1796cc;

PONTIAC: G3 L4-1.6L 2009>2010, G3 Wave L4-1.6L 2009

DELPHI
GC4931 // NEW //
FEATURES / CARACTERÍSTICAS: 4 PIN / WITHOUT IGNITION MODULE

REPLACES / REEMPLAZA:
Delphi: CE20015-12B1; **Dacia:** 6000592931, 6001544755; **Meat & Doria:** 10421

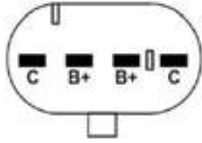
APPLICATION / APLICACIÓN:
DACIA: Logan Saloon 1.4 2004>2006, Logan MCV Estate 1.4 2007>, Logan Express 1.4 2009>, Logan Pick-up 1.4 2009>

DENSO
GC4080
FEATURES / CARACTERÍSTICAS: 4 PIN / WITH IGNITION MODULE

REPLACES / REEMPLAZA:
Denso: 90080-19023, 90919-02243, 90919-02244, 90919-02266; **Transpo:** CUF333

APPLICATION / APLICACIÓN:
TOYOTA: Avensis Verso MPV 2.0 VVT-i 2001>2009, Avensis Mk2 Hatch/Saloon/Estate 2.0/2.4 2003>2008, Camry Saloon 2.4 2001>2006, Previa Mk2 2.4 2000>2006, RAV 4 Mk2 2.0 VVT-i 4WD 2000>2005, RAV 4 Mk3 2.0 VVT-i 4WD 2006->, RAV 4 Mk3 2.4 VVT-i 2005->, Picnic 2.0 2001, Land Cruiser 4.0 2003>2009

DENSO
GC4101
FEATURES / CARACTERÍSTICAS: 3 PIN / WITH IGNITION MODULE

REPLACES / REEMPLAZA:
Denso: 099700-101; **Honda:** 30520-RNA-A01; **Standard:** UF582; **Mobiletron:** CH-29; **Regitar:** RUF582;

Magneti Marelli: BI0088MM; **Delphi:** GN10324; **Transpo:** CUF582

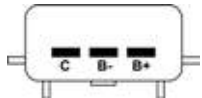
APPLICATION / APLICACIÓN:
Honda: New Civic 06>

DENSO
GC4107 // NEW //
FEATURES / CARACTERÍSTICAS: WITH IGNITION MODULE

REPLACES / REEMPLAZA:
Denso: DIC-0105; **Honda:** 30520-PNA-007, 30520-RAA-007, 30520-RRA-007; **Mobiletron:** CH-25; **Regitar:** RUF311;

Meat & Doria: 10563; **Bremi:** 20400; **NGK:** 48295; **Transpo:** CUF2897; **Era:** 880258; **Cargo:** 150630

APPLICATION / APLICACIÓN:
HONDA: Accord Mk8 saloon/estate 2.0/2.4 2003>2008, Civic Mk6/Mk7 hatch 2.0 2001>2005, CRV Mk2 SUV 2.0 2001>2007, CRV Mk3 SUV 2.0 2007>, FR-V 2.0 2005>, Integra Type-R Mk2 coupe 2.0 2002>, Stream MPV 2.0 16v 2001>

DENSO
GC4126
FEATURES / CARACTERÍSTICAS: 3 PIN / WITH IGNITION MODULE

REPLACES / REEMPLAZA:
Daihatsu: 90048-52126, 90048-52125; **Denso:** 099700-0570; **MEAT&DORIA:** 10711; **Mobiletron:** CT-22; **Regitar:** RCT22;

Transpo: CUF0407

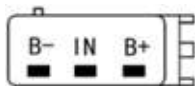
APPLICATION / APLICACIÓN:
Daihatsu: Cuore Mk6 1.0 1998>2003, Move 1.0 1998>2002, Sirion Mk1 hatch 1.0 1998>2000

DENSO
GC4151
FEATURES / CARACTERÍSTICAS: 4 PIN / WITH IGNITION MODULE

REPLACES / REEMPLAZA:
Denso: 099700-1510; **Magneti Marelli:** BI0107MM; **CHEVROLET:** 12590990, 12610626, 12618542, 12632479; **SUZUKI:** 33400-78J00, 33400-78J01, 33400-78J02, 33400-78J03; **BREMI:** 20520; **MOBILETRON:** CC-34; **NGK:** 49072; **TRANSPPO:** CUF569;

WELLS: C1555

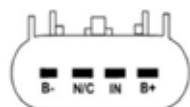
APPLICATION / APLICACIÓN:
GM: Camaro 3.6 2011>2015, Camaro convertible 3.6 2011>, Captiva 3.0/3.2 2006>;

SUZUKI: Grand Vitara Mk2 3.2 2009>2015

DENSO
GC4181
FEATURES / CARACTERÍSTICAS: 3 PIN / WITH IGNITION MODULE

REPLACES / REEMPLAZA:
Denso: 099700-181, 099700181

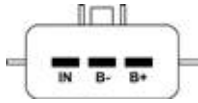
APPLICATION / APLICACIÓN:
Honda: New Civic

DENSO
GC4239
FEATURES / CARACTERÍSTICAS: 4 PIN / WITH IGNITION MODULE

REPLACES / REEMPLAZA:
Denso: 90919-02239, 90919-02262; **Bosch:** F005X11783; **Magneti Marelli:** BAE Q126, BI0051MM; **Valeo:** 245178; **Delphi:** GN10314; **Mobiletron:** CT-25; **Standard:** UF247; **Regitar:** RUF247; **Transpo:** CUF247

APPLICATION / APLICACIÓN:
TOYOTA: Corolla 1.6i 16V Sedan gas 02-09/ 1.8i 16V Sedan Flex 2008>/ 1.8i 16V Sedan gas 02-08, Fielder 1.8i 16V Wagon gas 04-07.

DENSO
GC4251
FEATURES / CARACTERÍSTICAS: 4 PIN / WITH IGNITION MODULE

REPLACES / REEMPLAZA:
TOYOTA: 90919-A2002, 90919-A2004, 90919-A2007, 90919-02251, 90919-0225; **MEAT & DORIA:** 10617; **MOBILETRON:** CT-40, CT-54; **TRANSPO:** CUF487; **NGK:** U5076, 48257

APPLICATION / APLICACIÓN:
LEXUS: RX 350 450h AWD 2008>2015, RX Mk2 350 AWD 2006>2008, GS 450h 2012>

TOYOTA: Land Cruiser 200 4.6 V8 2012

DENSO
GC4252
FEATURES / CARACTERÍSTICAS: 4 PIN / WITH IGNITION MODULE

REPLACES / REEMPLAZA:
Toyota / Denso: 90919-02252, 90919-02258, 90919-C2003, 90919-C2005; **Mobiletron:** CT-47; **Magneti Marelli:** BAE680CT, BI0114MM; **Standard:** UF596 / UF619; **Regitar:** RCT47; **Transpo:** CUF596

APPLICATION / APLICACIÓN:
Pontiac: Vibe; **Scion:** XD; **Toyota:** Corolla, Matrix, Prius.

Lexus: CT200H

DENSO
GC4263
FEATURES / CARACTERÍSTICAS: 3 PIN / WITH IGNITION MODULE

REPLACES / REEMPLAZA:
Denso: 90919-02263; **Magneti Marelli:** BI0103MM

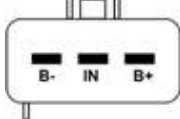
APPLICATION / APLICACIÓN:
TOYOTA: Etios 1.3 1.5 16 V Flex, Liva

DENSO
GC4273
FEATURES / CARACTERÍSTICAS: 2 PIN / WITHOUT IGNITION MODULE

REPLACES / REEMPLAZA:
Denso: 27301-2B000; **Mobiletron:** CK-33; **Regitar:** RCK33

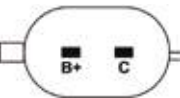
APPLICATION / APLICACIÓN:
HYUNDAI: i30 1.4 / 1.6 2007>2011;

KIA: Cerato 1.6 2004>, Soul 2009>

DENSO
GC4700
FEATURES / CARACTERÍSTICAS: 4 PIN / WITH IGNITION MODULE

REPLACES / REEMPLAZA:
DENSO: 099700-1070; **LAND ROVER:** LR002954; **VOLVO:** 306842450, 30684245; **TRANSPO:** CUF2431; **NGK:** 48399

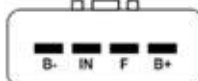
APPLICATION / APLICACIÓN:
LAND ROVER: Freelander Mk2 3.2 4x4 2006>2014

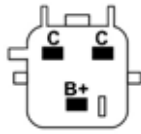
VOLVO: S60 II T6, S80 Mk2 Saloon 3.2 2006>2016, V60 T6 2010>2015, V70 Mk3 Estate 3.2 2007>2015, XC60 SUV 3.2 2009>2010, XC70 Mk2 Estate 3.2 2007->, XC90 SUV 3.2 2006>2010

DENSO
GC4180 // NEW //

FEATURES / CARACTERÍSTICAS: 3 PIN

REPLACES / REEMPLAZA:
DENSO: DIC-0114; **BOSCH:** 0 986 221 080; **HYUNDAI/ KIA:** 2730123900; **MAGNETI MARELLI:** BI0104MM; **DELPHI:** GN10416; **MEAT & DORIA:** 10597; **BREMI:** 20389; **BERU:** ZS541; **MOBILETRON:** CK-26; **REGITAR:** RUF593; **NGK:** 48370; **TRANSPO:** CUF593

APPLICATION / APLICACIÓN:
HYUNDAI: Coupe Mk2 2.0 2001>2009, Elantra Mk3 hatch/saloon 2.0 2000>2006, i30 hatch 2.0 2007>2011, i30 estate 2.0 2008>2012, Trajet 2.0 2004>2008, Tucson 2.0 2004>2010;

KIA: Carens Mk2 2.0 CVVT 2004->, Cee'd hatch/estate 2.0 2006>2012, Pro Cee'd hatch 2.0 2008>2012, Cerato saloon/hatch 2.0 2004->, Sportage Mk2 SUV 2.0i 16v 2004->

DENSO
GC4420

FEATURES / CARACTERÍSTICAS: 2 PIN / 2 COILS / WITHOUT IGNITION MODULE

REPLACES / REEMPLAZA:
Denso: 01122-0210; **Hyundai /KIA:** 27301-22600; **Standard:** UF308; **Wells:** C1350, MSW LT-C1350; **Mobiletron:** CK-05; **Magneti Marelli:** BAEQ110; **Regitar:** RUF308

APPLICATION / APLICACIÓN:
DODGE: Verna L4-1.6L 2004>2006;

HYUNDAI: Accent 1995>2003, Accent 2000>2003 L4-1.5L, Accent L4-1.6L 2003

DENSO
GC4710 // NEW //

FEATURES / CARACTERÍSTICAS:
REPLACES / REEMPLAZA:
Denso: DIC0111; **HYUNDAI/KIA:** 2730102700; **MOBILETRON:** CK37; **MEAT & DORIA:** 10459

APPLICATION / APLICACIÓN:
KIA: Picanto Mk1 1.0/1.1 2004>

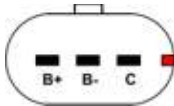
FIAT
GC4288

FEATURES / CARACTERÍSTICAS: 3 PIN / WITHOUT IGNITION MODULE

REPLACES / REEMPLAZA:
Fiat: 46777288; **Alfa Romeo:** 46777288; **Magneti Marelli:** BAE403C; **Lucas:** DMB861; **Bosch:** 0986221043

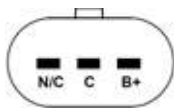
APPLICATION / APLICACIÓN:
FIAT: Bravo II, Doblo, Doblo Kasten/Kombi, Doblo Pritsche/Fahrgestell, Idea, Panda, Punto, Grand Punto, Stilo, Stilo Multi Wagon, Tipo Stufenheck, 500, 500 C, 500L

FIAT
GC4624

FEATURES / CARACTERÍSTICAS: 3 PIN / WITHOUT IGNITION MODULE

REPLACES / REEMPLAZA:
Fiat: 046 068 24AC; **Magneti Marelli:** BI0113MM

APPLICATION / APLICACIÓN:
CHRYSLER: Sebring 2.0 VVT 2006->2010, Sebring Convertible 2.4 VVT 07>10;

DODGE: Avanger 2.0/2.4 2007->, Caliber 1.8/2.0 2006->, Journey 2.4 2008>;

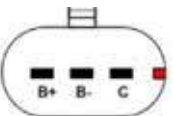
JEEP: Compass 2.0/2.4 4x4 2006->, Patriot 2.4 4x4 2007>

FIAT
GC4920

FEATURES / CARACTERÍSTICAS: 3 PIN / WITHOUT IGNITION MODULE

REPLACES / REEMPLAZA:
Fiat: 68070492AD; **MOBILETRON:** CE-208

APPLICATION / APLICACIÓN:
FIAT: 500 Multiair 1.4 2012>

FIAT
GC4998 // NEW //

FEATURES / CARACTERÍSTICAS: 3 PIN

REPLACES / REEMPLAZA:
Fiat: 55267998, 77690001

APPLICATION / APLICACIÓN:
FIAT: Argo, Cronos, Mobi, Palio 1.4 EVO Flex, Novo Uno 2016>

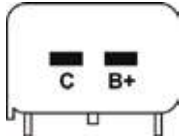
FORD
GC4016

FEATURES / CARACTERÍSTICAS: 2 PIN / WITHOUT IGNITION MODULE

REPLACES / REEMPLAZA:
Ford: F7TU-12A336-AB, 3W7E-12A366-AA, F7TZ-12029-AB, IL2U-12029-AA, IL2Z-12029-AA, F7TZ-12A366-BA, F7TZ-12029-BA, F7TZ-12029-CC, F7TZ-12029-CA, F7TZ-12A366-AB, 3W7Z-12029-AA DG508, DG491, DG467, DG472; **Mobiletron:** CF-30; **Standard:** FD503; **Regitar:** RFD503

APPLICATION / APLICACIÓN:
FORD: E-150, E-250, F-150, E-350 /F-250 /F-350 /F-450/F-550 Super Duty, Crown Victoria, Mustang, Expedition, Excursion, E-150 /E-250 /E-350 Econoline (98-2000);

LINCOLN: Town Car, Navigator (98-2000);

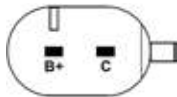
MERCURY: Grand Marquis (98-2000)

FORD
GC4066

FEATURES / CARACTERÍSTICAS: 2 PIN / WITHOUT IGNITION MODULE

REPLACES / REEMPLAZA:
Ford: E3BG-12A366-BB

APPLICATION / APLICACIÓN:
FORD: New Ka 1.0 2015>

FORD
GC4100 // NEW //

FEATURES / CARACTERÍSTICAS:
REPLACES / REEMPLAZA:
Ford: 1120169, 1252407, 1331283, 1362718, 1673468, 6M21-12029-AA, YM21-12029 AD, YM21-12029-AA, YM21-12029-AB, YM21-12029-AC; **Beru:** ZSE063

APPLICATION / APLICACIÓN:
FORD: Galaxy 2.8 V6 2000>2006;

SEAT: Alhambra 2.8 V6 2000>2010, Alhambra 2.8 V6 4Motion 2000>2010, Toledo II 2.3 V5 20V 2000>2003;

VW: Bora 2.3 V5 2000>2005, Bora 2.3 V5 4Motion 2000>2005, Bora 2.8 V6 4Motion 1999>2005, Bora Variant 2.3 V5 2000>2005, Bora Variant 2.3 V5 4Motion 2000>2005, Bora Variant 2.8 V6 4Motion 1999>2005, Golf IV 2.3 V5 2000>2005, Golf IV 2.3 V5 4Motion 2000>2005, Golf IV 2.8 V6 4Motion 1999>2005, Golf IV Variant 2.3 V5 2000>2006, Golf IV Variant 2.3 V5 4Motion 2000>2006, Golf IV Variant 2.8 V6 4Motion 1999>2006, New Beetle 2.3 V5 2000>2010, New Beetle Rsi 3.2 4Motion 2000>2001, Sharan 2.8 V6 24V 2000>2010, Sharan 2.8 V6 24V 4Motion 2000>2010

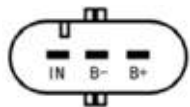
FORD
GC4123

FEATURES / CARACTERÍSTICAS: 3 PIN / WITH IGNITION MODULE

REPLACES / REEMPLAZA:
Ford: CM5G12A366CB; **MEAT & DORIA:** 10772; **BREMI:** 20674; **MOBILETRON:** CF-88

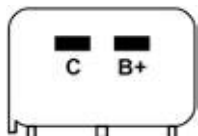
APPLICATION / APLICACIÓN:
FORD: B-Max 1.0 2012>, C-Max II 1.0 2012>, Grand C-Max 1.0 2012>, EcoSport 1.0 2013>, Fiesta Mk7 hatch 1.0 2012>, Focus III 1.0 2012>, Mondeo V Hatchback 1.0 2015>, Transit Courier kombi 1.0 2014>, Tourneo Connect 1.0 2013>

FORD
GC4366

FEATURES / CARACTERÍSTICAS: 2 PIN / WITHOUT IGNITION MODULE

REPLACES / REEMPLAZA:
Ford: 12A366-BA/B/C, 4W5G-12A366-BA, 4M5G-12A366-BB, 4M5G-12A366-BC, 4M5Z-12029B, 4M5Z-12029BC, 1224925, 1314271, LF16-18-100B; **Wells:** C1453; **Volvo:** 31375294; **Mobiletron:** CF-60; **Magneti Marelli:** BAEQ105, BI0108MM; **Standard:** FD505; **Regitar:** RFD505; **Bosch:** 0 221 504 702; **Transpo:** CFD505

APPLICATION / APLICACIÓN:
Ford: Focus 2.0 2003-2007, Ecosport 2.0 Duratec, Transit Connect, Escape;

Mazda: Tribute

Mercury: Mariner;

Volvo: C30 2.0 2006>, S40 II 1.8 04>10, V50 1.8 04>10, V50 2.0 06>12

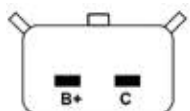
FORD
GC4375

FEATURES / CARACTERÍSTICAS: 2 PIN / WITHOUT IGNITION MODULE

REPLACES / REEMPLAZA:
Ford: 7T4E12A375EE, 7T4E12A375ED; **Mazda:** CY01-18-100, CY01-18-100A; **Motorcraft:** DG520; **Standard:** UF553; **Mobiletron:** CF-79; **Regitar:** RUF553

APPLICATION / APLICACIÓN:
Ford: Edge 3.5, 3.7 V6 07 >, Lincoln MKS 09, Lincoln KX 07>09, Lincoln MKZ 07>09, Taurus 08>09, Taurus X 07>09;

Mazda: 3.7L V6, 3.5L V6.

FORD

GC4452 // NEW //

FEATURES / CARACTERÍSTICAS: 2 PIN

REPLACES / REEMPLAZA:

Ford: 1L8E-12A366-AA, 1L8E-12A366-AB, 1L8E-12A366-AC, 1L8U-12A366-AA, 1L8Z-12029-AA, 1L8Z-12029-AB, 1L81-2A366-AA; **MAZDA:** AJC1-18100, AJ03-18100, AJ03-18100-A, AJ09-18100, AJ09-18100-A; **TRANSPO:** CFD502; **ERA:** 880294; **BREMI:** 20434; **MEAT & DORIA:** 10696; **NGK:** 48276; **BERU:** ZS410

APPLICATION / APLICACIÓN:

Mazda: Tribute 3.0 V6 24V 2000 FORD: Maverick Mk2 2.0/3.0 2001>>2008



FORD

GC4010

FEATURES / CARACTERÍSTICAS: 3 PIN / WITHOUT IGNITION MODULE

REPLACES / REEMPLAZA:

Mazda: L813-18-100; **Mobiletron:** CF-59; **Magneti Marelli:** BAEQ136; **Regitar:** RCF59

APPLICATION / APLICACIÓN:

Ford: Fiesta Mk IV / V, Fiesta Van, Escort Mk VII, Courier 1.3, Ka 1.3i, Street Ka, Mondeo Mk II / III, Puma, Cougar, Focus, Escape, Fusion; **Mazda:** Demio

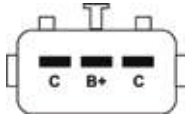

FORD

GC4030

FEATURES / CARACTERÍSTICAS: 3 PIN / WITHOUT IGNITION MODULE

REPLACES / REEMPLAZA:

Ford: 988F12029-BA, 988F12029-AC, 1S7Z12029-AD, 988F12029-AB, 988F12029-AD, 1067601, 1075786, 1130402, 1317972, 1319788, 1119835;

Delphi: CE20119;

Mazda: 1E04-18-10X, 1E05-18-100B, YF09-18-10X, 1F20-18-100, LF01-18-100;

Lucas: DMB805;

Magneti Marelli: BI0020MM, BAEQ038; **Mobiletron:** CF-46; **Standard:** FD497

APPLICATION / APLICACIÓN:

Ford: Fiesta, Ecosport, Courier, Escort, Focus, Ka, Mondeo, Kadett

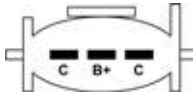

FORD

GC4031

FEATURES / CARACTERÍSTICAS: 3 PIN / WITHOUT IGNITION MODULE

REPLACES / REEMPLAZA:

Ford: CM5G-12029-FC; **Standard:** UF-155; **Wells:** C1040; **Mobiletron:** CF-81; **Magneti Marelli:** BI0100MM; **Delphi:** GN10449

APPLICATION / APLICACIÓN:

Ford: Ecosport, Fiesta, Focus, KA 1.6, Sigma

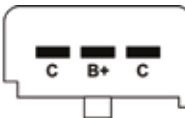

FORD

GC4044

FEATURES / CARACTERÍSTICAS: 4 PIN / WITHOUT IGNITION MODULE

REPLACES / REEMPLAZA:

Ford: 90TF12029A1A, F82U12029AA; **Magneti Marelli:** BI0050MM

APPLICATION / APLICACIÓN:

Ford: Explorer 90>94, Explorer 94>01, Mustang Coupé

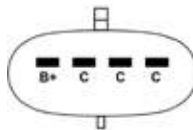

FORD

GC4114

FEATURES / CARACTERÍSTICAS: 4 PIN / WITHOUT IGNITION MODULE

REPLACES / REEMPLAZA:

Motorcraft: F5SU-12029-11, DG-440; **Ford:** 919F-12029-AA, E9SF-12029-AA, F5SU-12029-AA, E9SZ-12029-A, 19017114, F-509, 6630365, 6958305, 6489415; **Denso:** 0297006760, 0297007180; **Jaguar:** LNA 1508AA; **Lucas:** DMB752;

Mobiletron: CF-45; **Regitar:** RFD488

APPLICATION / APLICACIÓN:

Ford: 89>99, Mondeo 6CC 96>00;

Mercury: 89>90, 95>99

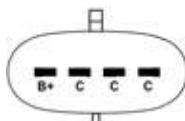

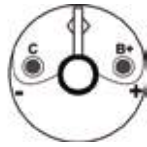
FORD
GC4140

FEATURES / CARACTERÍSTICAS: 2 PIN / OIL COIL / WITHOUT IGNITION MODULE

REPLACES / REEMPLAZA:
Ford: FD476, FD476T, FD476X, C832, 3230427, 33004522, 8933004522, D5AZ-1209-A, DG314, F502, F502Z, FO400, J3230427, 9224771015; **Wai:** CFD476; **Standard:** FD476

APPLICATION / APLICACIÓN:
FORD: Fairmont V6 1983, Thunderbird 1985>1989, Trucks F150 1985>1989, Truck&Vans 1975>1987;

MERCURY: 1975>1986, Cougar V-6 1985>1989, Topaz 1984>1989;

NISSAN: Tsuru II 1988>1992; **AMC:** 1977>1987, Eagle 1988;

JEEP: 1978>1991; **LINCOLN:** 1975>1984;

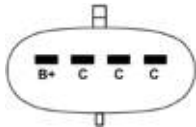
FORD
GC4775

FEATURES / CARACTERÍSTICAS: WITHOUT IGNITION MODULE

REPLACES / REEMPLAZA:
Bosch: 9 220 061 800; **Ford:** 94DA-12029AC; **Mobiletron:** CF-63

APPLICATION / APLICACIÓN:
Ford: Falcon EF and AU Series

FORD/MAZDA
GC4019

FEATURES / CARACTERÍSTICAS: 2 PIN / WITHOUT IGNITION MODULE

REPLACES / REEMPLAZA:
Ford: E1EF12029AA, E2FZ12029A, E3FZ12029A, E73F12029AA, AB, E73Z12029A, E32Z12029A, 12321405, 12336833, 19017194, F-503, F-1953, 1694979-C1, F-515-18-10X, ZZMI-18-100, ZZM4-18-100, F3FU 12029AA, E2EF 12029AA, E3EF 12029AA, F32Z-12029-A, FD478X, DG434, DG-325A, DG-325AD, DGE-453; **Mobiletron:** CF-01; **Standard:** FD478; **Regitar:** RFD478

APPLICATION / APLICACIÓN:
FORD: EXP 83-88, V6 3.0L 90-97, Taurus 86-95, Tempo 85-94;

MAZDA: 626 94-97, MX-6 94-97, pickup 94;

MERCURY: Capri 83-86, Colony Park 85-91

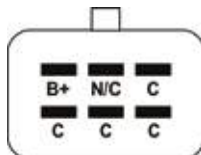
GM
GC4012

FEATURES / CARACTERÍSTICAS: 6 PIN / WITH IGNITION MODULE

REPLACES / REEMPLAZA:
OPEL: 1208307; **GM:** 1208307, 19 005 212; **Fiat:** 47.905.104; **Mobiletron:** CE-25; **Magneti Marelli:** BAEQ052, BI0057MM; **Standard:** UF687; **Regitar:** RCE25; **Bosch:** 0986221039; **Delphi:** CE10000

APPLICATION / APLICACIÓN:
FIAT: Stilo 1.8 16V;

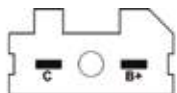
GM: Astra 1.6 16V, Meriva 1.8 16V

GM
GC4015

FEATURES / CARACTERÍSTICAS: 2 TERMINALS / WITHOUT IGNITION MODULE

REPLACES / REEMPLAZA:
GM: D539, D540, D555, 1103608, 1103646, 1103662, 1103663, 1103744, 1103745, 1103746, 10468391, 10472401, 10497771, 10495121; **Isuzu:** 8-10468-391-0; **Mobiletron:** CG-05; **Standard:** DR39; **Regitar:** RDR39

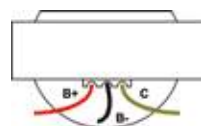
APPLICATION / APLICACIÓN:
GM: Omega Australiano 3.8 V6, S10 V6 Americana, Corvette 90-95, Impala 00-05, LLV (Postal vehicle) 94-95, S10 Pickup 94-03, Lumina 90-01, Lumina APV 92-96, Malibu/Malibu Maxx 97-03, Monte Carlo 95-05, Venture97-05, Oldsmobile Toronado 86-92

GM
GC4017

FEATURES / CARACTERÍSTICAS: 3 TERMINALS / WITHOUT IGNITION MODULE

REPLACES / REEMPLAZA:
GM: D530, D532, D523, 8131936, J8131936, 1875894, 1985473, 10497132, CONP12029A, DGG-419, 1694925-C1, IDO-4002S; **Mobiletron:** CG-01; **Standard:** DR31; **Regitar:** RDR31

APPLICATION / APLICACIÓN:
CHRYSLER / GM: American Motors Concord 80-81, Corvette 74-81, El Camino 74-87, Impala 74-85, Laguna 74-76, Astro 85, Fullsize Pickup 75-89, G Series Fullsizes Van /Express 75-88, P Series Van 75/89, Pontiac Parisienne 77-86, Pontiac Ventura 77

GM

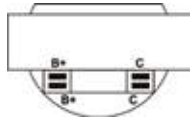
GC4021



FEATURES / CARACTERÍSTICAS: 4 TERMINALS / WITHOUT IGNITION MODULE

REPLACES / REEMPLAZA:

GM: D525, D527, D528, D529 1187847, 8134003, J8134003, 1115444, 1115445, 1115447, 1115449, 1115460, 1115448, 1115455, DGG-222 DGG-322, DGG-421, 5-73, 5-74; **Mobiletron**: CG-03; **Standard**: DR35; **Regitar**: RDR35

APPLICATION / APLICACIÓN:

GM TRUCK: 75-77, 82-84;
CHEVROLET TRUCK: 75-77, 82-84;
OLDSMOBILE: 75-77, 81-84

GM

GC4062

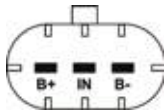

FEATURES / CARACTERÍSTICAS: 3 PIN / WITH IGNITION MODULE

REPLACES / REEMPLAZA:

GM: 12568062; **Standard**: UF303; **OEM**: 43420000; **Isuzu**: 8-12568-062-0

APPLICATION / APLICACIÓN:

BUICK: Rainier 2004>2005; **CHEVROLET**: Blazer 2002, Colorado 2004>2006, Trailblazer 2002>2005 /EXT 2002>2005; GMC: Canyon 2004>2006, Envoy 2002>2005 /XL 2002>2005 /XUV 2004>2005; **HUMMER**: H3 2006; **ISUZU**: Ascender 2003>2008, i-280 2006, i-290 2007>2008, i-350 2006, i-370 2007>2008; **OLDSMOBILE**: Bravada 2002>2004; **SAAB**: 9-7x 2005

GM

GC4092

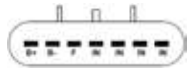

FEATURES / CARACTERÍSTICAS: 7 PIN / WITH IGNITION MODULE

REPLACES / REEMPLAZA:

Chevrolet/ Vauxhall/ GM: 55573735, 55577898, 55575499, 55579072; **OPEL**: 1208092, 1208093, 1208096; **DELPHI**: 19005362; **Mobiletron**: CE-168; **Regitar**: RUF669

APPLICATION / APLICACIÓN:

GM: Astra, Corsa 1.4, Cascada 1.4 Turbo;
OPEL: Adam, Astra, Cascada, Corsa, Insignia, Meriva, Mokka, Zafira;
CHEVROLET: Aveo, Cruze, Orlando, Trax, Volt.

GM

GC4141

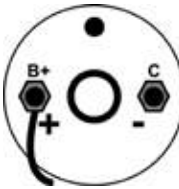

FEATURES / CARACTERÍSTICAS: COIL BY OIL - 2 PIN / WITH RESISTOR / WITHOUT IGNITION MODULE

REPLACES / REEMPLAZA:

C831, 90919-02111, DQ132, GT-63; **Valeo**: 245010; **Bougicord**: 155198; **Standard**: UC12 / UF2; **Hitachi**: C6R-800; **Mobiletron**: CJ-25

APPLICATION / APLICACIÓN:

Universal

GM

GC4192

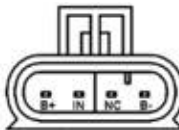

FEATURES / CARACTERÍSTICAS: 4 PIN / WITH IGNITION MODULE

REPLACES / REEMPLAZA:

GM: 12558948, 12556450

Standard: UF192

Wells: C1144

Mobiletron: CG-26

Regitar: RUF192

Transpo: CUF192

APPLICATION / APLICACIÓN:

CADILLAC: CTS 5.7 V8 2005>2007

CHEVROLET: Camaro 92 5.7 1992>2002, Corvette 5.7 1997>2004, Corvette Convertible 5.7 1997>2004

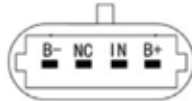
GM
GC4208

FEATURES / CARACTERÍSTICAS: 4 PIN / WITH IGNITION MODULE

REPLACES / REEMPLAZA:
Delco: BSC1208, 19279903

Chevrolet: 12556893, 12558693, 12570553

Wells: C1208

Standard: UF271

Mobiletron: CG-28

Regitar: RUF271

Transpo: CUF271

APPLICATION / APLICACIÓN:
CHEVROLET: Tahoe 4.8 V8 1999>2006, Tahoe 5.3 2000>2006, Tahoe 5.3 V8 AWD 1999>2006, Tahoe 5.3 AWD 2002>2006

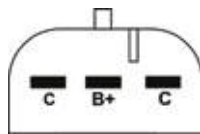
GM
GC4265

FEATURES / CARACTERÍSTICAS: 3 PIN / WITHOUT IGNITION MODULE

REPLACES / REEMPLAZA:
DELPHI: CE20130; **GM:** 94716808

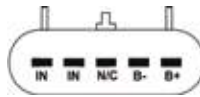
APPLICATION / APLICACIÓN:
GM: Celta /Corsa /Meriva /Montana /Prisma 8V flex

GM
GC4298

FEATURES / CARACTERÍSTICAS: 5 PIN / WITH IGNITION MODULE

REPLACES / REEMPLAZA:
DELPHI: CE20131; **GM:** 24580298QTY, 94702536; **Mobiletron:** CG-38; **Regitar:** RDR45F; **Magneti Marelli:** BI0067MM

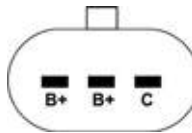
APPLICATION / APLICACIÓN:
GM: Agile 1.4/1.8, S10 2.4 Flex 2009>2012, Spin 1.4/1.8 All >2017, Montana 1.4 2012>

GM
GC4422

FEATURES / CARACTERÍSTICAS: 3 PIN / WITHOUT IGNITION MODULE

REPLACES / REEMPLAZA:
GM: D-577, 10489421; **Isuzu:** 8-10489-421-0; **Standard:** DR49; **Mobiletron:** CG-07; **Regitar:** RDR57; **Magneti Marelli:** BI0034MM

APPLICATION / APLICACIÓN:
GM: Blazer 4.3 V6, S10 4.3 V6;

Buick: Roadmaster;

Cadillac: Escalade, Fleetwood;

Chevrolet: Astro Van, Camaro, Caprice, Express Van, Pickup Truck, Tahoe;

GMC: Pickup Truck, Jimmy, Safari Van, Savana Van, Sonoma Pickup Truck, Yukon;

Isuzu: Hombre Pickup Truck;

Oldsmobile: Bravada;

Pontiac: Firebird

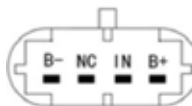
GM
GC4512

FEATURES / CARACTERÍSTICAS: 4 PIN / WITH IGNITION MODULE

REPLACES / REEMPLAZA:
AC Delco: BSC1512, 19279917

Chevrolet: 12573190

Wells: C1512

Standard: UF414

Mobiletron: CG-36

Regitar: RUF414

Transpo: CUF414

APPLICATION / APLICACIÓN:
CADILLAC: CTS 6.2 2009->, Escalade Pickup 6.2 Flex/Flex AWD 2010->, Escalade 6.0 Hybrid / 6.0 Hybrid AWD / 6.2AWD / 6.2 Flexfuel/ AWD 06>14

CHEVROLET: Avalanche 5.3 Flexfuel / Flexfuel AWD 2007->, Camaro 6.2 2009>2015, Camaro Convertible 6.2 2011->, Corvette 6.0/6.2/6.2 ZR1/Z06 7.0 2004->, Corvette Convertible 6.0 2004->, Silverado 1500 5.3 AWD/5.3 Flexfuel AWD 2007->, Tahoe 5.3/5.3 AWD 2002>2006

GMC: Yukon 6.2/6.2 4WD 2008>2014

GM

GC4547

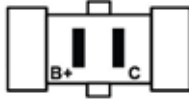

FEATURES / CARACTERÍSTICAS: 2 PIN / WITHOUT IGNITION MODULE

REPLACES / REEMPLAZA:

GM: 10457109, 10472748, 10474481, D547, D550, D583; **Standard:** DR41; **Mobiletron:** CG-06; **Regitar:** RDR41

APPLICATION / APLICACIÓN:

Chevrolet: Beretta, Cavalier;

Pontiac: Grand Am, Grand Prix, Sunfire, Tempest;

Buick: Skylark

GM

GC4916

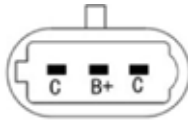

FEATURES / CARACTERÍSTICAS: 3 PIN / WITHOUT IGNITION MODULE

REPLACES / REEMPLAZA:

GM: 24531916

Bosch: F 01R 00A 027

APPLICATION / APLICACIÓN:

GM: N200, N300, N300P

GM

GC4672

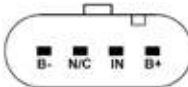

FEATURES / CARACTERÍSTICAS: 4 PIN / WITH IGNITION MODULE

REPLACES / REEMPLAZA:

GM: 12635672, 12670053, 12697989, 12698064; **MEAT & DORIA:** 10776

APPLICATION / APLICACIÓN:

OPEL: Adam/Corsa E 1.0 12>, Astra K/ Astra K Sports Tourer 1.0/1.4 Turbo 15>

GM

GC4781

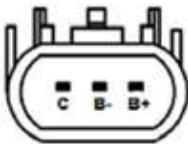

FEATURES / CARACTERÍSTICAS: 3 PIN / WITHOUT IGNITION MODULE

REPLACES / REEMPLAZA:

GM: 9023781; **BREMI:** 20615

APPLICATION / APLICACIÓN:

GM: Sail 1.5 2013>2015, Buick 1.5 2013>2015, New Cruze 1.5 2013>2015, Wuling Light 1.2/1.4/1.5 2008>2015

GM

GC4824

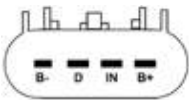

FEATURES / CARACTERÍSTICAS: 4 PIN / WITH IGNITION MODULE

REPLACES / REEMPLAZA:

GM: 12578224, 12638824; **Denso:** 099700-0850; **Wells:** C1552; **Standard:** UF491; **Mobiletron:** CG-33; **Regitar:** RUF491;

Magneti Marelli: BI0068MM

APPLICATION / APLICACIÓN:

Chevrolet: Captiva;

Buick;

Pontiac

GM

GC4539

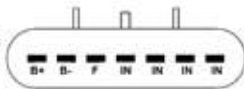

FEATURES / CARACTERÍSTICAS: 7 PIN / WITHOUT IGNITION MODULE

REPLACES / REEMPLAZA:

Chevrolet: 55585539; **Delphi:** CE01840-11B1, 28326925, 25186686; **Mobiletron:** CG-29; **Regitar:** RCG29

APPLICATION / APLICACIÓN:

Chevrolet: Cruze 1.6/ 1.8 2009>2015, Orlando 1.8 2011>2015, Aveo 1.4 Saloon 2005, Kalos 2005, Nubira Estate 2005

GM
GC4655
FEATURES / CARACTERÍSTICAS: 7 PIN / WITH IGNITION MODULE / SHORT BOOT

REPLACES / REEMPLAZA:
DELPHI: 19005358, GN10234-12B1; **GM:** 55561655, 96476983, 25186687; **OPEL:** 1208086; **VDO:** 5WK9397 13K11;

WELLS: C1646; **STANDARD:** UF620; **AC DELCO:** D517C; **LUCAS:** DB1104; **Mobiletron:** CE-163; **Regitar:** RCE163; **Magneti Marelli:** BI0074MM; **Bosch:** 0 986 221 098

APPLICATION / APLICACIÓN:
Chevrolet: Cruze 1.8 16V, Sonic 1.6, Aveo, Aveo5 2009-11, Pontiac G3, G3 Wave

GM
GC4745
FEATURES / CARACTERÍSTICAS: 7 PIN / WITH IGNITION MODULE

REPLACES / REEMPLAZA:
GM: 55571790, 26163171, 55584745;

Delphi: CE01841-11B1, 28326923; **Mobiletron:** CG-32; **Regitar:** RCG32

APPLICATION / APLICACIÓN:
GM: Aveo 2011>, Cruze 2009>, Trax 2012>;

OPEL: Astra H 2004>, Astra J 2009>, Mokka 2012>;

BUICK: 1.6 T/ 1.8 T

GM
GC4808
FEATURES / CARACTERÍSTICAS: 5 PIN / WITHOUT IGNITION MODULE

REPLACES / REEMPLAZA:
Opel: 1208008; **Mobiletron:** CE-55;

GM: 90536194, 9119567; **Valeo:** 2526116A; **Lucas:** DMB817;

Beru: 0040100342; **Regitar:** RDR590

APPLICATION / APLICACIÓN:
GM: Astra G 1.8i 16V 97>, Corsa 1.8i 16V 01>, Meriva 1.8i 16V 02>, Vectra 1.8i 16V 98>, Zafira 1.8i 16V 99>, Signum 2003>, Tigra 1.4/ 1.8

GM
GC4926
FEATURES / CARACTERÍSTICAS: 6 PIN / WITHOUT IGNITION MODULE

REPLACES / REEMPLAZA:
GM: 10458316, 1104082, 11004082; **Opel:** 1208021; **Delphi:** CE20009-12B1; **Fiat/Alfa Romeo:** 71739725, 71744369; **Lucas:** DMB939;

Mobiletron: CE-81; **Standard:** UF606; **Regitar:** RCE81

APPLICATION / APLICACIÓN:
Chery; Peugeot; Citroën; Opel

GM
GC4964 // NEW //
FEATURES / CARACTERÍSTICAS: 3 PIN / WITHOUT IGNITION MODULE

REPLACES / REEMPLAZA:
Chevrolet: 96415010; **Daewoo:** 96415010; **Mobiletron:** CK-28; **Regitar:** RCK28; **NGK:** 48318; **Meat & Doria:** 10630;

Bremi: 20448; **Beru:** ZS508

APPLICATION / APLICACIÓN:
CHEVROLET: Cruze 1.8 2009->, Lacetti 1.8 2005->, Nubira Saloon 1.8 2005->, Nubira Estate 1.8 2005->;

DAEWOO: Lacetti hatch 1.8 2004->, Nubira Saloon 1.8 2003->, Nubira Estate 1.8 2003->

GM
GC4979
FEATURES / CARACTERÍSTICAS: 7 PIN / WITHOUT IGNITION MODULE

REPLACES / REEMPLAZA:
Chevrolet: 55570160, 28125877;

GM: 25186686, 96476979; **Mobiletron:** CG-29; **Regitar:** RCG29

APPLICATION / APLICACIÓN:
GM: Cruze 1.6T, 1.8T 2009>, Hatchback 1.8 2010>, Astra 2008>

GM/DAEWOO/FORD
GC4020
FEATURES / CARACTERÍSTICAS: 4 TERMINALS / WITHOUT IGNITION MODULE

REPLACES / REEMPLAZA:
GM: D-535, D-537, D-544, D-560, D-573, D-575, DR37X, AF5FU12029AA, 1115315, 1115316, 1115317, 1115466, 1115467, 1115468, 1115491, 10477208, 8983501871, 83501871; **ISUZU:** 8-01115-315-0, 8-01115-466-0, 806673T, 817378T; **Mobiletron:** CG-04; **Magneti Marelli:** BAEQ080; **Standard:** DR37; **Regitar:** RDR37

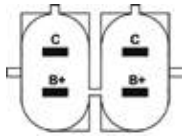
APPLICATION / APLICACIÓN:
GM /DAEWOO /FORD: Camaro, Caprice, Corvette, Storm, Impala, Fleetwood, Firebird, Cavalier 94~96, Skyhawk, Cimarron

HITACHI
GC4025
FEATURES / CARACTERÍSTICAS: 3 PIN / WITH IGNITION MODULE

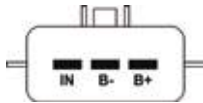
REPLACES / REEMPLAZA:
NISSAN 22448-4M500, 22448-4M50A; **HITACHI:** CM11-205; **MAZDA:** 1N10-18-100; **BERU:** 0040102021; **LUCAS:** DMB856; **BOSCH:** 0986JG1211; **Mobiletron:** CN-19; **Magneti Marelli:** BAEQ087; **Regitar:** RUF326; **Transpo:** CUF326

APPLICATION / APLICACIÓN:
NISSAN: Sentra /Primera 99~08, Almera 1.5-1.8 00>08

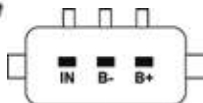
HITACHI
GC4108
FEATURES / CARACTERÍSTICAS: 3 PIN / BACK / WITH IGNITION MODULE

REPLACES / REEMPLAZA:
Hitachi: CM11-108; **Honda:** 30521-PWA-003; **Standard:** UF374; **Mobiletron:** CH-26; **Regitar:** RUF374; **Transpo:** CUF2894

APPLICATION / APLICACIÓN:
HONDA: Fit 1.4 8V 2004>2008

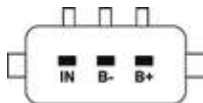
HITACHI
GC4109
FEATURES / CARACTERÍSTICAS: 3 PIN / FRONT / WITH IGNITION MODULE

REPLACES / REEMPLAZA:
Hitachi: CM11-109; **Honda:** 30520-PWA-003 /30520ERA201; **Standard:** UF373; **Mobiletron:** CH-27; **Regitar:** RUF373; **Magneti Marelli:** BI0028MM; **Transpo:** CUF2893

APPLICATION / APLICACIÓN:
HONDA: Fit 1.4 8V 2004>2008

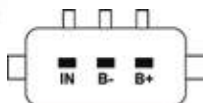
HITACHI
GC4110
FEATURES / CARACTERÍSTICAS: 3 PIN / 1 PART BY CYLINDER / WITH IGNITION MODULE

REPLACES / REEMPLAZA:
Hitachi: CM11-110, 5215C; **Honda:** 30520-PWC-003; **Standard:** UF581; **Magneti Marelli:** BI0029MM; **Mobiletron:** CH-24; **Regitar:** RUF581; **Transpo:** CUF581

APPLICATION / APLICACIÓN:
HONDA: Fit 1.5 16V 2009>

HITACHI
GC4111
FEATURES / CARACTERÍSTICAS: WITH IGNITION MODULE

REPLACES / REEMPLAZA:
Hitachi: CM11-116; **Magneti Marelli:** BI0075MM; **HONDA:** 30520-RB0-003, 30520-RB0-S01; **Transpo:** CUF626

APPLICATION / APLICACIÓN:
HONDA: Civic Mk7 Hatch 1.4 08>, CR-Z 1.5 Hybrid, Jazz III 1.2/1.3i/1.3 Hybrid 05>

HITACHI
GC4124 // NEW //
FEATURES / CARACTERÍSTICAS: 3 PIN

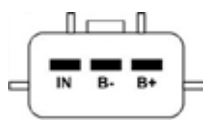
REPLACES / REEMPLAZA:
Hitachi: CM11-124A; **HONDA:** 30520-59B013

APPLICATION / APLICACIÓN:
HONDA: Civic Touring CVT 1.5 Turbo 2017>, Accord hybrid sedan 2017>2018 (touring), Accord Sedan 2018, Civic 5 door 2018, CR-V 2017>2018

HITACHI
GC4161 // NEW //
FEATURES / CARACTERÍSTICAS: 3 PIN / WITH IGNITION MODULE

REPLACES / REEMPLAZA:
Hitachi: 133909, AIC6207J, HEXEXA6207J; **Nissan:** 22448-AX000, 22448-AX001; **Beru:** ZSE188; **Bremi:** 20441; **Meat & Doria:** 10514; **Mobiletron:** CN-40; **NGK:** 48201; **Transpo:** CUF2809

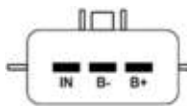
APPLICATION / APLICACIÓN:
NISSAN: Micra Mk3 1.0/1.2/1.4 16V 2003>2010, Micra C+C convertible 1.4 16V 2005->, Note 1.4 2006>2012

HITACHI
GC4202 // NEW //
FEATURES / CARACTERÍSTICAS: 3 PIN

REPLACES / REEMPLAZA:
Hitachi: CM11-202; **FIAT:** 46473849; **MEAT & DORIA:** 10301; **TRANSPO:** CUF037; **BREMI:** 20187; **ERA:** 880011; **MOBILETRON:** CE-159

APPLICATION / APLICACIÓN:
FIAT: Barchetta Cabrio 1.8 16V 1995>2005, Brava hatch 1.8 GT 16V 1995>2001, Bravo Mk1 hatch 1.8 GT 1995>2001, Coupe 1.8 16V 1996>2000, Marea Saloon 1.8 16V 1996>2002, Marea Weekend estate 1.8 16V 1996>2002, Punto Mk2 hatch 1.8 HGT 1999>2012, Stilo hatch/estate 1.8 16V 2001>2006;

LANCIA: Dedra 1.8 16V 1996>1999, Dedra SW 1.8 16V 1996>1999, Delta Mk2 hatch 1.8 1996>1999, Lybra 1.8 16V 1999>2005, Lybra SW 1.8 16V 1999>2005

HITACHI
GC4220 // NEW //
FEATURES / CARACTERÍSTICAS: 3 PIN / WITHOUT IGNITION MODULE

REPLACES / REEMPLAZA:
Bosch: 0 221 504 020; **Toyota:** 90080-19017, 90080-1901700; **Transpo:** CUF2819; **Mobiletron:** CT-28; **Regitar:** RCT28; **Meat & Doria:** 10413; **Beru:** ZS449; **Bremi:** 20314; **ERA:** 880175; **NGK:** 48116

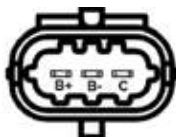
APPLICATION / APLICACIÓN:
TOYOTA: Corolla Hatch 1.4 2000>2002, Corolla saloon 1.4 16V 2000>2001, Corolla estate 1.4 16V 2000>2001

HITACHI
GC4325
FEATURES / CARACTERÍSTICAS: 3 PIN / WITH IGNITION MODULE

REPLACES / REEMPLAZA:
Hitachi: 8971363250, 8970745540, 88921373, CM11-102; **Mobiletron:** CJ-11; **Standard:** UF245; **Regitar:** RUF245

APPLICATION / APLICACIÓN:
ISUZU: D-MAX 3.5 turbo, Amigo, Rodeo, Trooper, Vehicross;

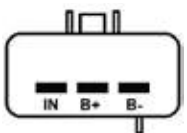
ACURA: SLX

HONDA: Passport

HITACHI
GC4871 // NEW //
FEATURES / CARACTERÍSTICAS: 2 PIN / WITHOUT IGNITION MODULE

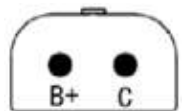
REPLACES / REEMPLAZA:
Hitachi: 133851, 2503851; **Volvo:** 1275971, 3531300, 9135689, 9146776; **Meat & Doria:** 10679; **Bremi:** 20374; **Transpo:** CUF167; **NGK:** 48237; **Mobiletron:** CE-128; **Regitar:** RUF167

APPLICATION / APLICACIÓN:
VOLVO: C70 convertible 2.4 1998>2005, S90 saloon 2.9 1997>1998, V90 estate 2.9 1997>1998, 940 saloon 2.0 turbo 1990>1994, 960 saloon/estate 2.9 1990>1994, 960 Mk2 saloon/estate 2.5/2.9 1994>1996

HITACHI
GC4466 // NEW //
FEATURES / CARACTERÍSTICAS: 4 PIN / WITH IGNITION MODULE

REPLACES / REEMPLAZA:
Hitachi: 133896; **Jaguar:** C2S11480, C2S42673, C2S7928, XR822478; **Mobiletron:** CF-72; **Meat & Doria:** 10609; **ERA:** 880452; **Bremi:** 20500; **Transpo:** CUF2444; **NGK:** 48268

APPLICATION / APLICACIÓN:
JAGUAR: S-Type 2.5/3.0 V6 1999>2007, XF 3.0 2008>2015, XJ 3.0 2003>2009, X-type saloon/estate 2.1/2.5/2.0 V6 2001>2009

HITACHI
GC4537 // NEW //
FEATURES / CARACTERÍSTICAS: 4 PIN / WITH IGNITION MODULE

REPLACES / REEMPLAZA:
Hitachi: 134038; **Toyota/ Lexus:** 90919-A2003, 90919-A2005, 90919-C2004, 90919-02250, 90919-02256, 90919-02257; **Transpo:** CUF2446; **Meat & Doria:** 10561, 10659; **Bremi:** 20637; **Mobiletron:** CT-45; **NGK:** 48269; **Era:** 880242

APPLICATION / APLICACIÓN:
TOYOTA: Land Cruiser 200 4.6 V8 2012>, Urban Cruiser 1.33 2009>2016, Verso S 1.33 2010>2016, Yaris Mk2 hatch 1.33 VVT-i 2008>2011, Yaris 1.3 2011>

LEXUS: GS Mk3 300/450h 2005>2011, GS 250/300h/450h 2012>, IS Mk2 250 2005>2013, LS Mk4 460/600h 2006>

SUBARU: Trezia 1.3 2011>

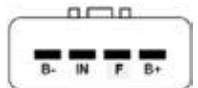
DAIHATSU: Charade 1.33 16V 2011>

HITACHI
GC4582 // NEW //

FEATURES / CARACTERÍSTICAS: 3 PIN

REPLACES / REEMPLAZA:
Hitachi: CM14301; **Fiat:** 46460582, 60606485; **NGK:** 48102; **Transpo:** CUF2729; **Mobiletron:** CE-137; **Meat & Doria:** 10334; **Beru:** ZS549; **Bremi:** 20412; **Era:** 880010

APPLICATION / APLICACIÓN:
FIAT: Barchetta Cabrio 1.8 16V 1995>2005, Brava hatch 1.8 GT 16V 1995>2001, Coupe 1.8 16V 1996>2000, Marea Saloon 1.8 115 16V 1996>2002, Marea Weekend Estate 1.8 115 16V 1996>2002;

LANCIA: Dedra 1.8 16V 1996>1999, Dedra SW 1.8 16V 1996>1999, Delta MK2 hatch 1.8 16V 1996>1999

HITACHI
GC4078 // NEW //

FEATURES / CARACTERÍSTICAS: 4 PIN / WITHOUT IGNITION MODULE

REPLACES / REEMPLAZA:
Hitachi: 138765; **Renault:** 7700872449, 7700872834, 8200141149; **Mobiletron:** CE41, CE73; **Regitar:** RCE41, RCE73; **Meat & Doria:** 10379; **Bremi:** 11719; **Beru:** ZS345

APPLICATION / APLICACIÓN:
RENAULT: Clio Mk1 hatch 1.2 1996>1998, Clio Mk2 hatch 1.2 /2.0 16v 1998>2009, Kangoo Mk1 1.2 2001>2007, Kangoo Mk1 Van 1.2 1997>20001, Laguna Mk2 hatch/estate 2.0 16v 2001>, Megane Mk1 Coupe 2.0i 1999>2003, Megane convertible 2.0 16v 1999>2003, Twingo Mk1 hatch 1.2 1996>2007

HITACHI
GC4209 // NEW //

FEATURES / CARACTERÍSTICAS: 4 PIN / WITHOUT IGNITION MODULE

REPLACES / REEMPLAZA:
Hitachi: 133896; **Jaguar:** C2S11480, C2S42673, C2S7928, XR822478; **Mobiletron:** CF-72; **Meat & Doria:** 10609; **ERA:** 880452; **Bremi:** 20500; **Transpo:** CUF2444; **NGK:** 48268

APPLICATION / APLICACIÓN:
JAGUAR: S-Type 2.5/3.0 V6 1999>2007, XF 3.0 2008>2015, XJ 3.0 2003>2009, X-type saloon/ estate 2.1/2.5/2.0 V6 2001>2009

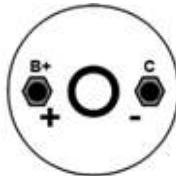
HITACHI
GC4211 // NEW //

FEATURES / CARACTERÍSTICAS: WITHOUT IGNITION MODULE

REPLACES / REEMPLAZA:
Hitachi: C1T-118; **Elecman:** TC-121

APPLICATION / APLICACIÓN:
CHEVROLET: Luv 1981>1982; **FORD:** Festiva 1988;

HONDA: Civic 1984>1985, Prelude 1979>1982;

ISUZU: I-mark 1981>1984, Pickup 1981>1987, Trooper 1984>1985;

MAZDA: 323 1986>1987, 626 1983>1989, B2000 1986>1987, B2200 1987>1992, MX-6 1988>1989, RX-7 1981>1985;

NISSAN: 200SX 1981, 310 1982, 510 1981, 720 pickup 1983>1985, Pulsar 1983, Pulsar NX 1983>1986;

SUBARU: Brat 1978>1987, DL / GL 1980>1989, Loyale 1990>1994, Standard 1981>1987;

SUZUKI: Swift 1989>1991;

TOYOTA: Celica 1981>1985, Corolla 1981>1982, Corona 1981>1982, Tercel 1981>1982

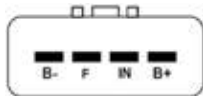
HITACHI
GC4222 // NEW //

FEATURES / CARACTERÍSTICAS: WITH IGNITION MODULE

REPLACES / REEMPLAZA:
Hitachi: 138723; **Toyota:** 90080-19007, 90080-19008, 90919-02217, 90919-02218, 90919-02220, 90919-02226; **Beru:** ZSE197; **Bremi:** 20385; **Meat & Doria:** 10445, 10682; **Wells:** C1134; **Mobiletron:** CT-30; **Transpo:** CUF180

APPLICATION / APLICACIÓN:
TOYOTA: Corolla hatch/ saloon/ estate 1.4 1997>2000, Hilux VI Pickup 2.4i 4WD 1997>2005, Hi-Ace Mk4 minibus/van 2.7 4WD 1998>2006, Avensis Mk1 Saloon 2.0 1997>2000

HITACHI
GC4230

FEATURES / CARACTERÍSTICAS: 2 PIN / WITHOUT IGNITION MODULE

REPLACES / REEMPLAZA:
Hitachi: CM1T-230A; **Mobiletron:** CN-07; **Regitar:** RUF595

APPLICATION / APLICACIÓN:
NISSAN: Pathfinder 3.3 V6, Vehicles 1996-2000 Motor 3.3 V6

HITACHI
GC4379 // NEW //
FEATURES / CARACTERÍSTICAS: 4 PIN / WITH IGNITION MODULE

REPLACES / REEMPLAZA:
Hitachi: 138806, 2508806; **Lada:** TY4218256003, 21120370501002, 21120370501003, 21120370501007, 2112370501002, 2112370501102; **Mobiletron:** CE138; **Regitar:** RCE138; **Meat & Doria:** 10681; **Bremi:** 20387; **NGK:** 48081

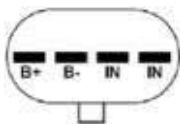
APPLICATION / APLICACIÓN:
LADA: 110 1.5 16V 1995>2005, 111 1.5 1996>2005 / 1.5 16V 1995>2005, 112 1.5 1995>2005 / 1.5 16V 1995>2005, Kalina estate 1.6 2004>2013, Nadeschda 1.7i 1997>2006

HITACHI
GC4572 // NEW //
FEATURES / CARACTERÍSTICAS: 2 PIN / WITHOUT IGNITION MODULE

REPLACES / REEMPLAZA:
Hitachi: 138825; **Delphi:** GN10028-11B1; **Ford:** E8GY12029B, E9Z12029B; **Mazda:** FEAN1810X, F21018100, F21018100B, F21118100A, F2851810XA, F2861810X, F2861810XA, F2871810X, JE571810X, JF0118100B, JF071810X; **Suzuki:** 3341064B10, 3341064B10000, 3341065B10; **Transpo:** CUF22; **Meat & Doria:** 10428; **Bremi:** 11889; **Era:** 880225; **Mobiletron:** CF-09; **NGK:** 48112

APPLICATION / APLICACIÓN:
MAZDA: 323 Mk3 Hatch/saloon 1.3 1985>1987, 626 Mk2 hatch/saloon 2.0 1985>1987, 626 Mk3 hatch/saloon/estate 2.0/2.2 1987>1992, 929 II 2.0 1984>1987, E2000 1991>2003

SUZUKI: Swift Mk1 hatch 1.3 Gti/Gxi 1985>1989, Swift Mk2 hatch 1.3 GTi 1989>2001

HITACHI
GC4817 // NEW //
FEATURES / CARACTERÍSTICAS:
REPLACES / REEMPLAZA:
HITACHI: 138817; **MAGNETI MARELLI:** 138817; **MOBILETRON:** CF-56

APPLICATION / APLICACIÓN:
FORD: Cougar 2.5 St 200 2000>2001, Cougar 2.5 V6 24V 1998>2001, Mondeo Iii 2.5 V6 24V 2000>2007, Mondeo Iii 3.0 V6 24V 2004>2007, Mondeo Iii St220 2002>2007, Mondeo Iii Sedan 2.5 V6 24V 2000>2007, Mondeo Iii Sedan 3.0 V6 24V 2004>2007, Mondeo Iii Sedan St220 2002>2007, Mondeo Iii Turnier 2.5 V6 24V 2000>2007, Mondeo Iii Turnier 3.0 V6 24V 2004>2007, Mondeo Iii Turnier St220 2002>2007, Taurus 3.0 V6 1999>1999

HITACHI
GC4823 // NEW //
FEATURES / CARACTERÍSTICAS:
REPLACES / REEMPLAZA:
HITACHI: 138823; **CARGO:** 138823

APPLICATION / APLICACIÓN:
SUBARU: Forester 2.0 Awd 1997>2005, Forester 2.0 S Turbo Awd 2002>2005, Forester 2.0 X Awd 2005>2008, Forester 2.5 Awd 2003>2005, Impreza Sw 2.0 I 16V Awd 1998>2000, Impreza Sw 2.0 Awd 2000>2007, Impreza Sw 2.0 I R Awd 2005>2007, Impreza Sedan 2.0 I Awd 2000>2009, Legacy Iii 2.0 Awd 1999>2003, Legacy Iii 2.5 Awd 1998>2003, Legacy Iii Sw 2.0 Awd 1998>2003, Legacy Iii Sw 2.5 Awd 1998>2003, Legacy Iv 2.0 Awd 2005>2009, Legacy Iv 2.5 Awd 2003>2009, Legacy Iv Sw 2.0 Awd 2005>2009, Legacy Iv Sw 2.5 Awd 2003>2009, Outback 2.5 Awd 2000>2003

HITACHI
GC4900 // NEW //
FEATURES / CARACTERÍSTICAS: 3 PIN / WITHOUT IGNITION MODULE

REPLACES / REEMPLAZA:
Hitachi: 138790; **Bosch:** 0 221 503 001; **Chevrolet:** 90443900, 90449572; **Opel:** 1208065; **Mobiletron:** CE63; **Regitar:** RCE63; **Meat & Doria:** 10386; **Bremi:** 20169; **Beru:** ZS300; **Magneti Marelli:** BI0069MM

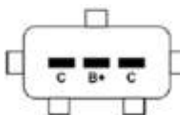
APPLICATION / APLICACIÓN:
OPEL: Calibra A 2.0i 16V 1990>1994, Astra F hatch/estate 2.0 GSI 16V 1991>1998, Frontera A Sports 2.0i 1992>1998, Omega B saloon/estate 2.0 1994>1999, Vectra A saloon 2000/GT 16V 1990>1995

HONDA
GC4047
FEATURES / CARACTERÍSTICAS: 3 PIN / WITH IGNITION MODULE

REPLACES / REEMPLAZA:
Honda: 30520PGKA01, 30520PBEA00, 30520PVFA01, 30520RDJA01; **Magneti Marelli:** BAEQ088; **Meat & Doria:** 10562; **Mobiletron:** CH-23; **Regitar:** RUF400; **WAI/Transpo:** CUF400; **Beru:** ZSE170; **Honda:** 30520-P8F-A02, 30520-PDK-A01

APPLICATION / APLICACIÓN:
HONDA: Civic VII Hatchback 99>06, Civic VII Stufenheck 00>06, Civic VII Coupé 01>05, Accord VI Coupé 97>03

HONDA
GC4205 // NEW //

FEATURES / CARACTERÍSTICAS: 3 PIN

REPLACES / REEMPLAZA:
Honda: 30520-55A, FK0445, 30520-55A-0050

APPLICATION / APLICACIÓN:
HONDA: City 1.5 16V, WRV 1.5 16V, Fit 1.5 16V 2015>2018

HONDA
GC4610 // NEW //

FEATURES / CARACTERÍSTICAS:
REPLACES / REEMPLAZA:
Honda: 30500PAAA01, 30500PCA003, 30500PDAE01, 30500P0AA01, 30500P0HA01; **ISUZU:** 5862061610, 5862071980; **ROVER:** GCL207, NEC100750; **HITACHI:** 138810, CM1T228, CM1T228B, CM1T228C

APPLICATION / APLICACIÓN:
HONDA: Accord V 1.9 I 1996>1998, Accord V 2.0 I Ls 1996>1998, Accord V 2.2 I Vtec 1996>1998, Accord Vi 1.8 I 1998>2002, Accord Vi 2.0 I 1998>2001, Accord Vi 2.3 2001>2003, Accord Vi Coupé 2.0 I 16V 1998>2003, Accord Vi Hatchback 1.8 I 1999>2002, Accord Vi Hatchback 2.0 1999>2002, Accord Vi Hatchback 2.3 2000>2002, Civic V Coupé 1.6 I Vtec 1994>1996, Civic Vi Aerodeck 1.5 16V 1998>2001, Civic Vi Fastback 1.4 I 1995>2001, Civic Vi Fastback 1.5 16V 1997>2001, Civic Vi Fastback 1.6 1998>2000, Civic Vi Fastback 1.6 I 1994>1997, Civic Vi Hatchback 1.6 I 1995>2001, Shuttle 2.3 16V 1997>2004; **ROVER:** 400 416 Si 1995>1999, 400 Hatch 416 Si 1995>2000, 600 618 I/Si 1996>1999, 600 620 Si 1993>1999, 600 620 I 1993>1996

HYUNDAI
GC4266

FEATURES / CARACTERÍSTICAS: 4 PIN / WITHOUT IGNITION MODULE

REPLACES / REEMPLAZA:
Hyundai: 27301-26600; **MEAT E DORIA:** 10452; **TRANSPO:** CUF424; **NGK:** 48287; **MOBILETRON:** CK-17

APPLICATION / APLICACIÓN:
HYUNDAI: Accent Mk2 hatch 1.5/1.6 2000>2005, Accent Mk2 Saloon 1.6 2002>2005, Accent Mk3 hatch/saloon 1.4/1.6 2005>2010, Coupe Mk2 1.6 16v 2002>2009, Elantra Mk3 hatch /saloon 1.6 2003>2006, Getz hatch 1.4/1.6 2002>2010, Matrix 1.6 2001>2010

KIA: Cerato Saloon 1.6 2004>, Cerato hatch 1.6 2004>, Rio Mk2 Saloon 1.4/1.6 2005>

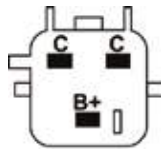
HYUNDAI
GC4419

FEATURES / CARACTERÍSTICAS: 3 PIN / 2 COILS / WITHOUT IGNITION MODULE

REPLACES / REEMPLAZA:
Hyundai / KIA: 27301 - 23700, 27301-23710; **USA Group:** C1434, UF419; **Wells:** C1434; **Standard:** UF419; **Mitsubishi:** 158956; **Mobiletron:** CK-10; **Magneti Marelli:** BAE680V; **Regitar:** RUF419

APPLICATION / APLICACIÓN:
HYUNDAI: Elantra 2003>2006, Tiburon 2003>2008, Tucson L4-2.0L 2005>2009, Tucson 2.0 16V 2001>2004;

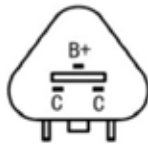
KIA: Spectra 2004>2009, Spectra5 2005>2009, Sportage L4-2.0L 2005>2007, Sportage 2.0 16V

HYUNDAI
GC4600

FEATURES / CARACTERÍSTICAS: 2 PIN / WITHOUT IGNITION MODULE

REPLACES / REEMPLAZA:
HYUNDAI: 27301-02600; **MEAT & DORIA:** 10368; **MOBILETRON:** CK-04; **REGITAR:** RCK04; **NGK:** 48170; **BREMI:** 20143; **BERU:** ZS266

APPLICATION / APLICACIÓN:
HYUNDAI: Amica 1.0i 1998>2000, Amica 1.0i 2001>2003, Atos Prime 1.0i 1999>, Atos Prime 1.0i 2001>2003

FEATURES / CARACTERÍSTICAS:
REPLACES / REEMPLAZA:

ALFA ROMEO: 60534211, 60537610, 19500.65079.00, 195006507900, 60513069, 60534211, 60537610, 60568851, 60576437, 60590027, 60590029; **CITROËN:** 5970-35, 597035, 91535633; **FIAT:** 60513069, 91535633, 9751739080; **HYUNDAI:** 27310-21020; **MERCEDES-BENZ:** 1584003; **VOLVO:** 13178108; **VALEO:** 245025; **NGK:** 48341; **BREMI:** 11814; **ERA:** 880022

APPLICATION / APLICACIÓN:

ALFA ROMEO: 164 (164_) 3.0 V6 (164.A) 1987>1992, 164 (164_) 3.0 V6 (164.AD, 164.AH, 164.AB) 1987>1992, 164 (164_) 3.0 i.e. QV (164.AG) 1990>1992, 33 (907A_) 1.4 i.e. (907.A3A, 907.A3B) 1991>1994, 33 (907A_) 1.5 (907A2) 1990>1993, 33 (907A_) 1.7 16V (907.A1C) 1990>1994, 33 (907A_) 1.7 16V 4x4 (907.A1G) 1990>1994, 33 (907A_) 1.7 i.e. (907.A1A) 1992>1994, 33 Sportwagon (907B_) 1.4 i.e. (907B3B) 1991>1994, 33 Sportwagon (907B_) 1.5 i.e. (907B2B) 1990>1994, 33 Sportwagon (907B_) 1.7 16V (907.B1G) 1990>1994, 33 Sportwagon (907B_) 1.7 16V 4x4 (907.B1H) 1990>1994, 33 Sportwagon (907B_) 1.7 i.e. (907.B1A) 1992>1994, 33 Sportwagon (907B_) 1.7 i.e. 4x4 (907.B1E) 1990>1992, 75 (162B_) 1.6 (162B2) 1985>1989, 75 (162B_) 1.6 Cat (162.B2B, 162.B2C) 1989>1992, 75 (162B_) 1.8 (162.B1H) 1989>1992, 75 (162B_) 1.8 (162.B1L, 162.B1F) 1988>1992, 75 (162B_) 3.0 V6 (162.B6C) 1990>1992, 90 (162_) 2.0 i.e. (162.A2A, 162.A2E) 1984>1987, ALFASUD Sprint (902_) 1.7 i.e. (902C2D) 1987>1989, ALFETTA (116_) 2.0 (116.55F, 116.56F, 116.55N, 116.56N) 1978>1984, RZ 3.0 V6 Zagato (162D1) 1992>1994, SPIDER (115_) 2000 (11538, 115A1) 1977>1993, SPIDER (115_) 2000 (115A1A) 1990>1993, SZ 3.0 V6 Zagato (162C1) 1988>1994;

ASTON MARTIN: V8 Vantage 1969>1989, V8 Volante 5.3 1978>1989;

CITROËN: BX (XB_) 11 1988>1992, BX (XB_) 14 E 1982>1988, BX (XB_) 14 E 1983>1989, BX (XB_) 14 E 1983>1993, BX (XB_) 15 1987>1992, BX (XB_) 16 1987>1993, BX (XB_) 16 1985>1993, BX (XB_) 16 1982>1988, BX (XB_) 16 1986>1993, BX (XB_) 19 1986>1989, BX (XB_) 19 1986>1989, BX Break (XB_) 1.4 1987>1992, BX Break (XB_) 16 1988>1994, BX Break (XB_) 16 1985>1994, BX Break (XB_) 16 1983>1992, BX Break (XB_) 16 1986>1994, BX Break (XB_) 19 1986>1994, BX Break (XB_) 19 Cat (AZE151) 1986>1994, C25 Platform Truck/chassis (280_, 290_) 2.0 1981>1986, C25 Platform Truck/chassis (280_, 290_) 2.0 1987>1994, C25 Furgão (280_, 290_) 2.0 1991>1994, C25 Furgão (280_, 290_) 2.0 E 1981>1994, C25 Van Passenger (280_, 290_) 1.8 E 1987>1994, C25 Van Passenger (280_, 290_) 2.0 1991>1994, C25 Van Passenger (280_, 290_) 2.0 E 1981>1994, CX II 20 RE 1985>1992, CX II 22 TRS 1985>1992, GS 1.1 1977>1981, GS A 1.3 1978>1986, GS Break A 1.3 1979>1986, GS Break A Spezial 1980>1982, LNA 1.0 1984>1986, LNA 1.1 1982>1985, VISA 1.0 1984>1988, VISA 11 E 1978>1988, VISA 11 E 1982>1991, VISA 11 E 1978>1991, VISA 14 1984>1991, VISA 14 GT 1982>1987, VISA 14 GT 1982>1991, VISA 16 GTI 1985>1986, VISA 16 GTI 1986>1991, VISA Conversível 11 RE 1983>1988, VISA II Super X 1980>1982;

FIAT: Ducato Platform Truck/chassis (290_) 2.0 1990>1994, Ducato Platform Truck/chassis (290_) 2.0 4x4 1990>1994, Ducato Furgão (280_) 1.8 1982>1988, Ducato Furgão (280_) 2.0 1985>1990, Ducato Furgão (280_) 2.0 1982>1990, Ducato Furgão (280_) 2.0 1989>1990, Ducato Panorama (280_) 1.8 1982>1988, Ducato Panorama (280_) 2.0 1986>1990, Ducato Panorama (290_) 2.0 1990>1994, Ducato Panorama (290_) 2.0 4x4 1990>1994, Talento Platform Truck/chassis (290_) 2.0 (290UA4) 1989>1994, Talento Furgão (290_) 2.0 (290UA4) 1989>1994;

JAGUAR: XJ (X350, X358) R 4.2 2003>2009, XJ (XJ40, XJ81) 6 3.2 24V 1990>1994, XJ (XJ40, XJ81) 6 3.6 1986>1989, XJ (XJ40, XJ81) 6 3.6 1986>1989, XJ (XJ40, XJ81) 6 4.0 1989>1994, XJ 6 4.2 1979>1987, XJ Coupé 3.6 1983>1989, XJ Coupé 3.6 1983>1988, XJ Coupé 4.0 1991>1994, XJ Coupé 4.0 1994>1996, XJ Coupé 5.3 1991>1993, XJSC Convertible (X27) 3.6 1987>1991, XJSC Convertible (X27) 3.6 1986>1988, XJSC Convertible (X27) 4.0 1991>1994, XJSC Convertible (X27) 5.3 1991>1993;

LADA: 110 (2110) 1.5 16V 1995>2005, 111 (2111) 1.5 16V 2000>2005, 111 (2111) 1.5 16V 1995>2002, 112 (2112) 1.5 16V 2000>2005, 112 (2112) 1.5 16V 1995>2000, Nova (2105) 1700 I Classic (Vaz2107) 1996>2012, Nova Sw (2104) 1700 (21044) 1994>2012, Samara (2108, 2109, 2113, 2114) 1100 1988>1994, Samara (2108, 2109, 2113, 2114) 1100 1996>1999, Samara (2108, 2109, 2113, 2114) 1300 1991>1999, Samara (2108, 2109, 2113, 2114) 1300 1987>1996, Samara (2108, 2109, 2113, 2114) 1300 1986>1994, Samara (2108, 2109, 2113, 2114) 1500 1991>1996, Samara (2108, 2109, 2113, 2114) 1500 1995>2006, Samara (2108, 2109, 2113, 2114) 1500 1987>1996, Samara Forma Sedan (21099, 2115) 1500 1991>1996, Samara Forma Sedan (21099, 2115) 1500 1994>2006...**CONTINUE**



HYUNDAI
GC4851 // NEW //
FEATURES / CARACTERÍSTICAS:
REPLACES / REEMPLAZA:
ALFA ROMEO: 60534211, 60537610, 19500.65079.00, 195006507900, 60513069, 60534211, 60537610, 60568851, 60576437, 60590027, 60590029; **CITROËN:** 5970-35, 597035, 91535633; **FIAT:** 60513069, 91535633, 9751739080; **HYUNDAI:** 27310-21020; **MERCEDES-BENZ:** 1584003; **VOLVO:** 13178108; **VALEO:** 245025; **NGK:** 48341; **BREMI:** 11814; **ERA:** 880022

APPLICATION / APLICACIÓN:

...LADA: Samara Forma Sedan (21099, 2115) 1500 1991>1996 ;

LAND ROVER: 110/127 (Ldh) 3.5 4X4 1984>1990, Discovery I (Lj) 3.5 4X4 (Salljg) 1989>1994, Discovery I (Lj) 4.0 4X4 1993>1998, Range Rover I 3.5 4X4 1987>1990, Range Rover I 3.5 Vogue 4X4 1981>1990, Range Rover I 3.5 Vogue 4X4 1985>1990, Range Rover I 3.9 Cat 4X4 1988>1994, Range Rover I 3.9 Vogue Sei 4X4 1988>1994, Range Rover I 4.3 Vogue Lse 4X4 1992>1994;

MERCEDES BENZ: 123 Coupé (C123) 230 Ce (123.243) 1980>1985, 123 Sedan (W123) 200 (123.220) 1980>1985, 123 Sedan (W123) 230 E (123.223) 1980>1985, 123 Sedan (W123) 280 E (123.033) 1976>1985, 123 T-Model (S123) 200 T 1980>1985, 123 T-Model (S123) 230 Te (123.283) 1980>1985, 123 T-Model (S123) 280 Te (123.093) 1977>1985, 124 Sedan (W124) 200 (124.020) 1985>1990, 124 Sedan (W124) 200 E (124.021) 1988>1993, 124 Sedan (W124) 230 E (124.023) 1984>1992, 124 Sedan (W124) 230 E Cat (124.023) 1989>1993, 124 T-Model (S124) 200 T (124.080) 1985>1989, 124 T-Model (S124) 200 Te (124.081) 1988>1992, 124 T-Model (S124) 230 Te (124.083) 1985>1992, 124 T-Model (S124) 230 Te Cat (124.083) 1989>1992, 190 (W201) 2.0 (201.022) 1982>1984, 190 (W201) 2.0 (201.023) 1986>1990, 190 (W201) 2.0 (201.023) 1983>1990, G-Class (W460) 230 Ge (460.2) 1982>1992, G-Class (W460) 280 Ge (460.2) 1979>1989, S-Class (W126) 280 S (126.021) 1979>1985, S-Class (W126) 280 Se, Sel (126.022, 126.023) 1979>1985, SI (R107) 280 SI (107.042) 1974>1985, SI (R107) 350 SI (107.043) 1971>1980;

PEUGEOT: 104 1.0 1983>1988, 104 1.1 1980>1988, 104 1.4 1979>1983, 104 Coupé 1.1 1979>1988, 104 Coupé 1.4 1979>1984, 205 I (741A/C) 1.0 1983>1987, 205 I (741A/C) 1.1 1983>1987, 205 I (741A/C) 1.1 1983>1987, 205 I (741A/C) 1.4 1983>1987, 205 I (741A/C) 1.4 1983>1987, 205 I (741A/C) 1.6 1987>1987, 205 I (741A/C) 1.6 1986>1987, 205 I (741A/C) 1.6 Gti 1984>1987, 205 I (741A/C) 1.6 Gti 1983>1987, 205 I (741A/C) 1.9 Gti 1986>1987, 205 I Conversivel (741B, 20D) 1.4 Cj 1988>1989, 205 I Conversivel (741B, 20D) 1.4 Ct 1986>1988, 205 I Conversivel (741B, 20D) 1.6 Cti 1986>1990, 205 I Conversivel (741B, 20D) 1.9 Cti 1987>1994, 205 I Conversivel (741B, 20D) 1.9 Cti 1987>1990, 205 li (20A/C) 1.0 1987>1998, 205 li (20A/C) 1.1 1987>1990, 205 li (20A/C) 1.6 1987>1998, 205 li (20A/C) 1.6 1987>1998, 205 li (20A/C) 1.6 1990>1992, 205 li (20A/C) 1.6 Gti 1987>1989, 205 li (20A/C) 1.9 Gti 1987>1998, 205 li (20A/C) 1.9 Gti Cat 1987>1994, 205 Caixa/Fastback 1.1 1983>1987, 205 Caixa/Fastback 1.4 1983>1987, 305 I (581A) 1.5 1980>1982, 305 li (581M) 1.3 1982>1985, 305 li (581M) 1.5 1982>1985, 305 li (581M) 1.6 1986>1988, 305 li (581M) 1.6 1982>1988, 305 li (581M) 1.6 1984>1987, 305 li (581M) 1.6 1982>1988, 305 li (581M) 1.9 1986>1988, 305 li (581M) 1.9 1982>1985, 305 li Break (581E) 1.3 1982>1986, 305 li Break (581E) 1.5 1985>1986, 305 li Break (581E) 1.5 1982>1986, 305 li Break (581E) 1.6 1986>1988, 305 li Break (581E) 1.6 1986>1988, 305 li Break (581E) 1.6 1984>1987, 309 I (10C, 10A) 1.1 1985>1989, 309 I (10C, 10A) 1.3 1985>1989, 309 I (10C, 10A) 1.6 1987>1989, 309 I (10C, 10A) 1.6 1985>1989, 309 I (10C, 10A) 1.6 1985>1988, 309 I (10C, 10A) 1.9 1986>1989, 309 I (10C, 10A) 1.9 Gti 1988>1989, 309 I (10C, 10A) 1.9 Gti 1986>1989, 309 li (3C, 3A) 1.9 1989>1993, 405 I (15B) 1.9 1987>1992, 405 I (15B) 1.9 Injection 1987>1992, 405 I Break (15E) 1.9 1988>1992, 405 I Break (15E) 1.9 1988>1992, 405 I Break (15E) 1.9 1988>1992, 504 Break (D, F) 1.8 (F01, E01) 1971>1986, 504 Break (D, F) 2.0 (D11, F11) 1971>1986, 504 Pick-Up (E) 1.6 1980>1987, 504 Pick-Up (E) 1.8 1987>1989, 505 (551A) 1.8 1981>1985, 505 (551A) 1.8 1982>1985, 505 (551A) 1.8 1985>1986, 505 (551A) 2.0 1983>1985, 505 (551A) 2.0 1980>1985, 505 (551A) 2.0 1985>1995, 505 (551A) 2.0 Ti,Sti 1979>1986, 505 (551A) 2.2 1981>1984, 505 (551A) 2.2 Turbo Injection 1984>1988, 505 (551A) 2.2 Turbo Injection 1987>1988, 505 Break (551D) 2.0 1983>1985, 505 Break (551D) 2.0 1985>1987, J5 Platform Truck/Chassis (280L) 2.0 1986>1988, J5 Platform Truck/Chassis (280L) 2.0 1983>1988, J5 Platform Truck/Chassis (290L) 2.0 1990>1994, J5 Furgão (280L) 1.8 1983>1988, J5 Van Passenger (280P) 2.0 1981>1990, J5 Van Passenger (280P) 2.0 1983>1990, J5 Van Passenger (290P) 2.0 1990>1994, J9 Platform Truck/Chassis 2.0 1980>1987, J9 Furgão 1.6 1980>1987, J9 Furgão 2.0 1980>1987;

VOLVO: 240 (P242, P244) 2.0 1984>1985, 240 (P242, P244) 2.0 1984>1993, 240 (P242, P244) 2.3 1983>1985, 240 (P242, P244) 2.3 1984>1989, 240 (P242, P244) 2.3 I Cat 1986>1993, 240 Kombi (P245) 2.3 1986>1987, 240 Kombi (P245) 2.3 1984>1988, 240 Kombi (P245) 2.3 1980>1984, 240 Kombi (P245) 2.3 I Cat 1986>1993, 740 (744) 2.3 1985>1989

HYUNDAI
GC4023
FEATURES / CARACTERÍSTICAS: 2 PIN / WITHOUT IGNITION MODULE

REPLACES / REEMPLAZA:
KIA: 27301-26640; **HYUNDAI:** 27301-26640, 03220-10874; **Mobiletron:** CK-25; **Magneti Marelli:** BAEQ109; **Standard:** UF499; **Regitar:** RUF499; **Transpo:** CUF499

APPLICATION / APLICACIÓN:
HYUNDAI: Elantra 1.6W (2006~2007), Yuedong 1.6W (2006>), Accent 1.6W (2006>);

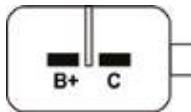
KIA: Rio 1.6 CVVT 05-06, 09

HYUNDAI
GC4130
FEATURES / CARACTERÍSTICAS: 2 PIN / WITHOUT IGNITION MODULE

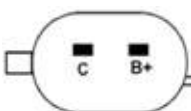
REPLACES / REEMPLAZA:
Hyundai: 27301-3CEA0

APPLICATION / APLICACIÓN:
HYUNDAI: Grandeur 3.3 2005>2011, Sonata Mk5 3.3 2005>2010

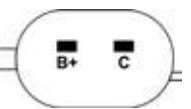
HYUNDAI
GC4274
FEATURES / CARACTERÍSTICAS: 2 PIN / WITHOUT IGNITION MODULE

REPLACES / REEMPLAZA:
Hyundai: 27301-04000; **Regitar:** RCK49; **Magneti Marelli:** BI0079MM; **Delphi:** GN10585

APPLICATION / APLICACIÓN:
HYUNDAI: HB20 1.0 (Sedan/Hatch) 2012~2014; **KIA:** Morning 1.0 / 1.0 bi-fuel 2011~2014

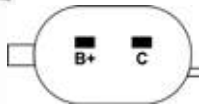
HYUNDAI
GC4277
FEATURES / CARACTERÍSTICAS: 2 PIN / WITHOUT IGNITION MODULE

REPLACES / REEMPLAZA:
Hyundai: 27301-3C000; **Mobiletron:** CK-36; **Standard:** IJF546; **Regitar:** RIJF546

HYUNDAI
GC4278

FEATURES / CARACTERÍSTICAS: 2 PIN / WITHOUT IGNITION MODULE

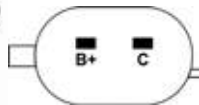
REPLACES / REEMPLAZA:
Hyundai: 27300-2E000; **Mobiletron:** CK-44; **Standard:** UF651; **Regitar:** RUF651; **Magneti Marelli:** BI0166MM

APPLICATION / APLICACIÓN:
Hyundai: IX35, Sonata, Tucson;
Kia: Cerato, Soul, Sportage

HYUNDAI
GC4279

FEATURES / CARACTERÍSTICAS: 2 PIN / WITHOUT IGNITION MODULE

REPLACES / REEMPLAZA:
Hyundai: 27301-3E400; **Standard:** UF558; **Regitar:** RUF558; **Magneti Marelli:** BI0110MM

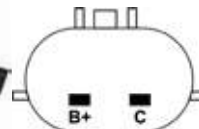
APPLICATION / APLICACIÓN:
Hyundai: Santa Fé 2.7 (4x4) V6 2005>2009;
Kia: Carnival, Optima 2007>2009, Rondo 2007>2009

HYUNDAI
GC4280

FEATURES / CARACTERÍSTICAS: 2 PIN / WITHOUT IGNITION MODULE

REPLACES / REEMPLAZA:
Hyundai: 27300-3F100; **Standard:** UF611; **Mobiletron:** CK-35; **Regitar:** RUF611; **Magneti Marelli:** BI0073MM

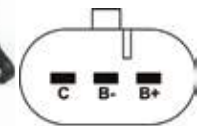
APPLICATION / APLICACIÓN:
Hyundai: IX35, Sonata, Sorento, Equus 2011, Genesis 2009>2010, Genesis Coupe 2010, Santa Fé 2010, Sonata 2008>2011, Tucson 2010>2011;
Kia: Borrego 2009>2011, Forte 2010, Rondo 2009>2010

HYUNDAI
GC4281

FEATURES / CARACTERÍSTICAS: 3 PIN / WITHOUT IGNITION MODULE

REPLACES / REEMPLAZA:
Hyundai: 27301-37410

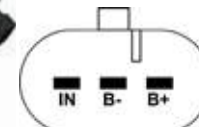
APPLICATION / APLICACIÓN:
Hyundai: Santa Fé GLS Sport 2007>
Kia: Optima EX, LX 2007>

HYUNDAI
GC4282

FEATURES / CARACTERÍSTICAS: 3 PIN / WITH IGNITION MODULE

REPLACES / REEMPLAZA:
Hyundai: 27301-23400, 0324622194, 0119621278;

Champion: BAE 400D; **Mobiletron:** CK-31; **Regitar:** RCK31

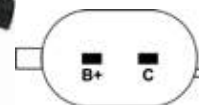
APPLICATION / APLICACIÓN:
Kia: Carens

HYUNDAI
GC4283

FEATURES / CARACTERÍSTICAS: 2 PIN / WITHOUT IGNITION MODULE

REPLACES / REEMPLAZA:
Hyundai: 27301-2B100; **Mobiletron:** CK-42; **Standard:** UF652; **Regitar:** RUF652/RCK42

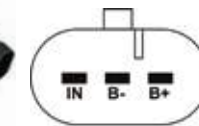
APPLICATION / APLICACIÓN:
Kia: Rio 1.6L 2012>, Soul 1.6L 2012>;
Hyundai: Accent 1.6L 2012>, Veloster 1.6L 2012>
Toyota: Altezza RS200

HYUNDAI
GC4284

FEATURES / CARACTERÍSTICAS: 3 PIN / WITH IGNITION MODULE

REPLACES / REEMPLAZA:
Hyundai: 27301-3E100;

Standard: UF554; **Mobiletron:** CK-53; **Regitar:** RUF554

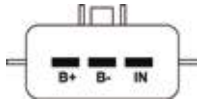
APPLICATION / APLICACIÓN:
Kia: Optima 2.7L V6 2007>2008;
Hyundai: Santa Fé 2.7L V6 2007

HYUNDAI
GC4285

FEATURES / CARACTERÍSTICAS: 3 PIN / WITH IGNITION MODULE

REPLACES / REEMPLAZA:

Hyundai/Kia: 27300-39800; TRANSPORT: CUF2104

APPLICATION / APLICACIÓN:

Kia: Sorento Mk1 SUV 3.5 V6 4WD 2002>

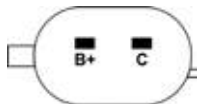
HYUNDAI
GC4286

FEATURES / CARACTERÍSTICAS: 2 PIN / WITHOUT IGNITION MODULE

REPLACES / REEMPLAZA:

Hyundai: 27301-2B010, 0986221063; MOBILETRON: CK-32; Standard: UF636; Regitar: RCK32

APPLICATION / APLICACIÓN:

HYUNDAI: I30 1.6 2007>, Creta 1.6 2017>; KIA: Cerato 1.6 2006>, Soul 1.6 2009>

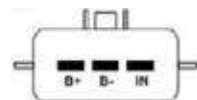
HYUNDAI
GC4380

FEATURES / CARACTERÍSTICAS: 3 PIN / WITH IGNITION MODULE

REPLACES / REEMPLAZA:

Hyundai: 27301-38020, 27301-38010; MEAT E DORIA: 10401; MOBILETRON: CK-24; REGITAR: RUF285

APPLICATION / APLICACIÓN:

HYUNDAI: Starex 2.4 2001>2004, Santa Fé 2.0/2.4 2001>2006, Sonata Mk3 2.0/2.4 1998>2004, Trajet 2.0 2004>2008

KIA: Magentis Mk1 Saloon 2.0 2001>2005, Sorento Mk1 2.4 2002>, Sorento Mk1 2.4 2002>

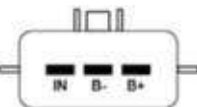
HYUNDAI
GC4601

FEATURES / CARACTERÍSTICAS: 3 PIN / WITH IGNITION MODULE

REPLACES / REEMPLAZA:

Hyundai: 22448-6N015; HITACHI: IGC0010; MEAT E DORIA: 10487; TRANSPORT: CUF351; NGK: 48139; MOBILETRON: CN-14; REGITAR: RUF351

APPLICATION / APLICACIÓN:

NISSAN: Almera hatch 2.0 1996>2000, Primera Mk2 hatch 2.0 16v 1996>2002, Primera Mk2 2.0 16v 1996>2001

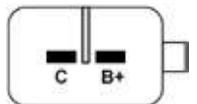
HYUNDAI
GC4702

FEATURES / CARACTERÍSTICAS: WITHOUT IGNITION MODULE

REPLACES / REEMPLAZA:

Hyundai: 27300-85010, 10E2702

APPLICATION / APLICACIÓN:

HYUNDAI: Space, Santa Fé, Sonata

TOYOTA: Supra Twin Turbo Hatchback 2-Door 3.0L 1993>1998

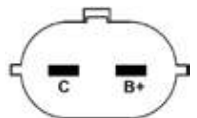
ISUZU
GC4923

FEATURES / CARACTERÍSTICAS: WITHOUT IGNITION MODULE

REPLACES / REEMPLAZA:

ISUZU: 8-94338-923-0, 19017120, 8-94371-838-0; GM: 94 371 838; OPEL: 43 04 227; MOBILETRON: CG-09

APPLICATION / APLICACIÓN:

ISUZU: Trooper 2.6 87>91

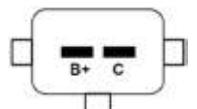
JAC
GC4102

FEATURES / CARACTERÍSTICAS: 2 PIN / WITHOUT IGNITION MODULE

REPLACES / REEMPLAZA:

Jac: 1026102GAA, 1026108GAA, L20069

APPLICATION / APLICACIÓN:

JAC: T6, J6 (All with engine 2.0 16V)

KIA
GC4026
FEATURES / CARACTERÍSTICAS: 2 PIN / WITHOUT IGNITION MODULE

REPLACES / REEMPLAZA:
KIA: 0K013-18-100, 88921371, E501C; **CHRYSLER / MITSUBISHI:** MD362907; **HYUNDAI:** 0K01318100; **Mobiletron:** CK-08; **Magneti Marelli:** BAEQ097; **Standard:** UF283; **Regitar:** RUF283

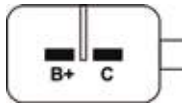
APPLICATION / APLICACIÓN:
KIA: Sportage 95-02

KIA
GC4810 // NEW //
FEATURES / CARACTERÍSTICAS:
REPLACES / REEMPLAZA:
KIA: 0K30E1810X; **TRANSPO:** CUF335; **BERU:** ZS486; **BREMI:** 20343; **MEAT & DORIA:** 10449; **MOBILETRON:** CK-19; **REGITAR:** RUF335

APPLICATION / APLICACIÓN:
KIA: Carens 1.6 2002>, Rio Mk1 saloon/estate 1.5 16V 2000>2005, Shiuma Mk2 hatch/saloon 1.6 2001>2004

MAGNETI MARELLI
GC4029
FEATURES / CARACTERÍSTICAS: 3 PIN / WITHOUT IGNITION MODULE

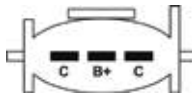
REPLACES / REEMPLAZA:
988F-12029-AC; Magneti Marelli: BI005SSM; **WAI/Transpo:** CFD497, CUF7140E; **Mobiletron:** CF-46; **Magneti Marelli:** BAEQ038; **Regitar:** RFD497

APPLICATION / APLICACIÓN:
FORD: Fiesta, Courier, Escort Zetec

MAGNETI MARELLI
GC4052 // NEW //
FEATURES / CARACTERÍSTICAS:
REPLACES / REEMPLAZA:
Magneti Marelli: 060717117012; **DELPHI:** GN10481-12B1; **GM:** 01115467, 1115467, 96165049

APPLICATION / APLICACIÓN:
DAEWOO: Espero 1.5 16V 1993>1999, Espero 1.8 1995>1999, Espero 2.0 1993>1999, Nexia 1.5 1995>1997, Nexia 1.5 16V 1995>1997, Nexia Sedan 1.5 1995>1997, Nexia Sedan 1.5 16V 1995>1997

MAGNETI MARELLI
GC4103
FEATURES / CARACTERÍSTICAS: 2 PIN / WITHOUT IGNITION MODULE

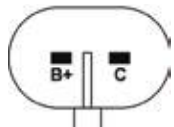
REPLACES / REEMPLAZA:
Bosch: F000ZS0103; **Fiat:** 46548037; **Magneti Marelli:** 0780002010, BAEQ029, BAE800B; **Delphi:** CE10103; **Mobiletron:** CE-08; **Regitar:** RUF1307; **VW:** BAE800B

APPLICATION / APLICACIÓN:
FIAT: Siena 1.3, 1.5 98-05, UNO 1.5 Spi, Mile Mpi 93-03 Fiorino 94-04, Elba 93-96, Premio 92-93, Palio 1.0, 1.5 8V 98-02, Strada 1.0/1.5 8V,TE

MAGNETI MARELLI
GC4903 // NEW //
FEATURES / CARACTERÍSTICAS: 3 PIN

REPLACES / REEMPLAZA:
MAGNETTI MARELLI: BAEQ107; **MITSUBISHI:** MD361710, MD362903; **HITACHI:** 134050

APPLICATION / APLICACIÓN:
MITSUBISHI: Carisma 1.6 1995>2006, Carisma Stufenheck 1.6 1996>2006, Colt III 1.3 1998>1992, Colt IV 1.3/1.6 1992>1996, Colt V 1300 1996>2003, Lancer IV 1.3 1990>1992, Lancer IV Schrägheck 1.3/1.6 1992>1994, LANCER V 1.3/1.6 1992>1996, Lancer V Station Wagon 1.6 1992>2003, Lancer VI 1.3 1995>2003, Lancer VII 1.3/1.6 2003>2013, Lancer VII Kombi 1.6 1993>2008, Space Star Großraumlimousine 1.3/1.6 1998>2004

MAZDA
GC4771 // NEW //
FEATURES / CARACTERÍSTICAS: 3 PIN / WITH IGNITION MODULE

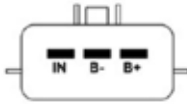
REPLACES / REEMPLAZA:
Mazda: ZM0118100; **Mobiletron:** CF-66; **Regitar:** RUF276; **Transpo:** CUF276

APPLICATION / APLICACIÓN:
MAZDA: Protege 1991>2001, 323 Mk6 hatch 1.5 16V / 1.6 1998>2004, 323 Mk6 saloon 1.5 16V / 1.6 1998>2004

MAZDA
GC4772 // NEW //
FEATURES / CARACTERÍSTICAS: 3 PIN / WITH IGNITION MODULE

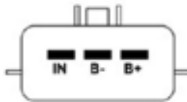
REPLACES / REEMPLAZA:
Mazda: FFY118100, FPY118100, FP8518100C, FFY118100BB; **Transpo:** CUF407; **NGK:** 48208; **Beru:** ZSE083; **Bremi:** 20406; **Meat & Doria:** 10666; **Mobiletron:** CF-57; **Regitar:** RUF407

APPLICATION / APLICACIÓN:
MAZDA: Protege 2001>2003, 323 Mk6 hatch 1.9/2.0 1998>2004, 323 Mk6 saloon 1.9/2.0 1998>2004, 626 Mk4 hatch/saloon 1.8 1991>1997, Premacy 1.9/2.0 1999>2005

MAZDA
GC4773
FEATURES / CARACTERÍSTICAS:
REPLACES / REEMPLAZA:
Mazda: ZL01-18-100, ZL01-18-100A, ZL01-18-100B, ZZY1-18-100

Transpo: CUF2403

Mobiletron: CF-55

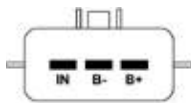
Regitar: RCF55

APPLICATION / APLICACIÓN:
MAZDA: 323 F/P MK6 hatch, 323 S MK6 Saloon 1.5

MAZDA
GC4812 // NEW //
FEATURES / CARACTERÍSTICAS: 3 PIN

REPLACES / REEMPLAZA:
Mazda: L3G2-18-100B-9U; **FORD:** 6M8G-12A366; **MOBILETRON:** CF-71; **REGITAR:** RUF540; **MEAT&DORIA:** 10608; **BREMI:** 20533; **TRANSPO:** CUF2873

APPLICATION / APLICACIÓN:
MAZDA: 3 Hatch 2.0/2.3 MPS Turbo 2003>2009, 3 Saloon 2.0 2003>2009, 5 MPV 2.0 2005>2010, 6 hatch 2.0 2002>2007, CX-7 2.3 2007>2013, Tribute 2.3 2003>2008

MITSUBISHI
GC4303
FEATURES / CARACTERÍSTICAS: 2 PIN / WITHOUT IGNITION MODULE

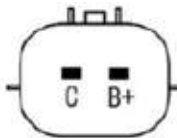
REPLACES / REEMPLAZA:
Mitsubishi: H3T03273; **REGITAR:** RUF453; **MOBILETRON:** CF-24

APPLICATION / APLICACIÓN:
NISSAN: Almera hatch 2.0 1996>2000, Almera Tino 2.0 2000>2003, Primera Mk2 hatch 2.0 16v 1996>2002, Primera Mk2 2.0 16v 1996>2001, Primera Mk2 Estate 2.0 16v 1996>2001

MITSUBISHI
GC4397
FEATURES / CARACTERÍSTICAS: WITHOUT IGNITION MODULE

REPLACES / REEMPLAZA:
Mitsubishi: H3T0397; **REGITAR:** RUF452; **MOBILETRON:** CF-32

APPLICATION / APLICACIÓN:
SUZUKI: Vitara 1993>1996, Sidekick 1.6 1993>1996

MITSUBISHI
GC4427 // NEW //
FEATURES / CARACTERÍSTICAS: 2 PIN / WITHOUT IGNITION MODULE

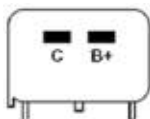
REPLACES / REEMPLAZA:
Mitsubishi: MD314582, J5365011; **Mobiletron:** CM-12; **Bremi:** 20444; **Meat & Doria:** 10672; **Era:** 880463

APPLICATION / APLICACIÓN:
MITSUBISHI: Shogun/Pajero Mk2 3.5 V6 24V 1994>1999, Shogun/Pajero Mk2 Soft Top 3.0 V6 24V 1994>2000, Shogun/Pajero Sport 3.0 V6 1998>

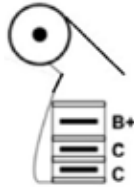
MITSUBISHI
GC4695

FEATURES / CARACTERÍSTICAS: 3/2 PIN / WITHOUT IGNITION MODULE

REPLACES / REEMPLAZA:

Mitsubishi: H3T023 / F-695; **MOBILETRON:** CF-16 | **Regitar:** RUF969S

APPLICATION / APLICACIÓN:

CHRYSLER: Stratus 2.5 V6 1996>2000

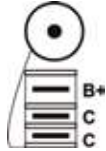
MITSUBISHI
GC4966

FEATURES / CARACTERÍSTICAS: 3 PIN / WITHOUT IGNITION MODULE

REPLACES / REEMPLAZA:

Mitsubishi: H3T024; **Mazda:** 155852, F69651971; **Regitar:** RUF966; **Diamond:** F-696 618393; **Standard:** UF371;

Mobiletron: CF-11

APPLICATION / APLICACIÓN:

MITSUBISHI: Eclipse 1990>1995, Expo 1993>1994, Expo LRV 1992;

MAZDA: 626 1990>1996; **DODGE:** Colt 1993>1994;

EAGLE: Summit 1994>1994;

PLYMOUTH: Colt 1992>1994

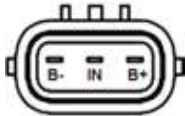
MITSUBISHI
GC4320

FEATURES / CARACTERÍSTICAS: 3 PIN / WITH IGNITION MODDULE

REPLACES / REEMPLAZA:

Mitsubishi: 1832A025, 1832A016; **Citroën/Peugeot:** 597096; **Diamond:** FK0320; **MEAT&DORIA:** 10664; **REGITAR:** RCM15; **MOBILETRON:** CM-15; **NGK:** U5311; **TRANSPO:** CUF2127

APPLICATION / APLICACIÓN:

MITSUBISHI: ASX 1.8 2010>, Grandis 2007>2008, Lancer 1.8 2008>2014, Outlander 2.4 2007>2013, Outlander Sport 2011>2014

CITROËN: C-Crosser Suv 2.4 16V 2007>, C-Crosser Enterprise 2.4 16V 2009>

PEUGEOT: 4007 2.4 16V 2008>

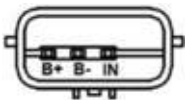
MITSUBISHI
GC4471

FEATURES / CARACTERÍSTICAS: 3 PIN / WITH IGNITION MODULE

REPLACES / REEMPLAZA:

Mitsubishi: H6T11471; **BREMI:** 20679; **MEAT & DORIA:** 10637; **NGK:** 49060

APPLICATION / APLICACIÓN:

MITSUBISHI: Lancer MK 8 Saloon 2.0 i Ralliart 4WD/2.0 EVO X All-wheel Drive 2008>2016, Lancer MK 8 Estate 2.0 Ralliart 4WD 2008>

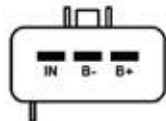
MITSUBISHI
GC4562

FEATURES / CARACTERÍSTICAS: 3 PIN / WITH IGNITION MODULE

REPLACES / REEMPLAZA:

Mitsubishi / Suzuki: H6T11371; **Regitar:** RUF562; **Mobiletron:** CJ-03; **Standard:** UF562; **SUZUKI:** 33400-65J00

APPLICATION / APLICACIÓN:

SUZUKI: Gran Vitara I 1998>2006, Gran Vitara II 2005>2015, SX4 2007>2009

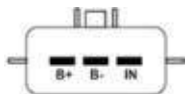
MITSUBISHI
GC4616

FEATURES / CARACTERÍSTICAS: WITH IGNITION MODULE

REPLACES / REEMPLAZA:

Mitsubishi: MN195616; **Smart:** A1351500180, A1351500280, 1351500180, 1351500280; **MOBILETRON:** CM-14; **REGITAR:** RCM14; **TRANSPO:** CUF2447; **NGK:** U5101; **MEAT&DORIA:** 10607

APPLICATION / APLICACIÓN:

MITSUBISHI: Colt Mk6 1.1 / 1.3 / 1.5 2002>2012, Colt CZC Cabrio 1.5 2006>2009;

SMART: Forfour 1.1 / 1.3 / 1.5 2004>2006

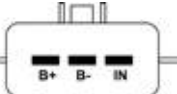
MITSUBISHI
GC4941

FEATURES / CARACTERÍSTICAS: 3 PIN / WITH IGNITION MODULE

REPLACES / REEMPLAZA:

Mitsubishi: MD362907, MD325048, MD361710, MD362903; **Regitar:** RUF141; **Standard:** UF295; **Bosch:** 0221503465; **Denso:** 099700-048; **Hafei:** MD362903; **Lucas:** DMB1010; **Mobiletron:** CC-23; **Magneti Marelli:** BAEQ092, BI0032MM

APPLICATION / APLICACIÓN:

Mitsubishi: Eclipse, Galant, Lancer, Mirage, Outlander;

Chrysler: Sebring;

Dodge: Stratus

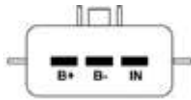
MITSUBISHI
GC4942

FEATURES / CARACTERÍSTICAS: 3 PIN / WITH IGNITION MODULE

REPLACES / REEMPLAZA:
Mitsubishi: 099700-048, C1200C

Standard: UF280

Mobiletron: CT-26

Regitar: RCT26

APPLICATION / APLICACIÓN:
MITSUBISHI: Colt MK 5 hatch 1300 GL, GLX 95>03, Lancer MK 7 Saloon, Estate 1.6 00>, Lancer MK 8 Saloon 2.0 EVO X All-wheel Drive 07>, Space Star 1.3/1.6 16V 98>04

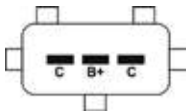
MOTOROLA
GC4370

FEATURES / CARACTERÍSTICAS: 3 PIN / WITHOUT IGNITION MODULE

REPLACES / REEMPLAZA:
Chery: S11-3705110JA; **Motorola:** 101R42076X01, 01R43059X01

APPLICATION / APLICACIÓN:
CHERY: QQ

NISSAN
GC4227

FEATURES / CARACTERÍSTICAS: 2 PIN / WITHOUT IGNITION MODULE

REPLACES / REEMPLAZA:
Hyundai: CM1T-230, CM1T-227; **Nissan:** 22433-F4302; **Mobiletron:** CN-01; **Standard:** UF731; **Regitar:** RUF596

APPLICATION / APLICACIÓN:
NISSAN: 84-99

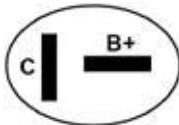
NISSAN
GC4433

FEATURES / CARACTERÍSTICAS: WITHOUT IGNITION MODULE

REPLACES / REEMPLAZA:
Nissan: 22433-18R10, 22433-42L10; **Daewoo:** 96320818, 96336522; **GM:** 94136766; **Hitachi:** CM1T-205; **Holden (AUS):** 2243342L00, 2243342L10; **Isuzu:** 8-94136-766-0; **Opel:** 4294029; **Transpo:** CUF16; **Mobiletron:** CG-10

APPLICATION / APLICACIÓN:
DAEWOO: Matiz/Tico 0.8 98>09;

HOLDEN (AUS): Calais, Commodore 88>07;

ISUZU: Amigo, Pick Up 88>01, Trooper 87>12;

OPEL: Midi 94>08

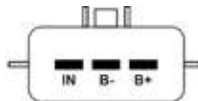
NISSAN
GC4449

FEATURES / CARACTERÍSTICAS: WITH IGNITION MODULE

REPLACES / REEMPLAZA:
Transpo: CUF263; **Mobiletron:** CN-18; **Regitar:** RUF263; **Nissan:** 22448-31U01

APPLICATION / APLICACIÓN:
NISSAN: Maxima QX Mk4 2.0/3.0 94>00, Maxima QX Mk5 2.0/3.0 V6 24V 00>03, Maxima 2.0/3.0 QX 97>00, Datsun 95>99;

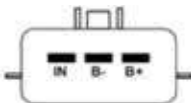
INFINITI: I30 3.0 97>

NISSAN
GC4482

FEATURES / CARACTERÍSTICAS: 3 PIN / WITH IGNITION MODULE

REPLACES / REEMPLAZA:
NISSAN: 22448-2Y005; **TRANSPO:** CUF363; **MEAT & DORIA:** 10516; **BREMI:** 20325; **MOBILETRON:** CN-20; **REGITAR:** RUF363; **BERU:** ZSE082

APPLICATION / APLICACIÓN:
INFINITI: I30 3.0 1997>

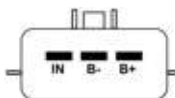
NISSAN: 300ZX 3.0 1984>198, Maxima Mk3 3.0i 1988>1994, Maxima QX Mk4 3.0 1995>2000, Maxima Estate 3.0 QX 1997>2000, Maxima QX Mk5 2.0/3.0 V6 2000>2003, Terrano 1.3.0i 1990>1995

NISSAN
GC4566

FEATURES / CARACTERÍSTICAS: 3 PIN / WITH IGNITION MODULE

REPLACES / REEMPLAZA:
HANSHIN: (22448-8J115) AIC-3102G; **NISSAN:** 22448-8J115, 22448-8J111, 22448-8J11C, 22448J225, 224338J115; **Infiniti:** 224488J11C; **Standard:** UF349; **WELLS:** C1406; **Mobiletron:** CN-31; **Regitar:** RUF349; **Transpo:** CUF349

APPLICATION / APLICACIÓN:
NISSAN: Pathfinder, X Terra, Quest 04>09, NV3500, Maxima 02>08, I35 02>04, Murano 02>06, QX4, 350Z 03>06;

INFINITI: G35 03>04, FX-35 03>05;

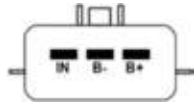
SUZUKI: Equador 09>12.

NISSAN
GC4776

FEATURES / CARACTERÍSTICAS: WITH IGNITION MODULE
REPLACES / REEMPLAZA:
NISSAN: 22448-2Y000, 22448-2Y010; **MOBILETRON:** CN-22; **REGITAR:** RUF348; **MEAT&DORIA:** 10517; **TRANPO:** CUF348

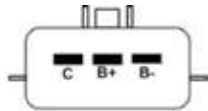
APPLICATION / APLICACIÓN:
NISSAN: Maxima QX Mk4 2.0/3.0 1995>2000, Maxima QX Mk5 2.0 V6 24v 2000>2003, Maxima QX Mk5 3.0 V6 24v 2000>2003
INFINITI: I30 3.0 1997>

NISSAN
GC4777

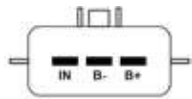
FEATURES / CARACTERÍSTICAS: 3 PIN / WITHOUT IGNITION MODULE
REPLACES / REEMPLAZA:
NISSAN: 22433-60U02, 22448-02U11, 22448-AA100, 22448-AA101, 22448-5L300; **BREMI:** 20411

APPLICATION / APLICACIÓN:
NISSAN: Skyline GT-R (R33) 2.6, Skyline GT-R (R32) 2.6, Skyline (R32) 2.0 1989>1993 - HR32 / HCR32 / HNR32, Skyline (R32) 2.0 1989 >1993 HCR32 / HNR32, Skyline 1991>1993 - RB25DE ER32 / ECR32, Skyline 1993>1995 - RB25DE ER33 / ECR33

NISSAN
GC4778

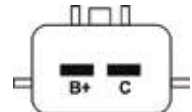
FEATURES / CARACTERÍSTICAS: 3 PIN / WITH IGNITION MODULE
REPLACES / REEMPLAZA:
NISSAN: 22448-8H300, 22448-8H315, 22448-8H310; **Transpo:** CUF350

APPLICATION / APLICACIÓN:
NISSAN: Primera Hatchback 2001>2002, Primera viajeros 2001>2002, X-Trail 2.0/2.5 2006>2013, Altima 2002>, Sentra 2002>

NISSAN/TOYOTA
GC4027

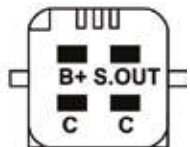
FEATURES / CARACTERÍSTICAS: 2 PIN / WITHOUT IGNITION MODULE
REPLACES / REEMPLAZA:
NISSAN: 22433-53F00, 22433-55Y00, 22433-65Y10, 22448-1C701, 22448-37J10, 22448-37J20, 22433-65Y1093; **Mobiletron:** CN-03; **Standard:** UF118; **Regitar:** RUF118

APPLICATION / APLICACIÓN:
TOYOTA: Serena 1.6 16V 88-97;
NISSAN: Patrol 88-97

PEUGEOT
GC4034

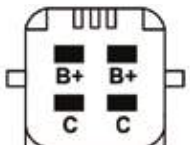
FEATURES / CARACTERÍSTICAS: 4 PIN - GRAY CONECTOR / 1 POLARIZER / WITHOUT IGNITION MODULE
REPLACES / REEMPLAZA:
CITROËN: 597078, 597078+596319, 597079, 597079, 596319, 5970A8, 96358648, 96358649; **Peugeot:** 597078, 597078, 596319, 597079, 597079, 596319, 5970A8, 96358648, 96358649, 9635864980; **Bougicord:** 154302; **Delphi:** CE20120, CE20011; **Mobiletron:** CE-27; **Magneti Marelli:** BAEQ030, BI0036MM; **Standard:** UF683; **Regitar:** RCE27; **Bosch:** 0 986 221 035

APPLICATION / APLICACIÓN:
CITROËN: Berlingo 1.1/1.4i 06/00>12/02, C2 1.1/1.4 09/03, C3 1.1i 02/02 /1.4i Bivalent 02/02>12/05, C3 Plurel 1.4 05/03, Saxo 1.0X /1.1X /1.1SX /1.4VTS 06/00>12/02;
PEUGEOT: 106 II 1.1i /1.4i 06/00, 107 1.3 06/06, 206 1.1i 06/00, 206 1.4i 06/00>12/05, 206 SW 1.1 /1.4 07/02, 206 SW /1.4 16V 10/03, 306 1.4 06/00>12/05, 306 1.4 SL 06/00>05/01, 306 Break 1.4 06/00>12/05, 307 1.4 08/00>12/05, 307 Break /SW 1.4 16V 11/03, 1007 1.4 04/05, Partner 1.1 /1.4 /1.1 /1.4 Combispace 06/00>12/05

PEUGEOT
GC4054

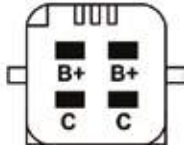
FEATURES / CARACTERÍSTICAS: 4 PIN / BLACK CONECTOR / 2 POLARIZERS / WITHOUT IGNITION MODULE
REPLACES / REEMPLAZA:
PEUGEOT: 597072, 597074, 9628158580, 596319; **CITROËN:** 597072, 597074, 9628158580, 96246755, 96281585; **SAGEM:** 2526117A, 25261174; **VALEO:** 245109; **LUCAS:** DMB812; **BOSCH:** 0986221034; **BOUGICORD:** 154301; **PSA:** 597072, 5970A9, 9624675580, 9628158580; **Mobiletron:** CE-26; **Magneti Marelli:** BAEQ031, BI0035MM; **Standard:** UF688; **Regitar:** RCE26

APPLICATION / APLICACIÓN:
PEUGEOT: 106 /307 /206 1.4i, 1.6i 8V 98-00, 306 1.4 /1.4SL /1.6 /1.6SR 8V 97-00, 306 Break 1.4 /1.6 8V 97-00, 306 Cabrioler 1.6 8V, 406 1.6 8V 97-00, Partner 1.6 8V 00>;
CITROËN: C2/C3 1.1, 1.4 02-03; SAXO(S0,S1) 1.0X/XS/VTS/VTL/VTR 96-03; XSARA /PICASSO 1.4i, 1.6i 97-99

PEUGEOT
GC4074

FEATURES / CARACTERÍSTICAS: 4 PIN – BLACK CONECTOR / 1 POLARIZER / WITHOUT IGNITION MODULE

REPLACES / REEMPLAZA:

Citroën/Peugeot: 597090, 597097, 9654347080; **Bougiecord:** 154303

APPLICATION / APLICACIÓN:

CITROËN: Berlingo 1.1i/1.4 bivalent /1.4i bivalent 01/05, C2 1.1 /1.4 01/05, C3 1.4i 02/02, C3 Pluriel 1.4 05/05;
PEUGEOT: 207 1.4 02/06, 207 SW 1.4 06/07, 1007 1.4 04/05, Partner 1.1 /1.4 /1.4BiFuel /CombiSpace 1.1 /1.4 01/05;

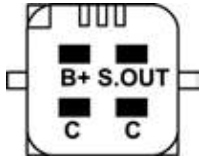
PEUGEOT
GC4094

FEATURES / CARACTERÍSTICAS: 4 PIN / WITHOUT IGNITION MODULE

REPLACES / REEMPLAZA:

Valeo: 9654814480, 26951960-3, 245103; **Standard:** IIS197, 12796, UF695; **Cargo:** 150522; **Era:** 880117; **Meat&Doria:** 10324;
Mobiletron: CE-27; **Regitar:** RCE27

APPLICATION / APLICACIÓN:

Citroën: C3 2009>, C2 2003>, Berlingo 1.4 1996>, Nemo 1.4 2008>;
Peugeot: Ranch 1.4 1996>, 206 1.4 1998>, 207 1.4 2007>, Bipper 1.4 2008>, Tepee 1.4 2008>

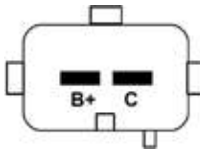
PEUGEOT
GC4055

FEATURES / CARACTERÍSTICAS: 2 PIN | WITHOUT IGNITION MODULE

REPLACES / REEMPLAZA:

Citroën: 96213181; **Peugeot:** 597055; **Sagem:** 2526084; **Beru:** 0040100346

APPLICATION / APLICACIÓN:

CITROËN: Xsara 2.0 16V 1997>2005, Xsara Coupé 2.0 i 16V 1998>2005, ZX 2.0 i 16V 1991>1999;
PEUGEOT: 306 Schrägheck 2.0 1996>2001

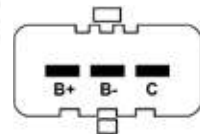
PORSCHE
GC4200

FEATURES / CARACTERÍSTICAS: 3 PIN / WITHOUT IGNITION MODULE

REPLACES / REEMPLAZA:

Bosch: 0 986 221 016;
Lucas: DMB979;
Porsche: 90660210101, 90660210200, 90660210301, 99660210, 99660210400

APPLICATION / APLICACIÓN:

PORSCHE: 911 3.4/3.6/3.8/GT2 2.6/GT3 3.6/Turbo 3.6, Boxster 2.5/S 3.2/S 3.4, Boxster 2.7, Cayman 2.7/3.4

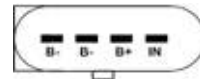
PORSCHE
GC4531

FEATURES / CARACTERÍSTICAS: 4 PIN / WITH IGNITION MODULE

REPLACES / REEMPLAZA:

...

APPLICATION / APLICACIÓN:

Audi: A3 Mk2 Hatch 3-Door/5-Door 3.2 V6 quattro 03>09, Q7 FSI quattro 06>10, TT Coupe Mk1/TT Roadster Cabrio Mk1 3.2 VR6 quattro 03>06, TT Coupe Mk2/TT Roadster Cabrio Mk2 3.2 VR6 quattro 06>10;

Porsche: Cayenne 3.2/3.6 02>;

Skoda: Superb Mk2 3.6 FSI 4x4 08>15 Superb Estate 3.6 V6 4x4 09>15;

VW: Eos Convertible 3.2 V6 06>10, Golf Mk4 Hatch 3.2 R32 4Motion 02>05, Golf Mk5 Hatch 3.2 R32 4Motion 05>08, Passat Mk6 Saloon/ Estate 3.2 FSI 4Motion/3.6 R36 4Motion 05>10, Passat CC Saloon 3.6 FSI 4Motion 08>10, CC 3.6 FSI 4Motion 11>, Passat/Passat Variant 3.6 FSI 4Motion 11>14, Phaeton 3.2 V6/3.2 V6 4Motion/3.6 V6 4Motion 02>16, Touareg 3.2 V6/3.6 V6 FSI 02>10, Touareg 3.6 V6 FSI 10>, Transporter T5 Minibus 3.2 V6/3.2 V6 4Motion 04>09, Transporter T5 Van 3.2 V6/3.2 4Motion 03>09, Transporter T5 Flatbed 3.2 V6 03>06

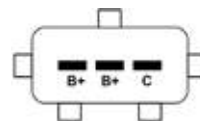
RENAULT
GC4042

FEATURES / CARACTERÍSTICAS: 3 PIN / WITHOUT IGNITION MODULE

REPLACES / REEMPLAZA:

Renault: 7700100589; **Sagem:** 2526114A; **Bosch:** 0986221025; **Lucas:** DMB407

APPLICATION / APLICACIÓN:

RENAULT: Clio II, Kangoo, Kangoo Rapid, Mégane I, Mégane I Classic, Mégane I Coach, Mégane I Cabriolet, Mégane Scénic

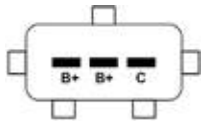
RENAULT
GC4051

FEATURES / CARACTERÍSTICAS: 3 PIN / WITHOUT IGNITION MODULE

REPLACES / REEMPLAZA:
Renault: 708630207, 7700863020, 7701041607, 7700850999, 77008659223; **Valeo:** 245066, 245076; **Volvo:** 708630207, 70863020; **Bosch:** 09866221030; **Lucas:** DMB404

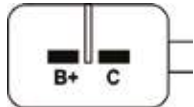
APPLICATION / APLICACIÓN:
RENAULT: Laguna I / II, Laguna I Grandtour, Mégane I, Mégane I Classic, Mégane I Coach, Mégane I Cabriolet, Mégane Scénic; **VOLVO:** S40 I 95>04

RENAULT
GC4131

FEATURES / CARACTERÍSTICAS: 2 PIN / WITHOUT IGNITION MODULE

REPLACES / REEMPLAZA:
Renault: 7700875000, 82 00 405 098; **Bosch:** 0986221001; **Magneti Marelli:** BI0021MM, BAEQ035; **Mobiletron:** CE-28; **Regitar:** RUF770

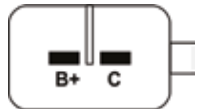
APPLICATION / APLICACIÓN:
RENAULT: Clio/ Sedan, 1.6 16V Hi Flex 04>, Scenic 1.6 1.6V Hi Flex 05>, Megane/ Grand Tour 1.6 16V 06>, Kangoo 1.6 16V 07>, Logan 1.6 16V 07>

RENAULT
GC4132

FEATURES / CARACTERÍSTICAS: 2 PIN / WITHOUT IGNITION MODULE

REPLACES / REEMPLAZA:
Renault: 82007658 82, 7700875000, 78419001, 7700107177, 7700113357, 7700113357A, 0040100052, 8200208611, 8200154186, 8200154186A, 8200380267, 029700-8291, 21595273-2, 2526181A; **Valeo:** 21603121-9, 245104; **Lucas:** DMB804; **Bosch:** 0986221001; **Nissan:** 22448-00QAA, 22448-00QAC, 22448-00QAE; **Opel:** 91159996.4408389; **Mobiletron:** CE-122, CE-152; **Magneti Marelli:** BAE680DG, BI0112MM; **Standard:** UF653; **Regitar:** RCE122, RCE152

APPLICATION / APLICACIÓN:
Renault: Clio, Kangoo, Livina, Logan, Sandero 1.6 16V, Avantime, Espace, Grand Scenic, Laguna, Megane, Modus, Thalia, Trafic II, Vel Satis;

Vauxhall: Vivaro;

Dacia: Logan;

Morgan: Plus Four;

Nissan: Kubistar, Primastar;

Opel: Vivaro

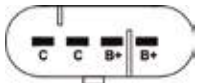
RENAULT
GC4221

FEATURES / CARACTERÍSTICAS: 4 PIN / WITHOUT IGNITION MODULE

REPLACES / REEMPLAZA:
Bosch: F 000 ZS0 221; **Renault:** 7700274008, 7700873701; **Mobiletron:** CE-38; **Magneti Marelli:** BAEQ060, BI0049MM; **Regitar:** RCE38

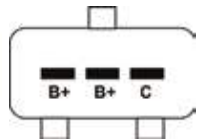
APPLICATION / APLICACIÓN:
RENAULT: Clio, Kangoo, Twingo 1.0, 1.6 8V (motor D7D 760) 00>, Logan 1.0, 1.6 8V (motor D&D 740) 02>

RENAULT
GC4269

FEATURES / CARACTERÍSTICAS: 3 PIN / WITHOUT IGNITION MODULE

REPLACES / REEMPLAZA:
Renault: 7700107269; **Bosch:** 0986 221033; **Mobiletron:** CE-33; **Magneti Marelli:** BAEQ051, BI0041MM; **Regitar:** RCE33; **Valeo:** 245138

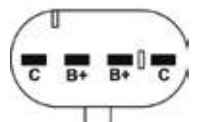
APPLICATION / APLICACIÓN:
RENAULT: Scenic 2.0 96-03/ Megane 2.0 97-03

RENAULT
GC4401

FEATURES / CARACTERÍSTICAS: 4 PIN / WITHOUT IGNITION MODULE

REPLACES / REEMPLAZA:
Renault: 8200084401; **Peugeot:** 598083; **Bosch:** 0986221036; **Magneti Marelli:** BI0025MM, BAEQ055; **Mobiletron:** CE-42; **Regitar:** RCE42

APPLICATION / APLICACIÓN:
PEUGEOT: 206 1.0L 16V 00>;

RENAULT: Clio, Kangoo, Twingo 1.0 16V (gasolina) 06/01>06/04, Kangoo Express 1.0 16V 10/01>06/04

RENAULT
GC4408
FEATURES / CARACTERÍSTICAS: 4 PIN / WITHOUT IGNITION MODULE

REPLACES / REEMPLAZA:
Renault: 8200702693, H8200734204 - 77040001; **Bougicord:** 151408; **Mobiletron:** CE-147; **Magneti Marelli:** BAE680CU, BI0102MM; **Standard:** UF685; **Nissan:** 22448-00QAF, 2246200Q0A; **Bosch:** 0 986 221 046

APPLICATION / APLICACIÓN:
DACIA: Logan Saloon 1.2 16v 2006>, Logan II 1.2 2012>, Logan MCV II 1.2 2013>, Sandero II 1.2 2012>, Sandero Hatch 1.2 16v 2008>; **RENAULT:** Clio Mk2 Hatch 1.2 16v 2001>, Clio Mk3 Hatch/Estate 1.2 16v 2005>, Clio IV 1.2 16v 2012>, Kangoo Mk1 / Mk1 Van 1.2 16v 2001>, Modus hatch 1.2 16v 2004>, Twingo Mk1 Hatch 1.2 16v 2004>2007, Twingo Mk2 Hatch 1.2 16v 2007>

RENAULT
GC4429 // NEW //
FEATURES / CARACTERÍSTICAS: 2 PIN

REPLACES / REEMPLAZA:
RENAULT: 224336695R

APPLICATION / APLICACIÓN:
RENAULT: Sandero 1.6 16V 2017>2018, Captur 1.6 16V 2017>2018, Logan 1.6 16V 2013>2020

RENAULT
GC4911
FEATURES / CARACTERÍSTICAS: 4 PIN / WITHOUT IGNITION MODULE

REPLACES / REEMPLAZA:
Renault: 8200360911; **Mobiletron:** CE-74; **Magneti Marelli:** BAEQ055; **Regitar:** RCE74

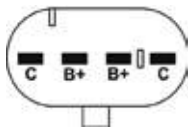
APPLICATION / APLICACIÓN:
RENAULT: Clio, Kangoo 1.0 16V (Hi-Flex) 07/04>12/08, Twingo 1.0 16V (Hi-Flex) 08/04>12/08

RENAULT
GC4022
FEATURES / CARACTERÍSTICAS: 3 TERMINALS / WITHOUT IGNITION MODULE

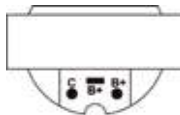
REPLACES / REEMPLAZA:
RENAULT: 7701031135, 7701030273, 33002299, 12336238; **MAGNETI MARELLI:** BAE504B; **VALEO:** 245054, DMB823; **SAGEM:** 2526023, 2526048; **BOSCH:** F-000-ZS0-115; **BERU:** 0040100316, ZS316; **LUCAS:** DLB204, DMB823; **VOLVO:** 3287677, 3287677-3; **Mobiletron:** CE-21; **Magneti Marelli:** BAEQ018; **Standard:** UF50; **Regitar:** RUF50

APPLICATION / APLICACIÓN:
RENAULT: R19 /R21 1.8 /2.0 /Laguna 2.0 84-92

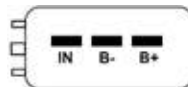
SUBARU
GC4434
FEATURES / CARACTERÍSTICAS: 3 PIN / WITH IGNITION MODULE

REPLACES / REEMPLAZA:
Diamond: FK0186, FK0334, 22433AA418, 22433AA480, 22433AA540, 22433AA541, 22433AA640, 22433AA641; **Transpo:** CUF2168; **Era:** 880493; **Meat&Doria:** 10775

APPLICATION / APLICACIÓN:
SUBARU: Forester Mk2 2.5 XT AWD 05>08, Forester 2.0/2.5 AWD 08>13, Impreza Mk2 Saloon/Estate 1.5 AWD/2.0i R AWD/2.5i WRX AWD/2.5 WRX STI AWD 05>, Impreza Hatchback 2.5 WRX AWD 05>07, Impreza Mk3 Hatch 1.5 F/1.5 AWD/2.0 R AWD/2.5 WRX STI AWD 08>, WRX Saloon STI 2.5 AWD 14>, Legacy Mk4 Saloon/Estate 2.0 R AWD 05>09, Legacy V/V Estate 2.0i AWD 09>14

SUZUKI
GC4077
FEATURES / CARACTERÍSTICAS: WITH IGNITION MODULE

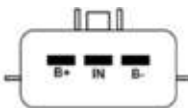
REPLACES / REEMPLAZA:
Suzuki: 33410-77E20, 33410-77E21; **GM:** 91185339, 91175339; **MEAT & DORIA:** 10422; **MOBILETRON:** CU-01; **REGITAR:** RUF237; **NGK:** U5092; **TRANSPO:** CUF237

APPLICATION / APLICACIÓN:
GM: Tracker 1999>2004;

SUZUKI: Aerio 2002>2005, Baleno hatch/saloon 1.8 GTX 1996>2002, Baleno estate 1.8i 16v 1996>2002, Grand Vitara Mk1 2.0/2.5/2.7 1998>2003, Vitara 1999>2004, Grand Vitara Mk2 2.0 2005>2015, Esteem 1999>2002, XL-7 2001>2004, Sidekick 1998, Vitara 2.0 V6 24v 1994>1998

SUZUKI
GC4425
FEATURES / CARACTERÍSTICAS: 3 PIN / WITH IGNITION MODULE

REPLACES / REEMPLAZA:
Suzuki: 33410-77E01, 33400-65G02, 33400-65G00, 33400-65G01, 33410-65G00; **Hyundai:** 9C19-0370; **Mitsubishi:** S37000067PG; **Fiat:** 71742420; **Standard:** UF-280; **Alfa Romeo:** 71742420; **Mobiletron:** CJ-05; **Regitar:** RUF280; **Transpo:** CUF009

APPLICATION / APLICACIÓN:
SUZUKI: Alto MKS 2004>2008, Baleno 1995>2002, Swift 1.5 05>, Jimny 1.3 16V 01>, Balend 1.3 16V 97>02, Carry 1.3 99>, Esteem 1999>2002;

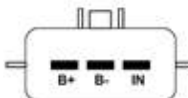
FIAT: Sedici 1.6 2006>;

SUBARU: Justy 2003>

SUZUKI
GC4426
FEATURES / CARACTERÍSTICAS: 3 PIN / WITH IGNITION MODULE

REPLACES / REEMPLAZA:
Suzuki: 33400-83E10, 33400-62J00, 33410-66D00, 33410-66D10; **Chevrolet:** 30020581, 88921408; **Standard:** UF-268; **Transpo:** CUF268, CUF2810; **Regitar:** RUF268; **Mobiletron:** CJ-01; **MEAT&DORIA:** 10512

APPLICATION / APLICACIÓN:
SUZUKI: Alto MKS 2004>2008, Baleno 1995>2002, Swift 1.5 05>, Jimny 1.3 16V 01>, Balend 1.3 16V 97>02, Carry 1.3 99>, Esteem 1999>2002;

FIAT: Sedici 1.6 2006>;

SUBARU: Justy 2003> **CHEVY:** Metro 1999>2001, Tracker 1999>2000;

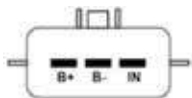
SUZUKI: Swift1.3 1999>2001, Vitara 1.6 1999>2001, Baleno hatch 1.3/1.6 1995>2002, Carry Van 1.3 1999>, Ignis Mk1 1.3 2000>2003, Jimny 1.3 16v 1998>, Liana Saloon/Estate 1.3 2002>

SUZUKI
GC4611 // NEW //
FEATURES / CARACTERÍSTICAS: 3 PIN

REPLACES / REEMPLAZA:
Suzuki: 3340050F20, 3340076G00, 3340076G01, 3340076G11, 3340076G20, 3340076G21, 3340076G30, 3340081A00; **MEAT & DORIA:** 10728; **BREMI:** 20576; **ERA:** 880349

APPLICATION / APLICACIÓN:
SUZUKI: Alto Mk3 Hatch 1.0 1994>1998, Alto 1.0 2000>2002, Wagon R+ 1.0 1998>2000

SUZUKI
GC4711 // NEW //
FEATURES / CARACTERÍSTICAS: 2 PIN / WITHOUT IGNITION MODULE

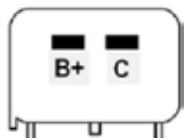
REPLACES / REEMPLAZA:
Suzuki: 33410-77E10, 33410-77E11; **Transpo:** CUF169; **Bremi:** 20150; **Meat & Doria:** 10440; **Mobiletron:** CU-02; **Regitar:** RUF169

APPLICATION / APLICACIÓN:
SUZUKI: Baleno hatch/saloon 1.8 GTX 1996>2002, Baleno estate 1.8i 16V 1996>2002, Vitara 2.0 V6 24V 1994>1998

TOYOTA
GC4028
FEATURES / CARACTERÍSTICAS: 3 TERMINALS / WITHOUT IGNITION MODULE

REPLACES / REEMPLAZA:
TOYOTA 90919-02163; **GM:** 94855502; **LUCAS:** DMB949; **BOSCH:** F000ZS0121; **ROOTS:** 0880016; **Mobiletron:** CT-08; **Magneti Marelli:** BAEQ025; **Standard:** UF111; **Regitar:** RUF111

APPLICATION / APLICACIÓN:
TOYOTA: Camry 2.2 92-95, Rav 4 2.0 16V 96>, Corolla 95-97

TOYOTA
GC4112
FEATURES / CARACTERÍSTICAS: 2 PIN / WITHOUT IGNITION MODULE

REPLACES / REEMPLAZA:
TOYOTA: 29700-4790, 90919-02106

Standard: UF12

Wells: C865

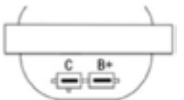
APPLICATION / APLICACIÓN:
TOYOTA: Hilux V Pickup 2.4 i 4WD 1989>1997, Land Cruiser 2.4 1984>1993, Celica Supra Coupe 2.8 1981>1985

TOYOTA
GC4135
FEATURES / CARACTERÍSTICAS: 2 PIN / WITHOU IGNITION MODULE

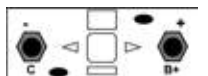
REPLACES / REEMPLAZA:
Toyota: 90919-02135, 90919-02139, 90919-02196, 90919-02152; **VW:** J9091902139; **Standard:** UF40; **Mobiletron:** CT-13; **Regitar:** RUF40

APPLICATION / APLICACIÓN:
CHEVROLET: Nova 85>88, Geo Prizm 90>92; **TOYOTA:** Camry 83>91, Celica 86>93, Celica Coupe 1989>1994, VAN 84>89, VAN Wagon 1988, Carina II 1987>1993, Carina II Saloon 1987>1993, Carina II Station Wagon 1987>1992, Corolla 1983>1989, Corolla 1987>1994, Corolla 1.6 i Saloon 89>93, Corolla Compact 1987>1995, Corolla Compact 1.6 i Hatchback 89>92, Corolla Liftback 1983>1989, Corolla Liftback 1.6 Hatchback 85>87, Corolla Liftback 1987>1995, Corolla Liftback 1.6 Hatchback 89>92, Corolla Station Wagon 1987>1992, Corolla Station Wagon 1.6 Estate 89>92, Hilux II Pickup 1982>2005, Hilux II Pickup 1.8, Pickup 88>94, Hilux II Pickup 2.2 4WD Pickup 87>89, Liteace Box 1992>1995, Liteace Box 2.2 Box 92>95, Liteace Bus 1992>1998, Liteace Bus 2.2 Bus 92>95, Modell F Bus 1982>1990, Modell F Bus 2.0 Bus 88>90, Modell F Bus 2.2 Bus 87>90, Tercel 1982>1988, Tercel 1.5 4WD Hatchback 86>88; **VOLKSWAGEN:** Taro 1989>04 - 1997>03, Taro 1.8 Pickup 89>94, Taro 2.2 Pickup 89>94.

TOYOTA
GC4171

FEATURES / CARACTERÍSTICAS: 2 PIN / WITHOUT IGNITION MODULE

REPLACES / REEMPLAZA:

TOYOTA: 90919-02185, 90919-02185T; **WELLS:** C909; **MEAT & DORIA:** 10540; **STANDARD:** UF71; **MOBILETRON:** CT-06
REGITAR: RUF71; **NGK:** U1091; **TRANSPO:** CUF71

APPLICATION / APLICACIÓN:

LEXUS: Es 250 1989>1991

TOYOTA: Camry Saloon 2.5 V6 GXI 1988>1991, Camry Estate 2.5 1990>1991, Land Cruiser 80-Series 4.0 1990>1992, MR2 Mk2 2.0 16V 1889>1999, 4 Runner 3.0 1990>1995

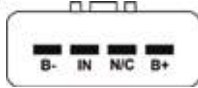
TOYOTA
GC4024

FEATURES / CARACTERÍSTICAS: 4 PIN / WITH IGNITION MODULE

REPLACES / REEMPLAZA:

TOYOTA: 90919-02240, 90080-19021, 90919-T2003; **LUCAS:** DMB902; **STANDARD:** UF-316; **Mobiletron:** CT-24; **Magneti Marelli:** BAEQ078; **Regitar:** RUF316; **Transpo:** CUF316

APPLICATION / APLICACIÓN:

TOYOTA: Corolla / Fielder 01-06, Prius 1.5 00>09, Yaris 99>11

TOYOTA
GC4234 // NEW //

FEATURES / CARACTERÍSTICAS: 4 PIN

REPLACES / REEMPLAZA:

TOYOTA: 19080-46020, 90080-19016, 90919-02207, 90919-02234; **STARK:** SKCO-0070326

APPLICATION / APLICACIÓN:

LEXUS: Es 300 1991>1997, Gs 300 1993>1997, Rx 300 Awd 2000>2003, Rx 300 2003>2008;

TOYOTA: Camry 3.0 1991>1996, Camry 3.0 24V 1996>2001, Camry 3.0 V6 1996>2001, Camry Sw 3.0 1991>1996, Camry Sedan 3.0 2001>2006

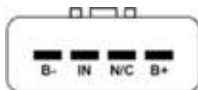
TOYOTA
GC4236

FEATURES / CARACTERÍSTICAS: 4 PIN / WITH IGNITION MODULE

REPLACES / REEMPLAZA:

TOYOTA: 90919-02236

APPLICATION / APLICACIÓN:

TOYOTA: SXE10 Altezza

LEXUS: IS300

TOYOTA
GC4238 // NEW //

FEATURES / CARACTERÍSTICAS:

REPLACES / REEMPLAZA:

Denso: 90919-02238; **MOBILETRON:** CT-41; **MEAT & DORIA:** 10560

APPLICATION / APLICACIÓN:

TOYOTA: Celica 2000>2005, Corolla 2000>2002

TOYOTA
GC4248

FEATURES / CARACTERÍSTICAS: WITH IGNITION MODULE

REPLACES / REEMPLAZA:

TOYOTA: 90919-T2001, 90919-A2001, 90919-02248, 90919-T2008, 90919-02247, 90919-02260, 90919-A2006, 90919-C2002;

TRANSPO: CUF495; **MOBILETRON:** CT-38

APPLICATION / APLICACIÓN:

TOYOTA: 4Runner 03>08, Camry 06>08, FJ Cruiser 07>08, Solara 07>08, Tacoma 05>08, Tundra 05>08

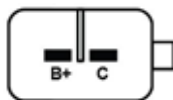
TOYOTA
GC4253

FEATURES / CARACTERÍSTICAS: 2 PIN / WITHOUT IGNITION MODULE

REPLACES / REEMPLAZA:

TOYOTA: 90919-02215, EZX-147A, 88921336, 9008019012, E588; **Standard:** UF-155; **Wells:** C1040; **Magneti Marelli:**

BAEQ118; **Regitar:** RUF155; **Transpo:** CUF155

APPLICATION / APLICACIÓN:

TOYOTA: Camry 95, Solara, Avalon

TOYOTA



GC4500 // NEW //

FEATURES / CARACTERÍSTICAS: 3 PIN

REPLACES / REEMPLAZA:

TOYOTA: 19500-87101; **TRANSPO:** CUF2161; **MOBILETRON:** CT-21; **MEAT & DORIA:** 10694

APPLICATION / APLICACIÓN:

DAIHATSU: Terios 1.3 i SX 4WD 1997>2000

TOYOTA



GC4592 // NEW //

FEATURES / CARACTERÍSTICAS: 4 PIN

REPLACES / REEMPLAZA:

TOYOTA: 90919-T2010

APPLICATION / APLICACIÓN:

TOYOTA: Camry 2.5, 3.5 2018, Highlander 3.5 2017>2018, Sienna 3.5 2017>2018, Camry 2.5 2017>2018

TOYOTA



GC4701

FEATURES / CARACTERÍSTICAS: 4 PIN / WITH IGNITION MODULE

REPLACES / REEMPLAZA:

TOYOTA: 19070-B1011

APPLICATION / APLICACIÓN:

TOYOTA: Avanza Mini Cargo 1.5 2016, Cargo Mini Cargo Van 1.5 2016->, Base Mini Passenger 1.5 2010>2012

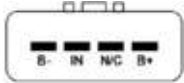

TOYOTA



GC4878 // NEW //

FEATURES / CARACTERÍSTICAS:

REPLACES / REEMPLAZA:

TOYOTA: 90919-02230, 90080-19027; **HITACHI:** 133878, 2503878; **BREMI:** 20396; **CARGO:** 150655; **MEAT & DORIA:** 10558; **MOBILETRON:** CT-36; **TRANSPO:** CUF230

APPLICATION / APLICACIÓN:

LEXUS: GS 430 2000>2004, IS i 200/300 1999>2005, LS 430 2000>2006, LX 470 1998>2008, SC Cabriolet 430 2001>2010;

TOYOTA: LAND CRUIZER 4.7 1998>2007

TOYOTA



GC4952 // NEW //

FEATURES / CARACTERÍSTICAS:

REPLACES / REEMPLAZA:

TOYOTA: 90919-02212; **DENSO:** 029700-7952

APPLICATION / APLICACIÓN:

TOYOTA: Land Cruiser 3.4 24 V 1996>2002 Petrol

UNIVERSAL



GC4018

FEATURES / CARACTERÍSTICAS: 3 TERMINALS / WITHOUT IGNITION MODULE

REPLACES / REEMPLAZA:

Universal (replaces all coils by oil); **Suzuki:** 33410-85120, MIC-2000, FTM-063GTGC-5; **Toyota:** GC-5; **Diamond:** F-076;

Mobiletron: CG-18; **Regitar:** RUF500

APPLICATION / APLICACIÓN:

HYUNDAI;

SUZUKI;

VW;

FORD;

FIAT

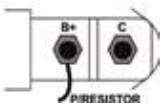

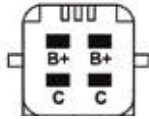
VALEO
GC4064

FEATURES / CARACTERÍSTICAS: 4 PIN / 2 POLARIZERS / WITHOUT IGNITION MODULE

REPLACES / REEMPLAZA:
Valeo: 245098, 2526118, 2526118A; **Peugeot/Citroën:** 597098, 597075, 94632641, 96341314, 96632641, 9634131480; **Fiat:** 9663264180, 9634131380, 9634131490; **Lucas:** DMB866; **Beru:** 0040100348; **Mobiletron:** CE-78; **Magneti Marelli:** BAEQ104, BI0111MM; **Standard:** UF692; **Regitar:** RCE78

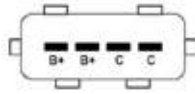
APPLICATION / APLICACIÓN:
CITROËN: C4 2.0 16V, C5 1.8 16V /2.0 16V, C8 2.0 16V, Evasion 2.0 16V, Xsara 2.0 16V, Xsara Picasso 1.8 16V 2005 /2.0 16V 2005; **PEUGEOT:** 307 2.0 16V 2005, 406 1.8 16V /2.0 16V, 407 1.8 16V /2.0 16V, 807 1.8 16V /2.0 16V

VALEO
GC4073 // NEW //

FEATURES / CARACTERÍSTICAS: 4 PIN / WITHOUT IGNITION MODULE

REPLACES / REEMPLAZA:
Valeo: 245099; **Hitachi:** 133821; **Peugeot/Citroën:** 5970-A4, 5970A4, 5970-73, 597073; **Transpo:** CUF052; **NGK:** 48051; **Bremi:** 20340; **Beru:** ZS349; **Mobiletron:** CE-80; **Regitar:** RCE80; **Meat & Doria:** 10417

APPLICATION / APLICACIÓN:
CITROËN: Synergie MPV 2.0 16V 1998>2000, Xantia Mk1 hatch/estate 1.8/2.0i 16v 1993>1998, Xantia Mk2 hatch/estate 1.8/2.0i 16v 1998>2003, XM Mk2 hatch/estate 2.0i 16v 1994>2000, Xsara hatch/estate/coupe/picasso 1.8/2.0i 16v 1997>2000, ZX hatch/estate 1.8/2.0i 16v 1992>1997;

PEUGEOT: 206 hatch 2.0 S16 1999->, 206 SW estate 2.0 16v 2002>2007, 306 hatch/saloon/estate/convertible 1.8/2.0 16v 1997>2001, 307 hatch/estate 2.0 16v 2000->, 307 SW estate 2.0 16v 2002->, 307 CC convertible 2.0 16v 2003->, 406 saloon/estate/coupe 1.8/2.0 16v 1995>2004, 407 saloon 2.0 2004->, 605 saloon 2.0 16v 1994>1999, 607 saloon 2.0 2000>2005, 806/807 2.0 16v 1998>2002, Expert MPV/Van 2.0 2002>2006;

LANCIA: Zeta 2.0 16v 1998>2000

VALEO
GC4084 // NEW //

FEATURES / CARACTERÍSTICAS: WITHOUT IGNITION MODULE

REPLACES / REEMPLAZA:
Valeo: 245100, 2 526 131; **Hitachi:** 133843; **Peugeot/Citroën:** 5970A5, 597076, 597084; **Transpo:** CUF054; **Mobiletron:** CE-106; **Regitar:** RCE106; **Meat & Doria:** 10419; **Beru:** ZS351; **Bremi:** ZS351; **ERA:** 880087

APPLICATION / APLICACIÓN:
CITROËN: C4 hatch 2.0 16v 2004>2008, C4 coupe 2.0 16v 2004>2010, C8 MPV 2.0/2.2 2002>;

PEUGEOT: 206 hatch 2.0 2003>, 307 hatch/estate 2.0 16v 2005>, 307 CC convertible 2.0 16v 2003>, 406 saloon/estate/coupe 2.2 2000>2004, 407 saloon 1.8/2.2 2004>, 407 SW estate 1.8/2.2 2004>, 407 coupe 2.2 16v 2005>, 607 saloon 2.2 16v 2000>2010, 807 MPV 2.2 2002>

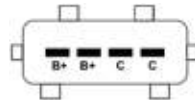
VALEO
GC4099

FEATURES / CARACTERÍSTICAS: 4 PIN / WITHOUT IGNITION MODULE

REPLACES / REEMPLAZA:
Valeo: 245046; **Peugeot:** 597051, 5970A5; **Citroën:** 96211048; **Sagem:** 2526059A

APPLICATION / APLICACIÓN:
CITROËN: Evasion, Xantia X1, Xantia Break, Xsara Break, Xsara Coupé, Xsara Picasso, ZX, ZX Break;

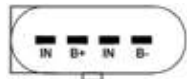
PEUGEOT: 306, 306 Break, 306 Cabriolet, 406, 406 Break, 406 Coupé, 605

VALEO
GC4199 // NEW //

FEATURES / CARACTERÍSTICAS: 4 PIN / WITH IGNITION MODULE

REPLACES / REEMPLAZA:
Valeo: 245137; **Bosch:** 0 986 221 099; **VW/Seat/Skoda:** 047905104A, 047905104B; **Beru:** ZSE040; **Bremi:** 20450; **Transpo:** CUF049; **Regitar:** RCE113; **Mobiletron:** CE113; **Meat & Doria:** 10333

APPLICATION / APLICACIÓN:
VOLKSWAGEN: Lupo Hatch 1.0 1998>2000;

SEAT: Arosa hatch 1.0 1998>2001;

SKODA: Fabia Mk1 hatch 1.0/1.4 1999>2003, Fabia Mk1 saloon/estate 1.4 2000>2003, Fabia Mk1 van 1.4 2001>2003

VALEO
GC4580

FEATURES / CARACTERÍSTICAS: 6 PIN / WITHOUT IGNITION MODULE

REPLACES / REEMPLAZA:
Valeo: 9800251580, 9674680380

APPLICATION / APLICACIÓN:
CITROËN: Elysse 12>;

HYUNDAI: Accent 94>00, Elantra 95>00;

PEUGEOT: 301 12>, 308 II 13>

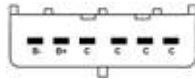
VALEO
GC4780

FEATURES / CARACTERÍSTICAS: 6 PIN / WITHOUT IGNITION MODULE

REPLACES / REEMPLAZA:
Valeo: 9656695780; **Citroën:** 21597716-4, 597087, 597092; **Bougiacord:** 155040; **Mobiletron:** CE-105; **Regitar:** RCE105

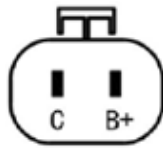
APPLICATION / APLICACIÓN:
PEUGEOT: 307 2000>, 407 2004>, 807 2002>, Expert 2007>;
CITROËN: C4 2004>, C4 Xsara 2007>2013, C5 2008>, C8 2002>

VALEO
GC4032 // NEW //

FEATURES / CARACTERÍSTICAS: 3 PIN / WITHOUT IGNITION MODULE

REPLACES / REEMPLAZA:
Valeo: 245224; **Bosch:** 0 986 221 032; **Ford:** F3XA12029AA, F3XY12026A; **Nissan:** 22433-0B00, 224330B00, 22433-0B000, 224330B000, 22433-51J10, 2243351J10, 22433-53J20, 2243353J20, 22433-55S10, 2243355S10, 22433-56E11, 2243356E11; **FORD:** F3XA12029AA, F3XY12029A, F5XZ12029AA, 1953302, 1953306; **Transpo:** CUF38; **Mobiletron:** CF10; **Regitar:** RUF38; **Meat & Doria:** 10423

APPLICATION / APLICACIÓN:
NISSAN: 100 NX 1.6 1990>1994, 200SX 2.0i 16v turbo 1993>1999, 300ZX 3.0 1984>1987, Almera hatch/saloon 1.4/1.6/2.0 1995>2000, Bluebird saloon/estate/hatch 2.0i 1984>1988, Maxima Mk3 3.0i 1988>1994, Pickup 2.4 12v 1992>1998, Primera Mk1 hatch 1.6/2.0 1990>1996, Serena 1.6/2.0 1992>2001, Sunny Mk2 hatch/saloon/estate/coupe 1.6i 1986>1990, Terrano 3.0i 4WD 1990>1995, Vanette cargo minibus 1.6i 1996>2001;

FORD: Maverick Mk1 2.4i 1993>1998;

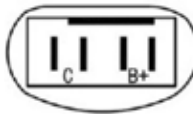
INFINITI: M30 Coupe 3.0 1989>1993

VALEO
GC4214 // NEW //

FEATURES / CARACTERÍSTICAS: 4 PIN / WITHOUT IGNITION MODULE

REPLACES / REEMPLAZA:
Valeo: 245027; **Bosch:** F 000 ZS0 114; **Citroën/ Peugeot:** 597043, 97530780; **Mobiletron:** CE04; **Regitar:** RUF304; **Meat & Doria:** 10476; **Beru:** ZS247; **Bremi:** 11878; **Transpo:** CUF1016

APPLICATION / APLICACIÓN:
CITROËN: AX 10E 1986>1988, BX hatch 11 1988>1992, BX estate 1.4 1987>1992, C15 Van 1.1/1.4 1984>1996, C15 Kombi 1.1/1.4 1987>1996;

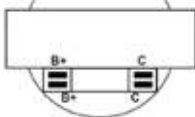
PEUGEOT: 205 Mk1 cabrio 1.1/1.4/1.9 1987>1994, 205 Mk2 hatch 1.0/1.1/1.4/1.9 1987>1998, 205 van 1.1 1987>1990, 309 Mk1 / Mk2 hatch 1.4 1988>1989, 405 Mk1 saloon/estate 1.9 1987>1992

VALEO
GC4232 // NEW //

FEATURES / CARACTERÍSTICAS: 2 PIN / WITHOUT IGNITION MODULE

REPLACES / REEMPLAZA:
Valeo: 245043; **Bosch:** F 000 ZS0 112; **Opel:** 01208002, 01208004, 01208036, 01208048, 1208002, 1208004, 1208036, 1208048; **Meat & Doria:** 10477; **Beru:** ZS252; **Bremi:** 11896; **Mobiletron:** CE-02; **Regitar:** RUF301; **Transpo:** CUF1010

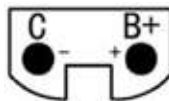
APPLICATION / APLICACIÓN:
OPEL: Ascona C Hatch 1.6i 1987>1988, Ascona C saloon 1.3 1981>1988, Ascona F hatch/saloon/estate/van 1.6 1991>1998, Corsa A hatch 1.2/1.3/1.6 1982>1993, Corsa A van 1.2/1.3 1986>1990, Kadett hatchback 1.3/1.6 1984>1991, Vectra A hatch 1.6 1988>1995

VALEO
GC4245 // NEW //

FEATURES / CARACTERÍSTICAS: WITHOUT IGNITION MODULE

REPLACES / REEMPLAZA:
Valeo: 245064; **Audi:** 211905115D, 811905115; **BMW:** 12131273216; **Seat:** 211905115D; **VW:** 191905115A, 211905115D; **Bremi:** 11906; **ERA:** 880030

APPLICATION / APLICACIÓN:
SEAT: Toledo Mk1 Hatch 1.8 16V 1991>1999;

VOLKSWAGEN: Caddy pickup 1.8 1985>1992, Corrado 1.8 1988>1993, Jetta Mk2 saloon 1.3/1.6/1.8 1984>1991, Santana 1.6/1.8 1981>1984, Scirocco Mk2 coupe 1.8 1982>1992;

AUDI: 80 Mk2 saloon 1.3/1.6/1.8 1978>1986, Coupe 1.8 GT/2.0/2.2 GT 1981>1988, 90 Mk1 saloon 2.0/2.2 1984>1987;

BMW: 315/316//318/320/323 1978>1984, 518 1974>1981, 628 CSi 1979>1987, 728 1977>1986

VALEO

GC4630 // NEW //



FEATURES / CARACTERÍSTICAS:

REPLACES / REEMPLAZA:

Valeo: 245130; **DELPHI:** GN10196-12B1; **HITACHI:** 138877, 2508877

APPLICATION / APLICACIÓN:

LAND ROVER: Freelander 1.8 16V 4X4 1998>2006, Freelander 1.8 16V 4X4 1998>2000, Freelander Soft Top 1.8 16V 4X4 1998>2006
MG: Mgf 1.8 16V 1995>2002, 200 Convertible 216 1.6 16V 1996>1999, 200 CoupÉ 216 1992>1999, 200 Hatch 211 1998>2000, 200 Hatch 214 Si 1995>2000, 200 Hatch 214 1995>2000, 200 Hatch 216 Si 1995>1999, 25 Hatch 1.1 16V 2004>2005, 25 Hatch 1.8 16V 1999>2005, 400 414 Si 1995>2000, 400 Hatch 414 Si 1995>2000, Coupe 1.6 16V 1996>1999

VALEO

GC4250



FEATURES / CARACTERÍSTICAS: 4 PIN / WITHOUT IGNITION MODULE

REPLACES / REEMPLAZA:

Valeo: 245057, 90458250; **Vauxhall:** 90458250

APPLICATION / APLICACIÓN:

OPEL: Astra F CC, Astra F, Astra F Caravan, Astra F Cabriolet, Astra G Stufenheck, Astra G Caravan, Ômega B Caravan, Vectra A CC, Vectra B Caravan, Zafira A

VALEO

GC4240 // NEW //

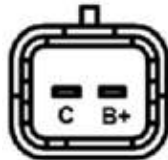

FEATURES / CARACTERÍSTICAS: 2 PIN / WITHOUT IGNITION MODULE

REPLACES / REEMPLAZA:

Valeo: 245094; **Peugeot/ Citroën:** 5970-77, 597077, 5970-94, 597094; **Fiat:** 9633001580, 9664401880; **Renault/ Lancia:** 7701479027, 9633001580, 9664401880; **Transpo:** CUF059; **Mobiletron:** CE77; **Regitar:** RCE77; **Meat & Doria:** 10418, 10550; **Bremi:** 20306; **ERA:** 880095

APPLICATION / APLICACIÓN:

CITROËN: C5 Mk1 hatch/ estate 3.0 V6 2001>2004, C5 Mk1 estate 3.0 Carlsson 2003>2004, C5 Mk2 hatch/ estate 3.0 V6 2004>, C5 Mk3 hatch/ estate 3.0 V6 2008>, C6 saloon 3.0 V6 2005>, C8 MPV 3.0 V6 2002>;

PEUGEOT: 406 saloon/ estate/ coupe 3.0 V6 2000>2004, 406 coupe 3.0 V6 24V 1997>2004, 407 saloon 3.0 2004>, 407 SW estate 3.0 2004>, 407 coupe 3.0 V6 2005>, 607 saloon 3.0 V6 24V 2000>2011, 807 MPV 3.0 V6 2002>;

FIAT: Ulysse Mk2 3.0 2002>2011;

LANCIA: Phedra 3.0 V6 2002>2010;

RENAULT: Avantage 3.0 V6 2001>2003, Clio Mk2 hatch 3.0 V6 Sport 2000>2002, Laguna Mk2 hatch/ estate 3.0 V6 24V 2001>2007

VW

GC4046

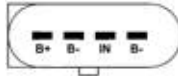

FEATURES / CARACTERÍSTICAS: 4 PIN / WITH IGNITION MODULE

REPLACES / REEMPLAZA:

VW/ Audi: 06B905115E, 06B905115, 06B905105, 06B905115B; **Hitachi:** CMIT-201; **Lucas:** DMB820; **Magneti Marelli:** BI0037MM; **Bremi:** 20130; **Era:** 880037; **Meat&Doria:** 10330; **Mobiletron:** CE-102; **Transpo:** CUF274

APPLICATION / APLICACIÓN:

AUDI: A3, A4 Cabriolet, A6, A6 Avant, A8, TT, TT Roadster;

VW: Golf IV, Golf IV Variant, New Beetle, New Beetle Cabriolet, Sharan, Touareg

VW

GC4058

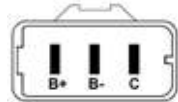

FEATURES / CARACTERÍSTICAS: 3 PIN / WITH IGNITION MODULE

REPLACES / REEMPLAZA:

VW/ AUDI: 058 905 105, 058905101; **SEAT/ SKODA:** 058905105; **LUCAS:** DMB403; **BREMI:** 11869; **BOSCH:** 0986221011; **BERU:** 0040100013; **Mobiletron:** CE-56; **Regitar:** RUF290

APPLICATION / APLICACIÓN:

AUDI: A3 96>00, A4 96>01, A6 97>01 / A6 AVANT 1.8 T / 2.7 T 97>05, A8 94>03;

VW: Passat 1.8T 96>00

VW

GC4098

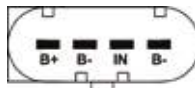

FEATURES / CARACTERÍSTICAS: 4 PIN / WITH IGNITION MODULE

REPLACES / REEMPLAZA:

VW: 030 915 110 B; **Mobiletron:** CE-172; **Regitar:** RCE172; **Magneti Marelli:** BI0072MM; **Delphi:** GN10523

APPLICATION / APLICACIÓN:

VW: Gol VI, Novo Fox, Voyage G6, Saveiro G6

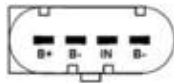
VW
GC4117

FEATURES / CARACTERÍSTICAS: 4 PIN / WITH IGNITION MODULE

REPLACES / REEMPLAZA:
VW: 06H905199A, 06L905110B, 06L905110C, 06L905110D, 06H905110E, 06H905110G; **TRANSPO:** CUF2102;

MEAT&DORIA: 10620

APPLICATION / APLICACIÓN:
AUDI: A1/A1 Sportback 1.8 TFSI/S1 quattro 2010>, A3/A3 Sportback/A3 Limousine/A3 Convertible 1.8 TFSI/1.8 TFSI quattro/2.0 TFSI/2.0 TFSI quattro/S3 quattro 2012>, A4 MK 4 SALOON/AVANT/ESTATE 1.8 TFSI/1.8 TFSI quattro/2.0 TFSI/2.0 TFSI quattro 2007>2015, A4 Allroad 2.0 TFSI quattro 2009>, A4/A4 Avant 2.0 TFSI/2.0 TFSI quattro/S4 quattro 2015>, A5 COUPE/A5 Sportback/A5 Convertible 1.8 TFSI/2.0 TFSI/2.0 TFSI quattro 2007>2017, A5 2.0 TFSI/2.0 TFSI quattro/S5 quattro 2016>, A5 Sportback 2.0 TFSI quattro/S5 quattro 2016>, A6/A6 Avant/A7 Sportback 1.8 TFSI/2.0 TFSI/2.0 TFSI quattro 2010>, A8 2.0 TFSI quattro 2009>, Q3 2.0 TFSI/2.0 TFSI quattro 2011>, Q5/Q7 2.0 TFSI quattro 2008>, TT/TT Roadster 1.8 TFSI/2.0 TFSI/2.0 TFSI quattro/2.5 RS quattro 2014->

PORSCHE: Macan 2.0 2014>, Panamera 2.9 4S/4.0 Turbo

SEAT: Alhambra 2.0 TSI 2010>, Leon/Leon SC 1.8 TSI/2.0 Cupra 2012>, Leon ST 1.8 TSI/1.8 TSI 4 Drive/2.0 Cupra 2013>

SKODA: Octavia/Octavia Combi 1.8 TSI/1.8 TSI 4x4/2.0 TSI RS 2012>, SuperB/SuperB Estate 1.8 TSI/2.0 TSI/2.0 TSI 4x4

VW: Beetle/Beetle Convertible/Jetta IV/Scirocco MK 3 Coupe/Sharan 2.0 TSI 2008>, Golf VII 2.0 GTI/2.0 GTI Clubsport / 2.0 R 4motion 2012>, Golf VII Estate 2.0 R 4motion 2013>, Golf VI Convertible 2.0 TSI 2011> Golf Alltrack 1.8 TSI 4motion 2014>, Passat/Passat Variant 1.8 TSI/2.0 TSI/2.0 TSI 4motion 2014>, Passat Alltrack/Tiguan 2.0 TSI 4motion 2015>, Polo 1.8 GTI 2009>, Touran 1.8 TSI 2015>

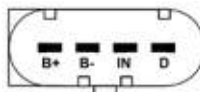
VW
GC4118

FEATURES / CARACTERÍSTICAS: 4 PIN / WITH IGNITION MODULE

REPLACES / REEMPLAZA:
VW: 04E 905 110 E, 04E 905 110M; **Eldor:** 7730012; **Mobiletron:** CE-173; **Magneti Marelli:** BI0078MM; **Bosch:** 0 986 221 057

APPLICATION / APLICACIÓN:
VW: GOLF TSI 1.4 2014>, Up turb 2016;

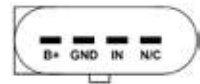
AUDI: A3 1.4 TSI 2014>

VW
GC4160

FEATURES / CARACTERÍSTICAS: 4 PIN / WITH IGNITION MODULE

REPLACES / REEMPLAZA:
VW: 06K905110K; **Mobiletron:** CE-174

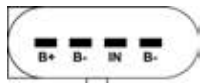
APPLICATION / APLICACIÓN:
VW: New Beetle 2013>, Passat 2016>, Jetta 2015>, Golf, Variant 2013>

VW
GC4215

FEATURES / CARACTERÍSTICAS: 4 PIN / WITH IGNITION MODULE

REPLACES / REEMPLAZA:
VW / Audi: 06F905115, 06F905115A/B/C/D/E/F, 07K905715, 07K905715A/B/C/D/E/F, 06H905115, 06H905115A/B/, 0221604115;

Mobiletron: CE-143; **Magneti Marelli:** BAEQ108, BI0116MM; **Standard:** UF575; **Regitar:** RUF575; **Era:** 880064; **Transpo:** CUF575

APPLICATION / APLICACIÓN:
VW: Passat, Jetta 2.0 FSI, Jetta Variant 1.8/2.0 2005>2010, Tiguan 2.0 2007>, Touareg 4.2 V8 FSI 2006>, Golf V;

Audi: A3, A4, A5, A6, R8, TT, Q5, Q7 TSFI;

Seat: Toledo III

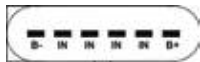
VW
GC4097

FEATURES / CARACTERÍSTICAS: 6 PIN / WITH IGNITION MODULE

REPLACES / REEMPLAZA:
VW / SKODA: 06A 905 097, 06A 905 104, 06A905097, 0040102029, 905100004; **Mobiletron:** CE-64; **Standard:** UF484; **Regitar:** RUF484; **Magneti Marelli:** BI0060MM; **Bosch:** 0 986 221 049; **Delphi:** GN10383

APPLICATION / APLICACIÓN:
VW AUDI: Bora 2.0I 98>05, Golf IV 2.0I 98>06, New Beetle 2.0I 98>10, Touran 06>09;

Santana 3000, Voyage /Saveiro /Gol 1.0 VHT G5 2010>;

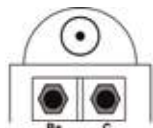
SKODA: Octavia 2.0I

VW / FORD
GC4104

FEATURES / CARACTERÍSTICAS: 2 PIN / WITHOUT IGNITION MODULE

REPLACES / REEMPLAZA:
VW: 867.905.104-A, 6N0905104; **Bosch:** 0221601005, 0 986 221 000; **Mobiletron:** CE-01; **Magneti Marelli:** BAEQ006;

Regitar: RUF104S

APPLICATION / APLICACIÓN:
VW: Golf III 1.8, 2.0 94- 98, Polo Classic 1.6, 1.8 Mi 98-03

VW / FORD
GC4105
FEATURES / CARACTERÍSTICAS: 2 PIN / WITHOUT IGNITION MODULE

REPLACES / REEMPLAZA:
VW: 547.905.105B; **Bosch:** F000ZS0102; **Mobiletron:** CE-116; **Regitar:** RCE116

APPLICATION / APLICACIÓN:
FORD: Escort 1.6, 1.8 2.0 XR3, 94-96, Pampa 1.896-97, Versailles/ Royale, 97-96, Verona 1.8i, 2.0i 94-96;

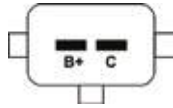
VW: Gol II 1.0, 1.6, 1.8, 2.0, 94-97, Logus 1.6, 1.8, 2.0, 94-96, Parati II 1.6, 1.8, 2.0, 95-96, Pointer, 1.8, 2.0 94-96, Santana/ Quantum 2.0, 94-96

VW / FORD
GC4002
FEATURES / CARACTERÍSTICAS: 6 PIN / WITH IGNITION MODULE

REPLACES / REEMPLAZA:
Bosch: 0 221 601 002; **Magneti Marelli:** BI0018MM; **VW:** 54.790.510.4B, 867 905 105 A; **Mobiletron:** IG-H012K; **Regitar:** H013K-1

APPLICATION / APLICACIÓN:
FORD: Escort, Verona;

VW: Gol 1000, Passat, Voyage 1.6, 1.8



EMS COMPONENTS | SISTEMA DE CONTROL DE MOTOR

IGNITION CABLE | CABO DE IGNICIÓN

GC5000 // NEW //

FEATURES/ CARACTERISTICAS:

PS: With resistive cable

REPLACES / REEMPLAZA:
Bosch: F 000 99C 058; **NGK:** SC-T54

APPLICATION / APLICACIÓN:
FIAT: Fiorino Furgão/ Pick-up/ Strada 1.5 MPI Gasoline/Alcohol/GNV 97>04, Palio/ Weekend/ Siena/ Strada 1.0/1.5 MPI 8V Gasoline/Alcohol/GNV 96>04, Uno/ Furgoneto 1.3/1.5 Gasoline/Alcohol/GNV 97>03

GC5001 // NEW //

FEATURES/ CARACTERISTICAS:

PS: With resistive cable

REPLACES / REEMPLAZA:
Bosch: F 000 99C 063; F 000 99C 064; 9 295 080 061; SC-F01

APPLICATION / APLICACIÓN:
FORD: Courier 1.3/ Endura Gasoline/GNV 97>99, Fiesta 1.0/ Endura Gasoline/GNV 96>, Fiesta 1.3/ Endura Gasoline/GNV 96>, Fiesta 1.3 / Espanhol (60 cv) Gasoline/GNV 94>95, Ka 1.0 / 1.3 / Endura Gasoline/GNV 96>

GC5002 // NEW //

FEATURES/ CARACTERISTICAS:

PS: Resistive terminal

REPLACES / REEMPLAZA:
Bosch: F 000 99C 081; **NGK:** ST-V17

APPLICATION / APLICACIÓN:
VW: Gol/ Special II 1.0Mi 8V Gasoline/Alcohol/GNV 96>05, Gol III 1.0Mi 8V Gasoline/Alcohol/GNV 99>05

GC5003 // NEW //

FEATURES/ CARACTERISTICAS:

PS: Resistive terminal

REPLACES / REEMPLAZA:
Bosch: F 000 99C 082; **NGK:** ST-V18

APPLICATION / APLICACIÓN:
SEAT: Cordoba/ Ibiza 1.8 Gasoline/Alcohol/GNV 96>02;

VW: Gol/ Parati/ Saveiro II / III 1.6/1.8/2.0 Mi Gasoline/Alcohol/GNV 96>05, Santana/ Quantum 1.8/2.0 Mi (AP) Gasoline/Alcohol/GNV 96>06

GC5004 // NEW //

FEATURES/ CARACTERISTICAS:

PS: With resistive cable

REPLACES / REEMPLAZA:
Bosch: F 000 99C 110; **NGK:** SC-T06

APPLICATION / APLICACIÓN:
FIAT: Palio/ Weekend/ Siena/ Uno 1.0/1.3 MPI 8V (Fire) Gasoline/Alcohol/GNV 00>06, Fiorino Furgão 1.3 MPI 8V (Fire) Gasoline/Alcohol/GNV 03>08, Strada 1.3 MPI 8V (Fire) Gasoline/Alcohol/GNV 02>05

GC5005 // NEW //

FEATURES/ CARACTERISTICAS:

PS: Resistive terminal

REPLACES / REEMPLAZA:
Bosch: F 000 99C 127; **NGK:** ST-V30

APPLICATION / APLICACIÓN:
VW: Gol/ Parati/ Saveiro III 1.6/1.8Mi Gasoline/Alcohol/GNV 03>05, Gol/ Parati/ Saveiro IV 1.6/1.8 Gasoline/Alcohol/GNV 05>

GC5006 // NEW //

FEATURES/ CARACTERISTICAS:

PS: With resistive cable

REPLACES / REEMPLAZA:
Bosch: F 000 99C 130; **NGK:** SC-T09

APPLICATION / APLICACIÓN:
FIAT: Palio/ Siena 1.0 MPI 8V Gasoline/Alcohol/GNV 03>, Uno Mille Economy 1.0 MPI 8V Gasoline/Alcohol/GNV 09>, Idea/Palio/Punto/Siena/Strada 1.4 Gasoline/Alcohol/GNV 05>, Fiorino Furgão/ Uno Furgoneta 1.3 MPI 8V Gasoline/Alcohol/GNV 07>

**GC5007 // NEW //**

FEATURES/ CARACTERISTICAS:

PS: With resistive cable

REPLACES / REEMPLAZA:

Bosch: F 000 99C 076; **NGK:** SC-F02

APPLICATION / APLICACIÓN:

FORD: Courier 1.6 / Zetec Rocam Gasoline/GNV 1999>, Courier 1.6 / Zetec Rocam Flex (96 cv gas - 107 cv eta) Bifuel/GNV 07>08, Ecosport 1.0 8v / Superchager (Zetec-Rocam) Gasoline/GNV 03>06, Ecosport 1.6 8v / Zetec Rocam (W37) Gasoline/GNV 03>08, Ecosport 1.6 8v / Zetec Rocam Flex (105 cv Gasoline / 111 cv eta. - WFF) Bifuel/GNV 05>08 Escort 1.6 / Zetec Rocam Gasoline/GNV 1995>, Escort 1.6 / Zetec Rocam Ethanol/GNV 00>02, Fiesta 1.0 8v / Zetec Rocam Gasoline/GNV 99>06, Fiesta 1.0 8v / Zetec Rocam Flex (71cv Gasoline/ 73cv eta.) Bifuel/GNV 06>08, Fiesta 1.0 8v / Superchager (Zetec-Rocam) (WCP) Gasoline/GNV 02>07, Fiesta 1.6 8v / Zetec Rocam (W37) Gasoline/GNV 99>08, Fiesta 1.6 8v / Zetec Rocam Flex (WFF) Bifuel/GNV 04->08, Focus 1.6 8v - SOHC / Zetec Rocam (103 cv) Gasoline/GNV 04>, Focus 1.6 8v / Zetec Rocam Flex (105,2 cv gas - 112,6 cv eta.) Bifuel/GNV 07>08, Ka 1.0 / Zetec Rocam Gasoline/GNV 1999>, Ka 1.6 / Zetec Rocam Gasoline/GNV

**GC5008 // NEW //**

FEATURES/ CARACTERISTICAS:

PS: With resistive cable

REPLACES / REEMPLAZA:

Bosch: 9 295 080 016; **NGK:** SC-F29

APPLICATION / APLICACIÓN:

FORD: Belina/ Corcel/ Del Rey/ Pampa 1.3 / 1.4 / 1.6 Gasoline/GNV >83, Belina/ Corcel/ Del Rey/ Pampa 1.3 / 1.4 / 1.6 Ethanol/GNV >83

**GC5009 // NEW //**

FEATURES/ CARACTERISTICAS:

PS: With resistive cable

REPLACES / REEMPLAZA:

Bosch: 9 295 080 032; **NGK:** SC-T46

APPLICATION / APLICACIÓN:

FIAT: Elba/ Prêmio/ Uno 1.5 SPI/1.6 SPI Gasoline/Alcohol/GNV 92>96, Fiorino 1.0/1.5 SPI Gasoline/Alcohol/GNV 94>96, Uno Mille 1.0 SPI / Eletronic 1.0 Gasoline/Alcohol/GNV 93>01

**GC5010 // NEW //**

FEATURES/ CARACTERISTICAS:

PS: Resistive terminal

REPLACES / REEMPLAZA:

Bosch: F 000 99C 125; **NGK:** ST-V25

APPLICATION / APLICACIÓN:

VW: Fox/ Crossfox/ Spacefox 1.0/1.6 Gasoline/Alcohol/GNV 03>, Gol III / IV / V (NF) 1.0/1.6 Gasoline/Alcohol/GNV 01>, Golf IV 1.6 Gasoline/Alcohol/GNV 01>07, Polo / Sedan 1.6 Gasoline/Alcohol/GNV 02>08

**GC5011 // NEW //**

FEATURES/ CARACTERISTICAS:

PS: With resistive cable

REPLACES / REEMPLAZA:

Bosch: F 000 99C 076, F 000 99C 142; **NGK:** SC-F30

APPLICATION / APLICACIÓN:

FORD: Courier 1.6 / Zetec Rocam Gasoline/GNV 99>, Courier 1.6 / Zetec Rocam Flex (96 cv gas - 107 cv eta) Bifuel/GNV 07>08, Courier 1.6 8v / Zetec Rocam Flex (103 cv Gasoline/ 109 cv eta.) Bifuel/GNV 08>, Ecosport 1.0 8v / Superchager (Zetec-Rocam) Gasoline/GNV 03>06, Ecosport 1.6 8v / Zetec Rocam (W37) Gasoline/GNV 03>08 Ecosport 1.6 8v / Zetec Rocam Flex (105 cv Gasoline / 111 cv eta. - WFF) Bifuel/GNV 05>08, Ecosport 1.6 8v / Zetec Rocam Flex (101 cv Gasoline/ 107 cv eta.) Bifuel/GNV 08>, Escort 1.6 / Zetec Rocam Gasoline/GNV 95>, Escort 1.6 / Zetec Rocam Ethanol/GNV 00>02, Fiesta 1.0 8v / Zetec Rocam Gasoline/GNV 99>06, Fiesta 1.0 8v / Zetec Rocam Flex (71cv Gasoline/ 73cv eta.) Bifuel/GNV 06>08, Fiesta 1.0 8v / Zetec Rocam Flex (69cv Gasoline- 73cv eta.) Bifuel/GNV 08>, Fiesta 1.0 8v / Superchager (Zetec-Rocam) (WCP) Gasoline/GNV 02>07, Fiesta 1.6 8v / Zetec Rocam (W37) Gasoline/GNV 99>08, Fiesta 1.6 8v / Zetec Rocam Flex (WFF) Bifuel/GNV 04>08, Fiesta 1.6 8v / Zetec Rocam Flex (101 cv Gasoline / 106,6cv eta. - WFF) Bifuel/GNV 08>, Focus 1.6 8v - SOHC / Zetec Rocam (103 cv) Gasoline/GNV 04>, Focus 1.6 8v / Zetec Rocam Flex (105,2 cv gas - 112,6 cv eta.) Bifuel/GNV 07>08, Focus 1.6 8v / Zetec Rocam Flex (105,2 cv Gasoline / 112,6 cv eta.) Bifuel/GNV 08>, Ka 1.0 / Zetec Rocam Gasoline/GNV 99>, Ka 1.0 8v / Zetec Rocam Flex (70cv Gasoline/ 73cv eta.) Bifuel/ GNV 08>, Ka 1.6 / Zetec Rocam Gasoline/GNV, Ka 1.6 8v / Zetec Rocam Flex (102 cv Gasoline / 110 cv eta.) Bifuel/GNV

**GC5012 // NEW //**

FEATURES/ CARACTERISTICAS:

PS: With resistive cable

REPLACES / REEMPLAZA:

Bosch: 9 295 080 005; **NGK:** SC-G01

APPLICATION / APLICACIÓN:

GM: Ipanema 1.8 / 2.0 - efi (opcional cable) Gasoline/GNV 92>94, Ipanema 1.8 / 2.0 - efi (opcional cable) Ethanol 92>94, Kadett 1.8 / 2.0 - efi (opcional cable) Gasoline/GNV 92>94, Kadett 1.8 / 2.0 - efi (opcional cable) Ethanol 92>94, Monza 1.8 / 2.0 - efi (opcional cable) Gasoline/GNV 92>94, Monza 1.8 / 2.0 - efi (opcional cable) Ethanol 92>94

GC5013 // NEW //

FEATURES/ CARACTERÍSTICAS:

PS: With resistive cable

REPLACES / REEMPLAZA:
Bosch: 9 295 080 002; **NGK:** SC-G61

APPLICATION / APLICACIÓN:
GM: Ipanema 1.8 (carb.) Gasoline/GNV, Ipanema 1.8 (carb.) Ethanol/GNV >96, Ipanema 2.0 - mpfi Gasoline/GNV, Ipanema 2.0 - mpfi Ethanol/GNV >96, Kadett 1.8 - (carb.) Gasoline/GNV Kadett 1.8 - (carb.) Ethanol/GNV >96, Kadett 2.0 - mpfi Gasoline/GNV, Kadett 2.0 - mpfi Ethanol/GNV >96, Monza 1.6 / 1.8 / 2.0 - (carb.) Gasoline/GNV, Monza 1.6 / 1.8 / 2.0 - (carb.) Ethanol/GNV >96, Monza 2.0 - mpfi Gasoline/GNV, Monza 2.0 - mpfi Ethanol/GNV >96

GC5014 // NEW //

FEATURES/ CARACTERÍSTICAS:

PS: With resistive cable

REPLACES / REEMPLAZA:
Bosch: 9 295 080 000; **NGK:** SC-G62

APPLICATION / APLICACIÓN:
GM: Chevette 1.0 / 1.4 / 1.6 Gasoline/GNV/Ethanol, Chevy 1.4 / 1.6 Gasoline/GNV/Ethanol, Marajó 1.4 / 1.6 Gasoline/GNV/Ethanol

GC5015 // NEW //

FEATURES/ CARACTERÍSTICAS:

PS: With resistive cable

REPLACES / REEMPLAZA:
Bosch: 9 295 080 001; **NGK:** SC-G63

APPLICATION / APLICACIÓN:
GM: Caravan / Comodoro 4Cil. (ign. conv. and ign. electr.) Gasoline/GNV/Ethanol, Diplomata 4Cil. (ign. conv. and ign. electr.) Gasoline/GNV/Ethanol, Opala 4Cil. (ign. conv. and ign. electr.) Gasoline/GNV/Ethanol

GC5016 // NEW //

FEATURES/ CARACTERÍSTICAS:

PS: With resistive cable

REPLACES / REEMPLAZA:
Bosch: 9 295 080 004; **NGK:** SC-G64

APPLICATION / APLICACIÓN:
GM: A-10 / A-20 6 Cil. 250 GNV/Ethanol 85>95, Brasinca Blazer 4.1 / 6 Cil. (L30) GNV/Ethanol 85>89; C-10 / C-14 / C-15 6 Cil. 261 Gasoline / GNV Gasoline/ GNV, Caravan / Comodoro 6Cil. (ign. conv./ eletr.) Gasoline/GNV/Ethanol, Diplomata 6 Cil. / (ign. conv./ eletr.) without air conditioning Gasoline/GNV/Ethanol, Opala 6Cil. - ign. conv./ ign. eletr. Gasoline/GNV/Ethanol

GC5017 // NEW //

FEATURES/ CARACTERÍSTICAS:

PS: With resistive cable

REPLACES / REEMPLAZA:
Bosch: 9 295 080 003, 9 295 080 005; **NGK:** SC-G65

APPLICATION / APLICACIÓN:
GM: Ipanema 1.8 / 2.0 - efi Gasoline/GNV/Ethanol 92>, Kadett 1.8 / 2.0 - efi Gasoline/GNV/Ethanol 92>, Monza 1.8 / 2.0 - efi Gasoline/GNV/Ethanol 92>

GC5018 // NEW //

FEATURES/ CARACTERÍSTICAS:

PS: With resistive cable

REPLACES / REEMPLAZA:
Bosch: 9 295 080 010; **NGK:** SC-G66

APPLICATION / APLICACIÓN:
GM: Corsa 1.0 / 1.4 / 1.6 8v efi Gasoline/GNV, Corsa 1.0 / 1.4 / 1.6 8v efi GNV/Ethanol 94>

GC5019 // NEW //**FEATURES/ CARACTERISTICAS:**

PS: With resistive cable

REPLACES / REEMPLAZA:**Bosch:** F 000 99C 012; **NGK:** SC-G73**APPLICATION / APLICACIÓN:**

FIAT: Doblò 1.8 8v Gasoline/GNV 04>, Doblò 1.8 8v / Flex (112 cv Gasoline / 114 cv eta.) Bifuel/GNV 06>, Doblò Adventure 1.8 8v Gasoline/GNV 04>06, Doblò Adventure 1.8 8v / Flex (112 cv Gasoline / 114 cv eta) Bifuel/GNV 06>, Idea 1.8 8v / HLX Flex (112 cv Gasoline / 114 cv eta.) Bifuel/GNV 05>Idea Adventure 1.8 8v / Flex (112 cv Gasoline / 114 cv eta.) Bifuel/GNV 06>, Palio 1.8 8v Gasoline/GNV 03>, Palio 1.8 8v / Flex Bifuel/GNV 04>, Palio 1.8R 8v / Flex (113 cv Gasoline - 115 cv eta.) Bifuel/GNV 05>, Palio Adventure 1.8 8v / Flex (112 cv Gasoline / 114 cv eta.) Bifuel/GNV 05>, Palio Weekend 1.8 8v Gasoline/GNV 03>, Palio Weekend 1.8 8v / HLX - Flex Bifuel/GNV 04>, Punto 1.8 8v MPI / Flex (113 cv Gasoline - 115 cv eta.) Bifuel/GNV 07>, Siena 1.8 8v Gasoline/GNV 03>, Siena 1.8 8v / Flex (112 cv Gasoline / 114 cv eta.) Bifuel/GNV 04>, Stilo 1.8 8v Gasoline/GNV 02>, Stilo 1.8 8v / Flex (112 cv Gasoline / 114 cv eta.) Gasoline/GNV 05>, Strada 1.8 8v Gasoline/GNV 03>, Strada 1.8 8v / Flex (112cv Gasoline / 114cv eta.) Bifuel/GNV 04>, Agile 1.4 8v / Econo.Flex (102 cv eta. / 97 cv Gasoline) Bifuel/GNV 09>, Blazer 2.4 8v / Flexpower (141 cv Gasoline - 147 cv eta.) Bifuel/GNV 07>, Celta 1.0 8v / SOHC mpfi (60 cv) Gasoline/GNV 00>, Celta 1.0 8v / VHC (70 cv) Gasoline/GNV, Celta 1.0 8v / VHC Flexpower (70 cv) Bifuel/GNV 05>, Celta 1.0 / VHCE (78 cv eta. / 77 cv Gasoline) Bifuel/GNV , Celta 1.4 8v / SOHC mpfi Gasoline/GNV 03>, Classic 1.0 8v / VHCE (77 cv Gasoline / 78 cv eta.) Bifuel/GNV 10>Cobalt 1.4 / Econo.Flex (99 cv gas / 105 cv eta.) Bifuel/GNV 11>, Cobalt 1.8 8v / Econo.Flex (106 cv Gasoline / 108 cv eta.) Bifuel/GNV 12>, Corsa 1.0 /1.4 /1.6 8v mpfi Gasoline/GNV 96>, Corsa 1.0 /1.4 /1.6 8v mpfi Ethanol/GNV 96>, Corsa 1.0 8v / VHC (70 cv) Gasoline/GNV 02>, Corsa 1.0 8v / Flexpower (77 cv Gasoline / 79 cv eta.) Bifuel/GNV 05>, Corsa 1.0 8v / Flexpower Classic (70cv Gasoline/ 72cv eta.) Bifuel/GNV 06>, Corsa 1.4 8v / Econo.Flex (99 cv gas / 105 cv eta.) Bifuel/GNV 07>, Corsa 1.8 8v - SOHC mpfi Gasoline/GNV 02>, Corsa 1.8 8v / Flexpower Bifuel/GNV 03>, Meriva 1.4 / Econo.Flex (99 cv Gasoline / 105 cv eta.) Bifuel/GNV 08>, Meriva 1.8 8v - SOHC mpfi Gasoline/GNV 02>, Meriva 1.8 8v / Flexpower Bifuel/GNV 03>, Montana 1.4 8v / Econo.flex (99 cv Gasoline - 105 cv eta.) Bifuel/GNV 07>, Montana 1.8 8v / Flexpower Bifuel/GNV 03>, Prisma 1.0 / VHCE (78 cv eta. / 77 cv gas) Bifuel/GNV 09>, Prisma 1.4 8v / Econo Flex (89 cv Gasoline / 97 cv eta.) Bifuel/GNV 06>, S-10 2.4 8v / Flexpower (141 cv Gasoline - 147 cv eta. - Coil in front of the engine) Bifuel/GNV 07>, Spin 1.8 8v / Econo.Flex (106 cv Gasoline / 108 cv eta.) Bifuel/GNV 12>

GC5020 // NEW //**FEATURES/ CARACTERISTICAS:**

PS: With resistive cable

REPLACES / REEMPLAZA:**Bosch:** F 000 99C 014; **NGK:** SC-G76**APPLICATION / APLICACIÓN:**

GM: Astra 1.8 / 2.0 8v - SOHC mpfi Gasoline/GNV 98>, Astra 1.8 / 2.0 8v - SOHC mpfi Ethanol/GNV 00>, Astra 2.0 8v / Flexpower (121cv gás. / 128cv eta.) Bifuel/GNV 204>, Astra 2.0 8v / Flexpower (133 cv Gasoline / 140 cv eta.) Bifuel/GNV , Vectra 2.0 8v / SOHC mpfi Gasoline/GNV 98>Vectra 2.0 8v / Flexpower (121 cv Gasoline / 128 cv eta.) Bifuel/GNV 05>, Vectra 2.0 8v / Flexpower (133cv Gasoline / 140cv eta.) Bifuel/GNV 09>, Vectra 2.2 8v / SOHC mpfi Gasoline/GNV 98>, Vectra GT / GTX 2.0 8v / Flexpower (121 cv Gasoline - 128 cv eta.) Bifuel/GNV 06>, Vectra GT / GTX 2.0 8v / Flexpower (133cv Gasoline / 140cv eta.) Bifuel/GNV , Zafira 2.0 8v Gasoline/GNV 01>, Zafira 2.0 8v / Flexpower (121 cv Gasoline - 128 cv eta.) Bifuel/GNV 04>, Zafira 2.0 8v / Flexpower (133 cv Gasoline / 140 cv eta.) Bifuel/GNV 09>

GC5021 // NEW //**FEATURES/ CARACTERISTICAS:**

PS: With resistive cable

REPLACES / REEMPLAZA:**Bosch:** F 000 99C 122; **NGK:** SC-T02**APPLICATION / APLICACIÓN:**

FIAT: Doblò 1.3 16v / Fire Gasoline/GNV, Palio 1.0 16v / Fire Gasoline/GNV 00>, Palio 1.3 16v / Fire Gasoline/GNV 00>, Palio Weekend 1.0 16v / Fire Gasoline/GNV 00>, Palio Weekend 1.3 16v / Fire Gasoline/GNV 00>Siena 1.0 16v / Fire Gasoline/GNV 00>, Siena 1.3 16v / Fire Gasoline/GNV 00>

GC5022 // NEW //**FEATURES/ CARACTERISTICAS:**

PS: With resistive cable

REPLACES / REEMPLAZA:**Bosch:** 9 295 080 026; **NGK:** SC-T04**APPLICATION / APLICACIÓN:**

FIAT: 147/Panorama/Rallye 1050 / 1300 Gasoline/GNV/Ethanol, Fiorino / Fiorino Pick-up 1.050 / 1.300 / carb. Gasoline/GNV/Ethanol >89, Oggi 1.050 / 1.300 / 1.415 Gasoline/GNV/Ethanol, Spazio 1.050 / 1.300 carb. Gasoline/GNV/Ethanol, Uno 1.050 / 1.300 / carb. Gasoline/GNV/Ethanol >89

GC5023 // NEW //**FEATURES/ CARACTERISTICAS:**

PS: With resistive cable

REPLACES / REEMPLAZA:**NGK:** SC-T07**APPLICATION / APLICACIÓN:**

FIAT: Uno 1.0 carb. / 1.0 i.e. / Mille Gasoline/GNV/Etanol 93>01

GC5024 // NEW //

FEATURES/ CARACTERISTICAS:

PS: With resistive cable

REPLACES / REEMPLAZA:
Bosch: F 000 99C 071; **NGK:** SC-T08

APPLICATION / APLICACIÓN:
FIAT: Brava 1.6 16v / mpi Gasoline/GNV 99>, Doblò 1.6 16v / mpi Gasoline/GNV 01>, Marea 1.6 16v / SX (106 cv) Gasoline/GNV 05>, Palio/Palio Weekend/ Siena/Strada 1.6 16v / mpi Gasoline/GNV All

GC5025 // NEW //

FEATURES/ CARACTERISTICAS:

PS: With resistive cable

REPLACES / REEMPLAZA:
Bosch: 9 295 080 030; **NGK:** SC-T41

APPLICATION / APLICACIÓN:
FIAT: Elba 1.6 8v / Carburado Gasoline/GNV 90>91, Elba 1.6 8v / Carburado Etanol/GNV 90>91, Prêmio 1.5 / carb. Gasoline/GNV >89, Prêmio 1.5 / carb. Etanol/GNV >89, Prêmio 1.6 / carb. Gasoline/GNV >91 Prêmio 1.6 / carb. Etanol/GNV >91, Uno 1.5 carb. Gasoline/GNV >89, Uno 1.5 carb. Etanol/GNV >89, Uno 1.5 R Gasoline/GNV >91, Uno 1.5 R Etanol/GNV >91

GC5026 // NEW //

FEATURES/ CARACTERISTICAS:

PS: With resistive cable

REPLACES / REEMPLAZA:
Bosch: 9 295 080 027; **NGK:** SC-T42

APPLICATION / APLICACIÓN:
FIAT: Elba 1.3/1.5 8v / Carburado Gasoline/GNV 86>89, Elba 1.3/1.5 8v / Carburado Etanol/GNV 86>89, Fiorino / Fiorino Pick-up / Uno Furgoneta 1.3 / 1.5 Gasoline/GNV 88>89, Fiorino / Fiorino Pick-up / Uno Furgoneta 1.3 / 1.5 Etanol/GNV 88>89, Uno 1.3 Gasoline/GNV 85>89, Uno 1.3 Etanol/GNV 85>89

GC5027 // NEW //

FEATURES/ CARACTERISTICAS:

PS: With resistive cable

REPLACES / REEMPLAZA:
Bosch: 9 295 080 036; **NGK:** SC-T53

APPLICATION / APLICACIÓN:
FIAT: Fiorino / Fiorino Pick-up 1.6 / mpi Gasoline/GNV 95>, Tipo 1.6 8v / mpi Gasoline/GNV, Uno 1.6 mpi Gasoline/GNV95>, Uno 1.6 mpi Etanol/GNV 95>

GC5028 // NEW //

FEATURES/ CARACTERISTICAS:

PS: With resistive cable

REPLACES / REEMPLAZA:
Bosch: F 000 99C 091; **NGK:** SC-T60

APPLICATION / APLICACIÓN:
FIAT: Palio/ Palio Weekend , Siena/ Strada 1.6 8v / mpi / spi Gasoline/GNV

GC5029 // NEW //

FEATURES/ CARACTERISTICAS:

PS: Resistive terminal

REPLACES / REEMPLAZA:
NGK: ST-F27

APPLICATION / APLICACIÓN:
FORD: Belina/ Corcel/ Del Rey/ Escort/ Pampa/ Verona 1.6 (CHT - AE) Gasoline/GNV/Ethanol >91

GC5030 // NEW //

FEATURES/ CARACTERISTICAS:

PS: Resistive terminal

REPLACES / REEMPLAZA:
Bosch: 9 295 080 040; **NGK:** ST-V01

APPLICATION / APLICACIÓN:
VW: Gol/Parati/Saveiro/Voyage 1.6 / 1.8 (AP) Gasoline/GNV 82>86, Gol/Parati/Saveiro/Voyage 1.6 / 1.8 (AP) Etanol/GNV 82>86, Passat 1.5 / 1.6 / 1.8 (AP) Gasoline/GNV 74>86, Passat 1.5 / 1.6 / 1.8 (AP) Etanol/GNV 74>86, Santana/Quantum 1.6 / 1.8 Gasoline/GNV 84>86, Santana/Quantum 1.6 / 1.8 Etanol/GNV 84>86

GC5031 // NEW //



FEATURES/ CARACTERISTICAS:

PS: Resistive terminal

REPLACES / REEMPLAZA:

Bosch: 9 295 080 041; **NGK:** ST-V02

APPLICATION / APLICACIÓN:

FORD: Escort 2.0 i (AP) / XR3 Gasoline/GNV 92, Escort 2.0 i (AP) / XR3 Ethanol/GNV 92, Royale/Versailles 1.8 / 2.0 (AP) Gasoline/GNV >94, Royale/Versailles 1.8 / 2.0 (AP) Ethanol/GNV >94, Gol/Royale/Versailles/Santana/Quantum 2.0 i (AP) Gasoline/GNV >93Gol/Royale/Versailles/Santana/Quantum 2.0 i (AP) Ethanol/GNV >93, Gol 2.0i (AP) / GTI Gasoline/GNV >93, Gol 2.0i CFI (AP) Gasoline/GNV >93, Gol 2.0i CFI (AP) Ethanol/GNV >93, Gol/Parati/Saveiro/Voyage/Passat/Santana/Quantum 1.6 / 1.8 / 2.0 (AP) Gasoline/GNV 87>, Gol/Parati/Saveiro/Voyage/Passat/Santana/Quantum 1.6 / 1.8 / 2.0 (AP) Ethanol/GNV 87>

GC5032 // NEW //



FEATURES/ CARACTERISTICAS:

PS: Resistive terminal

REPLACES / REEMPLAZA:

Bosch: 9 295 080 044; **NGK:** ST-V03

APPLICATION / APLICACIÓN:

VW: Gol 1.0 8v / carb. (AE) Gasoline/GNV, Gol/Parati/Saveiro/ 1.6 8v (AE) Gasoline/GNV/Ethanol 92>94

GC5033 // NEW //



FEATURES/ CARACTERISTICAS:

PS: Resistive terminal

REPLACES / REEMPLAZA:

Bosch: 9 295 080 020; **NGK:** ST-V04

APPLICATION / APLICACIÓN:

FORD: Escort 1.0/1.6 (AE) Gasoline/GNV/Ethanol 93>;

VW: Logus 1.6 8v (AE) Gasoline/GNV/Ethanol 93>94

GC5034 // NEW //



FEATURES/ CARACTERISTICAS:

PS: Resistive terminal

REPLACES / REEMPLAZA:

Bosch: 9 295 080 050; **NGK:** ST-V09

APPLICATION / APLICACIÓN:

VW: Gol/Parati 1.6i / 1.8i (AP) Gasoline/GNV 95>96, Gol/Parati 1.6i / 1.8i (AP) Ethanol/GNV 95>96, Parati 2.0i CFI / EFI (AP) Gasoline/GNV 95>97, Parati 2.0i CFI / EFI (AP) Ethanol/GNV 95>97

GC5035 // NEW //



FEATURES/ CARACTERISTICAS:

PS: Resistive terminal

REPLACES / REEMPLAZA:

Bosch: 9 295 080 051; **NGK:** ST-V11

APPLICATION / APLICACIÓN:

VW: Gol 1.0 8v / PLUS inj. (AE) Gasoline/GNV 95>96

GC5036 // NEW //



FEATURES/ CARACTERISTICAS:

PS: Resistive terminal

REPLACES / REEMPLAZA:

Bosch: F 000 99C 080, 9 295 080 042; **NGK:** ST-V12

APPLICATION / APLICACIÓN:

VW: Brasilia 1300 / 1600 Gasoline/GNV/Ethanol, Fusca 1.2 / 1.3 / 1.5 / 1.6 - short thread GNV/Ethanol 75>86, Fusca 1.2 / 1.3 / 1.5 / 1.6 - short thread Gasoline/GNV >83, Fusca 1.3 / 1.6 - long thread Gasoline/GNV/Ethanol 84>86, Fusca 1.6 (sem catalisador) - long thread Gasoline/GNV/Ethanol 93>96, Kombi 1.3 / 1.5 / 1.6 - short thread Gasoline/GNV/Ethanol, Kombi 1.6 (without catalisador) - long thread Gasoline/GNV/Ethanol

GC5037 // NEW //

FEATURES/ CARACTERISTICAS:

PS: Resistive terminal

REPLACES / REEMPLAZA:

Bosch: 9 295 080 047; **NGK:** ST-V13

APPLICATION / APLICACIÓN:

VW: Fusca 1.6 (with catalisator) - long thread Gasoline/GNV/Ethanol 93>96, Kombi 1.6 (with catalisator) - long thread Gasoline/GNV/Ethanol

GC5038 // NEW //

FEATURES/ CARACTERISTICAS:

PS: Resistive terminal

REPLACES / REEMPLAZA:

Bosch: F 000 99C 084; **NGK:** ST-V24

APPLICATION / APLICACIÓN:

VW: Gol/Parati 1.0 16v / Mi (AT) - with distributor Gasoline/GNV 97>01

GC5039 // NEW //

FEATURES/ CARACTERISTICAS:

PS: Resistive terminal

REPLACES / REEMPLAZA:

Bosch: F 000 99C 126; **NGK:** ST-V32

APPLICATION / APLICACIÓN:

VW: Gol/Parati/ 1.0 16v / without distributor (RSH) Gasoline/GNV 01>, Polo 1.0 16v (RSH) Gasoline/GNV 02>06

GC5040 // NEW //

FEATURES/ CARACTERISTICAS:

PS: Resistive terminal

REPLACES / REEMPLAZA:

Bosch: F 000 99C 599; **NGK:** ST-V38

APPLICATION / APLICACIÓN:

VW: Kombi 1.4 8v / Totalflex RSH (78 cv Gasoline / 80 cv eta. - EA 111) Bifuel/GNV 06>

GC5041 // NEW //

FEATURES/ CARACTERISTICAS:

PS: Resistive terminal

REPLACES / REEMPLAZA:

Bosch: F 000 99C 624; **NGK:** ST-V42

APPLICATION / APLICACIÓN:

VW: Fox 1.0 8v / Totalflex (72 cv Gasoline / 76 cv eta. - EA-111 RSH / VHT - CCN Tranf. 4X1) Bifuel/GNV 08>, Gol 1.0 8v / Totalflex G5 (72 cv Gasoline / 76 cv eta. - EA-111 RSH - VHT / CCN Tranf. 4X1) Bifuel/GNV 09>, Voyage 1.0 8v / Totalflex (72 cv Gasoline / 76 cv eta. - VHT / CCNA Tranf. 4X1) Bifuel/GNV 08>

GC5042 // NEW //

FEATURES/ CARACTERISTICAS:

PS: Resistive terminal

REPLACES / REEMPLAZA:

Bosch: F 000 99C 625; **NGK:** ST-V43

APPLICATION / APLICACIÓN:

VW: Bora 2.0 / Flex (120cv eta. / 116cv Gasoline - CFEA) Bifuel/GNV 09>; Golf 2.0 8v / Total Flex (116 cv Gasoline/120cv eta.-CFEA) Bifuel/GNV 08>, Jetta 2.0 (116 cv gas / 120 cv eta - CKJA) Bifuel/GNV 10>, Polo 2.0 8v / Totalflex (120cv eta / 116 cv Gasoline -CFEA) Bifuel/GNV 09>

GC5043 // NEW //

FEATURES/ CARACTERISTICAS:

PS: Resistive terminal

REPLACES / REEMPLAZA:

Bosch: 9 295 080 049; **NGK:** ST-V08

APPLICATION / APLICACIÓN:

FORD: Escort 1.6 / 1.8 (AP) inj. 95>, Escort 2.0 EFI (AP) Gasoline/GNV/Ethanol 95>, Verona 1.6 (AP) - inj. Gasoline/GNV 95>, Verona 1.6 / 1.8 (AP) - inj. Ethanol/GNV 95>, Verona 1.8 (AP) - inj. Gasoline/GNV 95>Verona 2.0 (AP) efi Gasoline/GNV/Ethanol 95>;

VW: Logus 1.6 CFI (AP) Gasoline/GNV 95>96, Logus 1.6 CFI / 1.8 CFI / 2.0 EFI (AP) Ethanol/GNV 95>96, Logus 1.8 CFI (AP) Gasoline/GNV 95>96, Logus 2.0 EFI (AP) Gasoline/GNV 95>96, Pointer 1.8/2.0 - cfi / efi (AP) Ethanol/GNV 95>96, Pointer 1.8 CFI (AP) Gasoline/GNV 95>96, Pointer 2.0 EFI (AP) Gasoline/GNV 95>96



GC5044 // NEW //

FEATURES/ CARACTERISTICAS:

PS: Resistive terminal

REPLACES / REEMPLAZA:

NGK: ST-V19

APPLICATION / APLICACIÓN:

VW: Santana / Quantum 1.8 Mi (AP) Gasoline/GNV/Ethanol 97>, Santana / Quantum 2.0 Mi (AP) Gasoline/GNV/Ethanol 97>



GC5045 // NEW //

FEATURES/ CARACTERISTICAS:

PS: With resistive cable

REPLACES / REEMPLAZA:

Bosch: F 000 99C 072; **NGK:** SC-F03

APPLICATION / APLICACIÓN:

FORD: Escort 1.8 16v / Zetec Gasoline/GNV, Mondeo 1.8 / 2.0 16v / (Zetec) GLX / CLX Gasoline/GNV 94>98



GC5046 // NEW //

FEATURES/ CARACTERISTICAS:

PS: With resistive cable

REPLACES / REEMPLAZA:

Bosch: F 000 99C 128; **NGK:** SC-G72

APPLICATION / APLICACIÓN:

GM: Ipanema 2.0 - mpi Gasoline/GNV/Ethanol 97>98, Kadett 2.0 - mpi Gasoline/GNV/Ethanol 97>98, Vectra 2.0 8v / CD / GLS mpi Gasoline/GNV



GC5047 // NEW //

FEATURES/ CARACTERISTICAS:

PS: Resistive terminal

REPLACES / REEMPLAZA:

Bosch: F 000 99C 124; **NGK:** ST-V23

APPLICATION / APLICACIÓN:

VW: Kombi 1.6 (air, electronic injection) - long thread Gasoline/GNV/Ethanol 98>; Kombi 1.6 Mi / se fi ref. Air long thread Gasoline/GNV/Ethanol 98>



GC5048 // NEW //

FEATURES/ CARACTERISTICAS:

PS: Resistive terminal

REPLACES / REEMPLAZA:

Bosch: 9 295 080 018; **NGK:** ST-F22

APPLICATION / APLICACIÓN:

FORD: Belina / Corcel / Del Rey 1.8 (AP) Gasoline/GNV/Ethanol >91, Del Rey 1.8 (AP) Gasoline/GNV/Ethanol 92, Escort 1.8 (AP) Gasoline/GNV/Ethanol >91, Pampa 1.8 (AP) Gasoline/GNV/Ethanol >91, Verona 1.8 (AP) Gasoline/GNV/Ethanol >91;

VW: Apollo 1.8 - carb. (AP) / Coil without pin Gasoline/GNV/Ethanol 90>92



GC5049 // NEW //

FEATURES/ CARACTERISTICAS:

PS: With resistive cable

REPLACES / REEMPLAZA:

Bosch: F 000 99C 075; **NGK:** SC-G79

APPLICATION / APLICACIÓN:

DAEWOO: Lanos 1.6 16v - DOHC Gasoline/GNV 99;

GM: Calibra 2.0 16v (X20XE) Gasoline/GNV 94>95, Corsa 1.0 / 1.6 16v Gasoline/GNV, Tigra 1.6 16v Gasoline/GNV 98>99



GC5050 // NEW //

FEATURES/ CARACTERISTICAS:

PS: With resistive cable

REPLACES / REEMPLAZA:

Bosch: F 000 99C 013; **NGK:** SC-G80

APPLICATION / APLICACIÓN:

GM: Astra 1.8 / 2.0 8v - SOHC hexagon 16 mm (C20NE) Gasoline/GNV 95

GC5051 // NEW //
FEATURES/ CARACTERISTICAS:

PS: Resistive terminal

REPLACES / REEMPLAZA:
Bosch: F 000 99C 062; **NGK:** ST-V16

APPLICATION / APLICACIÓN:
FORD: Royale / Versailles 1.8 / 2.0 (AP) cfi / efi / e-core with pin on the transformer Gasoline/GNV/Ethanol 95>96;

VW: Gol 1.6i / 1.8i (AP) (e-core) with pin on the transformer Gasoline/GNV/Ethanol 95>96, Santana / Quantum 1.8 / 2.0 - cfi / efi (AP) e-core cwith pin on the transformer Gasoline/GNV/Ethanol 95>96

GC5052 // NEW //
FEATURES/ CARACTERISTICAS:

PS: Resistive terminal

REPLACES / REEMPLAZA:
Bosch: F 000 99C 078; **NGK:** ST-V28

APPLICATION / APLICACIÓN:
SEAT: Cordoba 1.6 8v (100 hp - AKL) Gasoline/GNV 99>00, Ibiza 1.6 8v (100 hp - AKL) Gasoline/GNV 99>03, Vario 1.6 8v (100 hp - AKL) Gasoline/GNV 99>03;

VW: Bora 2.0 8v (116 cv - CBPA) Gasoline/GNV 07>, Bora 2.0 8v (APK / BHP / BER) Gasoline/GNV 00>07Bora 2.0 8v (116 cv - CBPA) Gasoline/GNV 07>, Golf 1.6 8v - Alemão / A4 (EA111) Gasoline/GNV 98>99, Golf 1.6 8v (AKL) - tucho hidráulico / A4 (EA 113 - aluminum sump) Gasoline/GNV 99>01, Golf 2.0 8v (APK / AEG / AKL / BER / BHP / CBPA) Gasoline/GNV 99>, New Beetle 2.0 8v (116 cv) Gasoline/GNV 99>05, New Beetle 2.0 8v (116 cv - BER / BHP / CBPA) Gasoline/GNV 05>, Polo 2.0 8v (116 cv - BBX) Gasoline/GNV 02>06, Polo Sedan 2.0 8v (116 cv - BBX) Gasoline/GNV 02>

GC5053 // NEW //
FEATURES/ CARACTERISTICAS:

PS: With resistive cable

REPLACES / REEMPLAZA:
Bosch: F 000 99C 092; **NGK:** SC-G81

APPLICATION / APLICACIÓN:
GM: Blazer 4.3 V6 Gasoline/GNV 96>, S10 4.3 V6 Gasoline/GNV 96>

GC5054 // NEW //
FEATURES/ CARACTERISTICAS:

PS: Resistive terminal

REPLACES / REEMPLAZA:
Bosch: 9 295 080 021; **NGK:** ST-V05

APPLICATION / APLICACIÓN:
FORD: Escort 1.6 / 1.8 (AP) Gasoline/GNV/Ethanol 93>94, Pampa 1.8i / coil with internal lock (AP) Gasoline/GNV 97, Verona 1.6 / 1.8 (AP) Gasoline/GNV/ Ethanol 93>94;

VW: Logus 1.6 / 1.8 / 2.0 (AP) Gasoline/GNV/Ethanol 93>94

GC5055 // NEW //
FEATURES/ CARACTERISTICAS:

PS: With resistive cable

REPLACES / REEMPLAZA:
Bosch: F 000 99C 067; **NGK:** SC-T58

APPLICATION / APLICACIÓN:
FIAT: Tipo 1.6 8v / ie Gasoline/GNV

GC5056 // NEW //
FEATURES/ CARACTERISTICAS:

PS: Resistive terminal

REPLACES / REEMPLAZA:
Bosch: 9 295 080 046; **NGK:** ST-F28

APPLICATION / APLICACIÓN:
VW: Gol 1.6 8v (AE) Gasoline/GNV/Ethanol >91, Parati 1.6 8v (AE) Gasoline/GNV/Ethanol >91, Saveiro 1.6 8v (AE) Gasoline/GNV/Ethanol >91



GC5057 // NEW //

FEATURES/ CARACTERÍSTICAS:

PS: With resistive cable

REPLACES / REEMPLAZA:

Bosch: F 000 99C 119; **NGK:** SC-G74

APPLICATION / APLICACIÓN:

GM: Blazer 2.2 - EFI - transf. behind the engine Gasoline/GNV >96; S-10 2.2 - EFI - transf. behind the engine Gasoline/GNV >96



GC5058 // NEW //

REPLACES / REEMPLAZA:

Bosch: F 000 99C 131; **NGK:** SC-G90

APPLICATION / APLICACIÓN:

GM: Blazer 2.4 mpfi Gasoline/GNV 01>; S-10 2.4 mpfi (coil behind the engine) Gasoline/GNV 01>06



GC5059 // NEW //

FEATURES/ CARACTERÍSTICAS:

PS: Resistive terminal

REPLACES / REEMPLAZA:

Bosch: 9 295 080 059; **NGK:** ST-V07

APPLICATION / APLICACIÓN:

FORD: Pampa 1.6 / 1.8 (AP) Gasoline/GNV/Ethanol 93>96



GC5060 // NEW //

FEATURES/ CARACTERÍSTICAS:

PS: With resistive cable

REPLACES / REEMPLAZA:

Bosch: F 000 99C 079; **NGK:** SC-R11

APPLICATION / APLICACIÓN:

RENAULT: Clio 1.0 8v / spark plug with hexagon 16mm and long term. cable. (D7D) Gasoline/GNV, Kangoo 1.0 8v / spark plug with hexagon 16mm and long term. cable. (D7D) Gasoline/GNV, Twingo 1.0 8v / spark plug with hexagon 16mm and long term. cable (D7D) Gasoline/GNV , Twingo 1.2 8v / spark plug with hexagon 16mm and long term. cable. (D7F) Gasoline/GNV 99>



GC5061 // NEW //

FEATURES/ CARACTERÍSTICAS:

PS: With resistive cable

REPLACES / REEMPLAZA:

Bosch: 9 295 080 028; **NGK:** SC-T47

APPLICATION / APLICACIÓN:

FIAT: Elba 1.5 8v / Carburado (E201) Gasoline/GNV 91, Fiorino / Fiorino Pick-up 1.3 / 1.5 Gasoline/GNV/Ethanol 90>91, Prêmio 1.3 / 1.5 Gasoline/GNV/Ethanol 90>91, Uno 1.0 carb. / Mille Gasoline/GNV 90>91, Uno 1.3 / 1.5 carb. Gasoline/GNV/Ethanol 90>91, Uno Furgoneta 1.3 / 1.5 Gasoline/GNV/Ethanol 90>91



GC5062 // NEW //

FEATURES/ CARACTERÍSTICAS:

PS: With resistive cable

REPLACES / REEMPLAZA:

Bosch: F 000 99C 121; **NGK:** SC-F10

APPLICATION / APLICACIÓN:

FORD: Focus 1.8 / 2.0 16v / Zetec (115 / 130 cv) Gasoline/GNV 00>, Mondeo 1.8 / 2.0 16v / (Zetec) GLX / CLX Gasoline/GNV 98>01



GC5063 // NEW //

FEATURES/ CARACTERÍSTICAS:

PS: With resistive cable

REPLACES / REEMPLAZA:

Bosch: F 000 99C 025; **NGK:** SC-G77

APPLICATION / APLICACIÓN:

GM: Blazer 2.2 L4 - mpfi Gasoline/GNV 97>, S-10 2.2 L4 - mpfi Gasoline/GNV 97>

GC5064 // NEW //
FEATURES/ CARACTERÍSTICAS:

PS: With resistive cable

REPLACES / REEMPLAZA:

Bosch: F 000 99C 602; **NGK:** SC-R16

APPLICATION / APLICACIÓN:

NISSAN: March 1.0 16v (74 cv - D4D) Bifuel/GNV 11>;

RENAULT: Clio 1.0 16v / Hi-Flex (76 cv Gasoline/ 77 cv eta. - D4D) Bifuel/GNV 05>, Kangoo 1.0 16v / Hi-Flex (76 cv Gasoline/ 77 cv eta. - D4D) Bifuel/GNV 05>, Logan 1.0 16v / Hi-Flex (76 cv Gasoline / 77 cv eta. - D4D) Bifuel/GNV 07>, Sandero 1.0 16v / Hi-Flex (76 cv Gasoline / 77 cv eta. - D4D) Bifuel/GNV 08>

GC5065 // NEW //
FEATURES/ CARACTERÍSTICAS:

PS: With resistive cable

REPLACES / REEMPLAZA:

Bosch: 9 295 080 009; **NGK:** SC-G69

APPLICATION / APLICACIÓN:

GM: Vectra 2.0 8v / CD / GLS mpfi Gasoline/GNV 93>95

GC5066 // NEW //
FEATURES/ CARACTERÍSTICAS:

PS: With resistive cable

REPLACES / REEMPLAZA:

Bosch: 9 295 080 029; **NGK:** SC-T44

APPLICATION / APLICACIÓN:

FIAT: Elba 1.5 8v / Carb. (E201) Gasoline/GNV/Ethanol 92>93, Fiorino / Fiorino Pick-up 1.5 / carb. Gasoline/GNV/Ethanol 92>, Prémio 1.5 / carb. Gasoline/GNV/Ethanol 92>, Uno 1.0 carb. / Mille Gasoline/GNV 92>93, Uno 1.5 carb. Gasoline/GNV/Ethanol 92>, Uno Furgoneta 1.5 carb. Gasoline/GNV/Ethanol 92>

GC5067 // NEW //
FEATURES/ CARACTERÍSTICAS:

PS: Resistive terminal

REPLACES / REEMPLAZA:

Bosch: F 000 99C 068; **NGK:** ST-V20

APPLICATION / APLICACIÓN:

SEAT: Inca 1.6 8v Mi (AP) Gasoline/GNV 98>03;

VW: Passat / Variant 2.0 - hexagon 21mm (527) Gasoline/GNV 94>97, Polo classic 1.6 8v / Mi (88,5 cv - MJ3) Gasoline/GNV 96>98, Polo classic 1.6 8v / Mi (90 cv - MY4) Gasoline/GNV 98>03, Polo classic 1.8 8v / Mi (99 cv - MJ2) Gasoline/GNV 96>98, Polo classic 1.8 8v / Mi (105 cv / 96,6 cv - MY5 / MY6) Gasoline/ GNV 98>03, Van 1.6 8v / Mi Gasoline/GNV 98>03

GC5068 // NEW //
FEATURES/ CARACTERÍSTICAS:

PS: Resistive terminal

REPLACES / REEMPLAZA:

NGK: ST-F26

APPLICATION / APLICACIÓN:

FORD: Escort 1.6 (AE) Gasoline/GNV/Ethanol 92; Pampa 1.6 (AE) Gasoline/GNV/Ethanol 92, Verona 1.6 (CHT - AE) Gasoline/GNV/Ethanol 92

GC5069 // NEW //
FEATURES/ CARACTERÍSTICAS:

PS: With resistive cable

REPLACES / REEMPLAZA:

Bosch: F 000 99C 612; **NGK:** SC-G101

APPLICATION / APLICACIÓN:

GM: Onix 1.0 8v / SPE (78cv Gasoline / 80cv eta.) Bifuel/GNV 12>, Onix 1.4 8v / SPE (98 cv gas / 106 cv eta. - LKL) Bifuel/GNV 12>, Prisma 1.0 8v / SPE (78cv Gasoline / 80cv eta.) Bifuel/GNV 13>, Prisma 1.4 8v / SPE (98 cv Gasoline / 106 cv eta.) Bifuel/GNV 13>

GC5070 // NEW //



FEATURES/ CARACTERÍSTICAS:

PS: With resistive cable

REPLACES / REEMPLAZA:

Bosch: F 000 99C 135; **NGK:** SC-R13

APPLICATION / APLICACIÓN:

RENAULT: Clio 1.6 8v - hexagon 16mm (K7M) Gasoline/GNV 98>, Kangoo 1.6 8v (K7M) Gasoline/GNV 98>, Logan 1.6 8v - Hi-Torque / Flex (92 cv Gasoline / 95 cv eta. - K7M Bifuel/GNV 07>, Megane 1.6 8v (K7M) Gasoline/GNV 99>, Sandero 1.6 8V - Hi Torque / Flex (92 cv Gasoline / 95 cv eta. - K7M) Bifuel/GNV 08>, Symbol 1.6 8v / Hi - Torque (95 cv eta. / 92 cv Gasoline - K7M) Bifuel/GNV 09>

GC5071 // NEW //



FEATURES/ CARACTERÍSTICAS:

PS: With resistive cable

REPLACES / REEMPLAZA:

Bosch: F 000 99C 140; **NGK:** SC-R08

APPLICATION / APLICACIÓN:

RENAULT: Megane 2.0 8v (F3R) Gasoline/GNV 97>, Scenic 2.0 8v (F3R) Gasoline/GNV 97>, Trafic 2.0 8v / Injection (F3R) Gasoline/GNV

GC5072 // NEW //



FEATURES/ CARACTERÍSTICAS:

PS: With resistive cable

REPLACES / REEMPLAZA:

Bosch: 9 295 080 006; **NGK:** SC-G67

APPLICATION / APLICACIÓN:

GM: Omega / Suprema 2.0 4Cil. - mpfi Gasoline/GNV/Ethanol 93>94

GC5073 // NEW //



FEATURES/ CARACTERÍSTICAS:

PS: With resistive cable

REPLACES / REEMPLAZA:

Bosch: F 000 99C 132; **NGK:** SC-F23

APPLICATION / APLICACIÓN:

FORD: EcoSport 2.0 16v / Duratec (manual gear) (143 cv) Gasoline/GNV 03>08, Focus 2.0 16v / Duratec (manual gear) (147cv-HEIB) Gasoline/GNV 05>, Mondeo 2.0 16v Duratec Gasoline/GNV 01>

GC5074 // NEW //



FEATURES/ CARACTERÍSTICAS:

PS: With resistive cable

REPLACES / REEMPLAZA:

Bosch: F 000 99C 106; **NGK:** SC-K01

APPLICATION / APLICACIÓN:

HONDA: Civic 1.6 16v / EX Gasoline/GNV 96>00, Civic 1.6 16v / LX / LXB Gasoline/GNV 96>00, Civic 1.6 16v / EX Gasoline/GNV 96>00

GC5075 // NEW //



FEATURES/ CARACTERÍSTICAS:

PS: With resistive cable

REPLACES / REEMPLAZA:

NGK: SC-F11; **Bosch:** F 000 99C 074

APPLICATION / APLICACIÓN:

FORD: Courier 1.4 16v / Zetec Gasoline / GNV 1997>1999, Fiesta 1.4 16v / Zetec Gasoline / GNV

GC5076 // NEW //



FEATURES/ CARACTERÍSTICAS:

PS: With resistive cable

REPLACES / REEMPLAZA:

NGK: SC-A02; **Bosch:** F 000 99C 104

APPLICATION / APLICACIÓN:

ASIA MOTORS: Towner Van (carb.) Gasoline / GNV

GC5077 // NEW //

FEATURES/ CARACTERÍSTICAS:

PS: With resistive cable

REPLACES / REEMPLAZA:
NGK: SC-W04

APPLICATION / APLICACIÓN:
TOYOTA: Corolla 1.6 16v (4A-FE) Gasoline/GNV 92>98, Corolla 1.8 16v (7A-FE) Gasoline/GNV 92>02

GC5078 // NEW //

FEATURES/ CARACTERÍSTICAS:

PS: With resistive cable

REPLACES / REEMPLAZA:
NGK: SC-T65; **Bosch:** F 000 99C 146

APPLICATION / APLICACIÓN:
FIAT: Palio 1.0 8v / Fire EVO (73 gas. / 75 eta.) Bicombustível / GNV 2012>, Uno 1.0 / Fire EVO (73 cv gas. / 75 cv eta.) Bicombustível / GNV 2010>

GC5079 // NEW //

FEATURES/ CARACTERÍSTICAS:

PS: Resistive terminal

REPLACES / REEMPLAZA:
Bosch: 9 295 080 043; **NGK:** ST-V22

APPLICATION / APLICACIÓN:
VW: Gol 1.3 / 1.6 (air cooling) - long thread Gasoline/GNV/Ethanol, Gol 1.6 (air cooling) - short thread Gasoline/GNV/Ethanol, Saveiro 1.3 / 1.6 - air cooling - long thread Gasoline/GNV/Ethanol, Saveiro 1.6 air cooling - short thread Gasoline/GNV/Ethanol

GC5080 // NEW //

FEATURES/ CARACTERÍSTICAS:

PS: With resistive cable

REPLACES / REEMPLAZA:
Bosch: F 000 99C 147; **NGK:** SC-T64

APPLICATION / APLICACIÓN:
FIAT: 500 1.4 8v / Fire EVO (85 cv Gasoline / 88 cv eta.) Bifuel/GNV 11>, Fiorino 1.4 8v / Fire EVO (85 cv Gasoline / 88 cv eta.) Bifuel/GNV 10>, Grand Siena 1.4 8v / Fire EVO (85 cv Gasoline / 88 cv eta.) Bifuel/GNV 12>, Grand Siena Tetrafuel 1.4 8v / Fire EVO (75 cv gnv / 85 cv Gasoline / 88 cv eta) Tetrafuel/GNV 11, Palio 1.4 8v / Fire EVO (85cv Gasoline / 88cv eta.) Bifuel/GNV 11>, Punto 1.4 8v / Fire Evo (85 cv Gasoline / 88 cv eta.) Bifuel/GNV 12>, Uno 1.4 / Fire EVO (85cv Gasoline / 88cv eta.) Bifuel/GNV 10>

GC5081 // NEW //

FEATURES/ CARACTERÍSTICAS:

PS: With resistive cable

REPLACES / REEMPLAZA:
Bosch: F 000 99C 613; **NGK:** SC-F24

APPLICATION / APLICACIÓN:
FORD: Ranger 2.3 8v Gasoline/GNV 96>97, Ranger 2.5 8v Gasoline/GNV 97>01

GC5082 // NEW //

FEATURES/ CARACTERÍSTICAS:

PS: With resistive cable

REPLACES / REEMPLAZA:
Bosch: 9 295 080 031; **NGK:** SC-T45

APPLICATION / APLICACIÓN:
FIAT: Elba 1.6 8v / Carb. Gasoline/GNV 92>93, Elba 1.6 8v / Carb. Ethanol/GNV 92>94, Fiorino Fiorino Pick-up 1.6 / carb. Gasoline/GNV/Ethanol 92>, Prêmio 1.6 / carb. Gasoline/GNV/Ethanol 92>, Uno 1.6 Gasoline/GNV/Ethanol 92>, Uno 1.6 R / Carb. Gasoline/GNV/Ethanol 90>93

GC5083 // NEW //



FEATURES/ CARACTERÍSTICAS:

PS: With resistive cable

REPLACES / REEMPLAZA:

Bosch: F 000 99C 143; **NGK:** SC-T66

APPLICATION / APLICACIÓN:

FIAT: Bravo 1.8 16v / E.torQ (130 cv Gasoline / 132 cv eta.) Bifuel/GNV 11>, Dobló 1.8 16v / E.torQ (130 cv Gasoline / 132 cv eta.) Bifuel/GNV 11>, Dobló Adventure 1.8 16v / E.torQ (130 cv Gasoline / 132 cv eta.) Bifuel/GNV 11>, Idea 1.6 16v / E.torQ (115 cv Gasoline / 117 cv eta.) Bifuel/GNV 11>, Idea 1.8 16v / E.torQ (130 cv Gasoline / 132 cv eta.) Bifuel/GNV 11>Linea 1.8 16v / E.torQ (130 cv Gasoline / 132 cv eta.) Bifuel/GNV 11>, Palio 1.6 16v / E.torQ (115 cv Gasoline / 117 cv eta.) Bifuel/GNV 12>, Palio Adventure 1.8 16v / E.torQ (130 cv Gasoline / 132 cv eta.) Bifuel/GNV 11>, Punto 1.6 16v / E.torQ (115 cv Gasoline / 117cv eta.) Bifuel/GNV 11>, Punto 1.8 16v / E.torQ (130 cv Gasoline / 132 cv eta.) Bifuel/GNV 11>, Siena 1.6 16v / E.torQ (115 cv Gasoline / 117 cv eta.) Bifuel/GNV 11>, Strada 1.8 16v / E.torQ (130 cv Gasoline / 132 cv eta.) Bifuel/GNV 11>

GC5084 // NEW //



FEATURES/ CARACTERÍSTICAS:

PS: With resistive cable

REPLACES / REEMPLAZA:

Bosch: 9 295 080 007; **NGK:** SC-G71

APPLICATION / APLICACIÓN:

GM: Omega / Suprema 2.2 4Cil. - mpfi Gasoline/GNV/Ethanol 95>

GC5085 // NEW //



FEATURES/ CARACTERÍSTICAS:

PS: With resistive cable

REPLACES / REEMPLAZA:

NGK: SC-S01

APPLICATION / APLICACIÓN:

SUZUKI: Samurai 1.3 (SJ413-6 / G13A) Gasoline/GNV 93>; Samurai 1.3 / Canvas / Metal Top Gasoline/GNV 93>

GC5086 // NEW //



FEATURES/ CARACTERÍSTICAS:

PS: Resistive terminal

REPLACES / REEMPLAZA:

Bosch: 9 295 080 048; **NGK:** ST-V10

APPLICATION / APLICACIÓN:

FORD: Royale / Versailles 1.8 / 2.0 (AP) cfi / efi / e-core with pin on the transformer Gasoline/GNV/Ethanol 95>;
VW: Santana / Quantum 1.8 / 2.0 - cfi / efi (AP) i-core without pin on the transformer Gasoline/GNV/Ethanol 95>96

GC5087 // NEW //



FEATURES/ CARACTERÍSTICAS:

PS: With resistive cable

REPLACES / REEMPLAZA:

Bosch: F 000 99C 073; **NGK:** SC-F12

APPLICATION / APLICACIÓN:

FORD: Ranger 4.0 V6 / OHV Gasoline/GNV 94>03, Ranger 4.0 V6 - OHV Gasoline/GNV 97>01

GC5088 // NEW //



FEATURES/ CARACTERÍSTICAS:

PS: With resistive cable

REPLACES / REEMPLAZA:

Bosch: F 000 99C 134; **NGK:** SC-N08

APPLICATION / APLICACIÓN:

HYUNDAI: i30 2.0 (145 cv - G4GC) Gasoline/GNV 08>, Tucson 2.0 Gasoline/GNV 04>;

KIA: Sportage 2.0 16v CVVT (142 cv) Gasoline/GNV 04>

GC5089 // NEW //



FEATURES/ CARACTERÍSTICAS:

PS: With resistive cable

REPLACES / REEMPLAZA:

Bosch: 9 295 080 055; **NGK:** SC-T55

APPLICATION / APLICACIÓN:

FIAT: Tempra 2.0 16v / with distributor Gasoline/GNV 93>94

GC5090 // NEW //
FEATURES/ CARACTERÍSTICAS:

PS: With resistive cable

REPLACES / REEMPLAZA:
Bosch: F 000 99C 144; **NGK:** SC-F35

APPLICATION / APLICACIÓN:
FORD: Ecosport 1.6 16v / Sigma (109cv Gasoline / 116cv eta.) Bifuel/GNV 12>, Fiesta 1.5 16v N-VCT / Sigma (107 cv Gasoline/ 111 cv eta.) Bifuel/GNV 13>, Fiesta 1.6 16v / Sigma (110 cv Gasoline / 115 cv eta.) Bifuel/GNV 10>, Fiesta 1.6 16v Ti-VCT / Sigma (125 cv Gasoline/130 cv eta.) Bifuel/GNV 13>, Focus 1.6 16v / Sigma (109cv Gasoline / 116cv eta.) Bifuel/GNV 10>, Focus 1.6 16v Ti-VCT / Sigma (131 cv Gasoline/135 cv eta.) Bifuel/GNV 13>, Ka 1.5 16v / TiVCT (105 cv Gasoline / 110 cv eta.) Bifuel/GNV 14>

GC5091 // NEW //
FEATURES/ CARACTERÍSTICAS:

PS: With resistive cable

REPLACES / REEMPLAZA:
Bosch: F 000 99C 145; **NGK:** SC-T63

APPLICATION / APLICACIÓN:
FIAT: Linea 1.9 16v / Flex (130 cv Gasoline / 132 cv eta.) Bifuel/GNV 08>

GC5092 // NEW //
FEATURES/ CARACTERÍSTICAS:

PS: With resistive cable

REPLACES / REEMPLAZA:
Bosch: F 000 99C 070; **NGK:** SC-T57

APPLICATION / APLICACIÓN:
FIAT: Tempra 2.0 16v / without distributor Gasoline/GNV 96>

GC5093 // NEW //
FEATURES/ CARACTERÍSTICAS:

PS: With resistive cable

REPLACES / REEMPLAZA:
Bosch: F 000 99C 086; **NGK:** SC-R06

APPLICATION / APLICACIÓN:
RENAULT: Clio 1.6 8v - hexagon 21mm (C3L) Gasoline/GNV >99, R-19 1.6 8v - hexagon 21 mm (C3L) Gasoline/GNV >99

GC5094 // NEW //
FEATURES/ CARACTERÍSTICAS:

PS: With resistive cable

REPLACES / REEMPLAZA:
Bosch: F 000 99C 024; **NGK:** SC-G75

APPLICATION / APLICACIÓN:
GM: C-20 4.1 6Cil. - 250 Gasoline/GNV 1996, Gran Blazer 4.1 cil Gasoline/GNV 97>99, Omega / Suprema 4.1 L6 - mpfi Gasoline/GNV, Silverado 4.1 L6 Gasoline/GNV 97>99

GC5095 // NEW //
FEATURES/ CARACTERÍSTICAS:

PS: With resistive cable

REPLACES / REEMPLAZA:
NGK: SC-T56

APPLICATION / APLICACIÓN:
FIAT: Tempra 2.0 16v / without distributor Gasoline/GNV 95

GC5096 // NEW //
FEATURES/ CARACTERÍSTICAS:

PS: With resistive cable

REPLACES / REEMPLAZA:
Bosch: F 000 99C 088; **NGK:** SC-P01

APPLICATION / APLICACIÓN:
PEUGEOT: 106 1.0i 8v (TU9M) Gasoline/GNV 96>, 205 1.4 8v Gasoline/GNV, 306 1.6i 8v / XS (TU5JP) Gasoline/GNV

GC5097 // NEW //



FEATURES/ CARACTERÍSTICAS:

PS: With resistive cable

REPLACES / REEMPLAZA:

Bosch: F 000 99C 087, F 000 99C 095, F 000 99C 096; **NGK:** SC-H01

APPLICATION / APLICACIÓN:

CITROËN: Berlingo 1.8 8v (XU7JB / LFX) Gasoline/GNV 98>, Xsara 1.8 8v - inj. (XU7JP) Gasoline/GNV 93>, ZX 1.8 8v (XU7JP) 93>;

PEUGEOT: 306 1.8i / XN / XR / SR / SL / Cabrio (XU7JP) Gasoline/GNV 96>99, 405 1.6 8v / GL/GR (XU5JP) Gasoline/GNV 95>, 405 1.8 / SR/GR (XU7JP) Gasoline/GNV 95>, Partner 1.8 8v (XU7JB) Gasoline/GNV 99>03

GC5098 // NEW //



FEATURES/ CARACTERÍSTICAS:

PS: With resistive cable

REPLACES / REEMPLAZA:

NGK: SC-S02

APPLICATION / APLICACIÓN:

SUZUKI: Vitara 1.6 8v / 3 DR with distributor (G16P) Gasoline/GNV 93>

GC5099 // NEW //



FEATURES/ CARACTERÍSTICAS:

PS: Resistive terminal

REPLACES / REEMPLAZA:

Bosch: 9 295 080 017; **NGK:** ST-F25

APPLICATION / APLICACIÓN:

FORD: Escort 1.8 (AP) Gasoline/GNV/Ethanol 92, Pampa 1.8 (AP) Gasoline/GNV/Ethanol 92;

VW: Verona 1.8 (AP) Gasoline/GNV/Ethanol 92, Apollo 1.8 - carb. (AP) / Coil with pin Ethanol/GNVeGasoline/GNV 02/92>11/92

GC5100 // NEW //



FEATURES/ CARACTERÍSTICAS:

PS: Resistive terminal

REPLACES / REEMPLAZA:

NGK: SC-G94

APPLICATION / APLICACIÓN:

GM: Luv 2.2 D-MAX 2.4 Petrol (Gasoline) 2000>2004

GC5101 // NEW //



FEATURES/ CARACTERÍSTICAS:

...

REPLACES / REEMPLAZA:

NGK: SC-G83

APPLICATION / APLICACIÓN:

CHEVROLET: Luv 2.3 1991>2002, Luv 1.6/2.3 1989>, Luv 1.8/2.0 1981>1998

GC5102 // NEW //



FEATURES/ CARACTERÍSTICAS:

...

REPLACES / REEMPLAZA:

NGK: SC-G02

APPLICATION / APLICACIÓN:

CHEVROLET: Spark 0.8/1.0 2005>2010

GC5103 // NEW //



FEATURES/ CARACTERÍSTICAS:

...

REPLACES / REEMPLAZA:

NGK: SC-E06

APPLICATION / APLICACIÓN:

NISSAN: Sentra II 1.6 1990>1995, Sentra 1.6 1996>2007, V16 1997>, X trail 2.5 2001>

GC5104 // NEW //

FEATURES/ CARACTERÍSTICAS:

...

REPLACES / REEMPLAZA:

Suzuki: 2714(33705-71C20), 27143370571C20, 33705-51G20, 3370551G20, 33705-57B21, 3370557B21, 33705-60G20, 3370560G20, 3370566D00, 33705-71C10, 3370571C10; **Valeo:** 346533

APPLICATION / APLICACIÓN:

SUZUKI: Baleno (Eg) 1.3 1996>2002, Baleno (Eg) 1.3 I 16V 1995>2002, Baleno (Eg) 1.6 I 16V 1995>2002, Baleno (Eg) 1.6 I 16V 4X4 1995>2002, Baleno Hatch (Eg) 1.3 1996>2002, Baleno Hatch (Eg) 1.3 I 16V 1995>2002, Baleno Hatch (Eg) 1.6 I 16V 1995>2002, Baleno Hatch (Eg) 1.6 I 16V 4X4 1995>2002, Baleno Sw (Eg) 1.3 16V 1997>2002, Baleno Sw (Eg) 1.6 I 16V 1996>2002, Baleno Sw (Eg) 1.6 I 16V 1996>2002, Baleno Sw (Eg) 1.6 I 16V 4X4 1996>2002, Baleno Sw (Eg) 1.6 I 16V 4X4 1996>2002, Grand Vitara I (Ft, Ht) 2.0 4X4 1998>2003, Grand Vitara II (Jt, Te, Td) 2.0 2005>2015, Swift II Sedan (Ah, Aj) 1.6 1989>1991, Swift II Sedan (Ah, Aj) 1.6 4Wd 1989>1991, Swift II Sedan (Ah, Aj) 1.6 I 1990>2001, Swift II Sedan (Ah, Aj) 1.6 I 4Wd 1990>2001

GC5105 // NEW //

FEATURES/ CARACTERÍSTICAS:

...

REPLACES / REEMPLAZA:

Suzuki: 33700-78470, 3370078470, 3370082011, 33700-84100, 3370084100, 33705-60B10, 3370560B10, 33705-60E00, 3370560, 33705-86000, 3370586000, 33710-50G10, 33710-50G10, 3371050G10, 33710-60E10, 3371060000000000000; **Valeo:** 346536

APPLICATION / APLICACIÓN:

SUZUKI: Swift II (Hatch) 1.0 i 1989>2001 Gasoline

GC5107 // NEW //

FEATURES/ CARACTERÍSTICAS:

...

REPLACES / REEMPLAZA:

GM: 295613811

APPLICATION / APLICACIÓN:

GM: Swift 1.6 2006> Petrol (Gasoline)

GC5108 // NEW //

FEATURES/ CARACTERÍSTICAS:

...

REPLACES / REEMPLAZA:

Mazda: 8AU3-18-140, 8BU5-18-140, 8BU5-18-140A; **NGK:** 2917

APPLICATION / APLICACIÓN:

MAZDA: B-Series Pickup 2.6 12V 4WD 1999>2006 Petrol (Gasoline)

GC5109 // NEW //

FEATURES/ CARACTERÍSTICAS:

...

REPLACES / REEMPLAZA:

Mazda: 8BB318140A

APPLICATION / APLICACIÓN:

MAZDA: 323 DX/LX 1986>1987 Petrol (Gasoline)

GC5110 // NEW //

FEATURES/ CARACTERÍSTICAS:

...

REPLACES / REEMPLAZA:

Mazda: 8BGA-18-140, 8BGA18140, 8BGA18140A; **Valeo:** 346493; **NGK:** 9917

APPLICATION / APLICACIÓN:

MAZDA: 626 1.6 / 2.0 1987>1998 Petrol (Gasoline), 929 II 2.0 1984>1987 Petrol (Gasoline)



GC5111 // NEW //

FEATURES/ CARACTERÍSTICAS:

...

REPLACES / REEMPLAZA:

Mazda: FP3918010

APPLICATION / APLICACIÓN:

MAZDA: 626 Matsuri 2.0 1993>1995 Petrol (Gasoline)



GC5112 // NEW //

FEATURES/ CARACTERÍSTICAS:

...

REPLACES / REEMPLAZA:

Mitsubishi: MD030936, MD030938, MD080536, MD080566, MD080568, MD080569, MD109181, MD997313, MD997318, MD997319, MD997328, MD997349, MD997349, MD997387, MD997506; **Valeo:** 346329, BREMI: 3A00/108

APPLICATION / APLICACIÓN:

MITSUBISHI: Colt Ii (C1_A) 1.2 El,Gl (C15A) 1984>1984, Colt Ii (C1_A) 1.2 El,Gl (C15A) 1986>1986, Colt Ii (C1_A) 1.5 Glx (C12A) 1985>1985, Colt Ii (C1_A) 1.5 Glx (C12A) 1984>1984, Colt Iii (C5_A) 1.3 (C51A) 1988>1988, Colt Iii (C5_A) 1.3 Gl (C61A) 1988>1988, Colt Iii (C5_A) 1.5 Cat (C52A) 1990>1990, Colt Iii (C5_A) 1.5 Glxi (C52A) 1988>1988, Galant Ii (A16_) 2.0 GlS (A163) 1980>1980, Galant Ii (A16_) 2.0 Turbo Eci (A164) 1982>1982, Galant Iii (E1_A) 2.0 GlS (E15A) 1986>1986, Galant Iii (E1_A) 2.0 GlS (E15A) 1984>1984, Galant Iii (E1_A) 2.0 Turbo Eci (E15A) 1984>1984, Galant Iv (E3_A) 2.0 (E39A, E38A, E33A) 1989>1989, Galant Iv (E3_A) 2.0 4Wd (E33A, E38A, E39A) 1989>1989, Galant Iv Sedan (E3_A) 2.0 (E39A, E38A, E33A) 1987>1987



GC5113 // NEW //

FEATURES/ CARACTERÍSTICAS:

...

REPLACES / REEMPLAZA:

Mitsubishi: MD023742, MD976523, MD997351, MD997357, MD997360; **Mazda:** 0000-18-101A; **Valeo:** 346251; **Bosch:** 0 986 357 196; **NGK:** 9293

APPLICATION / APLICACIÓN:

MITSUBISHI: Pajero Shogun 2.6 1983>1990 Petrol; **VW:** LT-2850 1975>1996, LT 40-55 1975>1996



GC5114 // NEW //

FEATURES/ CARACTERÍSTICAS:

...

REPLACES / REEMPLAZA:

NGK: SCN06

APPLICATION / APLICACIÓN:

HYUNDAI: Atos Prime, Accent Verna, Accent Gyro Petrol (Gasoline)



GC5115 // NEW //

FEATURES/ CARACTERÍSTICAS:

...

REPLACES / REEMPLAZA:

Daewoo: 96497773, 96460220, 96211948, 96 211 948, P96211948; **Hitachi:** 134236; **Valeo:** 346341; **Bosch:** 0 986 MG0 965; **NGK:** 44277

APPLICATION / APLICACIÓN:

GM: Cruze 1.6 LXT/LDE 2009> Petrol (Gasoline);

DAEWOO: Lanos 1.6 16V 1997>, Nubira 1.6 16V 1997>1999, Tacuma 1.6/1.6 SX 2000>2004 Petrol (Gasoline)



GC5116 // NEW //

FEATURES/ CARACTERÍSTICAS:

...

REPLACES / REEMPLAZA:

Daewoo: 96305387, 9A418150B; **Hitachi:** 134239; **Valeo:** 346355; **NGK:** 8275; **Bosch:** 0 986 356 980

APPLICATION / APLICACIÓN:

GM: Aveo/Kalos 1.4 2005>2008, Aveo LX5 1.4 2005> Petrol (Gasoline);

DAEWOO: Kalos 1.4 2002>, Lanos 1.3/1.5 1997> Petrol (Gasoline)

GC5117 // NEW //

FEATURES/ CARACTERÍSTICAS:

...

REPLACES / REEMPLAZA:

GM: 231501451984

APPLICATION / APLICACIÓN:

GM: N200 2008>2012 Petrol (Gasoline)

GC5118 // NEW //

FEATURES/ CARACTERÍSTICAS:

...

REPLACES / REEMPLAZA:

Daewoo: 96450249; **GM:** 96 450 249; **Hitachi:** 134119; **Valeo:** 346038; **NGK:** 6022

APPLICATION / APLICACIÓN:

DAEWOO: Nubira 1.6 2003> Petrol (Gasoline);

GM: Lacetti 1.4 16V / 1.6 2005> Petrol (Gasoline)

GC5119 // NEW //

FEATURES/ CARACTERÍSTICAS:

...

REPLACES / REEMPLAZA:

GM: 25183557, 96651945, 96 984 145; **NGK:** 44341; **Hitachi:** 134375

APPLICATION / APLICACIÓN:

GM: Aveo 1.2 2006>, Spark 1.0/1.2 2010> Petrol (Gasoline)

GC5120 // NEW //

FEATURES/ CARACTERÍSTICAS:

...

REPLACES / REEMPLAZA:

Hyundai: 2746039010

APPLICATION / APLICACIÓN:

HYUNDAI: XG300 3.0L V6 A/T 2001, XG350 3.5L V6 A/T 2002>2003 Petrol (Gasoline)

GC5121 // NEW //

FEATURES/ CARACTERÍSTICAS:

...

REPLACES / REEMPLAZA:

Mazda: 26714066

APPLICATION / APLICACIÓN:

MAZDA: 6 2002>2008 Petrol (Gasoline)

GC5122 // NEW //

FEATURES/ CARACTERÍSTICAS:

...

REPLACES / REEMPLAZA:

GM: 24512522; **Contacto:** 224531324

APPLICATION / APLICACIÓN:

GM: N300 2008> Petrol (Gasoline)

GC5123 // NEW //

FEATURES/ CARACTERÍSTICAS:

...

REPLACES / REEMPLAZA:

Zotye: 2471Q3707802

APPLICATION / APLICACIÓN:

ZOTYE: Nomad 1.3 2005>2016 Petrol (Gasoline)



EMS COMPONENTS | SISTEMA DE CONTROL DE MOTOR

IGNITION MODULE | MÓDULO DE ENCENDIDO

AUDI
GA2211

FEATURES / CARACTERÍSTICAS:
REPLACES / REEMPLAZA:
Audi: 4D0997351, 8D0905351; **Mobiletron:** IG-B022

APPLICATION / APLICACIÓN:
AUDI: A3 1.8T 96>03, A4, A4 Avant 1.8T 94>01, A6, A6 Avant 1.8T 97>05, A8 94>02;

SKODA: Octavia 1.8T 96>10, Octavia Break 1.8T 98>10

AUDI
GA2351 // NEW //

FEATURES / CARACTERÍSTICAS:
REPLACES / REEMPLAZA:
Audi: 4A0905351A; **Bosch:** 0 227 100 209, 0 227 100 210; **Hitachi:** DIS4-05; **Transpo:** BM1209; **Meat & Doria:** 10063

APPLICATION / APLICACIÓN:
AUDI: A4 MK 1 Saloon 2.6/2.6 quattro/S4 quattro/2.8/2.8 quattro 1995>2000, A4 MK 1 Avant/Estate 2.6/2.6 quattro/S4 quattro/RS4 quattro 1996>2001, A6 MK 1 Saloon/Avant/Estate 2.6 quattro/2.8 quattro/S6 Turbo quattro 1994>1997, A6 MK 2 Saloon/Avant/Estate 2.7 T/2.7 T quattro 1997>2005, A6 Allroad MK 1 2.7 T quattro 2000>2005, A8 MK 1 Saloon 2.8 1994>1996, Coupe S2 quattro 1992>1996, Cabriolet 1.8/2.0 E/2.0 16V/2.6/2.8 1992>2000, 80 MK 4 Saloon S2 quattro 1993>1994, 80 MK 4 Avant/Estate S2 quattro/R S2 quattro 1993>1995, 100 MK 4 Saloon S4 Turbo quattro 1991>1994

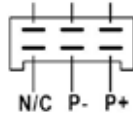
BOSCH
GA2005

FEATURES / CARACTERÍSTICAS: Magnetic Pick-up

REPLACES / REEMPLAZA:
Bosch: 9 220 087 003, 9 220 087 004, 9 220 087 005, 9 220 087 006, BM 100; **Mobiletron:** IG-D1989; **Magneti Marelli:** MI530700

APPLICATION / APLICACIÓN:
GM: Caminhões 11000, 12000, 13000, 14000, 19000, 21000, 22000, C20, C40, C60, C70, C90, Caravan 2.5, 4.1, Chevette 1.4, 1.6, Hatch 1.4, 1.6 Chevy 500, 1.6, Ipanema 1.8, 2.0, Kadett 1.8, GS 2.0, Marajo 1.4, 1.6, Opala 2.5, 4.1;

FIAT: 147 1.3, Pick-up 1.3, Fiorino 1.3, Furgão 1.3, 1.5, Pick-up 1.3, 1.5, Elba 1.3, 1.5, Oggi 1.3, Panorama 1.3, Premio 1.3, 1.5, Spazio 1.3, Uno 1.3, 1.5, Mille 1.0;

FORD: Bellina II 1.8, Del rey 1.8, Escort 1.3, 1.6, 1.8, Pampa 1.6, 1.8, 1.6 4x4, Royale 1.8, 2.0, Verona 1.6, 1.8, Versailles 1.8, 2.0, Gurgel, Tocantins 1.6L, TR;

VW: Apollo 1.8, Brasília 1.3, Fusca 1.3, 1.6, Gol 1.3, 1.6, 1.8, Kombi 1.6, Parati 1.6, Passat 1.6, 1.8, Quantum 1.8, 2.0, Santana 1.8, 2.0, Transporter 1.6, Voyage 1.5, 1.6

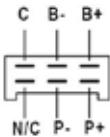
BOSCH
GA2005N

FEATURES / CARACTERÍSTICAS: Magnetic Pick-up

REPLACES / REEMPLAZA:
Bosch: 9 220 087 004, 9 220 087 005, 9 220 087 006, BM 100; **Magneti Marelli:** MI530700

APPLICATION / APLICACIÓN:
GA2005 same application.

BOSCH
GA2013

FEATURES / CARACTERÍSTICAS: System: Amplifier

REPLACES / REEMPLAZA:
Bosch: 9 220 087 011, 9 220 087 013; **Magneti Marelli:** MI530701; **VW:** 305.905.351.1

APPLICATION / APLICACIÓN:
VW: Gol 1.6, 1.8, Parati I 1.6, 1.8, Quantum 1.8, 2.0, Santana 1.8, 2.0, Saveiro 1.6, 1.8 Voyage 1.6, 1.8;

LADA: Laika 1.5, 1.6, Niva 1.5, 1.6;

MIURA: Top Sport 2.0

BOSCH
GA2013N

FEATURES / CARACTERÍSTICAS: System: Amplifier

REPLACES / REEMPLAZA:
Bosch: 9 220 087 011, 9 220 087 013; **Magneti Marelli:** MI530701; **VW:** 305.905.351.1

APPLICATION / APLICACIÓN:
GA2013 same application.

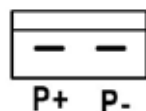
BOSCH
GA2019

FEATURES / CARACTERÍSTICAS: Inductive Pick-up

REPLACES / REEMPLAZA:
Bosch: 9 220 087 019; **Fiat:** 7075200

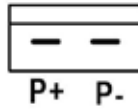
APPLICATION / APLICACIÓN:
FIAT: Premio, Elba e Pick-up lx todos c/motor 1.6 e Uno c/motor 1.6r todos a gas. e a alc. após 01/90

BOSCH
GA2026

FEATURES / CARACTERÍSTICAS: Magnetic Pick-up

REPLACES / REEMPLAZA:
Bosch: 9 220 087 026; **Fiat:** 7076168

APPLICATION / APLICACIÓN:
FIAT: Uno Mille, Elba, Prémio, Uno 1.5

BOSCH
GA2030

FEATURES / CARACTERÍSTICAS: Hall System

REPLACES / REEMPLAZA:
Bosch: 1 227 030 030; **Audi / VW:** 867 905 352; **Lucas:** DAB 954; **Telefunken:** 339 700; **Valeo:** CD 877; **Magneti Marelli:** 940038504, 940038504010, MI530702

APPLICATION / APLICACIÓN:
VW: Logus, Pointer, Apollo, Pollo;

FORD: Escort, Verona;

IMPORTADOS: Audi 80 2.0, 1.6, Multivan, Passat 1.6, Polo, Vento

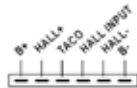
BOSCH
GA2049

FEATURES / CARACTERÍSTICAS: Hall System

REPLACES / REEMPLAZA:
Audi / VW: 86790535; **Bosch:** 1 227 030 049; **Magneti Marelli:** 940038507, 940038507010; **Valeo:** CD878; **Mobiletron:**
IG-H013; Magneti Marelli: MI530704

APPLICATION / APLICACIÓN:
FORD: Escort CHT 1.6;

VW: Gol 1000, Golf, Passat, Voyage, Apollo;

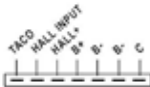
IMPORTADOS: VW Passat 1.6, Polo 1050, Transpoter, Vento

BOSCH
GA2138

FEATURES / CARACTERÍSTICAS: Hall System

REPLACES / REEMPLAZA:
Bosch: 0221600001, 0221600006, 0221600008, 0221600011, 0227100100, 02271000101, 02271000103, 02271000104, 02271000113, 02271000116, 02271000118, 02271000137, 02271000138, 02271000139, 02271000920, 02271000921, 02271000922, 02271000923, 02271000924, 1227000034, 1227000001, 1227000004, 1227022008, 1227030046; **Audi / VW:** 211905351A, 211905351B, 211905351D, 211905351E; **Mobiletron:** IG-H004H; **Magneti Marelli:** MI530705

APPLICATION / APLICACIÓN:
VW: Gol, Saveiro;

FIAT: Tempra 16V;

IMPORTADOS: Alfa Romeo, Audi, BMW, Mercedes Benz, Opel, Porsche, Saab, Seat, Vauxhall, Volvo, **VW,** Daimler

BOSCH
GA2140

FEATURES / CARACTERÍSTICAS: Magnetic Pick-up

REPLACES / REEMPLAZA:
Bosch: 0 227 100 140, 1 127 022 017, 1 127 022 018, 1 227 022 017, 1 227 022 018, 1 227 022 031, 1 227 062 018, 1 237 010 028, 1 237 010 029, 1 237 010 031, 1 237 010 038

APPLICATION / APLICACIÓN:
FORD: Escort 1.1/ 1.1 Turnier, 1.3/ 1.3 Cabrio/ 1.3 Express/ 1.3 Turnier, 1.4/ 1.4 Cabrio/ 1.4 Turnier/ 1.4 Express, 1.6/ 1.6 Cabrio/ 1.6 RS Turbo/ 1.6 Turnier/ 1.8D/ 1.8D Turnier, Fiesta 1.0/ 1.1/ 1.4, Orion 1.3/ 1.3i/ 1.4/ 1.6/ 1.6i;

PEUGEOT: 106 1.1/ 1.1i/ 1.4/ 1.4i, 205 1.0/ 1.1/ 1.1i/ 1.3/ 1.4/ 1.4i/ 1.4i XT/ GT/ 1.6 CTI/ 1.6 GTI/ 1.9 CTI/ 1.9 GTI, 306 1.4/ 2.0i 16V, 309 1.1/ 1.1i/ 1.4/ 1.6/ 1.6i/ 1.9, 405 1.4/ 1.6/ 1.6i/ 1.8/ 1.9/ 1.9i/ 1.9 TD/ 2.0, 405 Break, 605 2.0, Boxer 2.0;

CITROËN: AX 1.0/ 1.1/ 1.1i/ 1.4/ 1.4i, BX 1.4/ 1.4i, C15E 1.1/ 1.4/ 1.4i, XM 2.0/ 2.0i, ZX 1.1/ 1.1i/ 1.4/ 1.4i

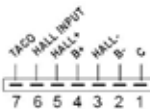
BOSCH
GA2142

FEATURES / CARACTERÍSTICAS: Hall System

REPLACES / REEMPLAZA:
Bosch: 0 227 100 142, 0 227 100 143, 0 227 100 147, BM342; **Audi:** 191905351A, 191905351B, 191905351C; **Mobiletron:** IG-H005H; **Magneti Marelli:** MI530706

APPLICATION / APLICACIÓN:
VW: Apollo 1.8, Fusca 1.6 >08/93 / (alc.), Gol 1.0 >1/92/1.6, Voyage 1.6, Parati 1.6, Saveiro 1.6 >11/92 / (alc.), Gol 1.8 GTS, Parati 1.8 GTS >03/92, Gol 1.8, Voyage 1.8, Parati 1.8, Saveiro 1.8 >03/92, Gol 1.8, Voyage 1.8, Parati 1.8, Saveiro 1.8 (alc.) >03/92, Kombi 1.6 >08/93 / (alc.), Logus 1.6 CL, GL (alc.) / 1.8 CL, GL, GLS (alc.) >02/93, Santana 1.8, Quantum 1.8 >03/92, Santana 1.8, Quantum 1.8 (alc.) >02/93, Santana 2.0, Quantum 2.0 >03/92, Santana 2.0, Quantum 2.0 (alc.) >03/92;

AUDI: 80 2.0 >10/90 a 08/91, 80 2.0 Quattro 10/90 a 08/91;

FORD: Escort (93) 1.6 L, GL >01/93, 1.8, 1.8(alc.), Escort (93) 1.8 GHIA >01/93, (alc.) >01/93, 1.8 XR3 >01/93, 2.0 >01/93, (93) 2.0 (alc.) >01/93, Escort 1.6, (alc.), Hobby >01/93, (alc.), Escort 1.6 L, GL (alc.), Escort 1.8 >03/92, Escort 1.8 XR3, Escort 2.0 / (alc.), Pampa 1.6 / (alc.), Pampa 2.0 >01/93, Pampa 2.0 (alc.), Verona (93) 2.0 >01/93 / (alc.), Verona 1.6 / (alc.) / 1.8 / 2.0 / (alc.), Versailles 1.8, Royale 1.8 >01/93 / (alc.), 2.0 >03/92 (alc.)

BOSCH
GA2210

FEATURES / CARACTERÍSTICAS: ECU controlled

REPLACES / REEMPLAZA:

Ignition Module of GC4210

APPLICATION / APLICACIÓN:
AUDI: A3 1.6 99-06;

VW: Fox 1.0, 1.4, 1.6 Total Flex 03>, Polo/ Sedan, Total Flex 04>, Gol III, IV, V 1.0 Mi, 1.0 Turbo, 1.6, 05>, Kombi 1.4 Total Flex 06>, Golf IV 1.6 06-08, Parati 1.0 Mi 16V]

BOSCH
GA2310 // NEW //

FEATURES / CARACTERÍSTICAS:
REPLACES / REEMPLAZA:
Huco: 138420

APPLICATION / APLICACIÓN:
Audi: A1 1.2 2010>2015, A1 sportback 1.2 2012>2015, A2 hatch 1.4 2000>2005, A3 MK 1 hatch 1.6;1.8 1996>2003, A3 MK 2 hatch 1.2 1.6 2010>2012, A3 convertible 1.2, 1.6 2010>2013, A4 mk 1 saloon/avant/estate 1.6 1994>2001, A4 MK 2 saloon/avant/estate 1.6 2000>2004, A4 MK 3 saloon/avant/estate 1.6 2004>2008;

Seat: Alhambra MPV 2.0 1996>2010, Altea MPV 1.2, 1.6 2014, Altea XL MPV 1.2, 1.6 2009>2010, Arosa hatch 1.0, 1.4 1997>2004, Cordoba MK 1 saloon/Estate 1.0, 1.4 1996>2002, Cordoba MK 2 saloon 1.6, 2.0 2002>2009, Exeo 1.6, 1.8 2009>2010, Exeo ST 1.6, 1.8 2009>2010, Ibiza MK 2 hatch 1.0, 1.4 1996>2002, Ibiza MK 4 hatch 1.4, 1.6, 2.0 2002>2009, Ibiza MK 5 hatch 1.2 2010>2012, Ibiza sportcoupe 1.2 2010>2012, Ibiza IV ST 1.2 2010>2012, Inca van 1.4 1995>2003, Leon MK 1 hatch 1.4, 1.6 1.8 1999>2006, Leon MK 2 hatch 1.2, 1.6 2005>2012, Toledo MK 2 saloon 1.4, 1.6, 1.8 1998>2006, Toledo MK 3 1.6 2004>2009, Toledo IV 1.2 2012>2015;

Skoda: Fabia MK 1 hatch/saloon/estate 1.4, 2.0 1999.2008, Octavia MK 1 hatch/estate 1 1.4, 1.6, 2.0 1997>2007, Octavia MK 2 hatch/estate 1.6 2008>2013, SuperB MK 1 saloon 2.0 2001>2008;

Vw: Bora saloon/estate 1.4, 1.6, 1.8, 2.0 2000>2005, Caddy MK 2 estate 1.4 2000>2004 Caddy MK 2 van 1.4 1995>2004, Caddy III estate 1.6 2004>2015, Caddy MK 3 van 1.6 2004>2005, Golf MK 4 hatch/estate/cabriolet 1.4, 1.6, 2.0 1997>2006, Golf MK 5 estate 1.6 2007>2009, Lupo hatch 1.4, 1.6 1998>2005, New beetle 1.6,2.0 1998>2010, New beetle convertible 1.6 2003>2010, Passat MK 5 saloon/estate 1.6 1997>2005, Polo MK3 hatch 1.6 1998>1999, Polo classic MK 3 saloon 1.4, 1.6 1995>2001, Polo MK 3 estate 1.4 1998>2001, Polo MK 3F hatch 1.0, 1.4, 1.6 1999>2001, Polo MK 4/4F hatch 1.4 2001>2008, Touran 1.6 2003>2010, Transporter T5 minibus/van/flatbed 2.0 2003>2015

BOSCH / CHRYSLER
GA2850

FEATURES / CARACTERÍSTICAS: Magnetic pick-up

REPLACES / REEMPLAZA:
Chrysler: 3438850, 3874020, 4111850, 3656127, 3656128, 3656900, 3755550, 4111850, 3874020;

White: 31-2759157;

Lucas: DAB591, DAB951;

Standard: LX-101; **Bosch:** 9 290 010 654

APPLICATION / APLICACIÓN:
CHRYSLER: 72-89, Avenger, Centura, Solara, Sunbeam;

DODGE: Truck, Valiant;

TALBOT; SIMCA; PLYMOUTH
BOSCH / CHRYSLER
GA2900

FEATURES / CARACTERÍSTICAS: Magnetic pick-up

REPLACES / REEMPLAZA:
Chrysler: 1230938, 3656900, 1230939, 3755555, 3656128; **Magneti Marelli:** 940038516; **Bosch:** 9 290 010 655;

Mobiletron: IG-C850

APPLICATION / APLICACIÓN:
CHRYSLER: Avenger, Centura, Solara, Sunbeam, Valiant; TALBOT; SIMCA;

DODGE: B Van 72-78, D/W Pickup, HD, Trucks, CB300 74-78, P200 1972, P300, RD 1978, Pickup, Ramcharger 74-77;

PLYMOUTH: PB Van 73-78, Trailduster 75-78

CHRYSLER
GA2910

FEATURES / CARACTERÍSTICAS: 12V

REPLACES / REEMPLAZA:
Chrysler: MD607478; **Mazda:** 8574-24-910; **Mobiletron:** IG-M001; **Transpo:** ICM117, MM806; **Regitar:** M001

APPLICATION / APLICACIÓN:
CHRYSLER: 1982>1985;

DODGE: 1981>1987;

FORD: 1981>1982;

MITSUBISHI: 1983>1983;

PLYMOUTH: 1981>1987;

MAZDA: 323 II Hatchback, 323 II, 626 II Hatchback, 626 II, 626 III Station Wagon

CITROËN

GA2790
FEATURES / CARACTERÍSTICAS: 12V

REPLACES / REEMPLAZA:
Nissan: 22020-D0200, 22020-V5400, 22020-V5401; **Transpo:** HM703, ICM555; **Mobiletron:** IG-NS005; **Regitar:** NS005

APPLICATION / APLICACIÓN:
NISSAN: 200SX 1982>1983, 720 1983>1985, Stanza 1985>1986

DELCO

GA2089
FEATURES / CARACTERÍSTICAS: 12V

REPLACES / REEMPLAZA:
Delco: D572; **GM:** 16176089; **Transpo:** DM572, ICM380

APPLICATION / APLICACIÓN:
CHEVROLET: S10 Pickup 1995;

GMC: Senoma Pickup 4.3 1994>1995

DELCO

GA2485
FEATURES / CARACTERÍSTICAS: 14V

REPLACES / REEMPLAZA:
GM: 10482821, 1894308, 1894485, 1987492, 19180772; **Delco:** 1894308; **Transpo:** DM1918, ICM331; **Mobiletron:** IG-D1918; **Regitar:** D1918

APPLICATION / APLICACIÓN:
BUICK: LeSabre 1980>1978, Regal 1981>1978, Riviera 1981>1979

CADILLAC: Commercial Chassis 1983>1979, DeVille 1979, Eldorado 1980>1979, Seville 1980>1978

CHEVROLET: Astro 1985, C10 1986>1982, C10 Suburban 1986>1981, C20 1986>81, C20 Suburban 1986>1981, C30 1986, G10 1986-1981, G20 1986>1981, G30 1986>1985, K10 1986>1981, K10 Suburban 1986>1985, K20 1985, K20 Suburban 1986>1985, K5 Blazer 1986>1981, Monte Carlo 1980

GMC: C1500 1986>1981, C1500 Suburban 1986>1982, C2500 1986>1981, C2500 Suburban 1986>1982, C3500 1986, Caballero 1986>1983, G1500 1986>1982, G2500 1986>1982, G3500 1986>1985, Jimmy 1986>1982, K1500 1986>1981, K1500 Suburban 1982, K2500 1985, Safari 1985

PONTIAC: Catalina 1980, Firebird 1981>1980, Grand LeMans 1980, Laurentian 1980, LeMans 1980, Parisienne 1980

DELCO

GA2544
FEATURES / CARACTERÍSTICAS: Hall System

REPLACES / REEMPLAZA:
Delco: 94404544; **Isuzu:** 8944045440; **Mobiletron:** IG-T003

APPLICATION / APLICACIÓN:
TOYOTA: Carina II, II Saloon 87>92, Corolla Liftback 87>95

DELCO / GM

GA2599
FEATURES / CARACTERÍSTICAS: Hall System

REPLACES / REEMPLAZA:
Delco: 10482803

APPLICATION / APLICACIÓN:
GM: Blazer, S10 4.3 V6

DELCO / GM

GA2986
FEATURES / CARACTERÍSTICAS: 4 PIN / Amplifier System

REPLACES / REEMPLAZA:
Delco: D1986A, D6134; **GM:** 10483139, 16191409

APPLICATION / APLICACIÓN:
BUICK; CADILLAC; CHEVROLET; PONTIAC

DELCO / GM
GA2959

FEATURES / CARACTERÍSTICAS: Magnetic pick-up

REPLACES / REEMPLAZA:
AMC: 8134117; **GM:** 10482823, 1978778;
Delco: 13017433, 16017433, 1978778, D1959;
Lucas: DAB700; **Magneti Marelli:** 940038520;
Opel: 1211560; **Valeo:** 245522, 2595010;
Chrysler: 8134117, J8134117; **Mobiletron:** IG-D1959H

APPLICATION / APLICACIÓN:
GM: Truck; OPEL: Vauxhall; AMC: 82-83;
BUICK: 82-86; CADILLAC: 83-84;
CHEVROLET: 82-86; **GMC:** 82-85; **JEEP:** 82-86; **OLDSMOBILE:** 82-86; **PONTIAC:** 82-86

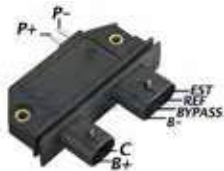
DELCO
GA2379

FEATURES / CARACTERÍSTICAS: Magnetic Pick-up

REPLACES / REEMPLAZA:
Delco: 16139379, 1989747, D1960A, D1980, DM 1980; **Mobiletron:** IG-D1980HV; **Magneti Marelli:** MI530707

APPLICATION / APLICACIÓN:
GM: Kadett 92/96, Monza 92/96, Ipanema;
IMPORTADOS: Buick, Chevrolet, GM-Trucks, Oldsmobile, Pontiac.

DELCO
GA2906

FEATURES / CARACTERÍSTICAS: Magnetic Pick-up

REPLACES / REEMPLAZA:
Delco: D1906, DM 1906; **Magneti Marelli:** MI530708

APPLICATION / APLICACIÓN:
ALFA ROMEO; AUTOBIANCHI; FSO; FIAT; GM; LANCIA; LEYLAND; PEUGEOT; RENAULT; ROVER; SEAT; FERRARI;
DELCO
GA2961

FEATURES / CARACTERÍSTICAS: Magnetic Pick-up

REPLACES / REEMPLAZA:
Delco: 13010892, 16010892, 196140049, 1977958, 1979107, 1979571, 6237754, D1957, D1958, D1961; **Mobiletron:** IG-D1961HV

APPLICATION / APLICACIÓN:
GM: Ascona C 1.6i /1.6, Astra 1.6i /1.6 Mot. C16NZ, Corsa A 1.3i /1.3, Corsa A 1.6 GSi, Kadett E 1.3i, Kadett E 1.6i, Vectra 1.6i C16NZ / E16N;
HONDA: Civic, CRXi 4-Cylinder Exc;
VAUXHALL: Astra, Belmont 1.3i, Astra, Belmont 1.6i, Cavalier 1.6i

DELCO
GA2990

FEATURES / CARACTERÍSTICAS: Magnetic pick-up

REPLACES / REEMPLAZA:
GM: 10469931, 10482827, 10496048, 10496269, 10496541, 10496784, 16139369, 16139389, 16140039, 1987465, 1987466, 10469931;
Isuzu: 8-10496-541-0;
Delco: 10496048, 10496269, D1990, D1943A, D1979, D1992;

Mobiletron: IG-D1980HV

APPLICATION / APLICACIÓN:
BUICK: 85-93; **CHEVROLET:** 85-95; **GEO:** 93-90;
GMC: 86-97; **ISUZU:** 87-96; **OLDSMOBILE:** 86-94;
PONTIAC: 82-85; **GM:** Trucks; **CADILLAC**
DELPHI
GA2987

FEATURES / CARACTERÍSTICAS:
REPLACES / REEMPLAZA:
Delphi: DAB132;
Nissan: 2202053J10;
Transpo: LM132

APPLICATION / APLICACIÓN:
NISSAN: Almera I Hatchback 1995>2000, Bluebird 1983>1990, Bluebird Hatchback 1985>1992, Prairie 1982>1988, Primera Hatchback 1990>1996, Primera Traveller 1990>1998, Stanza Hatchback 1981>1985, Sunny III Hatchback 1990>1995, Terrano II 1992>2007

DENSO
GA2825

FEATURES / CARACTERÍSTICAS:
REPLACES / REEMPLAZA:
Denso: 131300-1744;

Toyota: 89621-16070

APPLICATION / APLICACIÓN:
TOYOTA: Carina E Hatch 2.0 GLI/2.0 Gti 92>97, Carina E Saloon 2.0/2.0 Gti 92>97, Carina E Estate 2.0 GLI 93>97, MR2 Mk2 2.0 16V 89>99, Previa Mk1 2.4 90>00

FORD
GA2199

FEATURES / CARACTERÍSTICAS:
REPLACES / REEMPLAZA:
Ford: D6AB-12A199; **Motorcraft:** DY184; **Standard:** LX203; **Unipoint:** IMF02; **Transpo:** FM184

APPLICATION / APLICACIÓN:
Ford: Vehicles 1981>1997 (Fiesta Mk1 Hatch 1.6 XR2 81>83);

Jeep: Vehicles 1981>1987;

Lincoln: Vehicles 1982>1985;

Mercury: Vehicles 1981-1987

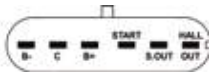
FORD
GA2297

FEATURES / CARACTERÍSTICAS: Magnetic pick-up

REPLACES / REEMPLAZA:
Ford: E8DZ-12A297-A, DY533, 86FB-12A297-AA, E7DF-12A297-A1A, E7DF-12A297-A2A, E7DZ-12A297-A, 6153090, E8DE-12297-AA, EDY19, E7ZA-12A297-A1A;

Motorcraft: DY533, EDY19; **Transpo:** FM533, ICM226; **Mobiletron:** IG-F533HV; **Regitar:** DY533

APPLICATION / APLICACIÓN:
FORD: Scorpio MK2 saloon/estate 2.0i 16V 1994>1998

FORD
GA2298

FEATURES / CARACTERÍSTICAS: Hall System

REPLACES / REEMPLAZA:
Ford: DY425, E3EF-12A297-A2A, E43Z-12A297-A, E8FZ-12A297-A, E3EZ-12A297-A1A, 1629456, E43ZP-12Z297-7A, E5RF-12A297-BA, E3EZ-12A297-A2A; **Lucas:** DAB 750; **Magneti Marelli:** 940038542, 940038543; **Motorcraft:** DY425, EDY7; **Valeo:** 245524;

Mobiletron: IG-F425HV

APPLICATION / APLICACIÓN:
FORD: 83-94, Light Truck 83-91,

LINCOLN: 84-86, **MERCURY:** 83-87;

MERKUR: 85-89, Truck

FORD
GA2401 // NEW //

FEATURES / CARACTERÍSTICAS:
REPLACES / REEMPLAZA:
Ford: F4FF-12A297-AA, 86FB-12A297-AA; **VW:** 377.907.401; **Mobiletron:** IG-F534HV; **Regitar:** DY534

APPLICATION / APLICACIÓN:
FORD: Transit 1988>1994, Aerostar 1991>1997, Bronco 1992>1993, E Van 1992>1996, F Pickup 1992>1996, Mustang 1994>1995, Probe 1993>1996, Ranger 1991>1997, Taurus 1991>1995, Thunderbird 1991>1997, Scorpio 2.0 i 16V 1994>1998;

MERCURY: Cougar 1991>1995, Sable 1991>1995; **LINCOLN:** Continental 1991>1994; **MAZDA:** B3000 1994

FORD
GA2515

FEATURES / CARACTERÍSTICAS:
REPLACES / REEMPLAZA:
Ford: E6SZ-12A297A, E7RZ-12A297A, E8FZ-12A297B, E9RF-12A297AA;

Motorcraft: DY515, DY597

APPLICATION / APLICACIÓN:
FORD: Granada Mk2 Saloon/Estate 2.0 79>85, Granada Mk3 Hatch/Saloon/Estate 2.0/2.4/2.8/2.9 85>94, Sierra Mk1 Hatch/Estate 2.0/2.8 82>86, Sierra Mk2 Hatch/Saloon/Estate 2.0/2.8/2.9 87>93, Transit 2.0i 91>94

FORD
GA2551

FEATURES / CARACTERÍSTICAS: 12V

REPLACES / REEMPLAZA:
Bosch: 1227010014, 1227022003;

Delco: 16010888;

Ford: 81SF12K059AA, 81SF12K059AB;

Mobiletron: IG-D1907H

APPLICATION / APLICACIÓN:
FORD: Escort III 80>86, Escort III, Kombi 80>85, Escort III, Cabriolet 83>85, Eescort 81, Express 81>86, Orion 83>86

FORD
GA2552

FEATURES / CARACTERÍSTICAS:
REPLACES / REEMPLAZA:
Ford: DY552, E9DE-12A297A2A, E9FF-12A297A1A, E9DF-12A297A2A, E9DZ-12A297A;

Transpo: FM552, ICM244

APPLICATION / APLICACIÓN:
FORD: Probe, Taurus

FORD
GA2624

FEATURES / CARACTERÍSTICAS:
REPLACES / REEMPLAZA:
Ford: F0JY-12A297-B;

Mazda: B303-18-V20, G601-18-V20, JE15-18-V20, JF01-18-251, 3F01-18-251, 829-18-V20;

Mitsubishi: J007X00812, J207, MD607409;

Faw Jiefang: IGM012

APPLICATION / APLICACIÓN:
MAZDA: 323 Mk3 Hatch/Saloon 1.6 GT 85>93

FORD
GA2679

FEATURES / CARACTERÍSTICAS:
REPLACES / REEMPLAZA:
Ford: F1PF-12A297AA, F1PZ-12A297A, F1SF-12A297C1A/C2A;

Motorcraft: DY645, DY667, DY679

APPLICATION / APLICACIÓN:
FORD: Aerostar, Bronco, E-150 Econoline, E-150 Econoline Club Wagon, E-250 Econoline, E-350 Econoline, E-350 Econoline Club Wagon, F-150, F-250, F-350, Mustang, Probe, Ranger, Taurus, Thunderbird (91>97);

LINCOLN: Continental (91>94);

MERCURY: Cougar, Sable (91>95)

GM
GA2344

FEATURES / CARACTERÍSTICAS: 12V

REPLACES / REEMPLAZA:
Nissan: 22020-15M00, 22020-15M20; **GM:** 94243344; **Honda:** 32120-PAO-661, 30120-PAO-661, 30120-PH4-005; **Isuzu:** 8-94243-344-0; **Transpo:** HM761, ICM515; **Mobiletron:** IG-NS002; **Standard:** 15800

APPLICATION / APLICACIÓN:
GM: S-10, Blazer 82>85;

HONDA: Accord, CRX, Civic, Prelude, Wagovan (old vehicles);

Isuzu: Amigo 89>93, Tropper 86>87;

Nissan: 310, Pulsar, Sentra 81>88, Sunny 82>91;

Subaru: L-Series/Leone 78>94

GM
GA2833

FEATURES / CARACTERÍSTICAS:
REPLACES / REEMPLAZA:
GM: 10482833, 12350351, 16139889, 1985342

Faw Jiefang: IGD1961HV

Transpo: DM1967

APPLICATION / APLICACIÓN:
BUICK: Skyhawk 2.0 87>88;

CHEVROLET: S10 2.5 85>91;

GMC: S15 2.5 85>90, Sonoma 2.5 91, Syclone 2.5 91;

OLDSMOBILE: Firenza 2.0 87>88;

PONTIAC: Grand AM 87>89, LeMans 1.6 88>89, Sunbird 2.0 87>91

GM

GA2928



FEATURES / CARACTERÍSTICAS: 14V

REPLACES / REEMPLAZA:

CHEVROLET: 10467202, 10472023, 10476627, 10489422, 10499430, 10499803, 10499883

ISUZU: 8-10467-202-0

NIEHOFF: DR424K

TRANSPO: DM1928, ICM346

DELPHI: GN10125

MOBILETRON: IG-D1928A

STANDARD: 15869

APPLICATION / APLICACIÓN:

CHEVROLET: Beretta Coupe 3.1 LT 1992>1993, Camaro 92 3.4 V6 1992>1998, Cavalier MK1 coupe 3.1 1989>1994, Cavalier convertible 3.1 1989>1991, Corsica 3.1 1987>1996, Lumina Saloon 3.4 Z34 1989>1994

OPEL: Monterey A 3.2 1992>1998

ISUZU: Trooper MK2 3.2 1991>1998

BUICK: Regal 3.1 1988>1991

GM

GA2952



FEATURES / CARACTERÍSTICAS: 12V

REPLACES / REEMPLAZA:

GM: 10498042, 16139869, 16140189, 1976908, 1977907, 1978617, 1987744, 1988500

APPLICATION / APLICACIÓN:

BUICK: 1981>1990;

CADILLAC: 1981>1995;

CHEVROLET: 1981>1991);

GMC: 1981>1986;

OLDSMOBILE: 1981>1990;

PONTIAC: 1981>1989;

FIAT: Regata 83>90

HITACHI

GA2056



FEATURES / CARACTERÍSTICAS: 6 PIN

REPLACES / REEMPLAZA:

HITACHI: RSB-56

APPLICATION / APLICACIÓN:

NISSAN: Sunny, Hatchback, Almera, X-Terra, Pathfinder, Sentra, Quest, Frontier.

LUCAS

GA2118



FEATURES / CARACTERÍSTICAS: Magnetic Pick-up

REPLACES / REEMPLAZA:

Lucas: 804 28, 84 403, 84 403D, 84 453, 84 896A, 84 950A, DAB 118, DAB 127, DAB 129, DAB 135; **Mobiletron:** IG-D1908H

APPLICATION / APLICACIÓN:

FORD: Escort 35,55 Van 1.3 CVH, Escort 35,55 Van 1.4 CVH, Escort 55 Van 1.6 CVH, Escort Combi 1.4 CVH, Escort III 1.3 CVH, Escort III 1.4 CVH, Escort III 1.6 CVH, Fiesta 1.4, Fiesta 1.6, Fiesta XR2 CHV, Orion 1.3 CVH, Orion 1.4 CVH, Orion 1.6 CVH;

RELIANT: Scimita RSS1 1.3, 1.4, 1.6;

MORGAN: Four-Ford 1600 OHC

LUCAS

GA2912



FEATURES / CARACTERÍSTICAS: System: Amplifier

REPLACES / REEMPLAZA:

Lucas: 549.87.086, DAB134, 803 34A, 84 890D, DAB126, LM126; **Mobiletron:** IG-D1912

GM: 90243618, 90360314, 90360315

OPEL: 1237334, 1237464

Magneti Marelli: MI530709

APPLICATION / APLICACIÓN:

GM: Corsa 1.0, 1.4 EFI 94/96

IMPORTADOS: Opel, Vauxhall.

MAGNETI MARELLI
GA2040

FEATURES / CARACTERÍSTICAS: **Magnethic Pick-up**

REPLACES / REEMPLAZA:

Magneti Marelli: 648 330 40, BKL4A, 58170107000, XM 640; **Mobiletron:** IG-FT001H; **Magneti Marelli:** MI530703

APPLICATION / APLICACIÓN:

IMPORTADOS: Fiat Duna, Panda, Uno, Lancia.

MITSUBISHI
GA2064

FEATURES / CARACTERÍSTICAS: **Magnetic pick-up**

REPLACES / REEMPLAZA:

Ford: DYE635, F0BZ-12A297-A, F0C66B740AA;

Mazda: BP01-18-251, B3F5-18-200; **Mitsubishi:** J701, J790T02971

APPLICATION / APLICACIÓN:

FORD: 90-97; **KIA:** 93-97;

MAZDA: 89-95;

MERCURY: Tracer 91-96

MITSUBISHI
GA2170



FEATURES / CARACTERÍSTICAS: **Magnethic Pick-up**

REPLACES / REEMPLAZA:

Mitsubishi: J170 9910A; **Mazda:** B541-18-V20; **Mobiletron:** IG-M007

APPLICATION / APLICACIÓN:

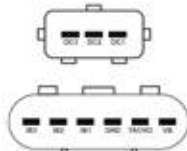
MAZDA

MITSUBISHI
GA2723

FEATURES / CARACTERÍSTICAS: **9 PIN / Position sensor command**

REPLACES / REEMPLAZA:

MITSUBISHI: J009T03471, J723T, J9T03471, MD160535; **Mobiletron:** IG-M016

APPLICATION / APLICACIÓN:

MITSUBISHI: (1992-1995), Pajero Sport, Pajero Full, L200, Triton, Mitsubishi 3000GT.

MITSUBISHI
GA2817

FEATURES / CARACTERÍSTICAS: **Magnetic pick-up**

REPLACES / REEMPLAZA:

Ford: E92Z-12A297-A, F02Z-12A297-A, DYE539, DYE589; **Mazda:** F82918V20, F2C718V20, FEFB18V20; **Mitsubishi:** 22020-G5110,

J007X00871, J117;

Kia: KK-150-18V-18D

APPLICATION / APLICACIÓN:

FORD;

MAZDA

MITSUBISHI
GA2852

FEATURES / CARACTERÍSTICAS: **Magnethic Pick-up**

REPLACES / REEMPLAZA:

Mitsubishi: J152, MD607814, MD611384; **Hyundai:** 27120-21020, 27120-21050; **Mazda:** AM15-18-V20, E730-12-4910;

Mobiletron: IG-M004H

APPLICATION / APLICACIÓN:

DODGE;

HYUNDAI;

MITSUBISHI;

MITSUBISHI
GA2853

FEATURES / CARACTERÍSTICAS: **Magnetic pick-up**

REPLACES / REEMPLAZA:

Ford: E8BZ-12A297-A, DYE524; **Mazda:** B30318V20, 830318V20; **Mitsubishi:** J207; **Motorcraft:** DYE524;

APPLICATION / APLICACIÓN:

MAZDA: B2200 2.2 89-93, B2600 2.6 1989, MPV 2.0 89-94, MX-3 1.6 91-94;

FORD: 88-89

MITSUBISHI
GA2506

FEATURES / CARACTERÍSTICAS: ...

REPLACES / REEMPLAZA:

Mitsubishi: J007X00971; Unipoint: IM 506; **Transpo:** MM 121; **Mobiletron:** IG-M009

APPLICATION / APLICACIÓN:

MITSUBISHI: Colt 88-00, Galant 88-96, Lancer 85-03, Pajero 88-90;

HYUNDAI: Coupe: 90-96, Sonata 91-93

NISSAN
GA2610

FEATURES / CARACTERÍSTICAS: **12V**

REPLACES / REEMPLAZA:

Niehoff: WA911; **Nissan:** 22020-61W00, 22020-61W01, 22020-61W02, 22020-61W03; **Mobiletron:** IG-NS006; **Regitar:** NS006;

Transpo: HM610, ICM556

APPLICATION / APLICACIÓN:

NISSAN: 720 1983>1986

NISSAN
GA2703



FEATURES / CARACTERÍSTICAS: **12V**

REPLACES / REEMPLAZA:

Nissan: 22020-D0200, 22020-V5400, 22020-V5401; **Transpo:** HM703, ICM555; **Mobiletron:** IG-NS005; **Regitar:** NS005

APPLICATION / APLICACIÓN:

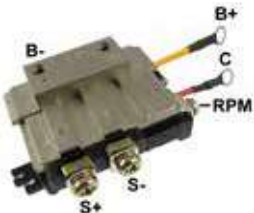
NISSAN: 200SX 1982>1983, 720 1983>1985, Stanza 1985>1986

TOYOTA
GA2126

FEATURES / CARACTERÍSTICAS: ...

REPLACES / REEMPLAZA:

Toyota: 7851 212310, 8961 212310/2320; **Mobiletron:** IG-T002

APPLICATION / APLICACIÓN:

TOYOTA: Corolla Liftback 83>89, Corolla FX Compact 84>88, Corolla Liftback/Compact 87>95, Corolla Station Wagon 87>92

TOYOTA
GA2020 // NEW //



FEATURES / CARACTERÍSTICAS:

REPLACES / REEMPLAZA:

Toyota: 89620-14210, 89620-1E11, 8962032020; **Denso:** 131300-0011; **Mobiletron:** IG-T001; **Transpo:** NM746, ICM608

APPLICATION / APLICACIÓN:

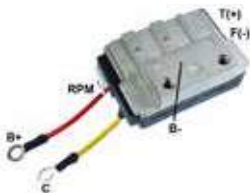
TOYOTA: Camry hatch/saloon 1.8 1983>1986, Corolla estate 1.3 1982>1987, Corolla hatch/saloon 1.6 1983>1988, Corolla hatch 1.6 GT 16V 1985>1987, Corolla coupe 1.6 GT 16V 1983>1987, Corolla hatch/saloon/estate 1.3i/1.6 1987>1993

TOYOTA
GA2440 // NEW //

FEATURES / CARACTERÍSTICAS: ...

REPLACES / REEMPLAZA:

Toyota: 89620-12440, 89620-12420, 89620-12680; **Mobiletron:** IG-T031

APPLICATION / APLICACIÓN:

TOYOTA: Corolla Hatch/Saloon 1.3/ 1.6 1983>1988, Celica Saloon 1.6 1973>1978, Celica Hatch 1.6 ST 1977>1981, Carina Mk2 Hatch/Saloon/Estate 1.6 1987>1989, Tercel Hatch 1.5 1982>1988



EMS COMPONENTS | SISTEMA DE CONTROL DE MOTOR

SPARK PLUG | BUJÍA

GV6R04I-11
GV5P81
GV7R95-10
GV
X
X
XX
X
-XX

Prefix | Prefijo

GAUSS Spark Plugs | GAUSS Bujía

Thermal degree | Grado termal

HOT | CALIENTE - 01, 02, 03, ..., 10 - COLD | FRÍO

Type of Spark Plugs | Tipo de Bujías

 Ex.: R = RESISTIVE | RESISTIVO
 Ex.: P = NO RESISTIVE | NO RESISTIVO

Numerical Sequence | Secuencia Numérica

01, 02, 03, ..., 98, 99

Standard | Estándar

 I = IRIIDIUM
 P = PLATINUM
 T = TRI-GROUND
 D = DOBLE-GROUND

 Gap between the electrodes (n° /10 > mm)
 Espacio entre los electrodos (n° /10 > mm)

Ex: 09 = GAP 0,9mm

Ex: 10 = GAP 1,0mm

Ex: 11 = GAP 1,1mm

Ps.: Unnumbered - Adjust gap as application

Obs.: Sin numerar - Ajuste el espacio como aplicación



Reference Table | Tabla de Referencia

GC7P85
Gasoline - Pack with 04 Spark Plugs | Gasolina - Paquete con 04 bujías
REPLACES / REEMPLAZA:
Bosch: B14YC; **Champion:** A2HC-9; **Denso:** X24EP-U9; **NGK:** DP8EA9

APPLICATION / APLICACIÓN:
HONDA: CBX 750F Indy, NX 350 Sahara, XIX 250R, 350R, XI 200, FZR 1000 - All, CB 400, 450DX, CNR 450SR 08/88>, CBX 150 Aero, NX 150, CG 125 Fan, CG Today, MI, Turuna 10/91>, CBX 200 Strada, CG Titan 125, NX 200, XR 200R >99, CG Cargo 10/91>99, XIR 97>00;

GV4P01 // NEW //
Pack with 04 Spark Plugs - Paquete con 04 bujías
REPLACES / REEMPLAZA:
NGK: BP4ES

APPLICATION / APLICACIÓN:
BENTLEY: Brooklands 6.7 R 1992>1997, Continental 6.75 V8 R 1991>1999;

CHRYSLER: Es Turbo 1989>1989, Le Baron Conversivel 2.2 I Turbo 1986>1990, Le Baron Sedan 2.2 I 1989>1994;

DAIHATSU: Charmant 1.3 1981>1987;

LADA: Niva Veículo Off Road Fechado 1700 I 1996>2006, Nova Sw 1700 1994>2012, Samara 1300 1996>1999, Samara 1500 1995>2006, Samara 1500 1987>1996, Samara Forma Sedan 1300 1995>2006, Samara Forma Sedan 1500 1994>2006;

LAND ROVER: Defender Station Wagon 3.9 V8 4X4 1998>2016, Discovery I 4.0 4X4 1993>1998, Discovery I 4.0 4X4 1993>1998, Range Rover I 3.9 Cat 4X4 1988>1994, Range Rover I 3.9 Cat 4X4 1988>1994, Range Rover I 3.9 Vogue Sei 4X4 1988>1994, Range Rover I 4.3 Vogue Lse 4X4 1992>1994, Range Rover li 3.9 4X4 1994>2002, Range Rover li 4.0 4X4 1995>2002, Range Rover li 4.6 4X4 1994>2002, Range Rover li 4.6 4X4 1998>2002;

MERCEDES-BENZ: Coupe 280 Ce 1977>1985, S-Class 450 Se, Sel 1973>1980, S-Class 560 Se, Sel 1985>1991, S-Class Coupé 560 Sec 1985>1991, S-Class Coupé 560 Sec 1985>1991, Sedan 280 E 1976>1981, Sedan 280 E 1976>1981, Sedan 280 E 1976>1985, Sedan 280 E 1976>1985;

NISSAN: Urvan Van Passenger 2.4 I 1989>1993;

RENAULT: Clio I 1.2 1996>1996, Rapid Furgão 1.2 1991>1998, Twingo I 1.2 1993>1996;

SEAT: Marbella 0.9 1987>1993, Marbella 0.9 1997>1998, Marbella 0.9 Cat 1990>1996, Marbella 0.9 Cat 1996>1998, Marbella Furgão 0.9 1987>1993, Marbella Furgão 0.9 Cat 1987>1993;

TOYOTA: Corolla 1.3 1982>1983, Crown 2.8 Si 1980>1983, Land Cruiser 3.9 1969>1975, Land Cruiser 4.2 1975>1986, Land Cruiser 4.0 1987>1992, Land Cruiser 4.0 1984>1987, Land Cruiser 4.2 1981>1988, Land Cruiser Pick-Up 4.2 1975>1986

GV5P81
Gasoline - Pack with 04 Spark Plugs | Gasolina - Paquete con 04 bujías
REPLACES / REEMPLAZA:
AC Delco: 44FFS; **Bosch:** W8AC, Sp 11, F000 KE0 P11; **Champion:** RL86C; **Denso:** W16FP; **NGK:** BP5HS

APPLICATION / APLICACIÓN:
VW: Brasília 1300/1600 - All, Fusca 1.2/1.3/1.5/1.6 "Short thread" 67>83, Gol and Saveiro 1.6 (Air cooled) "Short thread" - All, Kombi 1.3/1.5/1.6 "Short thread" - All, Variant 1600 (Air cooled)



GV5P82

Gasoline - Pack with 04 Spark Plugs | Gasolina - Paquete con 04 bujías

REPLACES / REEMPLAZA:

AC Delco: 44XLS; **Bosch:** W8DC, Sp 4, F000 KE0 P04; **Champion:** N11YC; **Denso:** W16EP-U; **NGK:** BP5ES

APPLICATION / APLICACIÓN:

FIAT: 147/ Panorama 1050/1300 - All, Elba 1.3/1.5/1.6 >91, Fiorino, Fiorino Pick-up 1050/1300/carb. >89, Fiorino and Fiorino Pick-up 1.3/1.5 88>91, Oggi 1050/1300/1415, Prêmio 1.3/1.5/1.6/carb. >91, Uno 1.0 carb., Mille 90>93, Uno 1.3 85>91, Uno 1.5R >91;

FORD: Belina, Corcel, Del Rey, Escort, Pampa, Royale, Versailles, Verona 1.8 (AP) >91;

RENAULT: R19 1.8 8V/ RT (F3P 704 A 707) 93>98, Twingo 1.2 8V (C3G) >06/97;

VW: Apollo 1.8 carb. (AP) - Coil with Pin 06/90>11/02, Gol 1.6/1.8/2.0 (AP), Saveiro, Voyage >91, Kombi 1.6 (without catalyst) "Long Thread" >91, Parati, Voyage 1.6/1.8 (AP) 82>91, Parati 2.0 (AP) >91, Passat 1.5/1.6/1.8 (AP) 74>86, Passat 1.6/1.8/2.0 (AP) 87>, Quantum, Santana 1.6/1.8/2.0 (AP) >91;



GV5R01

Gasoline - Pack with 04 Spark Plugs | Gasolina - Paquete con 04 bujías

REPLACES / REEMPLAZA:

AC Delco: CR44NS; **Bosch:** WR8KC; **Champion:** RN11YC; **Denso:** W16EXR-U; **NGK:** BPR5EY

APPLICATION / APLICACIÓN:

ASIA: Towner Coach, Towner Truck (Carb.), Towner Van (Carb.);

DAEWOO: Espero 2.0 SOHC 94>97;

FIAT: 147, Panorama 1050/1300 - All, Elba 1.3/1.5/1.6 >91, Fiorino, Fiorino Pick-up 1.0 8V (Carb. Inj.) 93>96, Oggi 1050/1300/1415, Prêmio 1.3/1.5/1.6 (Carb.) >91, Tempra 2.0 8V (Carb/SPI/ie) - All, Tipo 1.6 8V (MPI), Tipo 2.0 8V ie, Uno 1.0 (Carb.), Mille 90>;

FORD: Belina, Corcel, Del Rey 1.8 (AP) >91, Escort 1.6/1.8 (AP) Inj. 95>, Royale, Versailles 1.8/2.0 (AP) >91;

GM: Astra 2.0 8V SOHC (MPFI) 98>, Blazer 2.2 (EFI) Transf. behind the motor, Ipanema 1.8 (Carb.) >94, Ipanema 1.8/2.0 (EFI) - All, Ipanema 2.0 (MPFI) 94>98, Kadett 1.8/2.0 (EFI) - All, Monza 1.8/2.0 (Carb.) >94, Monza 1.8/2.0 (EFI) >94, Monza 2.0 (EFI) 95>, Vectra 2.0 8V/CD/GLS (MPFI), Zafira 2.0 8V 01>;

VW: Fusca 1.6 (with/ without catalyst) "Long Thread" 10/93>06/96, Gol 1.6/1.8/2.0 (AP) >96, Kombi 1.6 (with catalyst) "Long Thread" 92>, Parati 1.6/1.8 (AP) 82>95, Passat 1.5/1.6/1.8 (AP) 74>86, Passat 1.6/1.8/2.0 (AP) 87>, Voyage 1.6/1.8 (AP) 82>95



GV5R02-11

Gasoline - Pack with 04 Spark Plugs | Gasolina - Paquete con 04 bujías

REPLACES / REEMPLAZA:

Bosch: FR7KCX+, 0 242 236 541; **NGK:** BKR5EYA-11

APPLICATION / APLICACIÓN:

TOYOTA: Celica 2.2 16V (5S-FI) >91, Corolla 1.6 16V / VVTi DOHC (3ZZ-FE) 05/02>, Corolla 1.8 16V / VVTi DOHC (1ZZ-FE) 05/02>, Corona 2.0 / GL (3S-FE) 93>99, Fielder 1.8 16V / VVTi 04>, Paseo 1.5 16V (5E-FE) >95



GV5R03

Alcohol / Gasoline - Pack with 04 Spark Plugs | Alcohol / Gasolina - Paquete con 04 bujías

REPLACES / REEMPLAZA:

AC Delco: FR5LS; **Bosch:** F8DCOR, Sp 3, Sp 7, F000 KE0 P03 **Champion:** RC12YC; **Denso:** Q16PR-U; **NGK:** BCPR5ES

APPLICATION / APLICACIÓN:

FIAT: Tipo 1.6ie 8V (Gasoline) - All, Uno 1.4 Turbo (Gasoline) - All;

FORD: Belina, Corcel, Del Rey, Escort, Pampa, Verona 1.6 (CHT - AE - Alcohol/Gasoline) >91;

VW: Gol, Parati, Saveiro, Voyage 1.6 8V (AE - Alcohol/Gasoline) >91;



GV5R04

Gasoline - Pack with 04 Spark Plugs | Gasolina - Paquete con 04 bujías

REPLACES / REEMPLAZA:

AC Delco: R44CXLS; **Bosch:** WR8DC, Sp 4, F000 KE0 P04; **Denso:** W16EPR-U; **NGK:** BPR5ES

APPLICATION / APLICACIÓN:

DAEWOO: Espero 2.0 SOHC 94>97;

FIAT: Elba 1.5 Carb./1.6 92>, Fiorino, Fiorino Pick-up 1.0 8V (Carb. Inj.) 93>96, Fiorino, Fiorino Pick-up 1.5 (Inj.) - All, Prêmio 1.5/1.6 (Carb. Inj.) 92>, Tempra 2.0 8V (Carb/SPI/ie/Turbo) - All, Tempra SW 2.0 8V ie - All, Tipo 1.6 8V (MPI), 2.0 8V ie, Uno 1.0 Carb./1.0 ie, Mille 93>;

RENAULT: Mégane, Scénic 2.0 8V (F3R) 97>, Trafic 2.0 8V / Injeção (F3R) - All;



GV5R05-10

Gasoline - Pack with 04 Spark Plugs | Gasolina - Paquete con 04 bujías

REPLACES / REEMPLAZA:

AC Delco: R44LTS-10; **Bosch:** HR9DC-10, Sp 1, F000 KE0 P 1; **Champion:** RBN5EFS-10; **Denso:** T16EPR-U10; **NGK:** BPR5EFS-10

APPLICATION / APLICACIÓN:

FORD: Courier 1.3 8V Endura 10/97>08/99, Fiesta, Ka 1.0/1.3 Endura - All, Ranger 2.3 8V 11/96>10/97;



GV5R06

Gasoline / GNV - Pack with 04 Spark Plugs | Gasolina / GNV - Paquete con 04 bujías

REPLACES / REEMPLAZA:

Bosch: FR8ME+, Sp 24, F000 KE0 P24; **NGK:** LFR5B

APPLICACION / APLICACIÓN:

CITROËN: C4 2.0 16V / VTR (143 CV - EW10A / EW10J4) 06>, C4 2.0 16V / Pallas (143 CV - EW10A) 07>, C4 Picasso 2.0 16V (143 CV - EW10A) 09>, Grand C4 Picasso 2.0 16V (143 CV - EW10A) 09>, C5 2.0 16V / Break (143 CV - EW10J4-RFN) 01>, C5 2.0 16V - inj. (EW10J4) 03>, C5 2.0 16V (143 CV - EW10A) 06>, C8 2.0 16V (138 CV - EW10J4 - RFN) 03>, Xsara 2.0 16V (138CV - EW10J4 - RFN) 09/00>, Xsara Picasso 2.0 16V - inj. (138 CV - EW10J4) 01>

PEUGEOT: 307 2.0 16V (EW10J4 / EW10A) 03>, 307 CC 2.0 16V (EW10J4 / EW10A) 04>, 307 Sedan 2.0 16V (EW10A) 07>, 307 SW 2.0 16V (EW10J4 / EW10A) 03>, 407 2.0 16V (143 CV - EW10A) 09/06>, 407 SW 2.0 16V (143 CV - EW10A) 06>, 807 2.0 16V (138 CV - EW10J4) 04>05



GV5R07

Alcohol / Gasoline / GNV - Pack with 04 Spark Plugs | Alcohol / Gasolina / GNV - Paquete con 04 bujías

REPLACES / REEMPLAZA:

Bosch: FR8D+, Sp3, F000 KE0 P03, FR6D+, Sp7, F000 KE0 P07; **NGK:** BKR5E

APPLICACION / APLICACIÓN:

CHRYSLER (DODGE / JEEP): Cherokee 5.2 V8 93>96, Dodge Ram 5.9 V8 93>96, Grand Cherokee Limited 5.2 V8 93>96

CITROËN: Evasion 2.0 8V (XU10J2C) 95>01, Xantia 1.8 8V (XU7JP LFZ) 93>97, Xantia 2.0 8V (XU10J2R) 96>01, Xsara 1.8 8V - inj. (XU7JP) 97>01, ZX 1.8 8V (XU7JP) 96>98, Xsara 1.9 8V - inj. (XU9JA) / 2.0 8V - inj. (XU10J2C) 92>98

FIAT: Fiorino / Fiorino Pick-up 1.5 / mpi 97>, Fiorino / Fiorino Pick-up 1.5 / mpi 00>, Palio 1.5 8V / mpi - 1.6 8V / mpi - 1.6 8V / spi, Palio 1.5 8V / mpi, Palio 1.6 16V / mpi 00>, Palio Weekend 1.5 8V / mpi - 1.6 8V / mpi - 1.6 8V / spi, Palio 1.5 8V / mpi, 1.6 16V / mpi 00>, Siena 1.5 8V / mpi 99>, Siena 1.6 8V / spi - 1.6 8V / mpi, Siena 1.6 16V / mpi 00>, Strada 1.5 8V / mpi - 1.6 8V / mpi - 1.6 8V / spi, Strada 1.5 8V / mpi, Strada 1.6 16V / mpi 00>, Uno 1.4 / Turbo - 1.4 (with AC) / Turbo

GM: Astra 1.8 / 2.0 8V - SOHC sextavado 16 mm (C20NE) 95

KIA MOTORS: Clarus 1.8 DOHC (T8) 06/96>04/00

MERCEDES BENZ: C230 2.3 07/95>, E230 2.3, E280 2.8 24V 96>02/97, E320 3.2 (M104.995) 06/95>05/99, E420 4.2 32V V8 96>03/97

PEUGEOT: 106 1.0 8V / Kid / XN / Soleil (TU9M) 07/92>06/95, 106 1.0 / Kid / XN / Soleil (TU9M) 07/95>, 106 1.0i 8V (TU9M) 96>, 106 1.4i / XT (TU3MC) 07/92>06/95, 205 1.0 / Junior (TU9M) 07/92>, 205 1.4 / Xsi (TU3MC) - 1.4i / CJ convertible (TU3MC / TU3M) 07/92>06/95, 205 2.0 /CTI convertible (XU9JP/ XU9JA/ XU9J1) 07/92>, 306 1.8i / XN / XR / SR / SL / Cabrio (XU7JP), 306 2.0 / Xsi / Cabrio (XU10J2) 03/95>, 405 1.6 8V / GL/GR (XU5JP) 07/94, 405 1.6 8V / GL/GR (XU5M3) 07/92>06/94, 405 1.8 / SR/GR (XU7JP) 07/92>, 405 2.0i / SRI / STI / Break (XU10J2) 07/92>03/95, 605 2.0 / SRI (XU10J2) 07/92>07/94, 806 2.0 (XU10J2C) 03/94>06/95



GV5R08-11

Gasoline / GNV - Pack with 04 Spark Plugs | Gasolina / GNV - Paquete con 04 bujías

REPLACES / REEMPLAZA:

BOSCH: WR8D+, Sp4, F000 KE0 P04; **NGK:** B6S

APPLICACION / APLICACIÓN:

CHRYSLER (DODGE / JEEP): Cherokee Sport 3.7 V6 (211 CV) 10/01>

FIAT: Freemont 2.4 16V / DOHC Dual VVT (172 CV) 11>

HONDA: Accord 2.2 16V / VTEC 92>98, Accord 2.3 16V / EX / EXR 98>, Civic 1.6 16V / EX 98>, Civic 1.6 16V / LX / LXB 97>, Civic DX 94>95, CR-V 2.0 / DOHC (B20B3) 97>99, Odyssey 2.2 16V 96>97, Prelude S / SI SOHC 92>94

MAZDA: 626 2.5 V6 (KLD), 929 V6 (JE-DOHC) 90>, V6 (JE-ZE) 95>, Millenia 2.5 V6 DOHC 95>02, MPV 3.0 V6 (JE EGI) 90>, Xedos 9



GV5R09D-11

Gasoline / GNV - Pack with 04 Spark Plugs | Gasolina / GNV - Paquete con 04 bujías

REPLACES / REEMPLAZA:

BOSCH: FR8HDC+ (two lateral electrodes); **NGK:** BKR5EKB-11

APPLICACION / APLICACIÓN:

TOYOTA: Hilux 3.4 30V V6 / SW4 (5VZ-FE) 97>, Land Cruiser 3.4 30V V6 / SW4 (5VZ-FE) 97>, SW4 V6G 93>95



GV5R10I-13 // NEW //

Gasoline - Pack with 04 Iridium Spark Plugs | Gasolina - Paquete con 04 bujías Iridium

REPLACES / REEMPLAZA:

NGK: ILTR5A-13G

Ford/ Mazda: 1379739, 6M8G-12405-BB, 6118-61240-5BB

APPLICACION / APLICACIÓN:

MAZDA: 3 hatch 2.0 2003>2009, 3 saloon 2.0 2003>2009, 3 - 2.0 MZR / 2.0 MZR DISI 2008>2014, 3 saloon 2.0 MZR / 2.0 MZR DISI 2009>2014, 5 MPV 2.0 2005>2010, 6 hatch/saloon/estate 2.0/2.3 2002>2007, 6 sport 2.0 MZR / 2.5 MZR 2007>2013

SUZUKI: Grand vitara Mk2 3.2 All-wheel Drive 2009>2015



GV5R111-13 // NEW //

Gasoline - Pack with 04 IRIIDIUM Spark Plugs | Gasolina - Paquete con 04 bujías IRIIDIUM

REPLACES / REEMPLAZA:

NGK: ITR5F13, TR5AI13

Ford/ Mazda: L845-18-110, L303-18-110

APPLICATION / APLICACIÓN:

MAZDA: 5 MPV 1.8/2.0 2005>2010, 5 2.0 2010>, 6 sport 2.0 MZR 2010>2012, 6 saloon 2.0 MZR 2010>2012, MX-5 Mk3 1.8 2005>2014



GV5R12P-11 // NEW //

Gasoline - Pack with 04 Spark Plugs | Gasolina - Paquete con 04 bujías

REPLACES / REEMPLAZA:

NGK: PZFR5D-11

Audi/ VW/ Seat/ Skoda: 101905601, 101000062AB

Ford: 1120170, YM21-12405-AA, AGPS44F

APPLICATION / APLICACIÓN:

VOLKSWAGEN: Bora saloon/estate 1.4 16V/2.0/2.3 1999>2005, Caddy Mk2 estate/van 1.4 1995>2004, Fox hatch 1.4 2005>, Golf Mk4 hatch/estate 1.4 16V/2.0/2.3/2.8 1997>2005, Lupo hatch 1.4 2000>2005, New beetle 1.4/2.0/2.3 V5 1998>2010, Passat Mk5 saloon/estate 2.3 V5 2000>2005, Polo classic Mk3 saloon 60 1.4 1995>2001, Polo Mk3 estate 1.4 1997>2001, Sharan 2.8 V6 24V 2000>2010, Transporter T4 minibus/van 2.8 VR6 2000>2003

SKODA: Fabia Mk1 hatch/saloon 1.4 16V 1999>2008, Octavia Mk1 estate 2.0 1999>2010

SEAT: Alhambra MPV 2.8 V6 2000>2010, Arosa hatch 1.0/1.4 1997>2004, Cordoba Mk2 saloon 1.4 16V 2002>2007, Ibiza Mk4 hatch 1.4 16V 2002>2007, Inca van 1.4i 1995>2003, Leon Mk1 hatch 1.6 16V/2.8 Cupra 4 2000>2006, Toledo Mk2 saloon 1.6 16V/2.3 V5 20V 2000>2006

FORD: Galaxy Mk1 2.8 V6 2000>2006



GV5R13P // NEW //

Alcohol / Gasoline - Pack with 04 Spark Plugs | Alcohol / Gasolina - Paquete con 04 bujías

REPLACES / REEMPLAZA:

NGK: TR55GP

Ford: 1S7J12405DA, 1S7J12405EB, 5M5G12405AA, 1128053, 1204572, 1307093

Chevrolet: 32017029, 32017028

APPLICATION / APLICACIÓN:

FORD: Focus Mk2 hatch 2.0 2004>2012, Focus Mk2 saloon 2.0 2005>2011

MAZDA: 3 hatch 2.0 2003>2009, 3 saloon 2.0 2003>2009, Tribute 2.3 AWD 2004>2008

VOLVO: C30 hatch 1.8/2.0 2006>2012, S40 Mk2 saloon 1.8/2.0 2004>2012, V50 estate 1.8/2.0 2004>2012

JAGUAR: S-type 2.5 V6 / 3.0 V6 1999>2007, XJ 3.0 2003>2009, X-Type saloon/estate 2.1 V6 / 2.5 V6 / 3.0 V6 2001>2009

ASTON MARTIN: DB7 vantage/volante 6.0 1999>2003, Vanquish 6.0 V12 2001>2007



GV5R14I-11 // NEW //

Pack with 04 Spark Plugs | Paquete con 04 bujías

REPLACES / REEMPLAZA:

NGK: BKR5EIX-11; Magneti Marelli: 062120030312; Denso: IK16, IK16TT

APPLICATION / APLICACIÓN:

OPEL: MONTEREY B 1998>1999



GV5R15I // NEW //

Pack with 04 Spark Plugs | Paquete con 04 bujías

REPLACES / REEMPLAZA:

NGK: BPR5EIX; Denso: IW16, IW16TT

APPLICATION / APLICACIÓN:

PORSCHE: 928 4.5 1977>1982



GV6P08

Gasoline / GNV - Pack with 04 Spark Plugs | Gasolina / GNV - Paquete con 04 bujías

REPLACES / REEMPLAZA:

BOSCH: WR8D+, Sp4, F000 KE0 P04; **NGK:** B6S

APPLICATION / APLICACIÓN:

FORD: Jeep / Rural (Willys) 184 6 Cil., Maverick 184 6Cil.

GM: C-10 / C-14 / C-15 6 Cil. 261



GV6P09

Gasoline / GNV - Pack with 04 Spark Plugs | Gasolina / GNV - Paquete con 04 bujías

REPLACES / REEMPLAZA:

Bosch: H7DC, HR7D+, Sp8, F000 KE0 P08; **NGK:** BP6EFS

APPLICATION / APLICACIÓN:

FORD: Jeep / Rural (Willys) 2.3 L4 OHC, Maverick 2.3 L4 OHC

GM: Space Van 2.2 8V 97>98, Trafic 2.2 8V

MERCEDES BENZ: 190 E 2.3, 2.6 (M103.942) 09/86>05/93, 230 E 2.3 (M102.982) 04/80>09/92, 260 E 2.6 (160 CV - M103.940 / M103.943) 09/85>09/92, 300 E 3.0 / CE SE, 300 SE/SEL 3.0 (179 CV - M103.981) 09/85>06/91, 300 SL 3.0 (M103.982 / M103.984) 09/85>06/93, 300 TE 3.0

RENAULT: R21 2.2 8V (J6T / J7T), 2.0 / GTX (JR6 / JR7 - 746/747) 03/86>95, Safrane 2.0 (105 CV - J7R 732/733) 06/92>09/96, Safrane 2.2 (J7T-762) 06/92>09/96, Trafic 2.2



GV6P10 // NEW //

Pack with 04 Spark Plugs | Paquete con 04 bujías

REPLACES / REEMPLAZA:

NGK: BP6HS, BP7HS; **Bosch:** W8BC

APPLICATION / APLICACIÓN:

ALPINE: 1300 1.3 1974>1975, A110 1100 (L) 1968>1970;

CITROËN: CX I (MA) 25 Tri 1983>1985, CX I Break (MA) 25 TRI 1983>1985, DS 19 1959>1966, DS 19 1966>1972, DS Conversivel 19 1956>1965, ID 19 B 1964>1975, ID 19 B 1971>1975, ID 19 F 1965>1972, ID 19 F Super 1966>1972, ID 19 P 1959>1964, ID 19 P 1964>1969, ID 20 1969>1975, ID 20 1971>1975, ID Break 19 F 1966>1972, ID Break 20 F 1969>1972, ID Break 20 F 1971>1975;

DACIA: 1300 1.3 1972>1983, 1300 SW 1.3 1972>1983, 1310 SW 1.3 1983>2004, 1310 Sedan (U, X) 1.3 1983>2004;

DAF: 55 1.1 1967>1972, 55 1.1 Marathon 1971>1972, 55 Coupé 1.1 1968>1972, 55 Coupé 1.1 Marathon 1971>1972, 55 Sw 1.1 1968>1972, 66 1.1 1972>1975, 66 1.1 SI 1972>1975, 66 1300 Marathon 1973>1975, 66 Coupé 1300 Marathon 1973>1975, 66 Sw 1.1 1972>1975, 66 Sw 1.1 Marathon 1972>1975, 66 Sw 1300 Marathon 1973>1975;

FIAT: 500 0.5 (110F) 1965>1975, 500 0.6 1968>1976;

FORD: Taunus 12M (11G) 1.2 1966>1971, Transit '55- Furgão 1250 S-2 Klein-Lkw 1957>1967, Transit '55- Van Passanger K-40 1.5 1955>1967, Transit Caminhão De Plataforma/Chassis (74E) 1.5 1971>1973, Transit Furgão (81E) 1.7 1300 (81E4Sa) 1967>1973, Transit Furgão (81E) 1.7 1300 Feuerw. (810000) 1965>1973, Transit Van Passanger (72E, 73E) 1.5 1000 (72E2A) 1968>1973, Transit Van Passanger (72E, 73E) 1.5 1100 (72000) 1965>1971, Transit Van Passanger (72E, 73E) 1.5 900 (7200) 1965>1969, Transit Van Passanger (72E, 73E) 1.5 900 (7300) 1965>1973, Transit Van Passanger (72E, 73E) 1.7 (72E3C) 1971>1973, Transit Van Passanger (72E, 73E) 1.7 1000 (72E2A) 1971>1973, Transit Van Passanger (72E, 73E) 1.7 1300 (820000) 1966>1973, Transit Van Passanger (72E, 73E) 1.7 900 (7300) 1971>1971;

MERCEDES BENZ: Ponton (W180) 220 (180.010) 1954>1956, Ponton (W180) 220 S (180.010) 1956>1959 MG: MGB GT 3.5 (D1) 1972>1977 OPEL: Admiral B 2.8 S 1969>1975, Olympia A 1.0 1967>1971, Olympia A 1.7 1967>1971, Olympia A Coupé 1.0 1967>1971, Olympia A Coupé 1.7 1967>1971, Olympia A Coupé 1.9 1967>1971, Rekord B 1.5 1965>1966, Rekord B 1.7 1965>1966, Rekord B 1.9 1965>1966, Rekord B Coupé 1.7 1965>1966, Rekord B Coupé 1.9 1965>1967, Rekord B Sw 1.5 1965>1966, Rekord B Sw 1.7 1965>1966;

PORSCHE: 356 Cabriolet/Speedster A 1600 GS Carrera 1955>1959;

RENAULT: 12 1.3 (1170) 1975>1980, 12 1.3 (1170) 1969>1980, 12 1.3 TS (1177, 1337) 1972>1980, 12 Variable (117_) 1.3 (1170) 1975>1980, 12 Variable (117_) 1.3 (1170) 1970>1980, 12 Variable (117_) 1.3 (1177) 1973>1980, 15 (130_) 1.3 (1300) 1972>1980, 4 (112_) 0.8 (1123) 1962>1983, 4 (112_) 0.8 (1123) 1983>1988, 4 (112_) 0.8 (1123) 1971>1988, 4 (112_) 1.1 (1128, S128) 1978>1990, 4 Caixa/Minivan (R21_, R23_) 0.8 (2106) 1966>1988, 4 Caixa/Minivan (R21_, R23_) 0.8 (2391) 1983>1989, 4 Caixa/Minivan (R21_, R23_) 1.1 (2370, 210B) 1976>1989, 4 Caixa/Minivan (R21_, R23_) 1.1 (239B) 1982>1989, 5 (122_) 0.8 (1221, 1391) 1982>1984, 5 (122_) 0.8 (1221, 1391, 1220) 1972>1984, 5 (122_) 1.0 (1222, 1392) 1972>1985, 5 (122_) 1.1 (1227, 1397) 1980>1985, 5 (122_) 1.3 (1224, 1394) 1975>1984, 5 (122_) 1.3 (1225) 1976>1979, 5 (122_) 1.3 Automatik (1225, 1395) 1979>1984, 6 (118_) 0.8 1969>1980, 6 (118_) 1.1 1970>1987, 6 (118_) 1.1 1971>1980, RODEO 4 (ACL_) 0.8 1971>1981, RODEO 5 (4D_, 5E_) 1.1 1981>1987, RODEO 6 (ACL_) 0.8 1970>1973, RODEO 6 (ACL_) 1.1 1973>1981 ROVER: 2000-3500 (P6) 3500 1968>1976, 2000-3500 (P6) 3500 1968>1976 SKODA: 105,120 (742) 1.0 105 S,L 1976>1990, 105,120 (742) 1.0 105 S,L,GI 1976>1983, 105,120 (742) 1.2 120 L 1976>1990, 105,120 (742) 1.2 120 Ls 1976>1990, 105,120 (744) 1.0 105 S,L 1988>1990, 105,120 (744) 1.0 105 S,L,LS 1983>1990, 105,120 (744) 1.2 120 Gls 1983>1990, 105,120 (744) 1.2 120 L 1987>1990, 105,120 (744) 1.2 120 L 1983>1990, 130 G,GI (S136) 1985>1991, 130 GI 1987>1991, 130 GI (S135) 1987>1991, 130 L,GI 1985>1991, Rapid (120G, 130G, 135G) 1.3 (130G) 1985>1988, Rapid (120G, 130G, 135G) 1.3 S (135GI) 1984>1990;

TRABANT: P 601 0.6 1966>1970, P 601 0.6 1970>1990, P 601 Furgão 0.6 1966>1990, P 601 Tramp 0.6 1966>1990, P 601 Universal 0.6 1966>1990;

TRIUMPH: TR 4 2.0 1961>1965;

VOLVO: 140 (142, 144) 2.0 1968>1974, 140 (142, 144) 2.0 1971>1972, 140 (142, 144) 2.0 S 1968>1972, 140 (142, 144) 2.0 S 1972>1975, 140 Sw (145) 2.0 S 1968>1974, 140 Sw (145) 2.0 S 1972>1973, 140 Sw (145) 2.0 S 1972>1974, 140 Sw (145) 2.0 S 1973>1975, 164 (164) 2.9 E 1968>1973, 240 (P242, P244) 2.0 1974>1976, 240 Kombi (P245) 2.0 1974>1975, 66 (31, 36) DI 1.1 1975>1978, 66 (31, 36) GI 1.3 1975>1978, 66 Sw (64) DI 1.1 1975>1979, 66 Sw (64) GI 1.3 1975>1979, P 121 2.0 1968>1971, P 122 S Amazon 1.8 1959>1967, P 122 S Amazon 1.8 1966>1971, P 122 S Amazon 2.0 1968>1971



GV6P83

Alcohol - Pack with 04 Spark Plugs | Alcohol - Paquete con 04 bujías

REPLACES / REEMPLAZA:

AC Delco: 43XLS; **Bosch:** W7DC, Sp 13, F000 KE0 P13; **Champion:** N9YC; **Denso:** W20EP-U; **NGK:** BP6ES

APPLICATION / APLICACIÓN:

VW: Apollo 1.8 carb. (AP) - Coil with Pin 06/90>11/92, Belina, Corcel, Del Rey, Escort, Pampa, Royale, Versailles, Verona 1.8 (AP) >91, Fusca 1.3/1.6 "Long Thread" 84>10/86, Gol 1.3/1.6 (Air cooled) "Long Thread" All, Gol 1.6/1.8/2.0 (AP) >91, Kombi 1.6 (without catalyst) "Long Thread" >91, Parati, Voyage 1.6/1.8/2.0 (AP) 82>91, Passat 1.5/1.6/1.8 (AP) 74>86, Passat 1.6/1.8/2.0 (AP) 87>, Quantum, Santana 1.6/1.8/2.0 (AP) >91, Saveiro 1.3/1.6 (Air cooled) "Long Thread" All, Saveiro 1.6/1.8/2.0 (AP) >91;



GV6P84

Gasoline - Pack with 04 Spark Plugs | Gasolina - Paquete con 04 bujías

REPLACES / REEMPLAZA:

AC Delco: 42TS; **Bosch:** H6BC, Sp 15, F000 KE0 P15; **Champion:** S9YC; **Denso:** T20P-I; **NGK:** BP6FS

APPLICATION / APLICACIÓN:

GM: Chevette 1.0/1.4/1.6 - All, Chevy, Marajó 1.4/1.6 - All;



GV6R01

GNV / Bicomcombustível (Brazil) - Pack with 04 Spark Plugs | GNV / Bicomcombustível (Brasil) - Paquete con 04 bujías

REPLACES / REEMPLAZA:

Bosch: F6HER2+, Sp29, F000 KE0 P29; **NGK:** ZFR6P-G, ZFR6P-DG

APPLICATION / APLICACIÓN:

VW: Cross Fox 1.6 8V / Totalflex (101CV Gasoline / 103CV alc. - EA 111 - RSH) 05>04/08, Fox 1.0 8V / Totalflex (72CV - EA 111 RSH) 09/03>10/04, Fox 1.6 8V / Totalflex EA 111 RSH 03>04/08, Golf 1.6 / TotalFlex (101CV Gasoline/ 103CV alc. - BPA) 06>04/08, Polo 1.6 8V / Totalflex (101 CV Gasoline./103 CV alc.) 11/04>04/08, Polo Sedan 1.6 8V / Totalflex (101 CV Gasoline./103 CV alc. - BPA) 11/04>04/08, Space Fox 1.6 8V / TotalFlex(101 CV Gasoline./103 CV alc.-BPA) 06>04/08



GV6R02

Alcohol / Gasoline / Bicomcombustível (Brazil) - Pack with 04 Spark Plugs | Alcohol / Gasolina / Bicomcombustível (Brasil) - Paquete con 04 bujías

REPLACES / REEMPLAZA:

AC Delco: CR43CXLS; **Bosch:** WR7DC; **Champion:** RN9YC; **Denso:** W20EXR-U; **NGK:** BPR6EY

APPLICATION / APLICACIÓN:

FIAT: Doblò, Doblò Adventure, Idea Adventure 1.8 8V (112 CV Gasoline./114 CV. Alc.) (bicomcombustível) 06>, Doblò Adventure 1.8 8V (Gasoline) 04>06, Palio Adventure 1.8 8V (112 CV Gasoline./114 Cv Alc.) (Gasoline/bicomcombustível) 05>, Palio Weekend 1.8 8V (Gasoline) 03>, Palio Weekend 1.8 8V (bicomcombustível) 04>, Punto 1.8 8V (MPFI)(113 CV Gasoline./115 CV Alc.) (Gasoline/bicomcombustível) 07>, Tempra 2.0 16V with/ without Distribuidor (Gasoline) - All;

FORD: Belina, Corcel, Del Rey 1.8 (AP - Alcohol) >91, Escort 1.6/1.8 (AP - Alcohol) 93>94, Escort 1.6/1.8 Inj. (AP - Alcohol) 95>, Escort 2.0 EFI (AP - Alcohol) 95>, Escort XR3 (Alcohol) 92>94, Pampa 1.6/1.8 (AP) (Alcohol) 93>96, Royale, Versailles 1.8/2.0 (AP-Alcohol) - All, Verona 1.6/1.8 (AP-Alcohol) 93>94, Verona 2.0 EFI (AP - Alcohol) 95>;

GM: Astra 2.0 8V (Flexpower) 04>, Blazer 2.4 (MPFI - Gasoline) 01>, Caravan, Comodoro 4/6 Cil. (ign. conv. electr.) (Alcohol) - All, Celta 1.0 8V/SOHC 60CV (MPFI - Gasoline) 00>, Celta 1.4 8V/SOHC (MPFI - Gasoline) 07/03>, Corsa 1.0/1.4/1.6 8V (EFI/MPFI - Gasoline) - All, Corsa 1.8 8V SOHC (MPFI - Gasoline) 02>, Meriva, Montana 1.8 8V (Flexpower) 03>, Meriva 1.8 8V SOHC (MPFI - Gasoline) 02>, Omega, Suprema 4.1 L6 (MPFI - Gasoline) - All, S10 2.4 (Coil behind the motor) (MPFI - Gasoline) 01>, Silverado 4.1 L6 (Gasoline) - All, Vectra 2.0 8V (Flexpower - 121 CV Gasoline./128 CV Alc.) 05>, Zafira 2.0 8V (Flexpower - 121 CV./128 CV Alc.) 04>;

VW: Apollo 1.8 Carb. Coil with Pin (AP - Gasoline) 06/90>11/92, Fusca 1.3/1.6 "Long Thread" (Alcohol) 84>10/86, Gol 1.3/1.6 (Air cooled) "Long Thread" (Alcohol) - All, Gol 1.6/1.8 (AP - Alcohol) >91, Kombi 1.6 (without catalyst) "Long Thread" (Alcohol) >91, Logus 1.6/1.8/2.0 (AP - Alcohol) 93>94, Parati 1.6/1.8 (AP - Alcohol) 82>95, Passat 1.5/1.6/1.8 (AP - Alcohol) 74>86, Passat 1.6/1.8/2.0 (AP - Alcohol) 87>, Quantum, Santana 1.6/1.8/2.0 (AP - Alcohol) >91, Saveiro 1.3/1.6 (Air cooled) "Long Thread" (Alcohol) - All, Voyage 1.6/1.8 (AP - Alcohol) 82>95;



GV6R03-10

Gasoline / GNV / Bicomcombustível (Brazil) - Pack with 04 Spark Plugs | Gasolina / GNV / Bicomcombustível (Brasil) - Paquete con 04 bujías

REPLACES / REEMPLAZA:

NGK: BKR6ESZ-10

APPLICATION / APLICACIÓN:

NISSAN: Livina 1.6 16V / Flex (108 CV alc./ 104 CV Gasoline.- K4M) 09>

RENAULT: Clio 1.6 16V (K4M) 04>, Clio 1.6 16V / Hi-Flex (K4M) 05>, Clio Sedan 1.6 16V / Hi-Flex (110 CV Gasoline. / 115 CV alc. - K4M) 05>, Duster 1.6 16V (110CV Gasoline. / 115CV alc. - K4M) - 2.0 16V (138CV Gasoline. / 143CV alc. - F4R) 11>, Grand Scenic 2.0 16V (138 CV - F4R) 08>, Kangoo 1.6 16V (K4M) 04>, Kangoo 1.6 16V / Hi-Flex (110 CV Gasoline. / 115 CV alc. - K4M) 06>, Logan 1.6 16V / Hi-Flex (107 CV Gasoline. / 112 CV alc. - K4M) 07>, Megane 1.6 16V (K4M) 04>, Megane CC 2.0 16V / CC (138 CV - F4R) 08>, Megane Grand Tour 1.6 16V / Hi-Flex (110 CV Gasoline. / 115 CV alc. - K4M) 07>, Megane Grand Tour 2.0 16V (138 CV - F4R) 07>, Megane Sedan 1.6 16V / Hi-Flex (110 CV Gasoline. / 115 CV alc. - K4M) 06>, Megane / Sedan 2.0 16V (138 CV - F4R) 05>, Sandero 1.6 16V / Hi-Flex(107 CV Gasoline./112 CV alc.-K4M) 08>, Scenic 1.6 16V (K4M) 04>, Scenic 1.6 16V/ Hi-Flex(110 CV Gasoline./115 CV alc.-K4M) 05>, Symbol 1.6 16V / Hi - Flex (115 alc. / 110 Gasoline. - K4M) 09>



GV6R04I-11

Gasoline / GNV / Bicomcombustível (Brazil) - Pack with 04 Spark Plugs | Gasolina / GNV / Bicomcombustível (Brasil) - Paquete con 04 bujías

REPLACES / REEMPLAZA:

NGK: IZFR6K11DS

APPLICATION / APLICACIÓN:

HONDA: Accord 2.0 16V / LX (156 CV - SOHC i-VTEC) 08>, Civic 1.8 16V i-VTEC / LX / LXS / EXS (140 CV) 06>, Civic 1.8 16V i-VTEC FLEX / LXS / EXS (138 CV Gasoline. / 140 CV alc.) 06>



GV6R05-10

Alcohol / Gasoline / GNV / Bicombustível (Brazil) - Pack with 04 Spark Plugs.

REPLACES / REEMPLAZA:

Bosch: HR7M+U, Sp10, F000 KE0 P10; **NGK:** TR6B-1

APPLICATION / APLICACIÓN:

FORD: Courier 1.6 / Zetec Rocam 09/99>, Courier 1.6 / Zetec Rocam Flex (96 CV Gasoline-107 CV alc) 07>10/08, Courier 1.6 8V / Zetec Rocam Flex (103 CV Gasoline / 109 CV alc.) 11/08>, Ecosport 1.6 8V / Zetec Rocam (W37) 03>, Ecosport 1.6 8V / Zetec Rocam Flex (105 CV Gasoline / 111 CV alc. - WFF) 05>10/08, Ecosport 1.6 8V / Zetec Rocam Flex (101 CV Gasoline / 107 CV alc.) 11/08>, Escort 1.6 / Zetec Rocam 99>, Escort 1.6 / Zetec Rocam 11/00>10/02, Fiesta 1.0 8V / Zetec Rocam 99>07/06, Fiesta 1.6 8V / Zetec Rocam (W37) 99>, Fiesta 1.6 8V / Zetec Rocam Flex (WFF) 04>10/08, Fiesta 1.6 8V / Zetec Rocam Flex (101 CV Gasoline / 106,6 CV alc. - WFF) 11/08>, Focus 1.6 8V - SOHC / Zetec Rocam (103 CV), Focus 1.6 8V / Zetec Rocam Flex (105,2 CV Gasoline - 112,6 CV alc) 03/07>, Ka 1.0 / Zetec Rocam 99>, Ka 1.6 / Zetec Rocam 99>, Ka 1.6 8V / Zetec Rocam Flex (102 CV Gasoline / 110 CV alc.) 08>



GV6R06

Alcohol - Pack with 04 Spark Plugs | Alcohol - Paquete con 04 bujías

REPLACES / REEMPLAZA:

AC Delco: FR2LS; **Bosch:** Sp, F000 KE0 P0; **Champion:** RC9YC; **Denso:** Q20R-U; **NGK:** BCP6ES

APPLICATION / APLICACIÓN:

FORD: Escort (CHT) - All;

PEUGEOT: 306 1.8i / XT (XU7JP) - All;

VW: Gol - All;



GV6R07-13

Gasoline / GNV - Pack with 04 Spark Plugs | Gasolina / GNV - Paquete con 04 bujías

REPLACES / REEMPLAZA:

Bosch: HR8MVC+, 0 242 229 785; **NGK:** TR6B-13

APPLICATION / APLICACIÓN:

FORD: Courier 1.4 16V / Zetec 07/97>08/99, Escort 1.8 16V / Zetec, Fiesta 1.4 16V / Zetec, Focus 1.8 / 2.0 16V / Zetec (115 / 130 CV), Mondeo 1.8 / 2.0 16V / (Zetec) GLX / CLX; **RENAULT:** R21 2.2 8V (J6T / J7T), 2.0 / GTX (JR6 / JR7 - 746/747) 03/86>95, Safrane 2.0 (105 CV - J7R 732/733) 06/92>09/96, Safrane 2.2 (J7T-762) 06/92>09/96, Trafic 2.2



GV6R10I-13

GNV / Bicombustível (Brazil) - Pack with 04 IRIDIUM Spark Plugs | GNV / Bicombustível (Brasil) - Paquete con 04 bujías IRIDIUM

REPLACES / REEMPLAZA:

NGK: IZFR6K13DN

APPLICATION / APLICACIÓN:

HONDA: City 1.5 16V / SOHC i-VTEC Flex (116 alc. / 115 Gasoline.) 09>, Fit 1.4 16V / i-VTEC Flex (101 CV alc. / 100 CV Gasoline.) 09>



GV6R11T-10

Gasoline / GNV - Pack with 04 Spark Plugs | Gasolina / GNV - Paquete con 04 bujías

REPLACES / REEMPLAZA:

BOSCH: FR7LT+, Sp6, F000 KE0 P06 (3 ELETRODOS LATERAIS); **NGK:** BKUR6ET-10

APPLICATION / APLICACIÓN:

AUDI: 80 2.6 (ABC / ACZ) - 2.6 / Avant (ABC / ACZ) 04/92>, 80 2.8 V6 / Cabriolet E (AHH) 08/91>, 100 2.8 V6 - 2.8 V6 / Avant 12/90>, A3 1.6 8V (AEH) 96>99, A3 1.6 8V (APF / AKL / ME-8 / M-63) 99>01, A3 1.8 - with 3 electrodos (AGN / MQ8 / M51) 05/99 a 08/00, A4 1.8 20V, A3 2.6 (ACZ / ABC) - 2.8 (AAH / AFC) 06/94, A4 Avant 1.8 20V, A6 2.6 (ACZ / ABC) 04/94, A6 2.8 (AAH / AFC) 06/94>, A6 Avant 2.6 30V V6 / Quattro (ABC / ACZ) 06/94>

MERCEDES BENZ: C230 K 2.3 / Kompressor (192 CV - M 111.975) 10/95>, Classe A160 1.6, SLK230 2.3 16V / Kompressor (193 CV - M111.973) 09/96>02/00

SEAT: Cordoba 1.6 8V (100 hp - AKL) 10/99>03, Ibiza 1.6 8V (100 hp - AKL) 10/99>03, Vario 1.6 8V (100 hp - AKL) 10/99>03

VW: Bora 2.0 8V (116 CV - CBPA) 06/07>, Bora 2.0 8V (APK / BHP / BER) 00>05/07, Gol 1.0 16V / without distributor (RSH) 08/01>, Golf 1.6 8V - Alemão / A4 (EA111) 08/98>07/99, Golf 1.6 8V (AKL) - tucho hidráulico / A4 (EA 113 - cárter em alumínio) 08/98>, Golf 2.0 8V (APK / AEG / AKL / BER / BHP / CBPA) 08/99>, New Beetle 2.0 8V (116 CV) 11/99>06/05, Golf 2.0 8V (116 CV - BER / BHP / CBPA) 07/05>, Parati 1.0 16V / without distributor (RSH) 08/01>, Passat / Variant 1.8 (ADR / APT / AFY) 04/98>02/01, Passat / Variant 2.0 - sextavado 16mm (AZM) 03/01>, Polo 1.0 16V (RSH) - 2.0 8V (116 CV - BBX) 05/02>07/06, Polo Sedan 2.0 8V (116 CV - BBX) 11/02>



GV6R12P

Gasoline / GNV - Pack with 04 Spark Plugs | Gasolina / GNV - Paquete con 04 bujías

REPLACES / REEMPLAZA:

BOSCH: FR7DPP33, 0 242 235 740 (PLATINUM); **NGK:** PFR6Q

APPLICATION / APLICACIÓN:

AUDI: A3 1.8 20V - turbo - com 1 electrodo (180 CV - AJQ / APP / ARZ / AQA / AUQ) 99>, A3 1.8 20V (125 CV - APG) 99>, A3 2.0 16V Turbo / TFSI (200 CV - AXX / BWA) 09/04>, A4 1.8 - turbo (AJL) 02/98>, A4 Avant 1.8 20V - turbo (APU / ARQ / ANB) 08/98>, A4 Avant 2.0 (BGB / BUL) 11/04>, A6 Avant 2.7 30V V6 / Quattro 07/98>, Allroad 2.7 V6 Turbo / QUATTRO (APB/BEL) 01>04, Roadster 1.8 20V (AJQ / APX) 07/98>, Roadster 1.8 20V (APP) 07/99>, S3 1.8 20V - turbo 11/98>, S4 Avant 2.7 V6 / Quattro - turbo 07/98>, TT 1.8 20V / Quattro turbo, TT Coupe / Roadster 2.0 16V Turbo / TFSI - DOHC (200 CV - BWA) 08/06>, LOBINI H1 1.8 20V / Turbo (180 CV - AUQ)

VW: Golf 1.8 20v turbo (AWD / AWW / AUQ / BEK / AWP) 03/00>, Golf 1.8 20V Turbo / GTI (182 CV - AUQ) 03/07>, New Beetle 1.8 (APH / AWW / AWW) 99>, Passat / Variant 1.8 turbo (APU) 99>02/01, Passat / Variant 1.8 20V / Turbo (152 CV - AWT) 03/01>09/05, Polo 1.8 Turbo / GTI (150 CV - BJX) 06/06>



GV6R13-11

Gasoline / GNV / Bicombustível (Brazil) - Pack with 04 Spark Plugs | Gasolina / GNV / Bicombustível (Brasil) - Paquete con 04 bujías

REPLACES / REEMPLAZA:

BOSCH: FR6DCX+, Sp46, F000 KE0 P46; **NGK:** BKR6E-11, BKR6E-11D

APPLICATION / APLICACIÓN:

CHRYSLER (DODGE / JEEP): Cirrus 2.4 16V (8° dig. chassi - G) 94>96

DAEWOO: Lanos 1.6 16V - DOHC 97>

DAIHATSU: Applause 1.6 - SOHC 94>97, Charade 1.3 (90 CV - HC-E) 95>, Charade 1.5 - SOHC / 1.6 - SOHC 94>97, Feroza 1.6 - SOHC 94>97, Gran Move 1.5 / 1.6 - SOHC 97>

FORD: Probe 2.0 16V / DOHC -AT/MT (115 CV) 93>97

GM: Tracker 2.0 16V (128 CV) 07>

HONDA: Fit 1.4i / DSI - Twin Spark 03>, Fit 1.4 i-DSI Twin Spark Flex / LX / LXL (80 CV Gasolina. / 83 CV alc.) 06>, Legend 3.2 24V V6 96, Fit 3.5 24V V6 96>97

ISUZU: Rodeo 3.2 V6 93>95

KIA MOTORS: Clarus 2.0 16V / GLX (FE DOHC) 97>00, Sephia 1.5 16V / GTX 92>10/94, Shuma 1.5 16V (BFD) 98>00, Sportage 2.0 16V 94>

MAZDA: MX-5 1.6 16V (B6)

MITSUBISHI: Colt 1.6 (4G92) 92>, Colt 1.6 / 1.8 / GLXi / GTI, Colt 1.8 (4G93) 95>96, Galant 2.0 mpi (4G63) 93>96, Galant 2.0 (6A12) 94>96, Lancer 1.6 / 1.8 / GLXi / GTI, Lancer 1.8 mpi (4G93) 94>96, Pajero TR4 2.0 16V / Flex (131 CV Gasolina. / 133 CV alc. - 4G94) 07>06/09, Space Wagon 2.0 L4 / mpi catalis. (127 CV - 4G63) 93>96

SUBARU: Forester 2.0 16V 98>03, Impreza 1.6 16V - mfi / 1.8 16v - mfi / 2.0 16v - mfi 93>00, Legacy 1.8 8V / 2.2 16V - mfi 93>99, Legacy 2.0 16v - mfi 93>94, Legacy 2.5 - DOHC 01>, Vivio 0.7 - mfi 93>98

SUZUKI: Baleno 1.8 - DOHC (J18A), Grand Vitara 1.6 16V (G16B) / 2.5 24V V6 (H25A) 98>00, Grand Vitara 1.6 / 2.0 / 2.5 98, Grand Vitara 2.0 16V (J20A) 98>07, Grand Vitara 2.0 16V / DOHC (140 CV - J20A) 11/08>, Ignis 1.3 16V (M13A) 10/00>, Jimny 1.3 (82 CV - G13) 01>, SX4 2.0 16V (145CV) 08>

TOYOTA: Camry 3.0 V6 (1MZ-FE) 91>93



GV6R14-11

Gasoline / GNV - Pack with 04 Spark Plugs | Gasolina / GNV - Paquete con 04 bujías

REPLACES / REEMPLAZA:

BOSCH: FR7LCX; **NGK:** ZFR6K-11

APPLICATION / APLICACIÓN:

HONDA: Accord 2.0 16V DOHC / i-VTEC LX (150 CV) 05>, Accord 2.4 16V / VTEC 04>, Accord 3.0 V6 24V VTEC / EX (240 CV) 04>07, CR-V 2.0 16V DOHC (150 CV) 02>06, CR-V 2.4 / DOHC - VTEC 02>



GV6R15

Gasoline / GNV / Bicombustível (Brazil) - Pack with 04 Spark Plugs | Gasolina / GNV / Bicombustível (Brasil) - Paquete con 04 bujías

REPLACES / REEMPLAZA:

BOSCH: FR7D+; **NGK:** BKR6ES

APPLICATION / APLICACIÓN:

CITROËN: C3 1.4 8V / Flex (82 CV alc. - 80 CV Gasolina. - TU3JP) 06>

PEUGEOT: 206 1.4 8V / Flex (82 CV alc - 80 CV Gasolina - TU3JP) 06>, 206 SW1.4 8V / Flex (80 CV Gasolina. / 82 CV alc - TU3JP) 06>, 207 1.4 8V / Flex (80 CV Gasolina. - 82 CV alc. - TU3JP) 08>, 207 SW 1.4 8V / Flex (80 CV Gasolina. - 82 CV alc. - TU3JP) 08>, 306 2.0 16v / S16 (XU10J4) >03/97, Hoggar 1.4 8V (82 CV alc / 80 CV Gasolina. - TU3JP) 10>

RENAULT: Scenic 2.0 16V (F4R) 07/00>

VOLVO: 960 3.0 L6 (B6304S / F) 92>97, S70 2.5 20V (B5254S) 97>, V70 2.5 10V (144 CV - B5252S) 01/97>03/00, V70 2.5 20V (170 CV - B5254S) 97>03/00



GV6R20

Pack with 04 Spark Plugs | Paquete con 04 bujías

REPLACES / REEMPLAZA:

NGK: DCPR6E

BOSCH: X5DC

DENSO: X27EPRU9

BMW: 12129062217, 12129061882, 12121460800, 12121460799, 12121312569

CHAMPION: 810RA8HC

APPLICATION / APLICACIÓN:

BMW: Series 6 Coupe: M635 Csi 1984>1989



GV6R21-07 // NEW //

Gasoline - Pack with 04 IRIIDIUM Spark Plugs | Gasolina - Paquete con 04 bujías IRIIDIUM

REPLACES / REEMPLAZA:

NGK: IFR6Z7G, IFR6AD7DG

Chevrolet: 55585534

Opel: 55580961

APPLICATION / APLICACIÓN:

OPEL: Zafira B MPV 1.6 CNG Turbo 2009>2015, Zafira B van 1.6 CNG Turbo 2009>2015, Zafira tourer C 1.6 CNG 2011>



GV6R22I-11 // NEW //

Gasoline - Pack with 04 IRIIDIUM Spark Plugs | Gasolina - Paquete con 04 bujías IRIIDIUM

REPLACES / REEMPLAZA:

NGK: IZFR6H11

BMW: 12120032134, 12122158252, 12127526799

APPLICATION / APLICACIÓN:

BMW: Series 1 : 118i/120i 2003>2011 / Series 3: 316i / 318i 2001>2005, 316ti / 318ti 2001>2005, 316Ci / 318Ci 2002>2006, 318Ci 2005>2007 / Series 5: 540i / 550i 2005>2010, 650i 2005>2010 / Series 7: 740i / 750i 2005>2008, X3 2.0i 2005>2008, X5 4.8is 2004>2006, X5 4.8i xDrive 2007>2008, Z4 roadster 2.0i 2005>2009



GV6R23P-11 // NEW //

Gasoline - Pack with 04 Spark Plugs | Gasolina - Paquete con 04 bujías

REPLACES / REEMPLAZA:

NGK: PLZKAR6A-11

Nissan: 22401-CK81, 22401-CK81B, 22401-CK87B, 22401-CK87B-VA, 22401EA015

Renault: 22401EA015, 7701065085

APPLICATION / APLICACIÓN:

NISSAN: Micra Mk3 160 SR 2005>2010, Micra C+C convertible 1.6 160 SR 2005>, Note 1.6 2006>2012, Qashqai 1.6/2.0 2007>2013, Tiida saloon 1.6 2007>2012, Tiida hatchback 1.6 2007>2011, X-Trail 2.0 2007>2013, Evalia bus 1.6 16V 2010>, NV200 box body / estate 1.6 16V 2010>

RENAULT: Clio Mk3 hatch 2.0 16V 2006>, Fluence 2.0 16V 2010>, Laguna Mk3 hatch/estate 2.0 16V 2007>2015, Megane III hatchback 2.0 CVT 2009>, Megane III grandtour 2.0 CVT 2009>, Megane III coupe 2.0 CVT 2009>, Megane CC 2.0 CVT 2010>, Scenic III 2.0 16V 2009>, Grand Scenic III 2.0 16V 2009>



GV6R24P-13 // NEW //

Alcohol / Gasoline - Pack with 04 Spark Plugs | Alcohol / Gasolina - Paquete con 04 bujías

REPLACES / REEMPLAZA:

NGK: TR6AP-13

Ford: 5M5G-18344-AA, 5M5G-12405-AA, 1369704

Volvo: 30777349, 30731878

APPLICATION / APLICACIÓN:

FORD: C-Max 1.8/2.0 2007>2010, Focus C-Max 1.8/2.0 2004>2007, Focus Mk2 hatch/saloon/estate 1.8/2.0 2004>2012, Galaxy Mk2 2.0 2006>2015, Mondeo Mk4 hatch/saloon/estate 2.0 2007>2015, S-Max 2.0 2006>2014

VOLVO: C30 hatch 1.8/2.0 2006>2012, S40 Mk2 saloon 1.8/2.0 2004>2012, S80 Mk2 saloon 2.0 2008>2012, V50 estate 1.8/2.0 2004>2012, V70 Mk3 estate 2.0 2007>2011



GV6R25-10 // NEW //

Gasoline / GNV - Pack with 04 Spark Plugs | Gasolina / GNV - Paquete con 04 bujías

REPLACES / REEMPLAZA:

NGK: LZKR6B-10E

Bosch: 0 242 129 515

Kia/ Hyundai: 18854-10080, 18855-10060

APPLICATION / APLICACIÓN:

KIA: Rio III 1.4 CVVT 2011>, Carens Mk3 1.6 CVVT 2009>, Ceed1d hatch/estate 1.4/1.6 2006>2012, Pro Ceed hatch 1.4/1.6 2008>2012, Soul 1.6 CVVT 2009>, Venga 1.4/1.6 CVVT 2010>

HYUNDAI: i20 1.4 2008>2015, ix20 1.4/1.6 2010>, i30 hatch 1.4/1.6 2007>2011, i30 estate 1.4/1.6 2008>2012, i30 2011>2015



GV6R27I // NEW //

Pack with 04 Spark Plugs | Paquete con 04 bujías

REPLACES / REEMPLAZA:

Isuzu: 8-9717-0268-0; Lexus: 90098-66054, 90098-66077, 90098-66114; Mazda: JE41-18-110, JE42-18-110, 0000-18-JE41, 1UD3-18-110, 1UN9-18-110;

Mitsubishi: MZ 602 020, MZ 602 065; Nissan: BY481-BKR5E; Subaru: SAB 330 DE 3360, SAB 330 DE 8680; Suzuki: 99000-79J80-K16;

Toyota: 90098-66054, 90098-66077, 90098-66114; Bosch: 0 242 236 544

APPLICATION / APLICACIÓN:

VOLVO: S70 2.3 T-5 1997>2000



GV6R28I-11 // NEW //

Pack with 04 Spark Plugs | Paquete con 04 bujías

REPLACES / REEMPLAZA:

NGK: SILZKR6B-11; Bosch: 0 242 129 524; Denso: VXUH20I

APPLICATION / APLICACIÓN:

HYUNDAI: Accent Iv Stufenheck: 1.4/ 2010>, Equus / Centennial 3.8/ 2009>, Genesis 3.8 V6/ 2011>2014, Genesis Coupe 3.8 V6/ 2008>2014, I10 1.0/1.2/ 2008>2017, I20 1.2/ 2008>2015, I30 1.4/1.6/1.6 GDI/ 2011>2016, I30 Coupe 1.4/1.6 GDI/ 2013>, Ix35 1.6/ 2010>, I40 1.6 GDI/ 2012>, Tucson 1.6 GDI/ 2015>, Veloster 1.6 GDI/ 2011>2017;

KIA: Carens Iv 1.6 GDI/ 2013>, Ceed 1.4 MPI/1.6 GDI/ 2012>, Ceed Sportswagon 1.4 MPI/1.6 GDI/ 2012>, Pro Ceed 1.4 MPI/1.6 GDI/ 2013>, Opirus 3.8 V6/ 2006>, Optima 2.0 CVVT Hybrid/ 2012>, Picanto 1.0/1.0 LPG/1.0 Bi-Fuel/1.2/ 2011>, Rio Iii 1.2 CVVT/1.25 CVVT/ 2011>, Rio Iii Stufenheck 1.2 CVVT/ 2014>, Rio Iv 1.4/ 2017>, Soul 1.6 GDI/ 2011>, Soul I 1.6 CVVT/1.6 GDI/ 2014>, Sportage 1.6 GDI/ 2011>;

MITSUBISHI: Lancer Viii Sportback 1.8 MIVEC/1.8 Bifuel/ 2009>, Outlander Iii 2.0 (GF7W)/2.0 4WD (GF7W)/ 2012>;

OPEL: Ampera EV 150/ 2011>2015;

SUZUKI: Baleno 1.2 (A1K412)/1.2 Hybrid (A1K412)/ 2016>, Ignis Iii 1.2 (ATK412)/1.2 AllGrip (ATK412)/1.2 Hybrid (ATK412)/1.2, Hybrid AllGrip (ATK412)/ 2016>, Swift Iv 1.2 (AZG 412)/1.2 4x4 (AZG 412)/1.2 (AZH 412)/1.2 4x4 (AZH 412)/ 2010>



GV6R29-11 // NEW //

Pack with 04 Spark Plugs | Paquete con 04 bujías

REPLACES / REEMPLAZA:

NGK: BCPR6EY-N-11; Bosch: 0 242 240 638, SP46, F 000 KE0 P46; Denso: Q20TT, Q20R-U11

APPLICATION / APLICACIÓN:

FORD: Escort Iv Turnier 1.4/ 1986>1990, Escort Iv Turnier 1.4/ 1986>1990, Escort Iv Cabriolet 1.4/1.6 i/ 1987>1990, Escort V 1.6/RS 2000/RS 2000 4x4/ 1990>1995, Escort V Turnier 1.6/ 1990>1992, Escort V Cabriolet 1.6/ 1990>1993, Escort Vi RS 2000/RS 2000 4x4/ 1995>1998, Escort '86 Express 1.4 i/ 1986>1990, Fiesta Ii 1.4 (FBD)/ 1987>1989, Fiesta Iii 1.4/1.6 XR2i/ 1989>1995, Orion Ii 1.4/1.6 i/ 1986>1990, Scorprio I 2.9 i 24V/ 1991>1994, Scorprio I Stufenheck 2.9 i 24V/ 1991>1994, Scorprio I Turnier 2.9 24V/ 1993>1994;

ISUZU: Trooper Ii 3.2/ 1991>1998, Trooper Ii Geländewagen Offen 3.2/ 1991>1998 SAAB 9-3 2.0 Turbo/2.0 SE Turbo/ 1998>2002, 9-3 Cabriolet 2.0 Turbo/2.0 SE Turbo/ 1998>2003, 9-5 Kombi 2.3 i BioPower/ 2006>2009, 900 I Combi Coupe 2.0 S Turbo-16/2.0 Turbo-16/ 1985>1994, 900 I 2.0 S Turbo-16/2.0 Turbo-16/ 1985>1993, 900 I Cabriolet 2.0 S Turbo-16/2.0 Turbo-16/ 1986>1994, 900 Ii 2.0 -16 Turbo/ 1993>1998, 900 Ii Coupe 2.0 -16 Turbo/ 1993>1998, 900 Ii Cabriolet 2.0 -16 Turbo/ 1993>1998, 9000 Schrägheck 2.0 -16 ND Turbo/2.0 -16 Turbo/2.0 -16 Turbo CS/2.3 -16 CSE Eco Power/2.3 -16 Turbo/2.3 -16 Turbo CSE/2.3 -16 Aero CS/ 1984>1998, 9000 2.0 -16 Turbo CD/2.0 -16 CD/2.0 -16 Turbo/2.3 -16 CDE Eco-Power/2.3 -16 Turbo/2.3 -16 CD Turbo/ 1985>1998;

HONDA: Civic Iv Stufenheck 1.4 L (ED2)/1.6 i 16V (ED4)/1.6 i 16V 4x4/ 1987>1991, Prelude 2.0 S Verify fitment 1990, Prelude 2.0 Si Verify fitment 1990, Prelude Si Verify fitment 1990, Prelude Si 4WS Verify fitment 1990, Prelude Si ALB Verify fitment 1990, Prelude 2.0 S Verify fitment 1989, Prelude 2.0 Si Verify fitment 1989, Prelude 2.0 Si 4WS Verify fitment 1989, Prelude 2.0 S Verify fitment 1988, Prelude 2.0 Si Verify fitment 1988, Prelude 2.0 Si 4WS Verify fitment 1988;

ACURA: Integra LS Verify fitment 1987, Integra LS Special Edition Verify fitment 1987, Integra RS Verify fitment 1987, Integra LS Verify fitment 1986, Integra RS Verify fitment 1986



GV6R30 // NEW //

Pack with 04 Spark Plugs | Paquete con 04 bujías

REPLACES / REEMPLAZA:

NGK: LFR6B; Denso: K20HR-U11, KH20TT

APPLICATION / APLICACIÓN:

CITROËN: Berlingo / Berlingo First Großraumlimousine 1.6 16V (MFNFU)/ 2000>2011, Berlingo / Berlingo First Kasten 1.6 16V (MBNFU)/ 2000>2008, Berlingo 1.6/ 2008>, C2 1.6/1.6 VTS/ 2003>2010, C3 I 1.6 16V/ 2002>2010, C3 Pluriel 1.6/ 2003>, C4 I 1.6 16V/ 2004>2011, C4 I Stufenheck 1.6 16V/ 2006>2011, C4 Coupe 1.6 16V/2.0 16V/ 2004>2011, Xsara 1.6 16V/ 2000>2005, Xsara Break 1.6 16V/ 2000>2005, Xsara Coupe 1.6 16V/ 2000>2005, Xsara Picasso 1.6 16V/ 2005>2011;

PEUGEOT: 206 Hatch 1.6 16V/ 2000>2009, 206 Saloon 1.6 16V/ 2007>, 206 Sw Estate 1.6 16V/ 2002>, 206 Cc Convertible 1.6 16V/ 2000>2007, 206 Cc Convertible 1.6 16V/ 2000>2007, 207 Hatch 1.6 16V/ 2006>2013, 307 Hatch 1.6 16V/2.0 16V/ 2000>2007, 307 Estate 1.6 16V/ 2002>2008, 307 Sw Estate 1.6 16V/ 2002>2008, 307 Cc Convertible 1.6 16V/ 2003>2009, 308 Hatch 1.6 BioFlex/ 2008>2014, 1007 1.6 16V/ 2005>, Partner Mk 1 Mpv 1.6 16V/ 2001>2008, Partner Mk 2 Mpv 1.6 VTi/ 2008>, Partner Mk 2 Van 1.6/ 2008>



GV6R31 // NEW //

Pack with 04 Spark Plugs | Paquete con 04 bujías

REPLACES / REEMPLAZA:

NGK: BKR6E-D

APPLICATION / APLICACIÓN:

CHRYSLER: Stratus 2.0 16V 1995>2001, Stratus 2.0 Le 1995>2001;

CITROËN: Ax 11 1986>1997, Berlingo / Berlingo First Furgão 1.4 I Bivalent 2003>2005, Berlingo / Berlingo First Monovolume 1.4 I Bivalent 2003>2008, Bx 11 1988>1992, Bx 14 E 1982>1988, Bx 14 E 1985>1993, Bx 16 1985>1993, Bx 16 E 1989>1993, Bx 19 1986>1989, Bx Break 16 1985>1994, Bx Break 16 1989>1994, Bx Break 16 1985>1988, Bx Break 19 1987>1989, C2 1.1 2003>2012, C2 1.4 2003>2009, C3 I 1.1 I 2002>, C3 I 1.4 I 2002>2010, C3 I 1.4 I Bivalent 2002>, C3 Ii 1.1 I 2009>2013, C3 Ii 1.4 2009>2016, C3 Pluriel 1.4 2003>, Jumper Furgão 2.0 Bivalent 2003>, Jumper Van Passanger 2.0 Bivalent 2003>, Zx 1.6 I 1991>1997, Zx Break 1.6 I 1993>1997;

DAIHATSU: Charade Iii 1.0 Gti 1987>1992;

KIA: Carens I 1.8 I 2000>2002, Carens Ii Monovolume 1.8 2002>, Rio Hatch 1.5 16V 2000>2005, Rio Sedan 1.5 16V 2000>2005, Roadster 1.8 1999>, Sephia 1.8 I 16V 1995>1997, Sephia Sedan 1.8 I 16V 1995>1997, Shuma 1.8 I 16V 1997>2001, Sportage Veículo Off Road Fechado 2.0 I 4Wd 1994>1999;

MAZDA: 323 C Iv 1.8 16V 1989>1993, 323 F Iv 1.8 16V 1989>1993;

MITSUBISHI: Space Wagon 1.8 1991>1998;

OPEL: Calibra A 2.0 I 16V 1990>1994, Calibra A 2.0 I 16V 4X4 1990>1994;

PEUGEOT: 106 I 1.0 1991>1996, 106 I 1.1 1991>1996, 106 I 1.4 1991>1996, 106 I 1.6 1993>1996, 106 I 1.6 1994>1996, 106 Ii 1.0 I 1996>1999, 106 Ii 1.1 I 1997>2001, 106 Ii 1.1 I 1996>2004, 106 Ii 1.4 I 1996>2004, 106 Ii 1.6 S16 1996>2004, 106 Ii 1.6 I 1996>1999, 106 Ii 1.6 I 1996>2001, 205 Furgão 1.1 1987>1990, 205 I Conversivel 1.1 Cj 1989>1994, 205 I Conversivel 1.4 Cj 1989>1994, 205 I Conversivel 1.4 Cj 1991>1994, 205 I Conversivel 1.4 Cj Cat 1989>1993, 205 I Conversivel 1.6 Cj 1992>1994, 205 I Conversivel 1.9 Cti 1987>1994, 205 I Conversivel 1.9 Cti 1987>1990, 205 Ii 1.1 1987>1990, 205 Ii 1.1 1987>1992, 205 Ii 1.1 1989>1998, 205 Ii 1.4 1987>1990, 205 Ii 1.4 1988>1998, 205 Ii 1.4 1988>1998, 205 Ii 1.4 Cat 1987>1993, 205 Ii 1.6 1987>1998, 205 Ii 1.6 1987>1998, 205 Ii 1.6 1990>1992, 205 Ii 1.6 Aut. 1990>1998, 205 Ii 1.6 Gtx 1987>1991, 205 Ii 1.9 Gti 1987>1989, 205 Ii 1.9 Gti 1987>1994, 205 Ii 1.9 Gti Cat 1987>1994, 206 Hatch 1.1 1998>2000, 206 Hatch 1.1 I 1998>2007, 206 Hatch 1.4 I 1998>2012, 206 Hatch 1.6 I 1998>2000, 206 Sw 1.1 2002>, 206 Sw 1.4 2002>2007, 206 Sedan 1.4 2007>, 206+ 1.1 2009>2013, 206+ 1.4 I 2010>2013, 207 Sw 1.4 2007>2012, 305 Ii 1.6 1986>1988, 305 Ii 1.6 1982>1988, 305 Ii 1.9 1986>1988, 305 Ii Break 1.9 1986>1988, 306 1.4 Si 1994>2001, 306 1.4 Si 1994>2001, 306 1.6 Sr 1994>2000, 306 Break 1.4 1997>2002, 306 Break 1.6 1997>2000, 306 Conversivel 1.6 1996>2000, 306 Hatch 1.4 1993>2001, 306 Hatch 1.4 1993>2001, 306 Hatch 1.6 1993>2000, 307 1.4 2000>2003, 307 Break 1.4 2002>2003, 307 Sw 1.4 2002>2003, 309 I 1.1 1985>1989, 309 I 1.3 1985>1989, 309 I 1.4 1989>1989, 309 I 1.6 1987>1989, 309 I 1.6 1985>1989, 309 I 1.6 1986>1989, 309 I 1.9 1986>1989, 309 I 1.9 1985>1989, 309 I 1.9 1988>1989, 309 I 1.9 Gti 1988>1989, 309 Ii 1.1 1990>1993, 309 Ii 1.4 1990>1993, 309 Ii 1.6 1989>1993, 309 Ii 1.6 1989>1993, 309 Ii 1.6 1989>1993, 309 Ii 1.9 1989>1993, 309 Ii 1.9 1990>1993, 309 Ii 1.9 Gti 1989>1993, 405 I 1.6 1987>1992, 405 I 1.6 1987>1988, 405 I 1.6 1987>1992, 405 I 1.6 1989>1992, 405 I 1.6 1987>1992, 405 I 1.9 1987>1992, 405 I 1.9 1987>1992, 405 I 1.9 1989>1992, 405 I 1.9 4X4 1988>1992, 405 I 1.9 Injection 1987>1992, 405 I Break 1.4 1988>1992, 405 I Break 1.6 1988>1992, 405 I Break 1.6 1988>1992, 405 I Break 1.6 1988>1992, 405 I Break 1.6 1988>1992, 405 I Break 1.9 1988>1992, 405 I Break 1.9 1988>1992, 405 I Break 1.9 1988>1992, 405 I Break 1.9 1988>1992, 405 I Break 1.9 1988>1992, 405 Ii 1.6 1992>1995, 405 Ii 1.8 1992>1995, 405 Ii 2.0 1992>1995, 405 Ii 2.0 Mi-16 1992>1995, 405 Ii 2.0 X4 1992>1995, 405 Ii Break 1.4 1993>1994, 405 Ii Break 1.4 1992>1996, 405 Ii Break 1.6 1992>1996, 405 Ii Break 1.6 1992>1996, 405 Ii Break 1.8 1992>1996, 405 Ii Break 2.0 1992>1996, 405 Ii Break 2.0 4X4 1992>1996, 605 2.0 1990>1999, 806 2.0 1994>2002, Bipper 1.4 2008>, Boxer Caminhão De Plataforma/Chassis 2.0 I 1994>2002, Boxer Furgão 2.0 I 1994>2002, Boxer Van Passanger 2.0 I 1994>2002, Partner Comspace 1.4 2002>2006, Partner Comspace 1.4 1996>2015, Partner Furgão 1.4 1996>2015, Partner Furgão 1.4 Bifuel 2003>2006



GV6R37 // NEW //

Pack with 04 Spark Plugs | Paquete con 04 bujías

REPLACES / REEMPLAZA:

NGK: BPR6EYZ; Denso: W20EXR-U, W20TT; Magneti Marelli: 062130011312

APPLICATION / APLICACIÓN:

ASTON MARTIN: Lagonda I 5.3 1976>1997, Lagonda I Shooting Brake 5.3 1976>1997;

DAIHATSU: Charade Ii 1.0 Turbo 1983>1987, Charade Iii 1.0 Turbo 1987>1990, Cuore I 0.5 1980>1985, Cuore I 0.6 1982>1985, Cuore Ii 0.8 1989>1990, Cuore Ii 0.8 1985>1990, Cuore Ii 0.8 4Wd 1986>1988, Cuore Iii 0.8 1990>1994, Cuore Iv 0.8 1996>1998;

FORD: Sierra Hatch 2.0 1985>1986, Taunus 2.0 1975>1979;

HONDA: Integra Hatch 1.5 1985>1989, Prelude Ii 1.8 Ex 1985>1987, Prelude Ii 1.8 Ex 1983>1987;

MAZDA: 626 Ii 2.0 1983>1987, 626 Ii 2.0 1986>1987, 626 Ii Hatchback 2.0 1985>1987, 626 Ii Hatchback 2.0 1983>1987, 626 Ii Hatchback 2.0 1986>1987, 626 Iii 2.0 1987>1990, 626 Iii 2.0 12V 1987>1992, 626 Iii Coupé 2.0 1987>1990, 626 Iii Coupé 2.0 12V 1987>1988, 626 Iii Hatchback 2.0 1987>1990, 626 Iii Hatchback 2.0 12V 1987>1992, 626 Iii Station Wagon 2.0 1988>1997, E-Serie Furgão E2000 1991>1994, E-Serie Furgão E2000 1994>2003;

SUZUKI: Samurai Vehicle Off Road Fechado 1.3 Tração Integral 1988>2004, Samurai Vehicle Off Road Fechado 1.3 Tração Integral 2000>2004;

TOYOTA: Celica 2.0 Gt 1977>1981, Celica Coupé 1.6 Gt 1974>1978, Celica Coupé 1.6 Gt 1980>1981, Celica Coupé 1.6 Gt 1978>1981, Celica Coupé 2.0 1982>1985, Celica Coupé 2.0 1982>1985, Corolla Hatch 1.6 Gt 1980>1983, Cressida Sedan 2.0 Gli 1982>1985, Starlet 1.0 1984>1989, Starlet 1.0 1989>1992



GV6R38P-11 // NEW //

Pack with 04 Spark Plugs | Paquete con 04 bujías

REPLACES / REEMPLAZA:

NGK: PLZKAR6A-11D

APPLICATION / APLICACIÓN:

NISSAN: Evalia Van De Passageiro 1.6 16V 2010>, Micra C+C Iii 1.6 160 Sr 2005>, Micra Iii 160 Sr 2005>2010, Nv200 Furgão Compacto 1.6 16V 2010>, Qashqai / Qashqai +2 I 1.6 2007>2013, Qashqai / Qashqai +2 I 2.0 Tração Integral 2007>2013, Tiida Hatch 1.8 2007>2011, Tiida Hatch 1.8 2007>2011, Tiida Sedan 1.8 2007>2012, Tiida Sedan 1.8 2007>2012, X-Trail 2.0 2007>2013, X-Trail 2.0 2008>2013, X-Trail 2.0 Fwd 2007>2013, X-Trail 2.0 Fwd 2008>2013;

RENAULT: Clio Iii 2.0 16V 2006>, Fluence 1.6 16V 2010>, Fluence 2.0 16V 2010>, Grand Scénic Iii 2.0 16V 2009>, Laguna Iii 2.0 16V 2007>2012, Laguna Iii 2.0 16V Hi-Flex 2007>2015, Laguna Iii Grandtour 2.0 16V 2007>2015, Laguna Iii Grandtour 2.0 16V Hi-Flex 2007>2015, Latitude 2.0 16V 2011>, Latitude 2.0 16V Eco2 Flexfuel 2011>, Megane Cc 2.0 Cvt 2010>, Megane Iii Coupé 2.0 Cvt 2009>, Megane Iii Grandtour 2.0 Cvt 2009>, Megane Iii Hatch 2.0 Cvt 2009>, Scénic Iii 2.0 16V 2009>



GV6R39I-11 // NEW //

Pack with 04 Spark Plugs | Paquete con 04 bujías

REPLACES / REEMPLAZA:

NGK: DIFR6B11D

APPLICATION / APLICACIÓN:

MITSUBISHI: Outlander Ii 2.0 2006>2012, Outlander Ii 2.0 2006>2012, Outlander Ii 2.4 2006>2012, Outlander Ii 2.4 4Wd 2007>2012, Outlander Iii 2.0 Hybrid 4Wd 2012>



GV6R40-11 // NEW //

Pack with 04 Spark Plugs | Paquete con 04 bujías

REPLACES / REEMPLAZA:

NGK: BKR6EYA-11D

APPLICATION / APLICACIÓN:

AUSTIN: Montego 1.6 Ls,Hi 1984>1988, Montego Sw 1.6 Ls 1984>1988;

GM: Aveo / Kalos Hatch 1.4 16V 2003>2008, Aveo / Kalos Sedan 1.4 2005>2007, Aveo / Kalos Sedan 1.4 2008>, Lacetti 1.4 16V 2005>, Lacetti 1.6 2005>, Nubira Sw 1.6 2005>2011, Nubira Sedan 1.6 2005>2011, Rezzo Monovolume 1.6 2005>;

DAEWOO: Espero 1.5 16V 1993>1994, Espero 1.5 16V 1995>1999, Kalos 1.4 16V 2003>, Kalos Sedan 1.4 2003>2004, Lacetti Hatch 1.4 2004>, Lacetti Hatch 1.6 2004>, Lanos 1.6 16V 1997>, Lanos Sedan 1.6 16V 1997>, Nexia 1.5 16V 1995>1997, Nexia Sedan 1.5 16V 1995>1997, Nubira 1.6 16V 1997>1999, Nubira Sedan 1.6 16V 2000>, Nubira Sedan 1.6 16V 1997>1999, Nubira Wagon 1.6 16V 2000>, Nubira Wagon 1.6 16V 1997>1999, Rezzo 1.6 2000>, Rezzo 1.6 Sx 2001>2004;

DAIHATSU: Applause I Hatch 1.6 16V 1989>1997, Applause I Hatch 1.6 16V 1989>1997, Applause I Hatch 1.6 16V 4Wd 1989>1997, Applause I Hatch 1.6 16V 1997>2000, Charade Iv 1.3 1996>1999, Charade Iv 1.3 16V 1996>1999, Charade Iv 1.3 I 16V 1993>2000, Charade Iv 1.5 I 16V 1997>1999, Charade Iv 1.6 Gti 1993>1999, Charade Iv Sedan 1.5 16V 1994>2001, Cuore V 1.0 I 1998>2003, Feroza Hard Top 1.6 16V 4X4 1988>1999, Feroza Hard Top 1.6 I 16V 4X4 1988>1999, Feroza Soft Top 1.6 16V 1988>1999, Feroza Soft Top 1.6 I 16V 1988>1999, Gran Move 1.5 16V 1996>1998, Gran Move 1.6 16V 1998>, Sirion 1.0 I 1998>2000, Sirion 1.0 I 2000>2005, Sirion 1.0 I 4Wd 1999>2000, Sirion 1.0 I 4Wd 2000>2005;

HONDA: Civic Ii Shuttle 1.5 I 16V 1988>1991, Civic Ii Shuttle 1.6 I 16V 4Wd 1988>1989, Civic Ii Shuttle 1.6 I 16V 4Wd 1988>1995, Civic Iv Hatchback 1.3 16V Cat 1989>1991, Civic Iv Hatchback 1.4 L 1987>1989, Civic Iv Hatchback 1.5 I 16V 1988>1991, Civic Iv Hatchback 1.5 I 16V 1988>1991, Civic Iv Hatchback 1.6 I 16V Vtec 1989>1991, Civic V Coupé 1.6 I Vtec 1994>1996, Civic V Hatchback 1.3 16V 1991>1995, Civic V Hatchback 1.5 I 16V 1991>1995, Civic V Hatchback 1.5 I 16V 1991>1995, Civic V Hatchback 1.6 16V Vtec 1991>1995, Civic V Sedan 1.6 16V Vtec 1991>1995, Civic Vi Aerodeck 1.5 16V 1998>2001, Civic Vi Aerodeck 1.8 16V 1998>2001, Civic Vi Coupé 1.6 I Vtec 1996>2000, Civic Vi Fastback 1.4 I 1995>2001, Civic Vi Fastback 1.4 I 1995>2001, Civic Vi Fastback 1.5 16V 1997>2001, Civic Vi Fastback 1.6 1998>2000, Civic Vi Fastback 1.6 I 1994>1997, Civic Vi Fastback 1.6 I Vtec 1994>1997, Civic Vi Fastback 1.8 16V 1997>2001, Civic Vi Hatchback 1.4 I 1995>2001, Civic Vi Hatchback 1.4 I S 1995>2001, Civic Vi Hatchback 1.5 I 1995>2001, Civic Vi Hatchback 1.6 I 1995>2001, Civic Vi Sedan 1.4 I 1995>2001, Civic Vi Sedan 1.5 I 1995>2001, Civic Vi Sedan 1.6 I Vtec 1995>2001, Civic Vi Sedan 1.6 I Vtec 1995>2001, Cr-V I 2.0 16V 4Wd 1995>2001, Cr-V I 2.0 16V 4Wd 1999>2002, Crx I 1.6 I 16V 1986>1987, Crx Ii 1.6 I 16V Vtec 1989>1992, Crx Iii 1.6 Esi 1992>1998, Jazz Ii 1.2 I-Dsi 2002>2008, Jazz Ii 1.3 I-Dsi 2002>2008, Prelude Iii 2.0 1987>1992, Prelude Iii 2.0 Ex 1987>1992, Prelude Iii 2.0 I Ex 16V 1987>1990, Prelude Iii 2.0 I Ex 16V 1986>1987, Prelude Iii 2.0 I Ex 16V 1987>1992, Prelude Iii 2.0 I Ex 16V Cat 1987>1992, Prelude Iv 2.0 I 16V 1992>1996, Prelude Iv 2.2 I 16V Vtec 1993>1996, Prelude Iv 2.3 I 16V 1992>1996, Shuttle 2.2 16V 1994>1998, Shuttle 2.3 16V 1997>2004;

HYUNDAI: Accent I 1.3 I 12V 1994>2000, Accent Sedan 1.3 I 12V 1994>2000, Coupe 2.0 2001>2009, Coupe 2.0 Gls 2003>2009, Coupe 1.6 16V 1998>2002, Coupe 2.0 16V 2001>2002, Elantra 1.6 2000>2006, Elantra 1.8 2000>2006, Elantra 2.0 2003>2006, Elantra Sedan 1.6 2000>2006, Elantra Sedan 1.8 2000>2006, Elantra Sedan 2.0 2003>2006, Getz 1.1 2002>2005, Getz 1.1 2005>2009, Lantra Ii 1.5 12V 1996>2000, Lantra Ii 1.6 I 1995>2000, Lantra Ii 1.8 16V 1995>2000, Lantra Ii Sw 1.5 12V 1997>2000, Lantra Ii Sw 1.6 I 1996>2000, Lantra Ii Sw 1.8 16V 1996>2000, Sonata Iv 2.0 16V 1998>2001, Trajet 2.0 2000>2008...

CONTINUE

GV6R40-11 // NEW //

Pack with 04 Spark Plugs | Paquete con 04 bujías

REPLACES / REEMPLAZA:
NGK: BKR6EYA-11D

APPLICATION / APLICACIÓN:

...**KIA:** Carens li Monovolume 1.6 2002>, Clarus 1.8 l 16V 1996>2001, Clarus 2.0 l 16V 1996>2001, Clarus Sw 1.8 l 16V 1998>, Clarus Sw 2.0 l 16V 1998>, Retona Veículo Off Road Fechado 2.0 16V 2000>2001, Rio Hatch 1.5 16V 2002>2005, Rio li 1.6 Cvvt 2005>, Rio li Sedan 1.6 16V 2005>, Shuma 1.5 l 16V 1997>2001, Shuma Sedan 1.5 1996>1998, Shuma Sedan 1.5 l 16V 1997>2001, Sportage Veículo Off Road Fechado 2.0 l 16V 1999>2003, Sportage Veículo Off Road Fechado 2.0 l 16V 4Wd 1994>2003, Sportage Veículo Off Road Fechado 2.0 l 4Wd 1994>1999;

MAZDA: 121 li 1.3 16V 1990>1996, 121 li 1.3 l 16V 1990>1996, 323 C Iv 1.3 16V 1989>1994, 323 C Iv 1.6 16V 1991>1994, 323 C Iv 1.8 16V 4Wd 1991>1993, 323 C Iv 1.8 16V 1989>1993, 323 C Iv 1.8 16V Turbo 4Wd 1990>1992, 323 C Iv 1.8 16V Turbo 4Wd 1993>1994, 323 C V 1.3 16V 1994>1998, 323 C V 1.5 16V 1994>1998, 323 C V 1.8 16V 1994>1998, 323 F Iv 1.6 16V 1991>1994, 323 F Iv 1.8 16V 1989>1994, 323 F Iv 1.8 16V 1989>1994, 323 F Iv 1.8 4Wd 1991>1994, 323 F V 1.5 16V 1994>1998, 323 F V 1.8 16V 1994>1998, 323 F V 2.0 24V 1994>1998, 323 F V 2.0 24V 1994>1998, 323 F Vi 1.4 2001>2004, 323 F Vi 1.4 16V 1998>2001, 323 F Vi 1.5 16V 1998>2001, 323 F Vi 1.6 2001>2004, 323 F Vi 1.6 2001>2004, 323 P V 1.3 16V 1996>1998, 323 P V 1.5 16V 1996>1998, 323 S Iv 1.3 16V 1991>1994, 323 S Iv 1.6 16V 1989>1996, 323 S Iv 1.8 16V 1989>1994, 323 S Iv 1.8 16V 1989>1994, 323 S Iv 1.8 16V Turbo 4Wd 1991>1994, 323 S V 1.3 16V 1994>1998, 323 S V 1.5 16V 1994>1998, 323 S V 1.8 16V 1994>1998, 323 S V 1.3 2001>2004, 323 S Vi 1.6 2001>2004, 323 S Vi 1.6 2001>2004, 323 S Vi 1.9 16V 1998>2004, 626 lii 2.0 16V 1987>1992, 626 lii Coupé 2.0 16V 1987>1990, 626 lii Hatchback 2.0 16V 1987>1990, 626 lii Station Wagon 2.0 16V 1988>1992, 626 lii Station Wagon 2.0 l 16V 1988>1997, 626 lv 1.8 l 1994>1997, 626 lv 1.8 l 1992>1997, 626 lv 2.0 l 1992>1997, 626 lv 2.0 l 4Wd 1992>1997, 626 lv Hatchback 1.8 1994>1997, 626 lv Hatchback 1.8 1991>1997, 626 lv Hatchback 2.0 l 1991>1997, 626 lv Hatchback 2.0 l 4Wd 1992>1997, Demio 1.3 16V 1998>2003, Demio 1.3 l 16V 1998>2000, Demio 1.5 16V 2000>2003, E-Serie Furgão E2000 1994>2003, Mpv l 3.0 l V6 1989>1999, Mpv l 3.0 l V6 1988>1999, Mx-3 1.6 1991>1993, Mx-3 1.6 l 1993>1998, Mx-3 1.8 l V6 1994>1997, Mx-3 1.8 l V6 1992>1994, Mx-5 l 1.6 1995>1998, Mx-5 l 1.6 1990>1994, Mx-5 l 1.8 1993>1998, Mx-5 li 1.6 16V 1998>2005, Mx-5 li 1.8 16V 1998>2005, Mx-6 2.0 1992>1997, Xedos 6 1.6 16V 1994>1999, Xedos 6 1.6 16V 1992>1994, Xedos 6 2.0 V6 1994>1999, Xedos 6 2.0 V6 1992>1994, Xedos 9 2.0 24V 1993>2000;

MITSUBISHI: 3000 Gt Coupé 3.0 l 24V 4Wd 1990>1999, Carisma 1.6 1995>2006, Carisma 1.6 1998>2006, Carisma 1.6 1997>2006, Carisma 1.6 2000>2006, Carisma 1.8 1995>1997, Carisma 1.8 Msx - 16V 1995>1997, Carisma Sedan 1.6 1996>2006, Carisma Sedan 1.6 1998>2006, Carisma Sedan 1.6 1997>2006, Carisma Sedan 1.6 2000>2006, Carisma Sedan 1.8 1996>1997, Colt Iv 1.6 1994>1996, Colt Iv 1.6 4Wd 1993>1995, Colt Iv 1.6 16V 1992>1996, Colt Iv 1.8 Gti 16V 1992>1996, Colt V 1300 2000>2003, Colt V 1600 2000>2003, Colt V 1600 Glx 1996>2000, Galant V 1.8 1994>1996, Galant V 2.0 Glsi 4Wd 1992>1996, Galant Vi Sw 2.0 2000>2003, Galant Vi Sw 2.0 1996>2000, Galant Vi Sw 2.5 V6 24V 2000>2003, Galant Vi Sw 2.5 V6 24V 1996>2000, L 400 Van De Passageiro 2.0 16V 1995>2000, Lancer Iv Hatch 1.6 16V 1992>1994, Lancer Iv Hatch 1.8 Gti 16V 1992>1993, Lancer V 1.6 16V 4Wd 1992>1996, Lancer V Station Wagon 1.6 16V 4Wd 1992>2003, Lancer Vii 1.3 2003>2013, Lancer Vii 1.6 2003>2013, Lancer Vii Sw 1.6 2003>2008, Pajero li 3.0 V6 24V 1997>1999, Pajero li 3.0 V6 24V 1994>1997, Santamo 2.0 16V 4Wd 1999>2004, Space Runner 1.8 4Wd 1996>1999, Space Runner 1.8 4Wd 1991>1999, Space Runner 2.0 16V 1997>1999, Space Runner 2.0 1999>2002, Space Star Monovolume 1.3 16V 2000>2004, Space Star Monovolume 1.3 16V 1998>2004, Space Star Monovolume 1.6 16V 2001>2004, Space Star Monovolume 1.6 16V 1998>2004, Space Star Monovolume 1.6 16V 2001>2004, Space Wagon 1.8 4Wd 1991>1998, Space Wagon 2.0 4Wd 1992>1998;

NISSAN: Almera l Hatchback 2.0 Gti 1996>2000, Maxima lii 3.0 l 1988>1994, Micra li 1.0 l 16V 1992>2000, Micra li 1.3 l 16V 1992>2000, Prairie Pro 2.4 l 1990>1994, Prairie Pro 2.4 l 4X4 1992>1994, Primera 2.0 16V 1999>2001, Primera Hatchback 2.0 16V 1999>2002, Primera Traveller 2.0 16V 1999>2001;

OPEL: Monterey A 3.2 1991>1994;

RENAULT: Espace lii 3.0 1996>1998;

SUBARU: Impreza Coupé 1.6 1996>2000, Impreza Coupé 1.6 Awd 1996>2000, Impreza Coupé 2.0 Awd 1995>2000, Impreza Sw 1.6 l 1998>2000, Impreza Sw 1.6 l Awd 1992>2000, Impreza Sw 1.6 l Awd 1998>2000, Impreza Sw 1.8 l Awd 1992>2000, Impreza Sw 2.0 l 16V Awd 1998>2000, Impreza Sw 2.0 l Awd 1995>2000, Impreza Sw 2.0 l Awd 2000>2006, Impreza Sw 2.0 Awd 2000>2007, Impreza Sedan 1.6 l 1992>2000, Impreza Sedan 1.6 l 1998>2000, Impreza Sedan 1.6 l Awd 1992>2000, Impreza Sedan 1.6 l Awd 1998>2000, Impreza Sedan 1.8 l Awd 1992>2000, Impreza Sedan 2.0 l Awd 1995>2000, Impreza Sedan 2.0 l Awd 1998>2000, Impreza Sedan 2.0 l Awd 2000>2009, Impreza Sedan 2.0 l Awd 2000>2009, Justy li 1.3 4X4 2001>2003, Legacy l 1800 4Wd 1989>1991, Legacy l 2000 4Wd 1991>1994, Legacy l 2200 4Wd 1989>1994, Legacy l Sw 1800 4Wd 1989>1994, Legacy l Sw 2000 1991>1993, Legacy l Sw 2000 4Wd 1991>1994, Legacy l Sw 2200 Super 4Wd 1989>1994, Legacy li 2.0 l 1994>1999, Legacy li 2.0 l 4Wd 1994>1999, Legacy li 2.2 l 4Wd 1996>1999, Legacy li 2.2 l 4Wd 1994>1999, Legacy li Sw 2.0 l 1994>1998, Legacy li Sw 2.0 l 4Wd 1994>1998, Legacy li Sw 2.2 l 4Wd 1996>1998, Legacy li Sw 2.2 l 4Wd 1994>1998, Legacy lii 2.0 Awd 1999>2003, Legacy lii 2.5 Awd 1998>2003, Legacy lii Sw 2.0 Awd 1998>2003, Legacy lii Sw 2.5 Awd 1998>2003, Legacy Iv 2.0 Awd 2003>2005, Legacy Iv Sw 2.0 Awd 2003>2005, Outback 2.5 Awd 2000>2003;

SUZUKI: Baleno 1.8 Gtx 1996>2002, Baleno Hatch 1.8 Gtx 1996>2002, Baleno Sw 1.8 l 16V 1996>2002, Grand Vítara l 1.6 4X4 1998>2003, Grand Vítara l 2.0 4X4 1998>2003, Grand Vítara l 2.5 V6 24V 4X4 1998>2003, Liana 1.6 4Wd 2002>, Liana 1.6 4Wd 2002>, Liana Hatch 1.6 4Wd 2002>2007, Vítara 2.5 V6 24V Tração Integral 1995>1998, Wagon R+ Hatch 1.3 4Wd 2001>;

TOYOTA: Avensis 2.0 1997>2000, Avensis Liftback 2.0 1997>2000, Avensis Sw 2.0 1997>2000, Camry 2.2 1991>1996, Camry 2.0 1986>1993, Camry 2.0 1986>1991, Camry 2.0 4Wd 1988>1991, Camry Sw 2.2 1991>1996, Camry Sw 2.0 1986>1993, Camry Sw 2.0 1986>1991, Carina E 2.0 Gti 1992>1997, Carina E 2.0 l 1993>1997, Carina E Sedan 2.0 1993>1997, Carina E Sedan 2.0 l 1992>1997, Carina E Sportswagon 2.0 Gti 1993>1997, Carina E Sportswagon 2.0 l 1995>1997, Carina li 2.0 Gti 1987>1992, Carina li Sw 2.0 1987>1992, Carina li Sedan 2.0 Gti 1987>1992, Celica Conversivel 2.0 Gt 1986>1989, Celica Coupé 1.6 Gt 16V 1986>1989, Celica Coupé 2.0 1987>1989, Celica Coupé 1.8 l 16V 1993>1999, Celica Hatch 1.6 Gt 16V 1985>1989, Celica Hatch 2.0 Gt 1985>1989, Mr 2 l 1.6 16V 1984>1990, Rav 4 l 2.0 4Wd 1994>2000

GV6R41-11 // NEW //

Pack with 04 Spark Plugs | Paquete con 04 bujías

REPLACES / REEMPLAZA:
NGK: DILFR6D11D

APPLICATION / APLICACIÓN:
TOYOTA: Camry 3.5 2006>2011, Etios 1.3/1.5 2012>2016

GV6R92

Alcohol / Gasoline / Bicombustível (Brazil) - Pack with 04 Spark Plugs | Alcohol / Gasolina / Bicombustível (Brasil) - Paquete con 04 bujías

REPLACES / REEMPLAZA:
AC Delco: FR2IS; **Bosch:** FR7DC, Sp, Sp 7, F000 KE0 P0; **Champion:** RC9YC4; **Denso:** Q20PR-U; **NGK:** BKR6E

APPLICATION / APLICACIÓN:
CHRYSLER: Néon 2.0 16V (Gasoline) 96>, Stratus 2.0 16V (Gasoline) - All;

FIAT: Fiorino 1.3 8V MPI, Fiorino, Furgão (Fire - Flex), (70 CV Gasoline, 71 CV Alcohol) (Flex - Alcohol) 07>, Fiorino 1.3 8V, Fiorino Furgão Fire (65 CV) 03>, Fiorino, Fiorino Pick-up 1.0 8V (MPI - Gasoline) 96>, Idea 1.4 8V, ELX Flex (80 CV Gasoline, 81 CV Alcohol) (Bicombustível) 05>, Marea 1.6 16V SX (106 CV) (Gasoline) 05>, Palio 1.0 8V (MPI - Gasoline) 96>, Palio 1.3 8V (Fire - Gasoline) 03>, Palio 1.3 8V (Fire - Flex/bicombustível) 04>, Palio Weekend 1.0 8V (MPI - Gasoline) 96>, Palio Weekend 1.3 8V (Fire - bicombustível - Gasoline) - todos (all), Punto 1.4 8V (MPI - Fire - Flex 85 CV Gasoline/86 CV Alcohol) (bicombustível) 07>, Siena 1.0 8V (MPI - Gasoline) 96>, Siena, Strada 1.3 8V (Fire - Gasoline) - todos (all), Uno 1.0 8V, Mille Fire (Gasoline) - All;

MERCEDES BENZ: CLK 230 2.3 16V Kompressor (Gasoline) 03/00>



GV6R93

Gasoline / Bicomcombustível (Brasil) - Pack with 04 Spark Plugs | Gasolina / Bicomcombustível (Brasil) - Paquete con 04 bujías

REPLACES / REEMPLAZA:

AC Delco: FR2LS; **Bosch:** FR7DE, Sp, Sp 7, F000 KE0 P0; **Champion:** RC9YCC; **NGK:** BKR6EZ

APPLICATION / APLICACIÓN:

FIAT: Doblo 1.6 16V (MPI - Gasoline) 01>, Brava 1.6 16V (MPI - Gasoline) 99>, Fiorino 1.3 8V Furgão Fire (65 CV) (Gasoline) 03>, Idea 1.4 8V, ELX (Flex - 80 CV Gasoline/81 CV Alc.) 05>, Linea 1.9 16V (Flex - 130 CV Gasoline/132 CV Alc.) 08>, Palio 1.3 8V, Siena, Strada Fire (Gasoline) 03>, Palio Weekend 1.3 8V (Fire - Flex - Gasoline) - All, Siena, Strada 1.3 8V (Fire - Gasoline) - All, Uno 1.0 8V, Mille Fire (Gasoline) - All); **RENAULT:** Scénic 2.0 16V (F4R) 07/00>;



GV6R94D

Gasoline - Pack with 04 Spark Plugs | Gasolina - Paquete con 04 bujías

REPLACES / REEMPLAZA:

Bosch: FR7LDC, Sp 0, F000 KE0 P 0; **Champion:** RC9BMC; **Denso:** K20TMR; **NGK:** BKR6EK

APPLICATION / APLICACIÓN:

BMW: 316i 1.6 Compact 09/93>;

FIAT: Brava 1.6 16V (MPI) 99>, Brava 1.8 16V 00>03, Doblo 1.6 16V (MPI) 01>, Marea, Marea Weekend 1.6 16V, 2.0/2.4 20V - All, Palio 1.6 16V (MPI) >99, Palio Weekend 1.0 8V (MPI) 96>, Siena 1.0 8V (MPI) 96>, Siena 1.6 16V (MPI) >99, Stilo 1.8 16V, 2.4 20V 02>, Strada 1.6 16V (MPI), >99;

GM: Astra 2.0 16V 98>, Corsa 1.0/1.6 16V - All, Meriva 1.8 16V DOHC (MPFI) 02>, Tigra 1.6 16V 11/94>, Vectra 2.0 16V DOHC (MPFI) 97>, Zafira 2.0 16V 01>;

PEUGEOT: 106 1.0 8V - All, 205 1.4 8V - All, 206 1.6 8V - All, 306 1.6 8V, XS (TU5JP) - All, 306 1.8 16V Soleil, Passion, Rallye - All, 405 1.9 16V - All, 406 3.0 V6 Coupé (ES9J4) 10/96>, Partner 1.8 - All;

RENAULT: Mégane 2.0 16V (F7R) - All, R19 1.8 16V (F7P 704 cat.) - All;



GV6R96

Gasoline - Pack with 04 Spark Plugs | Gasolina - Paquete con 04 bujías

REPLACES / REEMPLAZA:

AC Delco: CR44N; **Bosch:** WR7CP; **Champion:** RN4C; **Denso:** W20ESR; **NGK:** BR6ES

APPLICATION / APLICACIÓN:

GM: Celta 1.0 8V / VHC (70CV) - All, Corsa 1.0 8V / VHC (70CV) 02>



GV7R01

Alcohol / Gasolina / GNV / Bicomcombustível (Brasil) - Paquete con 04 bujías

REPLACES / REEMPLAZA:

Bosch: WR6DC+, Sp34, F000 KE0 P34; **NGK:** BPR7E, BPR7E-D

APPLICATION / APLICACIÓN:

ALFA ROMEO: 2300 / FNM 2000 / 2150 2.3/ 2.0/ 2.15 - DOHC

FIAT: 147 / Panorama / Rallye 1050 / 1300, Elba 1.3 8V / Carburado 86>89, Elba 1.5 8V / Carburado 86>89, Elba 1.5 8v / Carburado (E201) 92>93, Elba 1.5 8V / SPI - Injeção 94>96, Elba 1.6 8V / Carburado-Distribuidor no cabeçote 90>94, Elba 1.6 8V / Carburado 90>94, Fiorino / Fiorino Pick-up 1.0 8V / carb. / inj. 93>96, Fiorino Pick-up 1.050 / 1.300 / carb. >89, Fiorino Pick-up 1.3 / 1.5 88>91, Fiorino Pick-up 1.5 / inj., Fiorino Pick-up 1.5 / carb. 92>, Fiorino Pick-up 1.6 / carb. 92>, Oggi 1.050 / 1.300 / 1.415, Prêmio 1.3 / 1.5 >91, Prêmio 1.5 / carb. >91, Prêmio 1.5 / carb. 92>, Prêmio 1.5 / inj. 92>, Prêmio 1.6 / carb. >91, Prêmio 1.6 / carb. 92>, Prêmio 1.6 / inj. 92>, Spazio 1.050 / 1.300 carb., Tempra 2.0 8V (carb.) 92>, Tempra 2.0 8V / spi 95>96, Uno 1.0 carb. / 1.0 i.e. / Mille 93>09/01, Uno 1.050 / 1.300 / carb. >89, Uno 1.3 85>91, Uno 1.3 / 1.5 carb. 90>91, Uno 1.5 carb., Uno 1.5 R >91, Uno 1.5 / 1.6 - inj. 92>, Uno 1.6 92>, Uno 1.6 mpi 95>, Uno 1.6 R / Carb. 90>93, Uno 1.6 R / MPI 94, Uno Furgoneta 1.3 / 1.5 >91, Uno Furgoneta 1.5 carb. 92>, Uno Furgoneta 1.5 i.e.

GM: Agile 1.4 8V / Econo.Flex (102 CV alc. / 97 CV Gasoline.) 09>, Agile 1.8 / 2.0 8V - SOHC mpi 00>, Astra 2.0 8V / Flexpower (133 CV Gasoline. / 140 CV alc.) 09>, Cobalt 1.4 / Econo.Flex (99 CV Gasoline / 105 CV alc.) 11>, Corsa 1.4 8V / Econo.Flex (99 CV Gasoline / 105 CV alc.) 06/07>, Ipanema 1.8 (carb.) >94, Ipanema 1.8 / 2.0 - efi, Ipanema 1.8 / 2.0 - efi (opcional cable) >94, Ipanema 2.0 - mpi >98, Kadett 1.8 - (carb.) >94, Kadett 1.8 / 2.0 - efi, Kadett 1.8 / 2.0 - efi (opcional cable) >94, Kadett 2.0 - mpi >98, Meriva 1.4 / Econo.Flex (99 CV Gasoline. / 105 CV alc.) 08>, Montana 1.4 8V / Econo.flex (99 CV Gasoline. - 105 CV alc.) 07>, Monza 1.8 / 2.0 - (carb.) >94, Monza 1.8 / 2.0 - efi >94, Monza 1.8 / 2.0 - efi (opcional cable) >94, Monza 2.0 - efi 95>, Monza 2.0 - mpi 95>, Omega / Suprema 2.2 4Cil. - mpi, Onix 1.4 8V / SPE (98 CV Gasoline. / 106 CV alc.) 10/12>, Prisma 1.4 8V / Econo Flex (89 CV Gasoline. / 97 CV alc.) 06>, Vectra 2.0 8V / Flexpower (133CV Gasoline. / 140CV alc.) 09>, Vectra GT / GTX 2.0 8V / Flexpower (133CV Gasoline./ 140CV alc.) 09>, Zafira 2.0 8V / Flexpower (133 CV Gasoline. / 140 CV alc.) 09>



GV7R02

GNV / Bicomcombustível (Brasil) - Pack with 04 Spark Plugs | GNV / Bicomcombustível (Brasil) - Paquete con 04 bujías

REPLACES / REEMPLAZA:

Bosch: FR5DE2, Sp30, F000 KE0 P30; **NGK:** BKR7ESB, BKR7ESB-D

APPLICATION / APLICACIÓN:

VW: Cross Fox 1.6 8V / Totalflex (101 CV Gasoline. / 103 CV alc. - EA 111 RSH / CCR Transf. 2X2) 05/08>, Fox 1.0 8V / Totalflex (68 CV Gasoline./71 CV alc. - EA-111 RSH) 04/05>, Fox 1.0 8V / Totalflex (72 CV Gasoline./76 CV alc. - EA- 111 RSH / VHT - CCN Tranf. 4X1) 05/08>, Fox 1.6 8V / Totalflex (101 CV Gasoline. / 103 CV alc. - EA 111 RSH / CCR Transf. 2X2) 05/08>, Gol 1.0 8V / Totalflex G4 (68CV Gasoline./71CV alc. - EA 111 RSH / CCP Transf. 2X2) 10/05> Gol 1.0 8v / Totalflex G5 (72 CV Gasoline. / 76 CV alc. - EA 111 RSH - VHT / CCN Transf. 2X2) 05/08>, Gol 1.0 8V / Totalflex G5 (72CV Gasoline. / 76CV alc. - EA 111 RSH - VHT / CCN Transf. 4X1) 08/09>, Gol 1.6 8V / Totalflex (101 / 103 CV - BWX) 10/05>, Gol 1.6 8V / Totalflex G5 (101 CV Gasoline. / 104 CV alc. - EA 111 RSH / CCR Transf. 2X2) 08>, Golf 1.6 8V / Totalflex (101 CV Gasoline. / 103 CV alc. - BPA / CCR Transf. 2X2) 05/08, Kombi 1.4 8V / Totalflex RSH (78CV Gasoline. / 80CV alc. - EA 111) 02/09>, Parati 1.6 8V / Totalflex (101 / 103 CV - BWX) 11/06>, Polo 1.6 8V / Totalflex (101 CV Gasoline. / 103 CV alc. - CCR Transf. 2X2) 05/08>, Polo Sedan 1.6 8V / Totalflex (101 CV Gasoline. / 103 CV alc. - BPA / CCR Transf. 2X2) 05/08>, Saveiro 1.6 8V / Totalflex (101 / 103 CV - BWX) 11/06>, Saveiro 1.6 8V / Totalflex G5 (101CV Gasoline. / 103CV alc. - CCR Transf. 2X2) 08/09>, Space Fox 1.6 8V / Totalflex (101CV Gasoline. / 103CV alc. - BPA / CCR Transf. 2X2) 05/08>, Voyage 1.0 8V / Totalflex (72 CV Gasoline. / 76 CV alc. - VHT/ CCNA Transf. 4X1) 07/08>, Voyage 1.6 8V / Totalflex (101 CV Gasoline. / 104 CV alc. - VHT / CCRATransf. 2X2) 07/08>



GV7R03

Gasoline / GNV / Bicomcombustível (Brazil) - Pack with 04 Spark Plugs | Gasolina / GNV / Bicomcombustível (Brasil) - Paquete con 04 bujías

REPLACES / REEMPLAZA:

NGK: LZKAR7A, LZKAR7A-D

APPLICATION / APLICACIÓN:

NISSAN: March 1.0 16V (74CV - D4D) 11>

PEUGEOT: 206 1.0 16V (D4D)

RENAULT: Clio 1.0 16V (D4D), Clio 1.0 16V / Hi-Flex (76 CV Gasoline./ 77 CV alc. - D4D) 05>, Kangoo 1.0 16V (D4D), Kangoo 1.0 16V / Hi-Flex (76 CV Gasoline./ 77 CV alc. - D4D) 05>, Logan 1.0 16V / Hi-Flex (76 CV Gasoline. / 77 CV alc. - D4D) 07>, Sandero 1.0 16V /Hi-Flex (76 CV Gasoline./ 77 CV alc. - D4D) 08>, Twingo 1.0 16v (D4D)



GV7R04-10

Gasoline / GNV - Pack with 04 Spark Plugs | Gasolina / GNV - Paquete con 04 bujías

REPLACES / REEMPLAZA:

Bosch: HR5M+U, Sp45, F000 KE0 P45; NGK: TR7B-10

APPLICATION / APLICACIÓN:

FORD: Ecosport 1.0 8V / Superchager (Zetec-Rocam) 03>05/06, Fiesta 1.0 8V / Superchager (Zetec-Rocam) (WCP) 02>07



GV7R05-10

GNV / Bicomcombustível (Brazil) - Pack with 04 Spark Plugs | GNV / Bicomcombustível (Brasil) - Paquete con 04 bujías

REPLACES / REEMPLAZA:

Bosch: HR5M+U, Sp45, F000 KE0 P45; NGK: LTR7A-10

APPLICATION / APLICACIÓN:

FORD: Ecosport 1.6 16V / Sigma (109CV Gasoline. / 116CV alc.) 12>, Fiesta 1.0 8V / Zetec Rocam Flex (71 CV Gasoline. / 73 CV alc.) 08/06>10/08, Fiesta 1.0 8V / Zetec Rocam Flex (69 CV Gasoline. - 73 CV alc.) 11/08>, Fiesta 1.6 16v / Sigma (110 CV Gasoline. / 115 CV alc.) 05/10, Focus 1.6 16V / Sigma (109CV Gasoline. / 116CV alc.) 10>, Ka 1.0 8V / Zetec Rocam Flex (70 CV Gasoline. / 73 CV alc.) 08>



GV7R06

Gasoline / GNV / Bicomcombustível (Brazil) - Pack with 04 Spark Plugs | Gasolina / GNV / Bicomcombustível (Brasil) - Paquete con 04 bujías

REPLACES / REEMPLAZA:

BOSCH: FR5DC+, Sp39, F000 KE0 P39; NGK: BKR7E

APPLICATION / APLICACIÓN:

CHRYSLER (DODGE / JEEP): Grand Cherokee 4.7 (V8 J FI SOHC & H.O.) 02>04

FIAT: Bravo 1.8 16V (130 CV Gasoline. / 132 CV alc.) 11>, Doblò 1.8 16V / E.torQ (130 CV Gasoline. / 132 CV alc.) 11>, Doblò Adventure 1.8 16V / E.torQ (130 CV Gasoline. / 132 CV alc.) 11>, Idea 1.6 16V / E.torQ (115 CV Gasoline./117 CV alc.) - 1.8 16V / E.torQ (130 CV Gasoline. / 132 CV alc.) 11>, Linea 1.8 16V / E.torQ (130 CV Gasoline. / 132 CV alc.) 11>, Pálio 1.6 16V / E.torQ (115 CV Gasoline. / 117 CV alc.) 12>, Palio Adventure 1.8 16V / E.torQ (130 CV Gasoline. / 132 CV alc.) 11>, Punto 1.6 16V / E.torQ (115 CV Gasoline./117CV alc.) - 1.8 16V / E.torQ (130 CV Gasoline. / 132 CV alc.) 11>, Siena 1.6 16V / E.torQ (115 CV Gasoline. / 117 CV alc.) 11>, Grand Siena 1.6 16V / E.torQ (115 CV Gasoline. / 117 CV alc.) 12>, Strada 1.8 16V / E.torQ (130 CV Gasoline. / 132 CV alc.) 11>,

LIFAN: 320 1.4 16V (88 CV - LF479Q3) 10>, 620 1.6 16V / Talent (106 CV - LF481Q3) 11>



GV7R14I

Pack with 04 IRIDIUM Spark Plugs | Gasolina - Paquete con 04 bujías IRIDIUM

REPLACES / REEMPLAZA:

JAC MOTORS: 1026080GG013, KL7RAIP

APPLICATION / APLICACIÓN:

JAC: J2 1.4 2013>2014 , J3 1.4 2013>2014, J5 1.5 2013>2014



GV7R15P-08 // NEW //

Gasoline - Pack with 04 Spark Plugs | Gasolina - Paquete con 04 bujías

REPLACES / REEMPLAZA:

NGK: PFR7N-E

APPLICATION / APLICACIÓN:

VOLKSWAGEN: Gol 1.0 16v Turbo 2000>2002, Parati 1.0 16v Turbo 2000>

GV7R16I-11 // NEW //

Gasoline - Pack with 04 IRIIDIUM Spark Plugs | Gasolina - Paquete con 04 bujías IRIIDIUM

REPLACES / REEMPLAZA:

NGK: SILZKR7B-11

Kia/ Hyundai: 18846-11070

APPLICATION / APLICACIÓN:

HYUNDAI: Genesis coupe 3.8 V6 2008>2014, ix35 2.0 Gdi / 2.0 GDi 4WD 2013>, i40 2.0 GDI 2012>, i40 CW 2.0 GDI 2011>

KIA: Carens IV 2.0 Gdi 2013>, Optima 2.0 / 2.0 CVVL 2012>, Sportage 2.0 GDI / 2.0 GDI AWD 2014>

GV7R18 // NEW //

Gasoline - Pack with 04 Spark Plugs | Gasolina - Paquete con 04 bujías

REPLACES / REEMPLAZA:

NGK: DCPR7E

Denso: XU22EPR-U, XU22EP-U

Bosch: YR7DC, 0 242 135 515, 0 242 135 501

Suzuki: 09482-00448, 09482-00449, 09482-00488

APPLICATION / APLICACIÓN:

SUZUKI: Alto Mk4 hatch 1.1 2004>2008, Wagon R+ 1.0/1.2 1998>2000

GV7R20I // NEW //

Pack with 04 Spark Plugs | Paquete con 04 bujías

REPLACES / REEMPLAZA:

NGK: BPR7EIX; **Daihatsu:** NDIW 22, NDIW 22 A, 99906-910X9-003; **Honda:** 98079-57946; **Infiniti:** BY480-BPR7E; **Lexus:** 90098-72116;

Mazda: 0376-18-110, 1UD2-18-110, 1UN2-18-110; **Mitsubishi:** MZ 602 034, MZ 602 062; **Nissan:** BY480-BPR7E; **Saab:** 88 19 328; **Subaru:** 49001-0023;

Suzuki: 99000-79J80-W22, 99000-79K60-P7R; **Toyota:** 90098-72116

APPLICATION / APLICACIÓN:

ASTON MARTIN: V8 Vantage 5.3/ 1969>1989;

AUDI: 200 2.1 5T 1979>1982

GV7R21I // NEW //

Pack with 04 Spark Plugs | Paquete con 04 bujías

REPLACES / REEMPLAZA:

NGK: BKR7EIX

APPLICATION / APLICACIÓN:

PORSCHE: 911 3.6 GT3 2003>2005;

VOLVO: V70 2.3 T-5/2.3 Turbo 1995>2000

GV7R22P // NEW //

Pack with 04 Spark Plugs | Paquete con 04 bujías

REPLACES / REEMPLAZA:

NGK: PFR7S8EG; **Bosch:** 0 242 245 576; **Denso:** PK22PR8

APPLICATION / APLICACIÓN:

AUDI: A1 2.0 TFSI quattro/ 2012>2012, A3 1.8 TFSI/1.8 TFSI quattro/2.0 TFSI/2.0 TFSI quattro/S3 quattro/ 2004>2012, A3 Sportback 1.8 TFSI/1.8 TFSI quattro/2.0 TFSI/2.0 TFSI quattro/S3 quattro/ 2004>2013, A3 Cabriolet 1.8 TFSI/2.0 TFSI/ 2008>2013, A4 Cabriolet 2.0 TFSI 16V/ 2006>2009, A4 2.0 TFSI/2.0 TFSI quattro/ 2004>2008, A4 Avant 2.0 TFSI/2.0 TFSI quattro/ 2004>2008, A4 Allroad 2.0 TFSI quattro/ 2009>2016, A5 1.8 TFSI/2.0 TFSI/2.0 TFSI quattro/RS5 quattro/ 2007>2017, A5 Sportback 1.8 TFSI/2.0 TFSI/2.0 TFSI quattro/ 2009>2017, A5 Cabriolet 1.8 TFSI/2.0 TFSI/2.0 TFSI quattro/RS5 quattro/ 2009>2017, A6 2.0 TFSI/ 2005>2011, A6 Avant 2.0 TFSI/ 2005>2011, A8 2.0 TFSI hybrid/ 2012>2015, Q3 2.0 TFSI quattro/ 2011>2015, Q5 2.0 TFSI quattro/2.0 TFSI hybrid quattro/ 2008>2017, R8 4.2 FSI quattro/5.2 FSI quattro/ 2009>2015, R8 Spyder 5.2 FSI quattro/ 2016>, TT 1.8 TFSI/2.0 TFSI/2.0 TFSI quattro/2.0 TFSI quattro/ 2006>2014, TT Roadster 1.8 TFSI/2.0 TFSI/2.0 TFSI quattro/2.0 TFSI quattro/ 2007>2014;

SEAT: Alhambra 2.0 TSI/ 2010>, Altea 1.8 TFSI/2.0 TFSI/ 2006>2009, Altea XI 1.8 TFSI/2.0 TFSI/2.0 TFSI 4x4/ 2006>2009, Exeo 1.8 TSI/2.0 TFSI/ 2009>2013, Exeo St 1.8 TSI/2.0 TFSI/ 2009>2013, Leon 1.8 TSI/2.0 TFSI/2.0 Cupra R/ 2005>2012, Toledo Iii 1.8 TFSI/2.0 TFSI/ 2005>2009;

SKODA: Octavia Iii 1.8 TSI/2.0 RS/ 2005>2013, Octavia Iii Combi 1.8 TSI/1.8 TSI 4x4/2.0 RS/ 2005>2013, Superb Iii 1.8 TSI/1.8 TSI 4x4/2.0 TSI/ 2008>2015, Superb Iii Kombi 1.8 TSI/1.8 TSI 4x4/2.0 TSI/ 2009>2015, Yeti 1.8 TSI 4x4/ 2009>2017;

VW: Amarok 2.0 TSI/ 2010>2016, Beetle 2.0 TSI/ 2011>2016, Beetle Cabriolet 2.0 TSI/ 2011>2016, Eos 2.0 TFSI/2.0 TSI/ 2006>2015, Golf V 2.0 GTI/ 2004>2009, Golf V Variant 2.0/ 2007>2009, Golf VI Cabriolet 2.0 GTI/2.0 R/ 2012>2016, Jetta Iii 2.0 TFSI/ 2005>2010, Jetta Iii 2.0 TSI/ 2010>, Passat 1.8 TSI/2.0 FSI/ 2005>2010, Passat Variant 1.8 TSI/2.0 FSI/ 2005>2011, Passat Cc 1.8 TSI/2.0 TSI/ 2008>2012, Passat Alltrack 1.8 TSI/2.0 TSI 4motion/ 2012>2014, Cc 1.8 TSI/2.0 TSI/ 2011>2016, Polo 2.0 R WRC/ 2013>, Scirocco 2.0 TSI/2.0 R/ 2008>2017, Sharan 2.0 TSI/ 2010>, Tiguan 2.0 TFSI 4motion/2.0 TSI 4motion/ 2007>2018, Multivan T5 2.0 TSI/2.0 TSI 4motion/ 2011>2015, Transporter T5 Bus 2.0 TSI/2.0 TSI 4motion/ 2011>2015, Transporter T5 Kasten 2.0 TSI/2.0 TSI 4motion/ 2011>2015, Transporter T5 Pritsche/Fahrgestell 2.0 TSI/ 2012>2015, Multivan T6 2.0 TSI/2.0 TSI 4motion/ 2015>, Transporter T6 Bus 2.0 TSI/2.0 TSI 4motion/ 2015>, Transporter T6 Kasten 2.0 TSI/2.0 TSI 4motion/ 2015>, Transporter T6 Pritsche/Fahrgestell 2.0 TSI/ 2015>

GV7R23D // NEW //

Pack with 04 Spark Plugs | Paquete con 04 bujías

REPLACES / REEMPLAZA:
NGK: BKR7EKC-D

APPLICATION / APLICACIÓN:
AUDI: 100 2.0 E 16V 1992>1994, 100 Avant 2.0 E 16V 1992>1994, 80 2.0 E 16V 1992>1994, 80 2.0 E 16V Quattro 1992>1994, 80 Avant 2.0 E 16V 1993>1996, 80 Avant 2.0 E 16V Quattro 1992>1995, 90 2.0 20 V 1989>1991, 90 2.0 20 V Quattro 1988>1991, A6 2.0 16V 1994>1997, A6 2.0 16V Quattro 1994>1997, A6 Avant 2.0 16V 1994>1997, A6 Avant 2.0 16V Quattro 1994>1997, Cabriolet 2.0 16V 1995>1996, Coupe 2.0 16V 1992>1992, Coupe 2.0 16V 1992>1996, Coupe 2.0 20 V 1989>1991, Coupe 2.0 20 V Quattro 1989>1991;

CITROËN: Ax 14 1988>1992, Jumpy 1.6 1995>2000, Jumpy Furgão 1.6 I 1995>2000, Xm 3.0 V6 24V 1990>1994;

FIAT: Punto 1.4 Gt Turbo 1993>1997, Punto 1.4 Gt Turbo 1996>1999, Uno 1.3 Turbo I.E. 1987>1987, Uno 1.3 Turbo I.E. 1985>1989, Uno 1.4 Turbo I.E. 1989>1993;

PEUGEOT: 306 Hatch 2.0 S16 1996>2001;

RENAULT: 21 2.0 1990>1992, 21 2.0 4X4 1990>1992, 21 Sw 2.0 1990>1994, 21 Sedan 2.0 1990>1994, 21 Sedan 2.0 4X4 1989>1994, Safrane I 3.0 Biturbo 4X4 1993>1996;

SEAT: Toledo I 1.8 16V 1991>1999;

VW: Corrado 1.8 16V 1989>1992, Golf li 1.8 Gti 16V 1986>1990, Jetta li 1.8 16V 1987>1989, Passat 1.8 16V 1988>1989, Passat Variant 1.8 16V 1988>1989, Scirocco 1.8 16V 1985>1989

GV7R24 // NEW //

Pack with 04 Spark Plugs | Paquete con 04 bujías

REPLACES / REEMPLAZA:
NGK: BCPR7ES; **Denso:** Q22PR-U; **Magneti Marelli:** 62110280312

APPLICATION / APLICACIÓN:
ASTON MARTIN: Db7 Volante 3.2/ 1996>2000;

CITROËN: Dispatch Mk 1 Mpv 1.6/ 1995>2000, Dispatch Mk 1 Van 1.6 i/ 1995>2000;

FIAT: Punto Mk 1 Hatch 1.6/ 1994>1997, Punto Mk 1 Convertible 90 1.6/ 1994>1997, Scudo Mk 1 Estate 1.6/ 1996>2006, Tipo Hatch 1.6 i.e. (160.A1, 160.EC, 160.EB)/ 1992>1995;

FORD: Escort Mk 3 Hatch 1.1/1.6/1.6 XR3i/ 1980>1985, Escort Mk 3 Estate 1.6/ 1980>1985, Escort Mk 3 Convertible 1.6/1.6 i/ 1983>1985, Escort Mk 4 Hatch 1.6 XR3i/ 1986>1989, Escort Mk 4 Convertible 1.6 XR3i/ 1986>1990, Fiesta Mk 1 Hatch 1.3/1.6 XR2/ 1977>1983, Orion Mk 1 Saloon 1.6/1.6 i/ 1983>1986, Orion Mk 2 Saloon 1.6 i/ 1986>1990;

LANCIA: Dedra 1.6 i.e. (835AN)/1.6 LE Cat (835EB)/1.8 i.e. (835AT)/1.8 i.e. (835FA)/ 1993>1999, Dedra Sw 1.6 (835EB)/1.8 i.e. (835FA)/ 1994>1999, Delta Mk 2 Hatch 1.6 i.e. (836AD)/ 1993>1999, Y10 1.1 i.e. Fire (156AG)/1.1 i.e. Fire All-wheel Drive (156AG)/ 1989>1995;

PEUGEOT: 306 Hatch 2.0 S16/ 1994>201, 306 Saloon 2.0 S16/ 1994>201, Expert Mpv 1.6/ 1996>2000, Expert Van 1.6/ 1996>2000, Expert Mk 1 Flatbed 1.6/ 1996>2000

GV7R26 // NEW //

Pack with 04 Spark Plugs | Paquete con 04 bujías

REPLACES / REEMPLAZA:
NGK: BR7ES-D, BR7ES; **Bosch:** 0 242 245 521; **Denso:** W22ESR-U

APPLICATION / APLICACIÓN:
MITSUBISHI: Cordia Cabrio 1.8 Turbo ECi (A213A)/ 1984>1989, Galant Mk 2 Saloon 2.0 Turbo ECi (A164)/ 1982>1984, Galant Mk 3 Saloon 2.0 Turbo ECi (E15A)/ 1984>1990, Sapporo Mk 2 Coupe 2.0 Turbo ECi (A164)/ 1982>1983, Starion 2.0 Turbo ECi (A183A)/ 1982>1987

GV7R28 // NEW //

Pack with 04 Spark Plugs | Paquete con 04 bujías

REPLACES / REEMPLAZA:
NGK: BKR7E; **Bosch:** 0 242 245 536

APPLICATION / APLICACIÓN:
ALFA ROMEO: 75 Saloon 2.0 T.S. (162.4CB, 162.B4, 162.B4A)/2.0 T.S. Cat (162.B4A)/ 1985>1992, 155 Saloon 1.7 T.S. (167.A4D, 167.A4H)/1.8 T.S. (167.A4C, 167.A)/1.8 T.S. Sport (167.A4A, 167.A4C, 167.A4E)/1.8 T.S. (167.A4A, 167.A4C, 167.A4E)/2.0 T.S. (167.A2A, 167.A2D)/2.0 T.S. (167.A2D)/ 1992>1997, 164 Saloon 2.0 (164A2C, 164A2L, 164A2H)/2.0 T.S. (164.A2C, 164.A2L)/2.0 Twin Spark (164A2J)/2.0 T.S. (164.A2H)/2.0 T.S. (164.H3)/ 1987>1998;

FORD: Escort Mk 3 Hatch 1.1/1.6/1.6 XR3i/RS 1600i/ 1980>1985, Escort Mk 3 Estate 1.6/ 1980>1985, Escort Mk 3 Convertible 1.6/1.6 i/ 1983>1985, Escort Mk 4 Hatch 1.6 XR3i/ 1986>1989, Escort Mk 4 Convertible 1.6 XR3i/ 1986>1990, Fiesta Mk 1 Hatch 1.3/1.6 XR2/ 1977>1983, Fiesta Mk 2 Hatch 1.6 XR2 (FBD)/ 1984>1989, Orion Mk 1 Saloon 1.6/1.6 i/ 1983>1986, Orion Mk 2 Saloon 1.6 i/ 1986>1990;

SAAB: 9-3 Hatch 2.0 Turbo/ 1998>2002;

SEAT: Ibiza Mk 1 Hatch 1.2/1.2 i/1.5/1.5 i Cat/1.5 i/ 1985>1993, Malaga Saloon 1.2/1.2 i/1.5/1.5 i Cat/1.5 i/ 1985>1993

GV7R30 // NEW //

Pack with 04 Spark Plugs | Paquete con 04 bujías

REPLACES / REEMPLAZA:
NGK: BPR7ES

APPLICATION / APLICACIÓN:
ABARTH: Ritmo 125 Tc 2.0 1981>1987;

ALFA ROMEO: 145 1.4 I.E. 1994>1996, 145 1.6 I.E. 1994>1996, 146 1.4 I.E. 1994>1996, 146 1.6 I.E. 1994>1996, 155 2.0 16V Turbo Q4 1992>1997, 155 2.0 16V Turbo Q4 1992>1997, 164 3.0 V6 1992>1998, 33 1.3 1983>1989, 33 1.5 1986>1989, 33 1.5 Qv 1984>1989, 33 1.7 Qv 1988>1989, 33 1.5 1990>1993, 33 1.5 I.E. 1990>1991, 33 1.7 I.E. 1992>1994, 33 1.7 I.E. 1990>1994, 33 Sportwagon 1.7 1988>1989, 33 Sportwagon 1.7 I.E. 1992>1994, 33 Sportwagon 1.7 I.E. 1990>1992, 33 Sportwagon 1.7 I.E. 4X4 1990>1992, 75 1.8 Turbo 1986>1992, 75 1.8 Turbo I.E. 1986>1990, Alfasud 1.3 1978>1980, Alfasud 1.5 Ti 1979>1984, Alfasud 1.5 Ti 1978>1980, Alfasud Giardinetta 1.3 1978>1979, Alfasud Sprint 1.5 1978>1981, Giulia 1300 1964>1969, Giulia 1300 Super 1974>1978, Giulia 1300 Ti 1969>1975, Giulia Gt 1300 Super 1974>1978, Gt 1300 Junior 1966>1977, Gt 1600 1972>1977, Gt 1600 1971>1977;

ALPINE: Berlinette 1600 Sx 1976>1977... CONTINUE



GV7R30 // NEW //

Pack with 04 Spark Plugs | Paquete con 04 bujías

REPLACES / REEMPLAZA:

NGK: BPR7ES

APPLICATION / APLICACIÓN:

...ASTON MARTIN: Zagato Vantage 5.3 1986>1989;

AUDI: 100 1.9 1980>1982, 100 2.1 1977>1982, 100 2.1 1977>1982, 100 1.8 1986>1988, 100 1.8 1983>1989, 100 1.8 Cat 1985>1990, 100 1.8 Cat Quattro 1985>1990, 100 1.8 Quattro 1986>1990, 100 1.8 Quattro 1984>1988, 100 2.0 1986>1987, 100 2.0 1984>1987, 100 2.0 Cat 1988>1990, 100 2.1 1982>1984, 100 2.2 1984>1986, 100 2.2 1984>1988, 100 2.2 Cat 1989>1990, 100 2.2 Cat Quattro 1989>1990, 100 2.2 E Turbo Quattro 1986>1990, 100 2.2 E Quattro 1985>1986, 100 2.2 Turbo 1986>1990, 100 2.2 Quattro 1984>1988, 100 2.3 E 1986>1990, 100 2.3 E Quattro 1986>1990, 100 2.3 Quattro 1990>1990, 100 1.8 1968>1971, 100 1.8 1971>1974, 100 1.8 1968>1971, 100 Avant 1.9 1980>1982, 100 Avant 2.1 1977>1983, 100 Avant 2.1 1977>1983, 100 Avant 1.8 1983>1989, 100 Avant 1.8 Cat 1985>1990, 100 Avant 1.8 Cat Quattro 1985>1990, 100 Avant 1.8 Quattro 1986>1990, 100 Avant 1.8 Quattro 1984>1988, 100 Avant 2.0 1986>1987, 100 Avant 2.0 E 1985>1987, 100 Avant 2.0 E Cat 1988>1990, 100 Avant 2.1 1982>1984, 100 Avant 2.2 1984>1986, 100 Avant 2.2 1984>1988, 100 Avant 2.2 Cat 1989>1990, 100 Avant 2.2 Cat Quattro 1989>1990, 100 Avant 2.2 E Quattro 1985>1986, 100 Avant 2.2 Turbo 1986>1990, 100 Avant 2.2 Turbo Quattro 1986>1990, 100 Avant 2.2 Quattro 1984>1988, 100 Avant 2.3 1986>1990, 100 Avant 2.3 E Quattro 1986>1990, 100 Avant 2.3 Quattro 1990>1990, 200 2.1 5E 1979>1982, 200 2.1 5E 1983>1984, 200 2.2 1984>1985, 200 2.2 Turbo 1985>1991, 200 2.2 Turbo 1988>1990, 200 2.2 Turbo 1988>1990, 200 2.2 Turbo Quattro 1985>1991, 200 2.2 Turbo Quattro 1988>1990, 200 2.2 Turbo Quattro 1988>1990, 80 1.5 1972>1975, 80 1.8 1986>1986, 80 1.8 1983>1986, 80 1.8 1983>1986, 80 1.8 Cc Quattro 1985>1986, 80 1.8 Gte 1985>1986, 80 1.8 Gte 1984>1986, 80 1.8 Gte Quattro 1985>1986, 80 1.6 1990>1991, 80 1.8 E 1986>1991, 80 1.8 E Quattro 1986>1991, 80 1.8 S 1986>1991, 80 1.8 S Quattro 1986>1990, 80 1.8 S Quattro 1986>1991, 80 1.8 Quattro 1986>1990, 80 2.0 E Quattro 1988>1990, 80 2.0 Quattro 1988>1990, 80 2.0 Quattro 1990>1991, 80 1.6 E 1993>1994, 80 2.0 E 1991>1994, 80 Avant 1.6 E 1993>1996, 80 Avant 2.0 1992>1996, 80 Avant 2.0 E 1992>1996, 90 2.0 1986>1987, 90 2.0 1984>1987, 90 2.2 1984>1987, 90 2.2 1985>1987, 90 2.2 E Quattro 1985>1987, 90 2.2 E Quattro 1984>1987, 90 2.0 1988>1991, 90 2.2 E 1987>1991, 90 2.2 E Quattro 1987>1991, 90 2.3 E Quattro 1987>1991, 90 2.3 E Quattro 1987>1991, A6 2.0 1994>1997, A6 2.0 1994>1997, A6 Avant 2.0 1994>1997, Cabriolet 2.0 E 1993>1998, Coupe 1.8 Gt 1982>1988, Coupe 1.8 Gt 1986>1988, Coupe 2.0 1983>1986, Coupe 2.0 1986>1988, Coupe 2.1 Gt 1982>1987, Coupe 2.2 Gt 1984>1988, Coupe 2.2 Gt 1981>1987, Coupe 2.2 Quattro 1985>1988, Coupe 2.2 Quattro 1984>1988, Coupe 1.8 1989>1991, Coupe 2.0 1989>1996, Coupe 2.2 Quattro 1988>1991, Quattro 2.2 Turbo 1987>1989, Quattro 2.2 Quattro 1984>1987;

AUSTIN: Maestro 1.6 1983>1984, Maestro 2.0 Efi 1984>1990, Metro 1.3 Turbo 1983>1990, Montego 2.0 Mayfair 1984>1988, Montego 2.0 Turbo 1984>1988, Montego Sw 2.0 Hli 1984>1992;

AUTOBIANCHI: A 112 1.0 Abarth 1971>1975, A 112 1.0 Abarth 1974>1984;

BMW: 02 1600 Ti 1967>1969, 02 1600/2 1967>1971, 02 1602 1971>1975, 02 1802 1971>1975, 02 2002 1968>1975, 02 2002 Ti 1968>1972, 02 2002 Tii 1971>1975, 02 2002 Turbo 1974>1975, 02 Conversível 1600-2 1967>1971, 02 Conversível 2002 1971>1975, 02 Touring 1600 1971>1973, 02 Touring 1802 1971>1975, 02 Touring 2002 1971>1975, 02 Touring 2002 Tii 1971>1975, 1500-2000 1500 1962>1966, 1500-2000 1800 1969>1971, 1500-2000 1800 1963>1969, 1500-2000 1800 Ti 1963>1968, 1500-2000 2000 1970>1972, 1500-2000 2000 1968>1972, 1500-2000 2000 Ti / Tilux 1966>1972, 1500-2000 2000 Tii 1969>1972, 2000-3.2 Coupé 2000 C/Ca 1965>1970;

CHEVROLET: Aveo / Kalos Hatch 1.4 2005>2008, Aveo / Kalos Sedan 1.4 2005>;

CITROËN: Ami 10 Super 1973>1977, Ami Break 10 Super 1973>1977, Gs 1.0 1970>1977, Gs 1.1 1977>1980, Gs 1.1 1977>1981, Gs 1.2 1973>1979, Gs 1.3 1978>1986, Gs Break 1.0 1971>1977, Gs Break 1.1 1977>1980, Gs Break A 1.2 1973>1979, Gs Break A 1.3 1979>1986, Gs Break A Spezial 1980>1982, Gs X 2 1975>1979;

DAIHATSU: Charade Iii 1.0 Gti 1987>1992, Cuore Iv 0.8 1996>1998, Cuore Iv 0.8 1995>1998, Hijet Furgão 1.0 1992>1998, Hijet Furgão 1.0 I 1994>1998, Hijet Van Passenger 1.0 I 1994>1998, Move 0.8 1997>1999;

FERRARI: 208/308 Coupé 308 Gtb 1975>1980, 208/308 Coupé 308 Gtb Qv 1982>1985, 208/308 Coupé 308 Gts 1977>1980, 208/308 Coupé 308 Gts Qv 1982>1985, Mondial 8 1980>1983;

FIAT: 124 1200 1967>1975, 124 1200 1966>1973, 124 1400 Special 1968>1972, 124 1400 Special 1971>1975, 124 1500 Special T 1971>1975, 124 Coupé 1600 1973>1976, 124 Coupé 1600 1973>1976, 124 Coupé 1600 1973>1976, 124 Coupé 1600 1971>1973, 124 Coupé 1600 1970>1973, 124 Coupé 1600 1970>1973, 124 Coupé 1600 Sport 1972>1975, 124 Coupé 1600 Sport 1972>1975, 124 Coupé 1600 Sport 1972>1975, 124 Coupé 1600 Sport 1972>1975, 124 Coupé 1800 Sport 1973>1976, 124 Coupé 1800 Sport 1973>1976, 124 Familiare 1200 1967>1973, 124 Familiare 1200 1973>1975, 124 Spider 1600 1973>1975, 124 Spider 1600 1973>1975, 124 Spider 1600 Sport 1969>1973, 124 Spider 1600 Sport 1969>1973, 124 Spider 1600 Sport 1969>1973, 124 Spider 1600 Sport 1969>1974, 124 Spider 1600 Sport 1969>1974, 124 Spider 1600 Sport 1969>1974, 124 Spider 1600 Sport 1969>1974, 124 Spider 1600 Sport 1969>1974, 125 1.6 1967>1974, 126 650 1972>1977, 126 650 1977>1987, 126 650 1981>2000, 126 700 1987>1996, 127 1.0 Sport 1978>1982, 127 1.3 Sport 1981>1983, 131 2.0 Racing 1978>1981, 131 2.0 Super 1981>1984, 132 1.6 1977>1982, 132 1.6 1977>1981, 132 1.6 1976>1982, 132 1.6 1972>1976, 132 1.7 Gls 1974>1975, 132 1.7 Gls 1975>1977, 132 1.7 Special 1972>1974, 132 2.0 1976>1981, 850 0.8 1964>1972, 850 0.8 1964>1972, 850 0.8 Special 1968>1972, Cinquecento 0.7 I 1994>1998, Coupe 2.0 16V 1993>1996, Coupe 2.0 16V Turbo 1993>1996, Croma 1600 1985>1990, Croma 2000 16V 1992>1996, Croma 2000 Cht 1991>1992, Croma 2000 Cht 1985>1989, Croma 2000 I.E. 1987>1992, Croma 2000 I.E. 1986>1990, Croma 2000 I.E. 1987>1996, Croma 2000 I.E. Turbo 1986>1988, Croma 2000 I.E. Turbo 1985>1990, Croma 2000 I.E. Turbo 1987>1996, Croma 2500 V6 1993>1996, Fiorino Furgão 70 1.3 1988>1994, Fiorino Furgão 70 I.E. 1.4 1994>2001, Fiorino Furgão 75 I.E. 1.6 1993>2001, Fiorino Pick Up 1.6 1994>2001, Panda 900 1992>1996, Regata 100 Super 1.5 1983>1985, Regata Weekend 100 1.6 1984>1990, Regata Weekend 75 1.5 1983>1989, Regata 85 1.5 1985>1987, Regata 85 1.6 1983>1990, Regata 85 Super 1.5 1983>1985, Regata Weekend 100 1.6 1984>1990, Regata Weekend 75 1.5 1984>1989, Regata Weekend 85 1.5 1984>1989, Ritmo 1.3 1981>1982, Ritmo 1.5 1978>1988, Ritmo 1.5 1985>1987, Ritmo 1.5 1983>1987, Ritmo 1.5 1981>1987, Ritmo 1.6 1983>1987, Ritmo Conversível 100 1.6 1985>1987, Ritmo Conversível 100 1.6 1985>1987, Ritmo Conversível 85 1.5 1983>1986, Ritmo Conversível 85 1.5 1980>1989, Seicento / 600 0.9 1997>2008, Tempra 1.4 I.E. 1990>1996, Tempra 1.6 1990>1994, Tempra 1.6 I.E. 1990>1992, Tempra 1.6 I.E. 1992>1996, Tempra 1.8 I.E. 1992>1996, Tempra 1.8 I.E. 1993>1996, Tempra 1.8 I.E. 1993>1996, Tempra 1.8 I.E. 1994>1996, Tempra 2.0 I.E. 1990>1996, Tempra S.W. 1.4 I.E. 1992>1996, Tempra S.W. 1.6 1990>1993, Tempra S.W. 1.6 I.E. 1990>1996, Tempra S.W. 1.6 I.E. 1994>1996, Tempra S.W. 1.6 I.E. 1992>1996, Tempra S.W. 1.8 I.E. 1992>1993, Tempra S.W. 1.8 I.E. 1993>1996, Tempra S.W. 1.8 I.E. 1993>1996, Tipo 1.6 I.E. 1990>1993, Tipo 1.8 I.E. 1993>1995, Tipo 1.8 I.E. 1993>1995, Tipo 1.8 I.E. 1990>1993, Tipo 1.8 I.E. 1990>1993, Tipo 1.8 I.E. 1993>1995, Tipo 1.8 I.E. 1994>1995, Tipo 1.8 I.E. 16V Sport 1989>1992, Tipo 2.0 16V 1991>1995, Tipo 2.0 I.E. 1990>1992, Tipo 2.0 I.E. 1990>1995, Tipo 2.0 I.E. 16V Sport 1993>1995, Uno 70 S 1.4 1988>2006, Uno 70 I.E. 1.4 1989>1996, Uno 75 I.E. 1.5 1985>1993, X 1/9 1.3 1975>1978, X 1/9 1.3 1973>1979, X 1/9 1.5 1978>1989;

FORD: Capri 1700 1968>1972, Capri 2000 1969>1974, Capri 3000 1972>1974, Capri li 2.0 1976>1977, Capri li 2.3 1974>1977, Capri li 3.0 1974>1977, Capri lii 2.0 1978>1982, Consul 1700 1972>1975, Consul 1700 1972>1975, Consul 2000 1974>1975, Consul Coupé 1700 1972>1975, Consul Coupé 1700 1972>1975, Consul Turnier 1700 1972>1975, Consul Turnier 1700 1972>1975, Escort li 1.3 1974>1980, Escort li 1.3 1979>1980, Escort li 1.3 1974>1980, Escort li 1.6 Rs 1974>1980, Escort li Turnier 1.3 1975>1980, Granada 2.0 1975>1977, Granada 2.3 1972>1976, Granada 2.3 1975>1977, Granada 3.0 1972>1976, Granada 3.0 1972>1976, Granada 1.7 1977>1981, Granada 2.3 1977>1979, Granada 2.8 I 1977>1981, Granada Turnier 2.0 1975>1977, Granada Turnier 2.3 1972>1976, Granada Turnier 2.6 1972>1976, Granada Turnier 3.0 1972>1976, Granada Turnier 1.7 1977>1981, Granada Turnier 2.3 1977>1979, Taunus 80 2.0 1979>1982, Taunus 80 2.3 1979>1982, Taunus 2.0 1975>1979, Taunus 2.3 1975>1979, Taunus 15M 1.7 Xl/Rs 1968>1971, Taunus Turnier 2.0 1975>1979, Taunus Turnier 2.3 1975>1979, Taunus '80 Turnier 2.0 1979>1982, Taunus '80 Turnier 2.3 1979>1982;

FSO: 125P 1.3 1300 1967>1992, 125P 1.5 1500 1967>1992, 125P Sw 1.3 1967>1992, 125P Sw 1.5 1967>1992, Polonez I 1.5 1977>1988, Polonez I 1.5 1978>1988, Polonez Iii 1.6 I 1992>2002, Polonez Iii Sedan 1.6 I 1992>2002;

HYUNDAI: H-1 / Starex Monovolume 2.4 1997>2004, H-1 / Starex Monovolume 2.4 4Wd 1998>2004, H-100 Furgão 2.4 2000>2004, H100 Van Passenger 2.4 1997>2000, H100 Van Passenger 2.4 1993>2000, Santa Fé I 2.0 2001>2006, Santa Fé I 2.4 16V 2001>2006, Santa Fé I 2.4 16V 2001>2006, Santa Fé I 2.4 16V 4X4 2001>2006, Santa Fé I 2.4 16V 4X4 2001>2006, Santamo 2.0 16V 1999>2002, Santamo 2.0 16V 4X4 1999>2002, Sonata Iv 2.0 16V 2001>2004, Sonata Iv 2.0 16V 1998>2001, Trajet 2.0 2004>2008, Trajet 2.0 2000>2008;

JEEP : Cj5 - Cj8 2.0 1983>1987

CONTINUE...

GV7R30 // NEW //
Pack with 04 Spark Plugs | Paquete con 04 bujías
REPLACES / REEMPLAZA:
NGK: BPR7ES

APPLICATION / APLICACIÓN:
...KIA: Joice 2.0 2001>, Joice 2.0 2001>, Joice 2.0 2000>, Joice 2.0 2000>, Magentis 2.0 2001>2005, Sportage Vehículo Off Road Fechado 2.0 I 4Wd 1994>1999;

LADA : 110 1.5 1996>2004, 110 1.5 1995>2005, 110 1.5 2000>2005, 110 1.5 1995>2005, 110 1.5 16V 1995>2005, 110 1.6 2000>2012, 111 1.5 2000>2009, 111 1.5 1996>2005, 111 1.5 16V 1995>2002, 111 1.6 2004>2009, 111 1.6 2004>2007, 112 1.5 2000>2005, 112 1.5 1995>2004, 112 1.5 16V 2000>2005, 112 1.5 16V 1995>2000, 112 1.6 2005>2011, 1200-1500 Sw 1200 1973>1984, 1200-1500 Sw 1500 1973>1985, 1200-1600 1200 L/S 1970>1986, 1200-1600 1300 1978>1987, 1200-1600 1300 1974>1984, 1200-1600 1500 1972>1984, 1200-1600 1500 N/S 1975>1986, 1200-1600 1600 1984>1990, 1200-1600 1600 1972>1984, 1200-1600 1600 N/L 1979>2005, Granta 1.6 2011>, Kalina Hatch 1.6 2004>2013, Kalina li Hatch 1.6 2013>2018, Kalina Sw 1.6 2007>2013, Kalina Sedan 1.6 2004>2013, Niva Vehículo Off Road Fechado 1.7 Lpg 2002>2015, Niva Vehículo Off Road Fechado 1600 1976>1993, Niva Vehículo Off Road Fechado 1700 I 1996>2006, Niva Vehículo Off Road Fechado 1700 I 4X4 2000>2015, Niva Vehículo Off Road Fechado 1700 I 4X4 2004>, Nova 1200 Junior/L 1981>2012, Nova 1300 Spezial/L 1981>2012, Nova 1300 Spezial/L 1981>2012, Nova 1500 S 1989>2012, Nova 1500 Special 1985>2012, Nova 1600 1988>2001, Nova 1700 I Classic 1996>2012, Nova Sw 1300 1985>1994, Nova Sw 1500 1994>2012, Nova Sw 1500 1985>1993, Samara 1.5 1996>2013, Samara 1100 1988>1994, Samara 1100 1996>1999, Samara 1300 1991>1999, Samara 1300 1987>1996, Samara 1300 1986>1994, Samara 1500 1991>1996, Samara 1500 1987>1996, Samara Forma Sedan 1100 1991>1999, Samara Forma Sedan 1300 1991>1999, Samara Forma Sedan 1300 1990>1999, Samara Forma Sedan 1300 1989>1997, Samara Forma Sedan 1500 1991>1996, Samara Forma Sedan 1500 1994>2006, Samara Forma Sedan 1500 1991>1996, Samara Hatch 1.5 2003>2013, Taiga li 1.7 2002>, Taiga li 1.7 2004>, Toscana 1300 1985>2012, Toscana 1500 1983>1993;

LANCIA: A 112 1.0 Abarth 1978>1984, Beta H.P.E. 1600 1980>1984, Beta H.P.E. 2000 1979>1984, Beta H.P.E. 2000 1976>1978, Beta H.P.E. 2000 Volumex 1983>1984, Beta 1400 1973>1976, Beta 1600 1973>1982, Beta 1800 1973>1976, Beta 2000 1978>1982, Beta Coupé 1300 1981>1984, Beta Coupé 1300 1977>1981, Beta Coupé 1600 1974>1976, Beta Coupé 1600 1976>1984, Beta Coupé 1800 1974>1976, Beta Coupé 2000 1976>1984, Beta Coupé 2000 1981>1984, Beta Coupé 2000 Vx 1983>1984, Beta Monte Carlo 2.0 1975>1981, Beta Sedan 1300 1976>1982, Beta Sedan 1600 1976>1986, Beta Sedan 2000 1976>1978, Beta Spider 1600 1976>1986, Beta Spider 2000 1979>1986, Beta Spider 2000 1976>1979, Dedra 1.6 I.E. 1989>1994, Dedra 1.6 I.E. 1989>1993, Dedra 1.8 I.E. 1989>1994, Dedra 1.8 I.E. 1989>1999, Dedra 1.8 I.E. 1989>1999, Dedra 1.8 I.E. 1994>1999, Dedra 2.0 16V 1994>1999, Dedra 2.0 Hf Integrale 1990>1994, Dedra 2.0 Turbo 1990>1994, Dedra 2.0 I.E. 1989>1992, Dedra 2.0 I.E. 1989>1999, Dedra 2.0 I.E. Turbo 1991>1999, Dedra 2.0 I.E. Turbo Integrale 1990>1991, Dedra Sw 1.8 I.E. 1994>1999, Dedra Sw 2.0 16V 1994>1999, Dedra Sw 2.0 Integrale 1994>1999, Delta I 1.3 1979>1992, Delta I 1.5 1979>1992, Delta I 1.6 Gt 1982>1986, Delta I 1.6 Gt I.E. 1987>1992, Delta I 1.6 Gt I.E. 1986>1988, Delta I 1.6 Hf Turbo 1983>1986, Delta I 1.6 Hf Turbo 1986>1988, Delta I 1.6 Hf Turbo 1987>1989, Delta I 2.0 16V Hf Evo Integrale 1993>1994, Delta I 2.0 16V Hf Integrale 1989>1991, Delta I 2.0 Hf Integrale 1986>1988, Delta I 2.0 Hf Integrale 1987>1991, Delta I 2.0 Hf Integrale 1986>1992, Delta li 1.4 I.E. 1994>1999, Delta li 1.8 I.E. 1993>1999, Delta li 1.8 I.E. 1994>1999, Delta li 2.0 16V 1993>1999, Delta li 2.0 16V Turbo 1993>1999, Kappa 2.0 16V Turbo 1995>2001, Kappa Coupé 2.0 16V Turbo 1996>2001, Kappa Sw 2.0 16V Turbo 1996>2001, Prisma 1.5 1985>1992, Prisma 1.5 1986>1989, Prisma 1.5 1983>1986, Prisma 1.6 1987>1988, Prisma 1.6 1986>1992, Prisma 1.6 1983>1986, Prisma 1.6 I.E. 1986>1989, Prisma 1.6 I.E. Super 1987>1989, Prisma 2.0 I.E. Tração Integral 1987>1988, Prisma 2.0 I.E. Tração Integral 1986>1989, Thema 2000 16V 1992>1993, Thema 2000 16V Turbo 1988>1990, Thema 2000 16V Turbo 1992>1994, Thema 2000 I.E. 1988>1992, Thema 2000 I.E. 1986>1988, Thema 2000 I.E. 1984>1988, Thema 2000 I.E. 1987>1992, Thema 2000 I.E. 16V 1988>1992, Thema 2000 I.E. 16V 1989>1992, Thema 2000 I.E. 16V Turbo 1989>1992, Thema 2000 I.E. Turbo 1984>1989, Thema 2000 I.E. Turbo 1986>1990, Thema 3000 V6 1992>1994, Thema Sw 2000 16V 1992>1994, Thema Sw 2000 Turbo 1988>1992, Thema Sw 2000 Turbo 16V 1992>1994, Thema Sw 2000 I.E. 16V 1989>1992, Thema Sw 2000 I.E. 16V 1989>1992, Thema Sw 2000 I.E. 16V Turbo 1988>1990, Thema Sw 2000 I.E. 16V Turbo 1989>1993, Thema Sw 2000 I.E. Turbo 1987>1994, Thema Sw 3000 V6 1992>1994, Trevi 1600 1980>1987, Trevi 2000 Volumex 1983>1985, Trevi 2000 I.E. 1980>1987, Y10 1.3 I.E. 1989>1995;

LOTUS: Eclat 2.0 1975>1980, Eclat 2.2 1980>1986, Elite 2.0 1974>1980, Elite 2.2 1980>1982, Esprit S2 2.0 1975>1980, Esprit S2 2.2 Turbo 1980>1988, Esprit S3 2.2 1980>1986, Esprit S3 2.2 1980>1986, Esprit S4 2.2 16V Turbo Se 1989>1996, Excel 2.2 1983>1986, Excel 2.2 Se/Sa 1984>1991;

MASERATI: Biturbo 222 Se 1989>1994, Biturbo Spider 2.8 1989>1994, Ghibli 4.7 1967>1973, Ghibli Spider 4.7 1968>1973, Indy 4.7 1972>1974, Indy 4.9 1972>1974, Mexico 4.7 1967>1972;

MAZDA: 626 lii Station Wagon 2.0 1988>1997;

MERCEDES-BENZ: /8 250 1968>1972, /8 250 1968>1972, /8 Coupé 250 C 1969>1972, /8 Coupé 250 Ce 1969>1972, G-Class 230 G 1979>1993, G-Class 230 G 1980>1987, G-Class 500 Ge 1993>1994, S-Class 560 Se, Sel 1987>1991, S-Class 560 Se, Sel 1985>1987, S-Class 560 Se, Sel 1985>1991, S-Class Coupé 560 Sec 1985>1991, S-Class Coupé 560 Sec 1985>1987, S-Class Coupé 560 Sec 1985>1991, S-Class Sedan 300 Sel 1968>1972, S-Class Sedan 300 Sel 3.5 1970>1972, Sl 190 Sl 1955>1963;

MG: Maestro 2.0 Efi 1984>1990, Mgr V8 3.9 1992>1995;

MITSUBISHI: Cordia 1.8 Turbo Eci 1984>1989, Eclipse li 2000 Gs 16V 1995>1999, Galant Iv 2.0 1989>1992, Galant Iv 2.0 Gti 16V 1988>1992, Galant Iv Sedan 2.0 1987>1992, Galant Iv Sedan 2.0 Gti 16V Cat 4Wd 1991>1992, Galant Iv Sedan 2.0 Gti 16V 1987>1992, Galant Iv Sedan 2.0 Gti 16V 1988>1992, L 200 2.0 4Wd 1987>1994, L 300 / Delica li Furgão 1.8 1983>1986, L 300 / Delica li Van Passenger 1.8 1983>1986, Lancer Iv 1.3 12V 1990>1992, Lancer Iv Hatch 1.3 12V 1992>1994, Lancer V Evo li 1994>1995, Lancer V Evo lii 1995>1996, Santamo 2.0 16V 1999>2004, Santamo 2.0 16V 4Wd 1999>2004, Sapporo li 2.0 Gsl 1980>1983, Sapporo li 2.0 Gsr 1980>1984, Sapporo lii 2.4 1987>1990, Space Wagon 2.0 Glxi 1988>1991, Space Wagon 2.0 Glxi 4Wd 1988>1991, Starion 2.0 Turbo Eci 1982>1985, Starion 2.0 Turbo Eci 1985>1987;

MORGAN : Plus Four 2.0 I 1985>1988;

MOSKOVICH: 2141 1.5 1989>2001;

NISSAN: Pick Up 2.2 4Wd 1983>1986;

NSU: 1000 C 1963>1972, Prinz 1000 1969>1974, Prinz 600 1969>1971, Prinz 600 4L 1961>1970;

OPEL: Kadett E 1.2 1984>1986, Kadett E 1.6 S 1986>1991, Kadett E 1.6 S 1984>1986, Kadett E Combo 1.6 1986>1991, Kadett E Conversível 1.6 I 1989>1993, Kadett E Hatch 1.6 S 1986>1991, Kadett E Hatch 1.6 S 1984>1986, Kadett E Sw 1.2 1984>1986, Kadett E Sw 1.6 1986>1991, Kadett E Sw 1.6 S 1984>1986, Vectra A 2.0 I 1988>1992, Vectra A 2.0 I 4X4 1989>1992, Vectra A Hatch 2.0 I Gt 1988>1995;

PEUGEOT : 204 1.1 1965>1969, 204 1.1 1969>1977, 204 Break 1.1 Grand Luxe 1969>1977, 204 Conversível 1.1 1967>1969, 204 Conversível 1.1 1969>1970, 204 Coupé 1.1 1969>1970, 304 1.3 1972>1975, 304 1.3 Gl 1972>1979, 304 1.3 Gt 1969>1975, 304 Break 1.3 1970>1980, 304 Conversível 1.3 1970>1973, 304 Conversível 1.3 1972>1976, 304 Coupé 1.3 1970>1973, 304 Coupé 1.3 1972>1975, 505 2.2 Turbo Injection 1984>1988;

PROTON: Satria 1.5 2000>2006;

PUCH: G-Modell 230 G 1979>1985;

RENAULT: 11 1.7 1983>1987, 11 1.7 1987>1988, 11 1.7 1986>1988, 11 1.7 1986>1988, 15 1.6 1972>1980, 16 1.6 Ta 1969>1980, 16 1.6 Tx 1974>1980, 17 1.6 1972>1980, 18 1.6 Ts 1982>1986, 18 Variable 1.6 Ts 1982>1986, 19 I 1.7 1988>1992, 19 I 1.7 1988>1992, 19 I 1.7 1988>1992, 19 I Cabriolet 1.7 1991>1992, 19 I Cabriolet 1.7 1991>1992, 19 I Chamade 1.7 1988>1992, 19 I Chamade 1.7 1989>1992, 19 I Chamade 1.7 1988>1992, 19 I Chamade 1.7 1988>1992, 19 li 1.7 1992>1995, 19 li 1.7 1992>1995, 19 li Cabriolet 1.7 1992>1993, 19 li Chamade 1.7 1992>1995, 19 li Chamade 1.7 1992>1995, 19 li Chamade 1.7 1993>1995, 19 li Chamade 1.7 1992>1995, 19 li Chamade 1.7 1992>1995, 20 1.6 1975>1977, 20 1.6 1977>1983, 21 Sw 1.7 1986>1993, 21 Sw 1.7 1986>1988, 21 Sw 1.7 1986>1988, 21 Sw 1.7 1986>1988, 21 Sw 1.7 1987>1989, 21 Sedan 1.7 1986>1987, 21 Sedan 1.7 1986>1993, 21 Sedan 1.7 1989>1994, 21 Sedan 1.7 1986>1994, 21 Sedan 1.7 1986>1994, 21 Sedan 1.7 1986>1994, 21 Sedan 1.7 1987>1989, 9 1.7 1984>1989, 9 1.7 1987>1988, 9 1.7 1986>1988, 9 1.7 1986>1988, Fuego 1.6 Ts/Gts 1980>1985, Super 5 1.7 1987>1995;

ROVER: 800 820 1988>1991, Mini Hatch 1300 1992>2000, Mini Hatch 1300 1992>1995, Mini Hatch 1300 1992>2000;

SAAB: 900 I 2.0 -16 1989>1993, 900 I 2.0 I 1985>1990, 900 I Combi Coupe 2.0 -16 1989>1992, 900 I Combi Coupe 2.0 I 1985>1990, 99 2.0 Ems 1972>1974, 99 Combi Coupe 2.0 Turbo 1977>1980;

SKODA: Felicia I 1.6 Lx 1995>1998, Felicia I Pick-Up 1.6 1997>2002, Felicia I Sw 1.6 Glx 1995>1998, Felicia li 1.6 1998>2001, Felicia li Sw 1.6 1998>2001, Octavia I 1.6 1996>2004, Octavia I Combi 1.6 1998>2004...

CONTINUE...

GV7R42I-10 // NEW //

Pack with 04 Spark Plugs | Paquete con 04 bujías

REPLACES / REEMPLAZA:

NGK: ILZKR7E10DG

APPLICATION / APLICACIÓN:

CITROËN: C3 1.2 2016;

PEUGEOT: 208 1.2 2016>

GV7R43-08 // NEW //

Pack with 04 Spark Plugs | Paquete con 04 bujías

REPLACES / REEMPLAZA:

NGK: KER7A-8DEG

APPLICATION / APLICACIÓN:

VW: Up 1.0 2011>

GV7R44 // NEW //

Pack with 04 Spark Plugs | Paquete con 04 bujías

REPLACES / REEMPLAZA:

NGK: LKR7D-DE

APPLICATION / APLICACIÓN:

HYUNDAI: I10 1.2 2008>2011, I10 1.2 2011>2013, I20 1.2 2008>2012, I20 1.2 2012>2015

GV7R45 // NEW //

Pack with 04 Spark Plugs | Paquete con 04 bujías

REPLACES / REEMPLAZA:

NGK: ZFR7R-G; Denso: KJ22CR-L11; Bosch: F 000 KE0 P28

APPLICATION / APLICACIÓN:

HONDA: Shuttle 2.3 16 V 1997>2004

GV7R46 // NEW //

Pack with 04 Spark Plugs | Paquete con 04 bujías

REPLACES / REEMPLAZA:

NGK: FR7D-DEG

APPLICATION / APLICACIÓN:

VW: Fox 1.0 8v / Totalflex (72cv gas. / 76cv eta. / EA111 TEC.) 2012, Gol 1.0 8v / Totalflex G6 (72cv gas. / 76cv eta. - EA111TEC.) 2012>, Voyage 1.0 8v / Totalflex G6 (72cv gas. / 76cv eta. / EA111 TEC.) 2012>

GV7R49T-10 // NEW //

Pack with 04 Spark Plugs | Paquete con 04 bujías

REPLACES / REEMPLAZA:

NGK: BUR7ETB-10D

APPLICATION / APLICACIÓN:

ALFA ROMEO: 155 (167_) 2.0 16V Turbo Q4 (167.A2B, 167.A2C, 167.A2E) 1992>1997, 155 (167_) 2.0 16V Turbo Q4 (167.A2B, 167.A2C, 167.A2E) 1992>1997;

AUDI: 100 (44, 44Q, C3) 1.8 1986>1988, 100 (44, 44Q, C3) 1.8 1983>1989, 100 (44, 44Q, C3) 1.8 Cat 1985>1990, 100 (44, 44Q, C3) 1.8 Cat Quattro 1985>1990, 100 (44, 44Q, C3) 1.8 Quattro 1986>1990, 100 (44, 44Q, C3) 1.8 Quattro 1984>1988, 100 (44, 44Q, C3) 2.0 1986>1987, 100 (44, 44Q, C3) 2.0 1984>1987, 100 (44, 44Q, C3) 2.0 Cat 1988>1990, 100 (44, 44Q, C3) 2.2 1982>1984, 100 (44, 44Q, C3) 2.2 1984>1986, 100 (44, 44Q, C3) 2.2 1984>1988, 100 (44, 44Q, C3) 2.2 Cat 1989>1990, 100 (44, 44Q, C3) 2.2 Cat Quattro 1989>1990, 100 (44, 44Q, C3) 2.2 E Turbo Quattro 1986>1990, 100 (44, 44Q, C3) 2.2 Turbo 1986>1990, 100 (44, 44Q, C3) 2.2 Quattro 1984>1988, 100 (4A2, C4) 2.0 1990>1994, 100 (4A2, C4) 2.0 E 1990>1994, 100 (4A2, C4) 2.0 E Quattro 1990>1992, 100 Avant (44, 44Q, C3) 1.8 1986>1990, 100 Avant (44, 44Q, C3) 1.8 1983>1989, 100 Avant (44, 44Q, C3) 1.8 Cat 1985>1990, 100 Avant (44, 44Q, C3) 1.8 Cat Quattro 1985>1990, 100 Avant (44, 44Q, C3) 1.8 Quattro 1986>1990, 100 Avant (44, 44Q, C3) 1.8 Quattro 1984>1988, 100 Avant (44, 44Q, C3) 2.0 1986>1987, 100 Avant (44, 44Q, C3) 2.0 E 1985>1987, 100 Avant (44, 44Q, C3) 2.0 E Cat 1988>1990, 100 Avant (44, 44Q, C3) 2.2 1984>1986, 100 Avant (44, 44Q, C3) 2.2 1984>1988, 100 Avant (44, 44Q, C3) 2.2 Cat 1989>1990, 100 Avant (44, 44Q, C3) 2.2 Cat Quattro 1989>1990, 100 Avant (44, 44Q, C3) 2.2 Turbo 1986>1990, 100 Avant (44, 44Q, C3) 2.2 Turbo Quattro 1986>1990, 100 Avant (44, 44Q, C3) 2.2 Quattro 1984>1988, 100 Avant (4A5, C4) 2.0 E 1991>1994, 100 Avant (4A5, C4) 2.0 E 1991>1994, 100 Avant (4A5, C4) 2.0 E Quattro 1990>1992, 200 (43) 2.1 5E 1979>1982, 200 (43) 2.1 5T 1979>1982, 200 (44, 44Q) 2.1 5E 1983>1984, 200 (44, 44Q) 2.1 Turbo 1983>1988, 200 (44, 44Q) 2.1 Turbo Quattro 1983>1986, 200 (44, 44Q) 2.2 1984>1985, 200 (44, 44Q) 2.2 Turbo 1985>1991, 200 (44, 44Q) 2.2 Turbo 1988>1990, 200 (44, 44Q) 2.2 Turbo 1988>1990, 200 (44, 44Q) 2.2 Turbo Quattro 1985>1991, 200 (44, 44Q) 2.2 Turbo Quattro 1988>1990, 200 Avant (44, 44Q) 2.1 Turbo Quattro 1983>1988... CONTINUE



GV7R95T-10

Gasoline - Pack with 04 Spark Plugs | Gasolina - Paquete con 04 bujías

REPLACES / REEMPLAZA:

Bosch: FL5TCR-10, Sp 39, F000 KE0 P39; **Denso:** K22PBR-S10; **NGK:** BKUR7ETB-10

APPLICATION / APLICACIÓN:

SEAT: Ibiza 1.0 16V (AST) 08/00>03;

VW: Gol, Parati 1.0 16V Mi (AT) with distributor 97>07/01, Gol, Parati 2.0 Mi 16V (AP) Gti 97>, Polo Classic 1.0 16V (D3C) 02/01>03;



GV8R01

GNV / Bicombustível (Brazil) - Pack with 04 Spark Plugs | GNV / Bicombustível (Brasil) - Paquete con 04 bujías

REPLACES / REEMPLAZA:

Bosch: WR5C+, Sp32, F000 KE0 P32; **NGK:** BR8ES-D, BR8ES

APPLICATION / APLICACIÓN:

GM: Celta 1.0 8V / VHC Flexpower (70 CV) 05>, Celta 1.0 / VHCE (78 CV alc. / 77 CV Gasoline.) 09>, Classic 1.0 8V / VHCE (77 CV Gasoline. / 78 CV alc.) 04/10>, Corsa 1.0 8V / Flexpower (77 CV Gasoline. / 79 CV alc.) 05>, Corsa 1.0 8V / Flexpower Classic (70 CV Gasoline. / 72 CV alc.) 06>, Onix 1.0 8V / SPE (78CV Gasoline. / 80CV alc.) 10/12>, Prisma 1.0 / VHCE (78 CV alc. / 77 CV Gasoline) 09>



GV8R02

GNV / Bicombustível (Brazil) - Pack with 04 Spark Plugs | GNV / Bicombustível (Brasil) - Paquete con 04 bujías

REPLACES / REEMPLAZA:

Bosch: YR7DE, Sp19, F000 KE0 P19; **NGK:** DCPR8E-N

APPLICATION / APLICACIÓN:

FIAT: Doblò 1.3 16V / Fire 02>, Palio 1.0 16V / Fire - 1.3 16V / Fire 00>, Palio Weekend 1.0 16V / Fire - 1.3 16V / Fire 00>, Siena 1.0 16V / Fire - 1.3 16V / Fire 00>



GV8R09I-10 // NEW //

Gasoline - Pack with 04 IRIIDIUM Spark Plugs | Gasolina - Paquete con 04 bujías IRIIDIUM

REPLACES / REEMPLAZA:

NGK: IZKR8C10D

Fiat/ Jeep: 55247744, 55259565

APPLICATION / APLICACIÓN:

JEEP: Renegade Closed Off-Road Vehicle 1.6 2014>

FIAT: Tipo saloon/hatchback/estate 1.6 2015>, 500X 1.6 2014>

DAIHATSU: Materia 1.3/1.5 2006>



GV8R10P // NEW //

Gasoline - Pack with 04 Spark Plugs | Gasolina - Paquete con 04 bujías

REPLACES / REEMPLAZA:

Jac Motors: 1026106GD171, F8RBPP

APPLICATION / APLICACIÓN:

JAC: J6 2.0 16V 2011>2012, T6 2.0 16V 2015>2016, T8 2.0 2014>2015



GV8R11I // NEW //

Alcohol / Gasoline - Pack with 04 IRIIDIUM Spark Plugs | Alcohol / Gasolina - Paquete con 04 bujías IRIIDIUM

REPLACES / REEMPLAZA:

Jac Motors: 1026080GH012, KL8RBIP

APPLICATION / APLICACIÓN:

JAC: J2 1.4 flex 2014>2015, J3 1.4 flex 2014>2015, J5 1.5 flex 2014>2015, T5 1.5 2016>2017

GV8R11P // NEW //

Pack with 04 Spark Plugs | Paquete con 04 bujías

REPLACES / REEMPLAZA:

NGK: PMR8B; Denso: U24

APPLICATION / APLICACIÓN:

MASERATI: GranSport 4.2 2004>, Quattroporte 4.2 2003>

GV8R12-10 // NEW //

Pack with 04 Spark Plugs | Paquete con 04 bujías

REPLACES / REEMPLAZA:

NGK: ZKR8B-10

APPLICATION / APLICACIÓN:

FIAT: 500 1.4 2011>, Fiorino 1.4 2014>, Grand Siena 1.4 2012>, Grand Siena Tetrafuel 1.4 2011>, Palio 1.4 2011>, Punto 1.4 2012>, Strada 1.4 2017>, Uno 1.4 2010>2016, Uno 1.4 2015>2016

GV8R13 // NEW //

Pack with 04 Spark Plugs | Paquete con 04 bujías

REPLACES / REEMPLAZA:

NGK: DCPR8E; Denso: XU24EPR-U; Magneti Marelli: 062000769304, 062111660312

APPLICATION / APLICACIÓN:

TVR: Cerbera 4.0/ 1999>2003

GV8R31-10 // NEW //

Pack with 04 Spark Plugs | Paquete con 04 bujías

REPLACES / REEMPLAZA:

NGK: ZKR8B10; Bosch: F 000 KE0 P50

APPLICATION / APLICACIÓN:

FIAT: Fiorino Furgão 1.4 >2013, Siena / Grand Siena 1.4 Attractive Flex/1.4 EL Tetrafuel/ 2012>2016, Uno 1.4 Attractive Flex >2010 500 1.4 Evo Cult Dualogic Flex 1.4 Sport Air MT Flex 2011>2017 Palio 1.4 >2010, Punto 1.4 2012>2016

GV8R32I-09 // NEW //

Pack with 04 IRIIDIUM Spark Plugs | Paquete con 04 bujías IRIIDIUM

REPLACES / REEMPLAZA:

NGK: ILMAR8C9D

APPLICATION / APLICACIÓN:

FIAT: Uno 2016>, Argo 2016>, Mobi 2016>

GV8R33I-08 // NEW //

Pack with 04 IRIIDIUM Spark Plugs | Paquete con 04 bujías IRIIDIUM

REPLACES / REEMPLAZA:

NGK: DILKAR8L8D

APPLICATION / APLICACIÓN:

TOYOTA: Corolla 1.8 16v Dual VVT-i / Flex 2013> Corolla 2.0 16v VVT-i / Flex 2010>

**GV9R05I // NEW //****Gasoline - Pack with 04 IRIIDIUM Spark Plugs | Gasolina - Paquete con 04 bujías IRIIDIUM**

REPLACES / REEMPLAZA:

NGK: IKR9F8**Fiat/ Lancia/ Alfa Romeo/ Abarth:** 55210685, 55249868

APPLICATION / APLICACIÓN:

FIAT: Bravo Mk2 hatch 1.4 T-Jet 2007>2014, Bravo Mk2 hatch 1.4 16V 2008>, Doblo Kombi 1.4 Natural Power 2010>, Doblo box body / estate 1.4 Natural Power 2010>, Linea 1.4 T-Jet 2007>, Grande punto 1.4 T-Jet 2007>, Punto evo 1.4 16V 2009>2012, Punto 1.4 Turbo Multi Air 2012>**LANCIA:** Delta Mk3 hatch 1.4 2008>2014**ALFA ROMEO:** Giulietta 1.4 TB 2010>**ABARTH:** 500/595/695 1.4 2008>



COOLING / AIR CONDITIONING | ENFRIAMIENTO / AIRE ACONDICIONADO

RADIATOR COOLING FAN | ELECTROVENTILADOR

GM

GE1001
FEATURES / CARACTERÍSTICAS

Number of blades / Número de aspas: 7
 Motor diameter / Diámetro del motor: 113mm
 Rotation direction / Sentido de rotación: Clockwise / Horario
 Power / Potencia: 300W
 Propeller diameter / Diámetro de la hélice: 360mm
 Air conditioning / Aire acondicionado: with air / con aire

REPLACES / REEMPLAZA:

GM: 93341072

APPLICATION / APLICACIÓN:

GM: Meriva 2006>2013

PEUGEOT

GE1002
FEATURES / CARACTERÍSTICAS

Number of blades / Número de aspas: 6
 Motor diameter / Diámetro del motor: 100mm
 Rotation direction / Sentido de rotación: Clockwise / Horario
 Aspirate or Blow / Aspira o Sopla: Aspirate / Aspira
 Power / Potencia: 165W
 Shaft diameter / Diámetro del eje: 8mm
 Propeller diameter / Diámetro de la hélice: 315mm
 Air conditioning / Aire acondicionado: with air / con aire

REPLACES / REEMPLAZA:

Peugeot: 1253.66; **Citroën:** 1253E9

APPLICATION / APLICACIÓN:

CITROËN: Xsara hatch 1.8i/1.8 16v/2.0 16v 1997>2000, Xsara estate 1.4i/1.6i/1.8i 1997>2005, Berlingo multi space 1.1i 1996>2008, Berlingo van MK1 1.1i/1.4i 1996>2011;

PEUGEOT: 306 Saloon 1.8/2.0 ST 1994>2001, 306 Saloon 1.9 SLD 1994>2001, 306 hatch 1.8 1993>2001

BOSCH

GE1003
FEATURES / CARACTERÍSTICAS

Number of blades / Número de aspas: 6
 Motor diameter / Diámetro del motor: 100mm
 Rotation direction / Sentido de rotación: Clockwise / Horario
 Aspirate or Blow / Aspira o Sopla: Aspirate / Aspira
 Power / Potencia: 170W
 Shaft diameter / Diámetro del eje: 8mm
 Propeller diameter / Diámetro de la hélice: 315mm
 Air conditioning / Aire acondicionado: with air / con aire

REPLACES / REEMPLAZA:

Bosch: 9 130 451 086; **Ford:** 547.959.455F;

VW: 547.959.455E

APPLICATION / APLICACIÓN:

FORD: Escort 1.8/1.8i 1992>1996, Escort 2.0 1992>1996, Escort XR3 1992>1996, Verona 1.6/1.8/1.8i/2.0 1992>1996

VW: Logus 1.6/1.6i/1.8/1.8i/2.0/2.0i 1993>1996, Pointer 1.6/1.8i/2.0/2.0i 1993>1996

FORD

GE1004
FEATURES / CARACTERÍSTICAS

Number of blades / Número de aspas: 4
 Motor diameter / Diámetro del motor: 76mm
 Rotation direction / Sentido de rotación: Clockwise / Horario
 Aspirate or Blow / Aspira o Sopla: Aspirate / Aspira
 Power / Potencia: 70W
 Shaft diameter / Diámetro del eje: 6,5mm x 5,2mm
 Propeller diameter / Diámetro de la hélice: 320mm
 Air conditioning / Aire acondicionado: without air / sin aire

REPLACES / REEMPLAZA:

Ford: 97KB8C607CA

APPLICATION / APLICACIÓN:

FORD: Ka 1.3i 1998>2008, Ka 1.3i 1996<2002, Ka 1.3i 1996>2008, Ka 1.6i 2003>2008

PEUGEOT

GE1005
FEATURES / CARACTERÍSTICAS

Number of blades / Número de aspas: 8
 Motor diameter / Diámetro del motor: 100mm
 Rotation direction / Sentido de rotación: Clockwise / Horario
 Aspirate or Blow / Aspira o Sopla: Aspirate / Aspira
 Power / Potencia: 240W
 Shaft diameter / Diámetro del eje: 6,5mm x 5,2mm
 Propeller diameter / Diámetro de la hélice: 394mm
 Air conditioning / Aire acondicionado: with air / con aire

REPLACES / REEMPLAZA:

Peugeot: 125391 (without support / sin soporte)

APPLICATION / APLICACIÓN:

PEUGEOT: 206 hatch 1.1i/1.4i/1.6i/1.6i 16v/2.0 S16/2.0 RC/1.4 HDI eco 70/1.9D/2.0 HDI 90 eco 70/1.9 D/2.0 HDI 90 1998>2001, 206 SW estate 1.1i/1.4i/1.6 16v/2.0 16v/1.4 Hdi/2.0 Hdi 2002

VW

GE1006
FEATURES / CARACTERÍSTICAS

Number of blades / Número de aspas: 6
 Motor diameter / Diámetro del motor: 100mm
 Rotation direction / Sentido de rotación: Clockwise / Horario
 Aspirate or Blow / Aspira o Sopla: Aspirate / Aspira
 Power / Potencia: 288W
 Shaft diameter / Diámetro del eje: 6mm x 8mm
 Propeller diameter / Diámetro de la hélice: 300mm
 Air conditioning / Aire acondicionado: with air / con aire

REPLACES / REEMPLAZA:

VW: 6K0 959 455A

APPLICATION / APLICACIÓN:

SEAT: Cordoba Mk1 Saloon/Estate 1.4i 1994>1999, Ibiza Mk2 hatch 1.4i 1993>1999, Inca Van 1.4i / 1.9D 1995>2003
VW: Caddy Mk2 Van 60 1.4 1995>2004 / 1.9D 1995>2004, Polo Mk3 Hatch/Van/Saloon/Estate 60 1.4 1995>1999

PEUGEOT

GE1007
FEATURES / CARACTERÍSTICAS

Number of blades / Número de aspas: 8
 Motor diameter / Diámetro del motor: 100mm
 Rotation direction / Sentido de rotación: Clockwise / Horario
 Aspirate or Blow / Aspira o Sopla: Aspirate / Aspira
 Power / Potencia: 240W
 Shaft diameter / Diámetro del eje: 6,5mm x 5,2mm
 Propeller diameter / Diámetro de la hélice: 394mm
 Air conditioning / Aire acondicionado: with air / con aire

REPLACES / REEMPLAZA:

Peugeot: 125391 (with support / con soporte)

APPLICATION / APLICACIÓN:

PEUGEOT: 206 hatch 1.1i/1.4i/1.6i/1.6i 16v/2.0 S16/2.0 RC/1.4 HDI eco 70/1.9D/2.0 HDI 90 eco 70/1.9 D/2.0 HDI 90 1998>2001, 206 SW estate 1.1/1.4/1.6 16v/2.0 16v/1.4 Hdi/2.0 Hdi 2002

RENAULT

GE1008
FEATURES / CARACTERÍSTICAS

Number of blades / Número de aspas: 6
 Motor diameter / Diámetro del motor: 100mm
 Rotation direction / Sentido de rotación: Clockwise / Horario
 Aspirate or Blow / Aspira o Sopla: Aspirate / Aspira
 Power / Potencia: 185W
 Shaft diameter / Diámetro del eje: 8mm
 Propeller diameter / Diámetro de la hélice: 380mm
 Air conditioning / Aire acondicionado: with air / con aire

REPLACES / REEMPLAZA:

Renault: 7 701 070 217

APPLICATION / APLICACIÓN:

RENAULT: Clio MK2 hatch 1.2/1.4/1.5 1998>2009, Kangoo MK1 1.2/1.6/1.9 1997>, Kangoo MK1 Van 1.2/1.5/1.6/1.9 1997>, Mégane MK1 hatch 1.4/1.8/1.9/2.0i 1995>2004, Mégane Classic Saloon 1.4/1.6/1.9/2.0 1996>2008, Mégane MK1 estate 1.4e/1.6e/1.8/1.9 1999>2003, Mégane MK1 coupe 1.4/1.6/1.9/2.0 1996>2003, Mégane convertible 1.4/1.6/2.0 1996>2003, Scenic MK1 1.4i/1.6i/1.9D/2.0i 1996>2001, Thalia I / II 1.5 2001>, Trafic MK2 minibus 1.9D 1997>2001, Trafic MK2 van 1.9D 1997>2001

CITROËN

GE1009
FEATURES / CARACTERÍSTICAS

Number of blades / Número de aspas: 6
 Motor diameter / Diámetro del motor: 101mm
 Rotation direction / Sentido de rotación: Clockwise / Horario
 Power / Potencia: 185W
 Shaft diameter / Diámetro del eje: 8mm
 Propeller diameter / Diámetro de la hélice: 385mm

REPLACES / REEMPLAZA:

Citroën: 1250F8

APPLICATION / APLICACIÓN:

CITROËN: C1 1.0 2005>2014;

PEUGEOT: 406 Saloon/Estate 2.0 Hdi 90 1999>2004 / 2.0 Hdi 110 2001>2004 / 2.0 Hdi 110 1998>2001 / 2.2 Hdi 2000>2004, 607 Saloon 2.0/2.0 Hdi 2000> / 2.2 16v 2000> / 2.2 Hdi 2000> / 3.0 V6 24v 2000>

PEUGEOT

GE1010
FEATURES / CARACTERÍSTICAS

Number of blades / Número de aspas: 5
 Motor diameter / Diámetro del motor: 62mm
 Rotation direction / Sentido de rotación: Counter-Clockwise / Antihorario
 Aspirate or Blow / Aspira o Sopla: Blow / Sopla
 Power / Potencia: 100W
 Shaft diameter / Diámetro del eje: 6,5mm x 5,2mm
 Propeller diameter / Diámetro de la hélice: 340mm
 Air conditioning / Aire acondicionado: without air / sin aire

REPLACES / REEMPLAZA:

Peugeot: 1253.83

APPLICATION / APLICACIÓN:

PEUGEOT: 206 CC convertible 2.0 S16 2000, 206+ 1.1i/1.4i/1.4 Hdi eco 70 2009

BOSCH

GE1011
FEATURES / CARACTERÍSTICAS

Number of blades / Número de aspas: 6
 Motor diameter / Diámetro del motor: 100mm
 Rotation direction / Sentido de rotación: Clockwise / Horario
 Aspirate or Blow / Aspira o Sopla: Aspirate / Aspira
 Power / Potencia: 230W
 Shaft diameter / Diámetro del eje: 8mm
 Propeller diameter / Diámetro de la hélice: 320mm
 Air conditioning / Aire acondicionado: with air / con aire

REPLACES / REEMPLAZA:

Bosch: F 006 KM0 615; **VW:** 377 959 455H

APPLICATION / APLICACIÓN:

VW: Gol II Special 1.0Mi/1.0i, 1.0Mi 8v/16v Special 1.6Mi/1.8i/1.8mi, 2.0Mi/2.0i 16v GTI 1999>2005, Gol III 1.0Mi/ 1.0Mi 16v/ 1.0mi 16v, 1.0mi total flex / 1.6mi/ 1.8mi 2005>2005, Gol IV 1.0/1.0 total flex/1.6/ 1.6 total flex 1.8/ 1.8 total flex, Parati II 1.0mi 16v, Saveiro III 1.6mi/ 1.6mi total flex, Saveiro IV 1.6/ 1.6 total flex, 1.8/1.8 total flex

PEUGEOT

GE1012
FEATURES / CARACTERÍSTICAS

Number of blades / Número de aspas: 6
 Motor diameter / Diámetro del motor: 76mm
 Rotation direction / Sentido de rotación: Clockwise / Horario
 Aspirate or Blow / Aspira o Sopla: Aspirate / Aspira
 Power / Potencia: 288W
 Shaft diameter / Diámetro del eje: 6,5mm x 5,2mm
 Propeller diameter / Diámetro de la hélice: 407mm
 Air conditioning / Aire acondicionado: with air / con aire

REPLACES / REEMPLAZA:

Peugeot: 1253.K7 (without support / sin support)

APPLICATION / APLICACIÓN:

CITROËN: C4 hatch/coupe 1.4 16v/1.6 16v/1.6 Vti 120/1.6 THP 140,150/2.0 16v/1.6 Hdi/2.0 Hdi 2004>2011, C4 saloon 1.6 16v/2.0 16v/1.6 Hdi 2006>2011, C4 picasso/grad picasso MPV 1.6 Vti/1.6 THP 140/1.6 16v/1.6 THP 155/1.8i,2.0i 16v/1.6 Hdi 110/2.0 Hdi 150,165 2007>2013;
PEUGEOT: 307 hatch/estate/sw estate 1.4/1.4 16v/1.6 16v/2.0 16v/1.4 Hdi/1.6 Hdi/2.0 Hdi, 307 cc convertible 1.6,2.0 16v/2.0 Hdi 135 2003>2005

GM

GE1013
FEATURES / CARACTERÍSTICAS

Number of blades / Número de aspas: 4
 Motor diameter / Diámetro del motor: 76mm
 Rotation direction / Sentido de rotación: Clockwise / Horario
 Aspirate or Blow / Aspira o Sopla: Aspirate / Aspira
 Power / Potencia: 155W
 Shaft diameter / Diámetro del eje: 8mm
 Propeller diameter / Diámetro de la hélice: 275mm
 Air conditioning / Aire acondicionado: without air / sin aire
 PS. 4 PULSE / equal to GS1004 (8 pulse)

REPLACES / REEMPLAZA:

Bosch: 9 130 451 171; **GM:** 90.920.012; **Valeo:** 698.637R

APPLICATION / APLICACIÓN:

GM: Corsa 1.0 EFI / 1.0 MPFI / 1.0 MPFI 16V / 1.3 MPFI / 1.4 EFI / MPFI / 1.6 MPFI 16V / 1.6 GSI SFI 16V 94>02, Corsa Pickup 1.6 EFI / 1.6 MPFI 95>03, Corsa Sedan 1.0 MPFI / 1.0 MPFI 16V / 1.0 VHC / 1.6 MPFI 16V 00>00, Corsa Wagon 1.0 MPFI 16V / MPFI 16V 96>02

CITROËN

GE1014
FEATURES / CARACTERÍSTICAS

Number of blades / Número de aspas: 6
 Motor diameter / Diámetro del motor: 76mm
 Rotation direction / Sentido de rotación: Clockwise / Horario
 Aspirate or Blow / Aspira o Sopla: Aspirate / Aspira
 Power / Potencia: 288W
 Shaft diameter / Diámetro del eje: 6,5mm x 5,2mm
 Propeller diameter / Diámetro de la hélice: 407mm
 Air conditioning / Aire acondicionado: with air / con aire

REPLACES / REEMPLAZA:

Citroën/ Peugeot: 1253.K7, 1253.K2; **Peugeot:** 542959455B (with support / con soporte)

APPLICATION / APLICACIÓN:

CITROËN: C4 hatch/coupe 1.4 16v/1.6 16v/1.6 Vti 120/1.6 THP 140,150/2.0 16v/1.6 Hdi/2.0 Hdi 2004>2011, C4 saloon 1.6 16v/2.0 16v/1.6 Hdi 2006>2011, C4 picasso/grad picasso MPV 1.6 Vti/1.6 THP 140/1.6 16v/1.6 THP 155/1.8i,2.0i 16v/1.6 Hdi 110/2.0 Hdi 150,165 2007>2013
PEUGEOT: 307 hatch/estate/sw estate 1.4/1.4 16v/1.6 16v/2.0 16v/1.4 Hdi/1.6 Hdi/2.0 Hdi, 307 cc convertible 1.6,2.0 16v/2.0 Hdi 135 2003>2005

VALEO

GE1015
FEATURES / CARACTERÍSTICAS

Number of blades / Número de aspas: 5
 Motor diameter / Diámetro del motor: 100mm
 Rotation direction / Sentido de rotación: Clockwise / Horario
 Aspirate or Blow / Aspira o Sopla: Aspirate / Aspira
 Power / Potencia: 260W
 Shaft diameter / Diámetro del eje: 8mm
 Propeller diameter / Diámetro de la hélice: 322mm
 Air conditioning / Aire acondicionado: without air / sin aire - with air / con aire

REPLACES / REEMPLAZA:

Fiat: 46.449.102, 46.449.130, 46.764.671, 46.782.466, 46.782.468; **Valeo:** 4EV015A, 4EV016A, 698845R

APPLICATION / APLICACIÓN:

FIAT: Fiorino Fire 1.0/1.3 8v (without air) 2001>2007, Palio 1.0/1.5 8v/16v 1996>2001, Siena 1.0/1.5/1.6 8v/16v 1996>2001, Strada 1.0/1.5/1.6 8v/16v (without air) 1996>2001, Uno Mille Fire 1.0/1.3 8v gasoline with air 2001>2007

VALEO

GE1016
FEATURES / CARACTERÍSTICAS

Number of blades / Número de aspas: 5
 Motor diameter / Diámetro del motor: 62mm
 Rotation direction / Sentido de rotación: Clockwise / Horario
 Aspirate or Blow / Aspira o Sopla: Aspirate / Aspira
 Power / Potencia: 100W
 Propeller diameter / Diámetro de la hélice: 322mm
 Air conditioning / Aire acondicionado: without air / sin aire

REPLACES / REEMPLAZA:

Fiat: 46.449.099, 46.764.670, 46.782.467; **Valeo:** 4EV014A

APPLICATION / APLICACIÓN:

FIAT: Palio weekend estate 1.2 1996>2001, Palio weekend estate 1.6 16v 1996>2001, Strada pickup 1.2 1999>2006

VALEO

GE1017
FEATURES / CARACTERÍSTICAS

Number of blades / Número de aspas: 11
 Motor diameter / Diámetro del motor: 100mm
 Rotation direction / Sentido de rotación: Clockwise / Horario
 Aspirate or Blow / Aspira o Sopla: Blow / Sopla
 Power / Potencia: 160W
 Shaft diameter / Diámetro del eje: 8mm x 6mm
 Propeller diameter / Diámetro de la hélice: 345mm
 Air conditioning / Aire acondicionado: with air / con aire

REPLACES / REEMPLAZA:

Valeo: 4EV012A

APPLICATION / APLICACIÓN:

FORD: Courier 1.0/1.6 (Zetec Rocam) 99>07, Fiesta 1.0/1.6 (Zetec Rocam) 1999>2004

PEUGEOT

GE1018
FEATURES / CARACTERÍSTICAS

Number of blades / Número de aspas: 8
 Motor diameter / Diámetro del motor: 76mm
 Rotation direction / Sentido de rotación: Clockwise / Horario
 Aspirate or Blow / Aspira o Sopla: Aspirate / Aspira
 Power / Potencia: 250W
 Shaft diameter / Diámetro del eje: 5,2mm x 6,5mm
 Propeller diameter / Diámetro de la hélice: 394mm
 Air conditioning / Aire acondicionado: with air / con aire

REPLACES / REEMPLAZA:

Peugeot: 1253.C9, 1253.R7, 9643386780

APPLICATION / APLICACIÓN:

PEUGEOT: 206 hatch 1.1/1.4i/2.0S16/1.9D, 206 sallon 1.4/1.6 16v/1.4 Hdi eco 70 2007, 206 sw estate 1.1/1.4/1.4 16v/1.6 16v/2.0 16v/1.4 Hdi 2002

BOSCH

GE1019
FEATURES / CARACTERÍSTICAS

Number of blades / Número de aspas: 5
 Motor diameter / Diámetro del motor: 100mm
 Rotation direction / Sentido de rotación: Clockwise / Horario
 Aspirate or Blow / Aspira o Sopla: Aspirate / Aspira
 Power / Potencia: 252W
 Shaft diameter / Diámetro del eje: 8mm
 Propeller diameter / Diámetro de la hélice: 305mm
 Air conditioning / Aire acondicionado: with air / con aire

REPLACES / REEMPLAZA:

Bosch: 0 130 303 244, F 006 KM0 609; **GM:** 1341307, 1341258, 90510209, 09117716

APPLICATION / APLICACIÓN:

OPEL: Combo 1.4 1994>2001, Corsa B hatch 1.4i/1.4i 16v/1.6i 16v/ 1.6 GSI 16v/1.5 TD/1.7 D 1993>2000, Corsa B estate 1.4i 16v 1999>2002, Corsa B van 1.4i/1.7 D 1999>2000, Tigra 1.4 16v/1.6 16v 1994>2000

BOSCH

GE1020
FEATURES / CARACTERÍSTICAS

Number of blades / Número de aspas: 5
 Motor diameter / Diámetro del motor: 76mm
 Rotation direction / Sentido de rotación: Clockwise / Horario
 Aspirate or Blow / Aspira o Sopla: Aspirate / Aspira
 Power / Potencia: 288W
 Shaft diameter / Diámetro del eje: 6mm x 8mm
 Propeller diameter / Diámetro de la hélice: 300mm
 Air conditioning / Aire acondicionado: with air / con aire

REPLACES / REEMPLAZA:

Bosch: 9 130 451 215, 9 130 451 216; **VW:** 325.121.207.2CTR

APPLICATION / APLICACIÓN:

VW: Quantum 1.8/1.8i/1.8Mi/2.0/2.0i/2.0mi 1991>2001, Santana 1.8/ 1.8i/ 1.8mi/2.0/2.0i/2.0mi 1996>2006

BOSCH

GE1021
FEATURES / CARACTERÍSTICAS

Number of blades / Número de aspas: 6
 Motor diameter / Diámetro del motor: 100mm
 Rotation direction / Sentido de rotación: Clockwise / Horario
 Aspirate or Blow / Aspira o Sopla: Aspirate / Aspira
 Power / Potencia: 210W
 Shaft diameter / Diámetro del eje: 8mm
 Propeller diameter / Diámetro de la hélice: 306mm
 Air conditioning / Aire acondicionado: with air / con aire

REPLACES / REEMPLAZA:

Bosch: F 006 KMO 609; **GM:** 93294288

APPLICATION / APLICACIÓN:

CHEVROLET: Corsa 1.6 MPFI 16v 1996>2002, Corsa 1.6i GLS 1994>1994, Corsa Pickup 1.6 MPFI 1995>2003, Corsa Sedan 1.6 MPFI 16v 1995>2002, Corsa Wagon 1.6 MPFI 16v 1997>2002

VW

GE1022
FEATURES / CARACTERÍSTICAS

Number of blades / Número de aspas: 9
 Motor diameter / Diámetro del motor: 76mm
 Rotation direction / Sentido de rotación: Clockwise / Horario
 Aspirate or Blow / Aspira o Sopla: Aspirate / Aspira
 Power / Potencia: 55W
 Shaft diameter / Diámetro del eje: 8mm
 Propeller diameter / Diámetro de la hélice: 291mm
 Air conditioning / Aire acondicionado: with air / con aire

REPLACES / REEMPLAZA:

VW: 1J0 959 455P

APPLICATION / APLICACIÓN:

SKODA: Octavia MK1 hatch/estate 1.4 16v/1.6 2000>2010, Octavia MK2 hatch 1.4/1.6 2004>2013, Octavia MK2 estate 1.6 2004>2013

VW: Bora Saloon 1.4 16v/1.6 16v/1.6 FSI 2000>2005, Bora estate 1.4 16v/1.6 16v 2000>2005, Golf MK4 hatch 1.6 FSI 2002>2005, Golf MK5 hatch 1.4 16v 2003>2006

VALEO

GE1023
FEATURES / CARACTERÍSTICAS

Number of blades / Número de aspas: 11
 Motor diameter / Diámetro del motor: 100mm
 Rotation direction / Sentido de rotación: Clockwise / Horario
 Aspirate or Blow / Aspira o Sopla: Blow / Sopla
 Power / Potencia: 160W
 Shaft diameter / Diámetro del eje: 8mm x 6mm
 Propeller diameter / Diámetro de la hélice: 345mm
 Air conditioning / Aire acondicionado: with air / con aire

REPLACES / REEMPLAZA:

Valeo: 698672R, 698673R; **Ford:** 2S65-8K620-DA

APPLICATION / APLICACIÓN:

FORD: Fiesta 1.0 (supercharger) 2002>2005, Fiesta 1.0/1.4/1.6 (Zetec Rocam) 2002>2007

FIAT

GE1024
FEATURES / CARACTERÍSTICAS

Number of blades / Número de aspas: 7
 Motor diameter / Diámetro del motor: 100mm
 Rotation direction / Sentido de rotación: Clockwise / Horario
 Aspirate or Blow / Aspira o Sopla: Aspirate / Aspira
 Power / Potencia: 228W
 Propeller diameter / Diámetro de la hélice: 390mm
 Air conditioning / Aire acondicionado: with air / con aire

REPLACES / REEMPLAZA:

Fiat: 46816876, 46816877, 46816879; **GM:** 9.158.007

APPLICATION / APLICACIÓN:

FIAT: Idea 1.6/1.8, Palio Fire 1.3/1.4/1.5/1.6 2001->, Strada Fire 1.3/1.4/1.5/1.6 2001>

GM: GM models

FIAT

GE1025
FEATURES / CARACTERÍSTICAS

Number of blades / Número de aspas: 7
 Motor diameter / Diámetro del motor: 62mm
 Rotation direction / Sentido de rotación: Clockwise / Horario
 Aspirate or Blow / Aspira o Sopla: Aspirate / Aspira
 Power / Potencia: 100W
 Shaft diameter / Diámetro del eje: 5,2mm x 6,5mm
 Propeller diameter / Diámetro de la hélice: 335mm
 Air conditioning / Aire acondicionado: without air / sin aire

REPLACES / REEMPLAZA:

Fiat: 51822633

APPLICATION / APLICACIÓN:

FIAT: Palio 1.0/1.3/1.4/1.5 2001>, Strada Fire 1.3/1.4/1.5/1.6 2001>, Uno 1.0 2001>

GM: GM models

FIAT

GE1026
FEATURES / CARACTERÍSTICAS

Number of blades / Número de aspas: 5
 Motor diameter / Diámetro del motor: 100mm
 Rotation direction / Sentido de rotación: Clockwise / Horario
 Aspirate or Blow / Aspira o Sopla: Aspirate / Aspira
 Power / Potencia: 260W
 Propeller diameter / Diámetro de la hélice: 322mm
 Air conditioning / Aire acondicionado: with air / con aire - without air / sin aire

REPLACES / REEMPLAZA:

Fiat: 46815898, 46815901, 46832896; **GM:** 93337578

APPLICATION / APLICACIÓN:

FIAT: Palio (RST) 1.0/1.3 8V/16V (Fire)/ 1.5 8V (Fire)/1.6 8V/16V/1.8 8V 2002>2008, Palio Weekend (RST) 1.0/1.3 16V (Fire) 2000>2003, Palio Weekend (RST) 1.3/1.5/1.6 8V (Fire)/ 1.8 8V 2002>2008, Siena (RST) 1.0/1.3 8V/16V (Fire)/1.6 8V/16V 2002>2008, Siena (RST) 1.6 8V (Fire) 2002>2004, Strada (RST) 1.3/1.5 8V/16V (Fire)/1.6 8V/16V/1.8 8V 2002>2008

GM: Celta 1.0/1.4 8V VHC (flex) 2006>2008, Prisma 1.0/1.4 8V VHC (flex) 2006>2008

VALEO

GE1027
FEATURES / CARACTERÍSTICAS

Number of blades / Número de aspas: 6
 Motor diameter / Diámetro del motor: 101mm
 Rotation direction / Sentido de rotación: Clockwise / Horario
 Power / Potencia: 300W
 Propeller diameter / Diámetro de la hélice: 322mm
 Air conditioning / Aire acondicionado: with air / con aire

REPLACES / REEMPLAZA:

Citroën: 1253.C6, 1253.H3; **Valeo:** 696133

APPLICATION / APLICACIÓN:

CITROËN: C2 1.1/1.4/1.4 16v/1.6/1.6 VTS 2003, C3 1.1i/1.4i/1.4 16v/1.6 16v/1.4 16v HDi/ 1.6 16v HDi 2002>2005

PEUGEOT: 207 hatch 1.4/1.4 16v/1.6 16v/1.6 16v Vti/1.6 16v turbo 2006>2009, 207 CC Convertible 1.6 16v/1.6 16v turbo 2007, 207 SW Estate 1.4/1.4 16v/1.6 16v/1.6 16v turbo 2007, 1007 1.4/1.4 16v/1.6 16v 2005

VW

GE1028
FEATURES / CARACTERÍSTICAS

Number of blades / Número de aspas: 7
 Motor diameter / Diámetro del motor: 79mm
 Rotation direction / Sentido de rotación: Counter-Clockwise / Antihorario
 Aspirate or Blow / Aspira o Sopla: Aspirate / Aspira
 Power / Potencia: 250/60W
 Shaft diameter / Diámetro del eje: 10mm x 5,5mm
 Propeller diameter / Diámetro de la hélice: 345mm
 Air conditioning / Aire acondicionado: without air / sin aire

REPLACES / REEMPLAZA:

VW: 1J0 959 455D/F, 6Q0 959 455L/A/F

APPLICATION / APLICACIÓN:

SKODA: Fabia MK1 hatch 1.4/1.9 SDI 1999>2008, Fabia MK1 saloon 1.4/1.9 SDI 1999>2007, Fabia MK1 estate 1.4/1.9 SDI 2000>2007, Fabia MK1 van 1.4/1.9 SDI 2001>2007, Octavia MK1 hatch 1.6/1.9 TDI 1996>2010, Octavia MK1 estate 1.6/1.9 TDI 1998>2010

VW: Bora saloon/estate/ 1.6/1.8/1.9 TDI 1998>2005, Golf MK4 hatch/estate 1.6/1.8/1.9 1998>2005

VW

GE1029
FEATURES / CARACTERÍSTICAS

Number of blades / Número de aspas: 7
 Motor diameter / Diámetro del motor: 100mm
 Rotation direction / Sentido de rotación: Clockwise / Horario
 Aspirate or Blow / Aspira o Sopla: Aspirate / Aspira
 Power / Potencia: 250/60W
 Shaft diameter / Diámetro del eje: 6,5mm x 5,2mm
 Propeller diameter / Diámetro de la hélice: 345mm
 Air conditioning / Aire acondicionado: with air / con aire

REPLACES / REEMPLAZA:

VW: 1J0959455S, 6Q0959 455, 6Q0959 455Q, 6Q0959 455C, 6Q0959 455H

APPLICATION / APLICACIÓN:

VW: Bora Saloon/Estate 1.8T/2.3 V5/2.8 V6/1.9 TDI 1998>2005, Golf MK4 Estate 1.8T/2.3 V5/2.8 V6 1999>2006, New Beetle 1.8T 2001>2005

AUDI: A3 MK1 hatch 1.8T 1996>2003, TT Coupe MK1 3.2 VR6 quattro 1998>2006, TT Roadster Cabrio MK1 3.2 VR6 quattro 2003>2006

VW

GE1030
FEATURES / CARACTERÍSTICAS

Number of blades / Número de aspas: 9
 Motor diameter / Diámetro del motor: 100mm
 Rotation direction / Sentido de rotación: Counter-Clockwise / Antihorario
 Aspirate or Blow / Aspira o Sopla: Aspirate / Aspira
 Power / Potencia: 220/60W
 Shaft diameter / Diámetro del eje: 8mm
 Propeller diameter / Diámetro de la hélice: 290mm
 Air conditioning / Aire acondicionado: with air / con aire

REPLACES / REEMPLAZA:

VW: 1J0 959 455M/C/K, 6Q0 959 455L/P/C, 1C0 959 455C; **Magneti Marelli:** 9144601MM

APPLICATION / APLICACIÓN:

AUDI: A3 MK1 hatch 1.6/1.8/S3 quattro/1.9 Tdi 1996>2003, TT coupe MK1 1.8T/1.8T quattro 1998>2006, TT roadster cabrio MK1 1.8T/1.8T quattro

SEAT: Leon MK1 hatch 1.4 16v/1.6/1.8 20v/1.9 Sdi 1999>2006, Toledo MK2 saloon 1.4 16v/1.6/1.8 20v/2.3 V5/1.9 Tdi 1998>2004

SKODA: Fabia MK1 hatch 1.0/1.4 1999>2003, Octavia MK1 hatch/estate 1.6/1.8/1.8T/2.0/1.9 SDi

VW: Bora saloon 1.6/1.8 1998>2005, Bora estate 1.6/1.8/2.0/2.3/1.9 TDi, Golf MK4 hatch/estate 1.4/1.6/1.8/2.0/2.3/1.9 TDi, New beetle 1.6/2.0/1.9 TDi 1998>2010

VW

GE1031
FEATURES / CARACTERÍSTICAS

Number of blades / Número de aspas: 9
 Motor diameter / Diámetro del motor: 100mm
 Rotation direction / Sentido de rotación: Clockwise / Horario
 Aspirate or Blow / Aspira o Sopla: Blow / Sopla
 Power / Potencia: 100W
 Propeller diameter / Diámetro de la hélice: 290mm
 Air conditioning / Aire acondicionado: with air / con aire

REPLACES / REEMPLAZA:

VW: 6Q0 959 455J, 6QD 959 455B

APPLICATION / APLICACIÓN:

SEAT: Cordoba MK1 hatch 1.4 16v 2000>2002, Cordoba MK2 saloon 1.2/1.4/1.6/1.9 2002>2009, Ibiza MK3 hatch 1.4 16v 1999>2002, Ibiza MK4 1.2/1.4/1.6/1.8/1.9 2002>2009

VW: Fox hatch 1.4 2005, Polo MK3 hatch 1.4 16v 1999>2001, Polo MK4 1.2/1.4/1.9 2001>2012, Polo MK4 saloon 1.4/1.9 SDi

VW

GE1032
FEATURES / CARACTERÍSTICAS

Number of blades / Número de aspas: 7
 Motor diameter / Diámetro del motor: 101mm
 Rotation direction / Sentido de rotación: Clockwise / Horario
 Aspirate or Blow / Aspira o Sopla: Aspirate / Aspira
 Power / Potencia: 250W
 Shaft diameter / Diámetro del eje: 8mm
 Propeller diameter / Diámetro de la hélice: 392mm
 Air conditioning / Aire acondicionado: with air / con aire

REPLACES / REEMPLAZA:

VW: 5U0 959 455B

APPLICATION / APLICACIÓN:

VW: Fox 1.0L / 1.6L 2007>, Gol GV 1.0L / 1.6L 2008>, Golf 1.6L 2006>2012, Polo 1.6L 2006>2012, Saveiro GV 1.0L / 1.6L 08>, Voyage GV 1.0L / 1.6L 08>, Space Fox 06>VW: Fox hatch 1.4 2005, Polo MK3 hatch 1.4 16v 1999>2001, Polo MK4 1.2/1.4/1.9 2001>2012, Polo MK4 saloon 1.4/1.9 SDi

VW

GE1033
FEATURES / CARACTERÍSTICAS

Number of blades / Número de aspas: 7
 Motor diameter / Diámetro del motor: 82mm
 Rotation direction / Sentido de rotación: Clockwise / Horario
 Aspirate or Blow / Aspira o Sopla: Aspirate / Aspira
 Power / Potencia: 90W
 Shaft diameter / Diámetro del eje: 8mm
 Propeller diameter / Diámetro de la hélice: 390mm
 Air conditioning / Aire acondicionado: without air / sin aire

REPLACES / REEMPLAZA:

VW: 5U0 959 455A

APPLICATION / APLICACIÓN:

VW: Fox 1.6, Gol GV 1.6, Saveiro GV 1.6, Voyage GV 1.6

DENSO

GE1034
FEATURES / CARACTERÍSTICAS

Number of blades / Número de aspas: 9
 Motor diameter / Diámetro del motor: 100mm
 Rotation direction / Sentido de rotación: Clockwise / Horario
 Power / Potencia: 300W
 Propeller diameter / Diámetro de la hélice: 405mm
 Air conditioning / Aire acondicionado: with air / con aire

REPLACES / REEMPLAZA:

GM: 94733314; **Denso:** BC422750-8212

APPLICATION / APLICACIÓN:

GM: Onix 1.0/1.4 2012>, Prisma 1.0/1.4 2013>, Sonic 1.4 2012>

DENSO



GE1035

FEATURES / CARACTERÍSTICAS

Number of blades / Número de aspas: 10
 Motor diameter / Diámetro del motor: 100mm
 Rotation direction / Sentido de rotación: Clockwise / Horario
 Power / Potencia: 300W
 Propeller diameter / Diámetro de la hélice: 365mm
 Air conditioning / Aire acondicionado: with air / con aire

REPLACES / REEMPLAZA:

Denso: M15001600; **Fiat:** 51835572, 51905874

APPLICATION / APLICACIÓN:

FIAT: Fiorino Furgão 1.4 Evo Flex 16>, Grand Siena Attractive 1.4 Mpi Fire 8v Flex 13>15, Mobi 1.0 fire 8v 17>, Novo Uno attractive 1.4 flex 10>, Novo Uno vivace 1.0 flex 10>, Novo Uno way 1.0/1.4 flex 10>, Palio Attractive 1.0/1.4 mpi Fire 12>15

BOSCH



GE1036

FEATURES / CARACTERÍSTICAS

Number of blades / Número de aspas: 5
 Motor diameter / Diámetro del motor: 76mm
 Rotation direction / Sentido de rotación: Clockwise / Horario
 Aspirate or Blow / Aspira o Sopla: Aspirate / Aspira
 Power / Potencia: 160W
 Shaft diameter / Diámetro del eje: 8mm

Propeller diameter / Diámetro de la hélice: 296mm

Air conditioning / Aire acondicionado: without air / sin aire

REPLACES / REEMPLAZA:

Bosch: 9 130 451 137, 9 130 451 141

APPLICATION / APLICACIÓN:

FORD: Escort 1.6 / 1.6i / 1.8 / 1.8i 92>96, Verona 1.6 / 1.8 / 1.8i 90>91
VW: Gol II 1.0i / 1.0Mi / 1.0 Mi 8V / 1.0 Mi 16 V / 1.6Mi / Gol II 1.8Mi / Gol II 2.0i / Gol II 2.0Mi 16V GTI 94>05, Logus 1.6/1.6i/1.8/1.8i/2.0/2.0i 93>96, Parati II 1.0Mi 16V / 1.6i / 1.6Mi / 1.8 / 1.8 Mi / 2.0i / 2.0 Mi / 1.9 D / GTI 2.0 Mi 16V 95>99, Pointer 1.8/1.8i/2.0/2.0i 93>96, Saveiro II 1.6Mi / 1.8Mi / 2.0Mi 97> 00

HONDA



GE1037

FEATURES / CARACTERÍSTICAS

Number of blades / Número de palas: 5
 Motor diameter / Diámetro del motor: 105mm
 Rotation sense / Sentido de rotación: Counter-Clockwise / Antihorario
 Power / Poder: 120W
 Propeller diameter / Diámetro de la hélice: 285mm

Air conditioning / Aire acondicionado: with air / con aire

REPLACES / REEMPLAZA:

HONDA: 19030RB6Z11, 19030PAAA01

APPLICATION / APLICACIÓN:

HONDA: Civic MK6 hatch 1.4i/1.6i/1.7i 2001>2005, Civic MK6 saloon 1.4/1.6 2000>2005, Civic Mk6 coupe 1.6i/1.7i 2001>2005

BOSCH



GE1038

FEATURES / CARACTERÍSTICAS

Number of blades / Número de palas: 5
 Motor diameter / Diámetro del motor: 102mm
 Rotation direction / Sentido de rotación: Clockwise / Horario
 Power / Potencia: 335W
 Propeller diameter / Diámetro de la hélice: 330mm

Air conditioning / Aire acondicionado: with air / con aire

REPLACES / REEMPLAZA:

Bosch: F 006 B10 064; **Fiat:** 51745932

APPLICATION / APLICACIÓN:

FIAT: Palio 1.8 MPI 8V 2003>, Palio 1.8 MPI 8V Flex 2003>, Palio 1.8 R MPI 8V 2003>, Palio 1.8 R MPI 8V Flex 2003>, Palio Weekend 1.8 MPI 8V 2004>, Palio Weekend Adventure 1.8 MPI 8V >2004, Siena 1.8 MPI 8V 2003>, Siena 1.8 MPI 8V Flex 2003>

TOYOTA



GE1039 // NEW //

FEATURES / CARACTERÍSTICAS

Number of blades / Número de palas: 5
 Motor diameter / Diámetro del motor: 103mm
 Rotation direction / Sentido de rotación: Counter-Clockwise / Antihorario
 Power / Potencia: 103W
 Propeller diameter / Diámetro de la hélice: 360mm

Air conditioning / Aire acondicionado: with air / con aire

REPLACES / REEMPLAZA:

TOYOTA: 16361-0D110, 16363-28160

APPLICATION / APLICACIÓN:

TOYOTA: Corolla hatch 1.4/1.6/1.8 2002>2007, Corolla saloon 1.4/1.6 2001>2007, Corolla estate 1.4/1.6 2002>2007, Corolla verso MK1 1.6/1.8 2001>2004

BOSCH

GE1040
FEATURES / CARACTERÍSTICAS

Number of blades / Número de palas: 4
 Motor diameter / Diámetro del motor: 79mm
 Rotation direction / Sentido de rotación: Clockwise / Horario
 Aspirate or Blow / Aspira o Sopla: Aspirate / Aspira
 Power / Potencia: 74W
 Shaft diameter / Diámetro del eje: 8mm
 Propeller diameter / Diámetro de la hélice: 280mm
 Air conditioning / Aire acondicionado: without air / sin aire

REPLACES / REEMPLAZA:

Bosch: 9 130 081 032, 9 130 081 066, 9 130 081 090

APPLICATION / APLICACIÓN:

VOLKSWAGEN: Apollo 1.8 1990>1992, Gol I 1.0/1.6/1.6D/1.8/2.0 GTI 1984>1994, Parati I 1.6/1.6D/1.8 1989>1995, Quantum 1.8/2.0 1985>1991, Saveiro I 1.6/1.6MI/1.8/1.8MI 1989>1997, Voyage 1.6/1.8/1.8 Special 1989>1995

RENAULT

GE1041 // NEW //
FEATURES / CARACTERÍSTICAS

Number of blades / Numero de aspas: 10
 Motor diameter / Diámetro del motor: 100mm
 Rotation direction / Sentido de rotación: Horário
 Aspirate or Blow / Aspira o Sopla: Blow / Sopla
 Power / Potencia: 160W
 Shaft diameter / Diámetro do eixo: 8mm
 Propeller diameter / Diámetro de la hélice: 320 mm
 Air conditioning / Aire acondicionado: with / without

REPLACES / REEMPLAZA:

Renault: 7700750157

APPLICATION / APLICACIÓN:

RENAULT: 18 1978>1986, Fuego 1980>1992

HONDA

GE1042
FEATURES / CARACTERÍSTICAS

Number of blades / Número de palas: 5
 Motor diameter / Diámetro del motor: 70mm
 Rotation sense / Sentido de rotación: Clockwise / Horario
 Power / Poder: 65W
 Propeller diameter / Diámetro de la hélice: 270mm
 Air conditioning / Aire acondicionado: with air / con aire

REPLACES / REEMPLAZA:

HONDA: 19020PL6003, 19030PWHM01

APPLICATION / APLICACIÓN:

HONDA: Fit 1.4, 1.5 2003>2008

HONDA

GE1043
FEATURES / CARACTERÍSTICAS

Number of blades / Número de palas: 5
 Motor diameter / Diámetro del motor: 75mm
 Rotation sense / Sentido de rotación: Clockwise / Horario
 Power / Poder: 100W
 Propeller diameter / Diámetro de la hélice: 310mm
 Air conditioning / Aire acondicionado: with air / con aire

REPLACES / REEMPLAZA:

HONDA: 19020RRAA01

APPLICATION / APLICACIÓN:

HONDA: City 1.5 flex 2009>2016, Fit 1.4 flex 2009>2016, Fit 1.5 flex 2009>2016

DENSO

GE1044 // NEW //
FEATURES / CARACTERÍSTICAS

Number of blades / Número de palas: 5
 Motor diameter / Diámetro del motor: 101mm
 Rotation sense / Sentido de rotación: Counter-Clockwise / Antihorario
 Power / Poder: 80W
 Propeller diameter / Diámetro de la hélice: 376mm
 Air conditioning / Aire acondicionado: with air / con aire
 Ps.: with deflector/ con deflector

REPLACES / REEMPLAZA:

DENSO: 16363-0T020; **TOYOTA:** 16361-0D240 (propeller), 16363-22120 (engine)

APPLICATION / APLICACIÓN:

TOYOTA: Corolla 1.8/2.0 16v 2009>2014

TOYOTA



GE1045 // NEW //

FEATURES / CARACTERÍSTICAS

Number of blades / Número de palas: 5
 Motor diameter / Diámetro del motor: 101mm
 Rotation sense / Sentido de rotación: Counter-Clockwise / Antihorario
 Power / Poder: 80W
 Propeller diameter / Diámetro de la hélice: 376mm
 Air conditioning / Aire acondicionado: with air / con aire

REPLACES / REEMPLAZA:

TOYOTA: 16361-0D240, 16363-22120

APPLICATION / APLICACIÓN:

TOYOTA: Auris hatch 1.3/1.4/1.6/1.8 2007>2012

BOSCH



GE1046

FEATURES / CARACTERÍSTICAS

Number of blades / Número de palas: 6
 Motor diameter / Diámetro del motor: 100mm
 Rotation direction / Sentido de rotación: Clockwise / Horario
 Aspirate or Blow / Aspira o Sopla: Aspirate / Aspira
 Power / Potencia: 290W
 Shaft diameter / Diámetro del eje: 10mm
 Propeller diameter / Diámetro de la hélice: 306mm
 Air conditioning / Aire acondicionado: without air / sin aire

REPLACES / REEMPLAZA:

Bosch: 9 130 451 106

APPLICATION / APLICACIÓN:

FIAT: Elba 1.5 SPI/1.6/1.6 MPI/1.6 SPI 1990>1996, Fiorino Furgão/Pick-up 1.0/1.0 SPI/1.3/1.5 1990>2004, Furgoneta 1.5 MPI 8V 1990>2003, Mille 1.0 MPI 1990>2003, Prêmio 1.5/1.5 SPI/1.6/1.6 SPI 1989>1994, Uno 1.3 MPI/1.4 MPI (diesel)/1.5 SPI/1.6/1.6 MPI/1.6 R (MPI)/1.7D 1990>2003

BOSCH



GE1047 // NEW //

FEATURES / CARACTERÍSTICAS

Number of blades / Numero de aspas: 10
 Motor diameter / Diámetro del motor: 100mm
 Aspirate or Blow / Aspira o Sopla: Blow / Sopla
 Shaft diameter / Diámetro do eixo: 8mm
 Power / Potencia: 155W
 Propeller diameter / Diámetro de la hélice: 325 mm
 Air conditioning / Aire acondicionado: With/Without

REPLACES / REEMPLAZA:

Renault: 7700672003

APPLICATION / APLICACIÓN:

RENAULT: Espace I 1984>1988, 21 1986>1994

BOSCH



GE1048

FEATURES / CARACTERÍSTICAS

Number of blades / Número de palas: 6
 Motor diameter / Diámetro del motor: 100mm
 Rotation direction / Sentido de rotación: Clockwise / Horario
 Aspirate or Blow / Aspira o Sopla: Aspirate / Aspira
 Power / Potencia: 230W
 Shaft diameter / Diámetro del eje: 8mm
 Propeller diameter / Diámetro de la hélice: 306mm
 Air conditioning / Aire acondicionado: without air / sin aire

REPLACES / REEMPLAZA:

Bosch: 9 130 451 046; **Fiat:** 7519723

APPLICATION / APLICACIÓN:

FIAT: Elba 1.5 SPI/1.6/1.6 MPI/1.6 SPI 1990>1996, Fiorino Furgão/Pick-up 1.0/1.0 SPI/1.3/1.5 1990>2004, Mille Eletronic 1.0 1989>2003, Prêmio 1.6/1.6 SPI 1990>1994, Tempra 2.0 8V/2.0 SPI 8V 1992>1998, Uno 1.3 MPI/1.5 SPI/1.6/1.6 MPI/1.6 R (MPI) 1989>2003

HONDA



GE1049

FEATURES / CARACTERÍSTICAS

Number of blades / Número de palas: 5
 Motor diameter / Diámetro del motor: 100mm
 Rotation sense / Sentido de rotación: Counter-Clockwise / Antihorario
 Power / Poder: 130W
 Propeller diameter / Diámetro de la hélice: 305mm
 Air conditioning / Aire acondicionado: with air / con aire
 PS: Same as GE1076 (but without deflector / sin defletor)

REPLACES / REEMPLAZA:

HONDA: 38611RNA01, 38616RNA

APPLICATION / APLICACIÓN:

HONDA: New Civic 1.8 16v 2006>2011

VW

GE1050
FEATURES / CARACTERÍSTICAS

Number of blades / Número de palas: 7
 Motor diameter / Diámetro del motor: 100mm
 Rotation direction / Sentido de rotación: Clockwise / Horario
 Aspirate or Blow / Aspira o Sopla: Aspirate / Aspira
 Power / Potencia: 100W
 Shaft diameter / Diámetro del eje: 6mm x 8mm
 Propeller diameter / Diámetro de la hélice: 300mm
 Air conditioning / Aire acondicionado: with and without air / con y sin aire

REPLACES / REEMPLAZA:

VW: 6K0 959 455B

APPLICATION / APLICACIÓN:

SEAT: Cordoba Mk1 Estate/Hatch 1.4/1.6 1996>1999, Ibiza Mk2 hatch 1.4 16v 2000>2002, Inca Van 1.4/1.6/1.7/1.9 1995>2003

VW: Caddy Mk2 Estate/Van/Pickup 1.4/1.6/1.9 1995>2004, Polo Classic Mk3 Saloon/Estate/Hatch 1995>2006

GM

GE1051 // NEW //
FEATURES / CARACTERÍSTICAS

Number of blades / Número de palas: 10
 Motor diameter / Diámetro del motor: 367mm
 Rotation direction / Sentido de rotación: Clockwise / Horario
 Power / Potencia: 275W
 Propeller diameter / Diámetro de la hélice: 138mm
 Air conditioning / Aire acondicionado: with air / con aire
 PS: with resistense / con resistencia

REPLACES / REEMPLAZA:

GM: 93382154

APPLICATION / APLICACIÓN:

GM: Corsa 1.4 8V/16V FLEX 2007>2011, Corsa 1.4 8V gasoline 2005, Corsa 1.8 8V FLEX 2005>2009, Corsa 1.8 8V Sport Flex/gasoline 2005>2011, Montana 1.4 8V Sport Flex 2009>2011, Montana 1.4 8V flex 2007>2011, Montana 1.8 8V flex 2005>2009, Montana 1.8 8V Sport flex 2005>2011, Montana 1.8 8V Gasoline

BOSCH

GE1052
FEATURES / CARACTERÍSTICAS

Number of blades / Número de palas: 5
 Motor diameter / Diámetro del motor: 100mm
 Rotation direction / Sentido de rotación: Clockwise / Horario
 Aspirate or Blow / Aspira o Sopla: Aspirate / Aspira
 Shaft diameter / Diámetro del eje: 8mm
 Power / Potencia: 155W
 Propeller diameter / Diámetro de la hélice: 360mm
 Air conditioning / Aire acondicionado: with air / con aire

REPLACES / REEMPLAZA:

BOSCH: 9 130 451 003

APPLICATION / APLICACIÓN:

GM: Ipanema 1.8 EFI/2.0 EFI/2.0 MPFI 1989>1993, Kadett 1.8/1.8 EFI/2.0 EFI/GS 2.0/GSI 2.0 1989>1993, Monza 1.8/1.8 EFI/2.0/2.0 EFI/2.0 MPFI 1989>1992

PEUGEOT

GE1054
FEATURES / CARACTERÍSTICAS

Number of blades / Número de palas: 6
 Motor diameter / Diámetro del motor: 76mm
 Rotation direction / Sentido de rotación: Clockwise / Horario
 Aspirate or Blow / Aspira o Sopla: Aspirate / Aspira
 Power / Potencia: 110W
 Shaft diameter / Diámetro del eje: 8mm
 Propeller diameter / Diámetro de la hélice: 315mm
 Air conditioning / Aire acondicionado: with - without air / con - sin aire

REPLACES / REEMPLAZA:

PEUGEOT / CITROËN: 125387, 125385, 125373, 125331, 125363

APPLICATION / APLICACIÓN:

CITROËN: AX 1.4 Gti 1991>1996, Berlingo 1.1 / 1.4 1996>2011, Xantia 1.8 1993>1998, Xsara 1.4/1.6/1.8 1997>2005

PEUGEOT: 306 1.4/1.6/1.8 1993>2001, 405 1.6/1.8/1.9 1987>1992, 605 2.1/2.5 1989>1999, Partner 1.4/1.6/1.8 1996>2015RENAULT: Logan I 1.4/1.6 2004->, Logan I Estate 1.4/1.6 2007->, Sandero Stepway I 1.4/1.6 2009->

RENAULT



GE1055

FEATURES / CARACTERÍSTICAS

Number of blades / Número de palas: 6
 Motor diameter / Diámetro del motor: 100mm
 Rotation direction / Sentido de rotación: Clockwise / Horario
 Power / Potencia: 215W
 Propeller diameter / Diámetro de la hélice: 380mm
 Air conditioning / Aire acondicionado: with air / con aire

REPLACES / REEMPLAZA:

Bosch: F 006 D10 034; **Renault:** 8200702959, 6001550769, 6001546844

APPLICATION / APLICACIÓN:

DACIA: Logan Saloon 1.4 2004->, Logan Saloon 1.6 2004->, Logan MCV Estate 1.4/1.6 2007->, Logan Express 1.4/1.6 2009->, Logan Pick-up 1.4/1.6 2008->, Sandero Hatch 1.4/1.6 2008->

RENAULT: Logan I 1.4/1.6 2004->, Logan I Estate 1.4/1.6 2007->, Sandero Stepway I 1.4/1.6 2009->

BOSCH



GE1056

FEATURES / CARACTERÍSTICAS

Number of blades / Número de palas: 6
 Motor diameter / Diámetro del motor: 76mm
 Rotation direction / Sentido de rotación: Clockwise / Horario
 Aspirate or Blow / Aspira o Sopla: Aspirate / Aspira
 Power / Potencia: 168W
 Shaft diameter / Diámetro del eje: 8mm
 Propeller diameter / Diámetro de la hélice: 320mm
 Air conditioning / Aire acondicionado: without air / sin aire

REPLACES / REEMPLAZA:

BOSCH: F 006 KMO 402

APPLICATION / APLICACIÓN:

VW: Gol II Special 1.0Mi/1.0i, 1.0Mi 8v/16V Special 1.6Mi/1.8i/1.8mi, 2.0Mi/2.0i 16V GTI 1999>2005, Gol III 1.0Mi/ 1.0Mi 16V/ 1.0mi 16V, 1.0mi total flex / 1.6mi/ 1.8mi 2005, Gol IV 1.0/1.0 total flex/1.6/ 1.6 total flex 1.8/ 1.8 total flex 2005, Parati II 1.0 Mi 16V 1999>2005, Saveiro III 1.6mi total flex, 1.8mi, 1.8 total flex 2000>2005, Saveiro IV 1.6 total flex, 1.8 total flex >2005

RENAULT



GE1057

FEATURES / CARACTERÍSTICAS

Number of blades / Número de palas: 6
 Motor diameter / Diámetro del motor: 76mm
 Rotation direction / Sentido de rotación: Clockwise / Horario
 Aspirate or Blow / Aspira o Sopla: Aspirate / Aspira
 Power / Potencia: 168W
 Shaft diameter / Diámetro del eje: 8mm
 Propeller diameter / Diámetro de la hélice: 320mm
 Air conditioning / Aire acondicionado: without air / sin aire

REPLACES / REEMPLAZA:

RENAULT: 7701051499

APPLICATION / APLICACIÓN:

RENAULT: Clio 1.0/ 1.6 16V 1997->

BOSCH



GE1058

FEATURES / CARACTERÍSTICAS

Number of blades / Número de palas: 4
 Motor diameter / Diámetro del motor: 76mm
 Rotation direction / Sentido de rotación: Clockwise / Horario
 Aspirate or Blow / Aspira o Sopla: Aspirate / Aspira
 Power / Potencia: 102W
 Propeller diameter / Diámetro de la hélice: 279mm
 Air conditioning / Aire acondicionado: without air / sin aire

REPLACES / REEMPLAZA:

BOSCH: 9 130 081 058

APPLICATION / APLICACIÓN:

FIAT: Fiorino Furgão 1.0/1.0 SPI/1.3/1.5 1988>1995, Fiorino Pick-up 1.0/1.0 SPI/1.3/1.5 1988>1995, Prêmio 1.3/1.5/1.6 1985>1992, Uno 1.1 Brio/1.3/1.5/1.6R 19/84>1995, Uno Mille 1.0 1984>1995

BOSCH



GE1059

FEATURES / CARACTERÍSTICAS

Number of blades / Número de palas: 5
 Motor diameter / Diámetro del motor: 100mm
 Rotation direction / Sentido de rotación: Clockwise / Horario
 Aspirate or Blow / Aspira o Sopla: Aspirate / Aspira
 Shaft diameter / Diámetro del eje: 8mm
 Power / Potencia: 252W
 Propeller diameter / Diámetro de la hélice: 360mm
 Air conditioning / Aire acondicionado: with air / con aire

REPLACES / REEMPLAZA:

BOSCH: 9 130 451 124; **GM:** 93217911

APPLICATION / APLICACIÓN:

CHEVROLET: Ipanema 1.8 EFI/2.0 EFI/2.0 MPFI 1993>1997, Kadett 1.8 EFI/2.0 EFI/2.0 GSI/2.0 MPFI 1996>1998, Monza 1.8 EFI/2.0 EFI 1993>1996, S10 2.2 EFI/2.2 MPFI/2.4 MPFI 1995>

VALEO

GE1060
FEATURES / CARACTERÍSTICAS

Number of blades / Número de palas: 11
 Motor diameter / Diámetro del motor: 100mm
 Rotation direction / Sentido de rotación: Clockwise / Horario
 Aspirate or Blow / Aspira o Sopla: Aspirate / Aspira
 Shaft diameter / Diametro del eje: 8mm
 Power / Potencia: 228W
 Propeller diameter / Diámetro de la hélice: 280mm
 Air conditioning / Aire acondicionado: with air / con aire

REPLACES / REEMPLAZA:

VALEO: 698603R; GM: 93360613

APPLICATION / APLICACIÓN:

CHEVROLET: Celta 1.0 8V MPFi 2001>2007, Celta 1.4 8V MPFi 2001>2006, Celta Life / Spirit/ Super 1.0 8V VHC 2002>2006, Celta Life / Spirit/ Super 1.4 8V VHC 20 02>2006

VALEO

GE1061
FEATURES / CARACTERÍSTICAS

Number of blades / Número de palas: 5
 Motor diameter / Diámetro del motor: 70mm
 Rotation direction / Sentido de rotación: Clockwise / Horario
 Aspirate or Blow / Aspira o Sopla: Aspirate / Aspira
 Shaft diameter / Diametro del eje: 8mm x 15mm
 Power / Potencia: 143W
 Propeller diameter / Diámetro de la hélice: 322mm
 Air conditioning / Aire acondicionado: without air / sin aire

REPLACES / REEMPLAZA:

VALEO: 696054R, 698600R; GM: 93337577; **FIAT:** 46815900

APPLICATION / APLICACIÓN:

CHEVROLET: Prisma 1.0/1.4 2006>2012, Celta 1.0/1.4 2006->

FIAT: Fiorino 8V fire 1.0/1.3 2002>2007, Palio 1.0 8v/16v / 1.0 fire, 1.3 16v, 1.5 mpi 2002>2007, Siena 1.0 8v/16v / 1.0 fire / 1.3 16v, 1.5 mpi 2002>2007, Strada 1.0 8v/16v / 1.0 fire / 1.3 16v / 1.5 mpi 2002>2007, Uno 1.0, 1.3 8v fire gasoline 2002>2007

VW

GE1062
FEATURES / CARACTERÍSTICAS

Number of blades / Número de palas: 11
 Motor diameter / Diámetro del motor: 82mm
 Rotation direction / Sentido de rotación: Clockwise / Horario
 Aspirate or Blow / Aspira o Sopla: Aspirate / Aspira
 Power / Potencia: 160W
 Shaft diameter / Diametro del eje: 8mm
 Propeller diameter / Diámetro de la hélice: 303mm
 Air conditioning / Aire acondicionado: with air / con aire

REPLACES / REEMPLAZA:

VW: 1H0 959 455 AB, 1H0 959 455 B, 1H0 959 455 J

APPLICATION / APLICACIÓN:

VW: Golf Mk3 Hatch/Estate 1.8/2.0 1991>1999, Vento 1.8/1.9/2.0 1991>1998

DENSO

GE1063 // NEW //
FEATURES / CARACTERÍSTICAS

Number of blades / Numero de aspas: 9
 Motor diameter / Diámetro del motor: 100mm
 Rotation direction / Sentido de rotación: Horario
 Power / Potencia: 300W
 Propeller diameter / Diámetro de la hélice: 405mm
 Ps: with air conditioning, without deflector / con aire acondicionado, sin deflector

REPLACES / REEMPLAZA:

Denso: BC422750-8213RC; **Chevrolet:** 52047984, 52096866, 95962654

APPLICATION / APLICACIÓN:

CHEVROLET: Aveo hatchback 1.6 2011>, Aveo saloon 1.6 2011>, Sonic 1.6 2012>2017

VW

GE1064
FEATURES / CARACTERÍSTICAS

Number of blades / Número de palas: 7
 Motor diameter / Diámetro del motor: 101mm
 Rotation direction / Sentido de rotación: Clockwise / Horario
 Power / Potencia: 250W
 Propeller diameter / Diámetro de la hélice: 391mm
 Air conditioning / Aire acondicionado: with air / con aire

REPLACES / REEMPLAZA:

VOLKSWAGEN: 5U0.121.253E, 5U0.959.455B, 5U0.959.455C

APPLICATION / APLICACIÓN:

VOLKSWAGEN: Fox 1.0/1.6 2007->, Gol GV 1.0/1.6 2008->, Golf 1.6 2006>2012, Polo 1.6 2006>2012, Saveiro GV 1.0/1.6 2008->, Space Fox 2006->, Voyage GV 1.0/1.6 2008->

HYUNDAI



GE1065

FEATURES / CARACTERÍSTICAS

Number of blades / Número de palas: 7
 Motor diameter / Diámetro del motor: 105mm
 Rotation sense / Sentido de rotación: Clockwise / Horario
 Power / Poder: 180W
 Propeller diameter / Diámetro de la hélice: 390mm
 Air conditioning / Aire acondicionado: with air / con aire
 Ps: with resistance - without deflector / con resistencia - sin deflector

REPLACES / REEMPLAZA:

HYUNDAI: 25380-1R050

APPLICATION / APLICACIÓN:

HYUNDAI: Veloster 1.6 2011>

VW



GE1066

FEATURES / CARACTERÍSTICAS

Number of blades / Número de palas: 7
 Motor diameter / Diámetro del motor: 105mm
 Rotation direction / Sentido de rotación: Anti-Clockwise / Anti-Horario
 Power / Potencia: 180W
 Propeller diameter / Diámetro de la hélice: 390mm
 Air conditioning / Aire acondicionado: with air / con aire
 PS: with resistance / con resistencia

REPLACES / REEMPLAZA:

VW: 1J0959455B, 6E0959455A

APPLICATION / APLICACIÓN:

VW: Bora Saloon/Estate 1.8/1.9 1998>2005, Fox hatch 1.2 2005->, Golf Mk4 Estate 1.9/2.0 1999>2006, Polo Mk4 hatch 1.4 16v 2006>2009

SKODA: Fabia Mk1 Hatch/Saloon/Estate 1.2/1.4/1.9 1999>2008, Fabia Mk2 Hatch/Estate 1.4 2006>2014, Octavia Mk1 Hatch/Estate 1.8/1.9 1996>2010, Roomster Mpv 1.4 2006>2015

VW



GE1067

FEATURES / CARACTERÍSTICAS

Number of blades / Número de palas: 7
 Motor diameter / Diámetro del motor: 110mm
 Rotation direction / Sentido de rotación: Anti-Clockwise / Anti-Horario
 Power / Potencia: 235W
 Propeller diameter / Diámetro de la hélice: 392mm
 Air conditioning / Aire acondicionado: with air / con aire

REPLACES / REEMPLAZA:

VW: 6Q0959455AD, 6R0959455E

APPLICATION / APLICACIÓN:

SEAT: Cordoba Mk2 Saloon 1.2/1.4/1.9 2002>2009, Ibiza Mk4 hatch 1.2/1.4/1.9 2002>2009, Ibiza Mk5 hatch 1.4/1.6 2008>, Ibiza Mk5 Sportcoupe 1.2/1.4/1.6 2008>, Ibiza IV ST 1.2/1.4/1.6 2010>

BOSCH



GE1068 // NEW //

FEATURES / CARACTERÍSTICAS

Number of blades / Numero de aspas: 7
 Motor diameter / Diámetro del motor: 100mm
 Rotation direction / Sentido de rotación: horario
 Aspirate or Blow / Aspira o Sopla: Aspirate / Aspira
 Power / Potencia: 335W
 Shaft diameter / Diámetro do eixo: 8mm
 Propeller diameter / Diámetro de la hélice: 375mm
 PS: with air conditioning / con aire acondicionado

REPLACES / REEMPLAZA:

Bosch: F 006 KM0 60D; **Fiat:** 46760459

APPLICATION / APLICACIÓN:

FIAT: Brava 2001>2005, Ducato 2.8 2001>2003 (driver side), Marea 2001>2005

PEUGEOT: Boxer 2000> (driver side)

CITROËN: Jumper 200-> (driver side)

RENAULT



GE1069

FEATURES / CARACTERÍSTICAS

Number of blades / Número de palas: 6
 Motor diameter / Diámetro del motor: 100mm
 Rotation sense / Sentido de rotación: Clockwise / Horario
 Power / Poder: 384W
 Propeller diameter / Diámetro de la hélice: 375mm
 Air conditioning / Aire acondicionado: with air / con aire
 Ps: with resistance / con resistencia

REPLACES / REEMPLAZA:

RENAULT: 214814567R

APPLICATION / APLICACIÓN:

DACIA: Duster 1.6 16V 2010>

FIAT

GE1070
FEATURES / CARACTERÍSTICAS

Number of blades / Número de palas: 8
 Motor diameter / Diámetro del motor: 122mm
 Rotation direction / Sentido de rotación: Clockwise / Horario
 Aspirate or Blow / Aspira o Sopla: Aspirate / Aspira
 Power / Potencia: 220W
 Propeller diameter / Diámetro de la hélice: 367mm
 Air conditioning / Aire acondicionado: with air / con aire

REPLACES / REEMPLAZA:

FIAT: 51712739

APPLICATION / APLICACIÓN:

FIAT: Doblò 1.3, 1.6 16v fire gasoline, Doblò 1.6 16v gasoline 2002>2003, Doblò 1.8 8v flex 2006>2009, Doblò 1.8 8v gasoline

FIAT

GE1071
FEATURES / CARACTERÍSTICAS

Number of blades / Número de palas: 6
 Motor diameter / Diámetro del motor: 105mm
 Rotation direction / Sentido de rotación: Clockwise / Horario
 Aspirate or Blow / Aspira o Sopla: Aspirate / Aspira
 Power / Potencia: 200W
 Propeller diameter / Diámetro de la hélice: 367mm
 Air conditioning / Aire acondicionado: without air / sin aire

REPLACES / REEMPLAZA:

FIAT: 46811843

APPLICATION / APLICACIÓN:

FIAT: Doblò 1.3/1.6 16v fire gasoline, Doblò 1.6 16v gasoline 2002>2003, Doblò 1.8 8v flex 2006>2009, Doblò 1.8 8v gasoline

VALEO

GE1072 // NEW //
FEATURES / CARACTERÍSTICAS

Number of blades / Numero de aspas: 7
 Motor diameter / Diámetro del motor: 95mm
 Rotation sense / Sentido de rotación: Clockwise / Horario
 Power / Potencia: 240W
 Propeller diameter / Diámetro de la hélice: 330mm
 Air conditioning / Aire acondicionado: With air / Con aire
 PS: With resistance / Con resistencia

REPLACES / REEMPLAZA:

VW/ Seat/ Skoda: 1S0959455B, 1S0121207E, 1S0121207J; **Valeo:** 696857

APPLICATION / APLICACIÓN:

VW: Up 1.0 TSI / EcoFuel 2011->, Load Up 1.0 EcoFuel 2014->

SEAT: Mii 1.0 EcoFuel 2011->

SKODA: Citigo 1.0 2011->

FIAT

GE1073 // NEW //
FEATURES / CARACTERÍSTICAS

Number of blades / Numero de aspas: 7
 Motor diameter / Diámetro del motor: 100mm
 Rotation sense / Sentido de rotación: Clockwise / Horario
 Power / Potencia: 270W
 Propeller diameter / Diámetro de la hélice: 384mm
 Air conditioning / Aire acondicionado: With air / Con aire
 PS: With deflector / Con deflector

REPLACES / REEMPLAZA:

FIAT: 51846311, 51846313; **Valeo:** 700861R

APPLICATION / APLICACIÓN:

FIAT: Grand Siena Attractive 1.4 mpi fire 8v 2013>, Grand Siena Attractive 1.4 mpi fire 8v flex (tetrafuel) 2013>, Nova Fiorino 2011>2014, Novo Uno 2011>2016, Palio Attractive 1.0 mpi fire Evo 8v flex 2012>2015, Palio Attractive 1.0 mpi fire Evo 8v flex 2015>, Palio Attractive 1.4 mpi 8V Flex 2012>2015, Palio Attractive 1.4 mpi 8V Flex 2015>

BOSCH

GE1074
FEATURES / CARACTERÍSTICAS

Number of blades / Número de aspas: 7
 Power / Potencia: 246W

REPLACES / REEMPLAZA:

Fiat: 1358012080, 1347697080

APPLICATION / APLICACIÓN:

FIAT: Ducato Van 100 Multijet 2,2 D 2006>, 120 Multijet 2,3 D 2006>, 130 Multijet 2,3 D 2011>, 150 Multijet 2,3 D 2011>, 160 Multijet 3,0 D 2006> / Ducato Flatbed 100 Multijet 2,2 D 2006>, 110 Multijet 2,3 D 2011>, 120 Multijet 2,3 D 2006>, 130 Multijet 2,3 D 2006>, 150 Multijet 2,3 D 2011>, 160 Multijet 3,0 D 2006>

TOYOTA



GE1075

FEATURES / CARACTERÍSTICAS

Number of blades / Número de palas: 5
 Motor diameter / Diámetro del motor: 101mm
 Rotation direction / Sentido de rotación: Counter-Clockwise / Antihorario
 Power / Potencia: 103W
 Propeller diameter / Diámetro de la hélice: 358mm
 Air conditioning / Aire acondicionado: with air / con aire
 Ps.: with resistance and deflector/ con resistencia y deflector

REPLACES / REEMPLAZA:

Fiat: 1358012080, 1347697080

APPLICATION / APLICACIÓN:

TOYOTA: Corolla hatch 1.4/1.6/1.8 2002>2007, Corolla saloon 1.4/1.6 2001>2007, Corolla estate 1.4/1.6 2002>2007, Corolla verso MK1 1.6/1.8 2001>2004

HONDA



GE1076 // NEW //

FEATURES / CARACTERÍSTICAS

Number of blades / Número de aspas: 5
 Motor diameter / Diámetro del motor: 100mm
 Rotation Direction / Sentido de rotación: Counter-Clockwise / Antihorario
 Power / Potencia: 300W
 Propeller diameter / Diámetro de la hélice: 305mm
 Ps: Same as GE1049 (but with deflector / con defletor), without resistance / sin resistencia

REPLACES / REEMPLAZA:

Honda: 19030-RNA-A51, 38605-PLC-1013

APPLICATION / APLICACIÓN:

HONDA: Civic Mk7 1.4 2005>2008, Civic Mk7 hatch 1.8 2005>, Civic Mk7 saloon 1.8 2005>2012

RENAULT



GE1077 // NEW //

FEATURES / CARACTERÍSTICAS

Number of blades / Numero de aspas: 6
 Motor diameter / Diámetro del motor: 76mm
 Rotation sense / Sentido de rotación: horario
 Aspirate or Blow / Aspira o Sopla: Aspirate / Aspira
 Shaft diameter / Diámetro do eixo: 8mm
 Power / Potencia: 60W
 Propeller diameter / Diámetro de la hélice: 298mm

REPLACES / REEMPLAZA:

RENAULT: 7702298178

APPLICATION / APLICACIÓN:

RENAULT: Clio MK 2 hatch 1.2/1.5/1.9 1998>2009, Kangoo MK 1 van 1.2 1998>2001

GM



GE1078

FEATURES / CARACTERÍSTICAS

Number of blades / Número de palas: 7
 Motor diameter / Diámetro del motor: 100mm
 Rotation sense / Sentido de rotación: Clockwise / Horario
 Power / Poder: 260W
 Propeller diameter / Diámetro de la hélice: 325mm
 Ps: with air conditioning, with resistance

REPLACES / REEMPLAZA:

RADIATOR COOLING FAN: **CHEVROLET:** 94722524

DEFLECTOR: **CHEVROLET:** 52028192 and old 94722522

APPLICATION / APLICACIÓN:

CHEVROLET: Classic 1.0/1.6 (Flex/Gasoline) 2012>2017

GM



GE1079

FEATURES / CARACTERÍSTICAS

Number of blades / Número de palas: 7
 Motor diameter / Diámetro del motor: 100mm
 Rotation sense / Sentido de rotación: Clockwise / Horario
 Power / Poder: 260W
 Propeller diameter / Diámetro de la hélice: 325mm
 Ps: with air conditioning, with resistance

REPLACES / REEMPLAZA:

Chevrolet: 94722524

APPLICATION / APLICACIÓN:

CHEVROLET: Classic 1.0/1.6 (Flex/Gasoline) 2012>2017

GM

GE1080
FEATURES / CARACTERÍSTICAS

Number of blades / Número de palas: 7
 Motor diameter / Diámetro del motor: 100mm
 Rotation sense / Sentido de rotación: Clockwise / Horario
 Power / Poder: 100W
 Propeller diameter / Diámetro de la hélice: 325mm
 Ps: without air conditioning, without resistance

REPLACES / REEMPLAZA:
Chevrolet: 94722525

APPLICATION / APLICACIÓN:
CHEVROLET: Classic 1.0/1.4 MFI (Flex/Gasolina) 2012>2017

GM

GE1081
FEATURES / CARACTERÍSTICAS

Number of blades / Número de palas: 7
 Motor diameter / Diámetro del motor: 100mm
 Rotation sense / Sentido de rotación: Clockwise / Horario
 Power / Poder: 100W
 Propeller diameter / Diámetro de la hélice: 325mm
 Ps: without air conditioning

REPLACES / REEMPLAZA:
RADIATOR COOLING FAN: CHEVROLET: 94722525

DEFLECTOR: CHEVROLET: 94722522

APPLICATION / APLICACIÓN:
CHEVROLET: Classic 1.0/1.4 MFI (Flex/Gasolina) 2012>2017

FIAT

GE1082 // NEW //
FEATURES / CARACTERÍSTICAS

Number of blades / Numero de aspas: 7
 Air conditioning / Aire acondicionado: With air / Con aire
 PS: With resistance / Con resistencia

REPLACES / REEMPLAZA:
Fiat: 51840940, 51985154; **Bosch:** F006 B10 347, F006 B10 348

APPLICATION / APLICACIÓN:
FIAT: Doblò 1.4 16v / 1.8 8v / 1.8 16v

VW

GE1083 // NEW //
FEATURES / CARACTERÍSTICAS

Number of blades / Numero de aspas: 7
 Motor diameter / Diámetro del motor: 95mm
 Rotation direction / Sentido de rotación: horario
 Power / Potencia: 120W
 Propeller diameter / Diámetro de la hélice: 330mm
 Air conditioning / Aire acondicionado: Without air / Sin aire

REPLACES / REEMPLAZA:
VW: 1S0959455A

APPLICATION / APLICACIÓN:
VOLKSWAGEN: UP 1.0 2011>, UP 1.0 EcoFuel 2012>, Load UP 1.0 EcoFuel 2014>, UP 1.0 TSI 2016>

SEAT: Mii 1.0 EcoFuel 2011>

SKODA: Citigo 1.0 2011

FIAT

GE1084 // NEW //
FEATURES / CARACTERÍSTICAS

Number of blades / Número de aspas: 7
 Propeller diameter / Diámetro de la hélice: 384 mm
 Motor diameter / Diámetro del motor: 100 mm
 Rotation Sense / Sentido de rotación: Horário
 Power / Potencia: 270W
 Air conditioning / Aire acondicionado: With air / con aire
 PS: Without deflector, same GE1073 (with deflector) / Sin defletor, igual a GE1073 (con deflector).

REPLACES / REEMPLAZA:
Fiat: 51846311 , 51846313

Valeo: 700861R

APPLICATION / APLICACIÓN:
FIAT: Grand Siena Attractive 1.4 mpi fire 8v 2013>, Grand Siena Attractive 1.4 mpi fire 8v flex (tetrafuel) 2013>, Nova Fiorino 2011>2014, Novo Uno 2011>2016, Palio Attractive 1.0 mpi fire Evo 8v flex 2012>2015, Palio Attractive 1.0 mpi fire Evo 8v flex 2015>, Palio Attractive 1.4 mpi 8V Flex 2012>2015, Palio Attractive 1.4 mpi 8V Flex 2015>

GM



GE1085

FEATURES / CARACTERÍSTICAS

Number of blades / Número de palas: 7
 Motor diameter / Diámetro del motor: 113mm
 Rotation sense / Sentido de rotación: Clockwise / Horario
 Power / Poder: 300W
 Propeller diameter / Diámetro de la hélice: 360mm
 Ps: with air conditioning, deflector and resistance

REPLACES / REEMPLAZA:

Chevrolet: 3125GM16P, 5000309, 52409926, 93341928, 93341929, GM16P, MP8125

APPLICATION / APLICACIÓN:

CHEVROLET: Meriva 1.4 / 1.8 Flex 2006>

VW



GE1086

FEATURES / CARACTERÍSTICAS

Number of blades / Número de palas: 6
 Motor diameter / Diámetro del motor: 79mm
 Rotation direction / Sentido de rotación: Counter-Clockwise / Antihorario
 Power / Potencia: 73W
 Propeller diameter / Diámetro de la hélice: 274mm
 Air conditioning / Aire acondicionado: without air / sin aire

REPLACES / REEMPLAZA:

Toyota: 16363-23020, 16711-22100

APPLICATION / APLICACIÓN:

VOLKSWAGEN: Golf Mk2 hatch 1.6 1983>1991, Passat Mk2 hatch 1.6 1980>1988, Passat Mk3/Mk4 saloon 1.6/1.8 1988>1996, Polo Mk2 hatch 1.3 1986>1990, Caddy Pickup 1.5/1.6/1.8 1982>1992

SEAT: Cordoba Mk1 saloon 1.4/1.6/1.8/2.0 1993>2002, Ibiza Mk2 hatch 1.0/1.3/1.4/1.6/2.0 1993>2002

VW



GE1087

FEATURES / CARACTERÍSTICAS

Number of blades / Número de palas: 4
 Motor diameter / Diámetro del motor: 79mm
 Rotation direction / Sentido de rotación: Counter-Clockwise / Antihorario
 Power / Potencia: 168W
 Propeller diameter / Diámetro de la hélice: 275mm

REPLACES / REEMPLAZA:

VOLKSWAGEN / AUDI: 357959455A, 811959455P, 811959455E, 323959455

APPLICATION / APLICACIÓN:

VOLKSWAGEN: Passat Mk2 hatch/saloon/estate 1.6/1.8 1983>1988, Passat Mk3/4 saloon/estate 1.6/1.8/1.9/2.0 1988>1996, Santana 1.8 1983>1984

AUDI: 80 Mk3 saloon 1.6/1.8 1986>1991, 100 Mk3 saloon/avant/estate 1.8 1983>1990

VW



GE1088

FEATURES / CARACTERÍSTICAS

Number of blades / Número de palas: 9
 Motor diameter / Diámetro del motor: 79mm
 Rotation direction / Sentido de rotación: Clockwise / Horario
 Power / Potencia: 110W
 Propeller diameter / Diámetro de la hélice: 290mm

REPLACES / REEMPLAZA:

VOLKSWAGEN: 330959455A

APPLICATION / APLICACIÓN:

VOLKSWAGEN: Passat Mk5 saloon/estate 1.9/2.0 2000>2005

VW



GE1089

FEATURES / CARACTERÍSTICAS

Number of blades / Número de palas: 8
 Motor diameter / Diámetro del motor: 127mm
 Rotation direction / Sentido de rotación: Clockwise / Horario
 Power / Potencia: 246W
 Propeller diameter / Diámetro de la hélice: 280mm

REPLACES / REEMPLAZA:

VOLKSWAGEN / AUDI / SEAT: 8D0959455C, 8D0959455, 4B0959455

APPLICATION / APLICACIÓN:

VOLKSWAGEN: Passat Mk5 saloon/estate 1.6/1.8/2.5 1996>200, Sharan 1.9/2.0 1995>2010

AUDI: A4 Mk1 saloon/avant/estate 1.6/1.8/2.5 1994>2001, A8 Mk1 Saloon 2.8 1994>1996

SEAT: Alhambra MPV 1.8/1.9/2.0 1996>2010

VW

GE1090
FEATURES / CARACTERÍSTICAS

Number of blades / Número de palas: 6
 Motor diameter / Diámetro del motor: 79mm
 Rotation direction / Sentido de rotación: Counter-Clockwise / Antihorario
 Power / Potencia: 73W
 Propeller diameter / Diámetro de la hélice: 276mm

REPLACES / REEMPLAZA:

Audi: 811959455R

APPLICATION / APLICACIÓN:

AUDI: 80 Mk2 Saloon 1.9/2.0 1981>1984, 80 Mk3 Saloon 1.6/1.8/2.0 1986>1991, Coupe 2.0 1989>1996, Cabriolet 2.0 1993>1998, 80 Mk4 Saloon/Avant/Estate 1.6/2.0 1991>1994, 100 Mk3 Saloon/Avant/Estate 1.8 1983>1990

VW

GE1091
FEATURES / CARACTERÍSTICAS

Number of blades / Número de palas: 6
 Motor diameter / Diámetro del motor: 79mm
 Rotation direction / Sentido de rotación: Counter-Clockwise / Antihorario
 Power / Potencia: 93W
 Propeller diameter / Diámetro de la hélice: 274mm

REPLACES / REEMPLAZA:

VW / Audi / Seat: 165959455AM, 130109237, 321959455N

APPLICATION / APLICACIÓN:

VOLKSWAGEN: Golf Mk1 Hatch 1.5/1.6/1.8 1976>1983, Jetta Mk1/Mk2 Saloon 1.5/1.6/1.8 1978>1984, Passat Mk2 hatch/saloon/estate 1.3/1.6/1.9 1980>1988, Polo Classic Mk2 1.3 1986>1994, Santana 1.3/1.6/1.9 1981>1984

AUDI: 80 Mk2 Saloon 1.3/1.6/1.8, Coupe 1.6/1.8 1980>1988

SEAT: Cordoba Mk1 saloon/estate 1.6/1.8/2.0 1993>2002, Ibiza Mk2 hatch 1.6/1.8/2.0 1993>2002, Inca Van 1.4 1995>2003, Toledo Mk1 hatch 1.8/2.0 1991>1999

VW

GE1092
FEATURES / CARACTERÍSTICAS

Number of blades / Número de palas: 6
 Motor diameter / Diámetro del motor: 79mm
 Rotation direction / Sentido de rotación: Counter-Clockwise / Antihorario
 Power / Potencia: 66W
 Propeller diameter / Diámetro de la hélice: 274mm

REPLACES / REEMPLAZA:

VW: 9137041079, BAT959455

APPLICATION / APLICACIÓN:

VOLKSWAGEN: Caribe Beetle

VW

GE1093
FEATURES / CARACTERÍSTICAS

Number of blades / Número de palas: 10
 Motor diameter / Diámetro del motor: 79mm
 Rotation direction / Sentido de rotación: Counter-Clockwise / Antihorario
 Power / Potencia: 93W
 Propeller diameter / Diámetro de la hélice: 303mm

REPLACES / REEMPLAZA:

VW: 357959455F

APPLICATION / APLICACIÓN:

VOLKSWAGEN: Passat Mk3/ 4 Saloon/ Estate 1.8/ 1.9 1988>1997

VW

GE1094
FEATURES / CARACTERÍSTICAS

Number of blades / Número de palas: 4
 Motor diameter / Diámetro del motor: 79mm
 Rotation direction / Sentido de rotación: Counter-Clockwise / Antihorario
 Power / Potencia: 81W
 Propeller diameter / Diámetro de la hélice: 275mm

REPLACES / REEMPLAZA:

VW: 353959455D

APPLICATION / APLICACIÓN:

VOLKSWAGEN: Passat Mk3/4 Saloon/Estate 1.6/1.8/2.0 1988>1996

VW

GE1095
FEATURES / CARACTERÍSTICAS

Number of blades / Número de palas: 7
 Motor diameter / Diámetro del motor: 101mm
 Rotation direction / Sentido de rotación: Counter-Clockwise / Antihorario
 Power / Potencia: 300W
 Propeller diameter / Diámetro de la hélice: 345mm

REPLACES / REEMPLAZA:

VW: 701959455L, 701959455K

APPLICATION / APLICACIÓN:

VOLKSWAGEN: Transporter T4 Minibus 1.8/ 1.9/ 2.0/ 2.4/ 2.5/ 2.8 1990>2003, Transporter T4 Van 1.9/ 2.0/ 2.4/ 2.5 1990>2003, Transporter T4 Flatbed 1.9/ 2.4/ 2.5

VW



GE1096

FEATURES / CARACTERÍSTICAS

Number of blades / Número de palas: 6
 Motor diameter / Diámetro del motor: 79mm
 Rotation direction / Sentido de rotación: Counter-Clockwise / Antihorario
 Power / Potencia: 57W
 Propeller diameter / Diámetro de la hélice: 274mm

REPLACES / REEMPLAZA:

VW: 165959455L, 191959455L, 165959455G

APPLICATION / APLICACIÓN:

VOLKSWAGEN: Derby Mk1 Saloon 0.9/1.1/1.3 1977>1981, Golf Mk1 Hatch/Cabriolet 1.5/1.6 1974>1984, Jetta Mk1/Mk2 Saloon 1.5/1.6 1979>1984, Passat Mk1 Hatch/Estate 1.3/1.6 1973>1980, Polo Mk1 Hatch 1.1/1.3 1975>1981

VW



GE1097

FEATURES / CARACTERÍSTICAS

Number of blades / Número de palas: 7
 Motor diameter / Diámetro del motor: 101mm
 Rotation direction / Sentido de rotación: Counter-Clockwise / Antihorario
 Power / Potencia: 198W
 Propeller diameter / Diámetro de la hélice: 310mm

REPLACES / REEMPLAZA:

VW: 7M0959455J

APPLICATION / APLICACIÓN:

VOLKSWAGEN: Sharan 2.8 VR6 Syncro 1995>2000

VW



GE1098

FEATURES / CARACTERÍSTICAS

Number of blades / Número de palas: 9
 Motor diameter / Diámetro del motor: 101mm
 Rotation direction / Sentido de rotación: Clockwise / Horario
 Power / Potencia: 96W
 Propeller diameter / Diámetro de la hélice: 290mm

REPLACES / REEMPLAZA:

VW: 330959455B

APPLICATION / APLICACIÓN:

VOLKSWAGEN: Santana 2000/3000 1996>2014

VW



GE1099

FEATURES / CARACTERÍSTICAS

Number of blades / Número de palas: 7
 Motor diameter / Diámetro del motor: 79mm
 Rotation direction / Sentido de rotación: Counter-Clockwise / Antihorario
 Power / Potencia: 83W
 Propeller diameter / Diámetro de la hélice: 342mm

REPLACES / REEMPLAZA:

VW: 3A0959455B; BERU: LE032

APPLICATION / APLICACIÓN:

VOLKSWAGEN: Passat Mk3/ 4 Saloon/ Estate 1.6/ 1.8/ 1.9/ 2.0/ 2.8 1988>1996

VW



GE1100

FEATURES / CARACTERÍSTICAS

Number of blades / Número de palas: 10
 Motor diameter / Diámetro del motor: 101mm
 Rotation direction / Sentido de rotación: Counter-Clockwise / Antihorario
 Power / Potencia: 180W
 Propeller diameter / Diámetro de la hélice: 280mm

REPLACES / REEMPLAZA:

Audi: 4A0959455C, 893959455F, 893959455G

APPLICATION / APLICACIÓN:

AUDI: A6 Mk1 Saloon/ Avant/ Estate 1.8/ 1.9/ 2.0/ 2.6/ 2.8 1994>1997, 80 Mk3 Saloon 2.0 16v 1990>1991, Coupe 2.0 16v / 2.8 1991>1996, Cabriolet 2.0 16v / 2.6, 2.8 1992>2000, 80 Mk4 Saloon/ Avant/ Estate 2.0/ 2.8 1991>1994, 100 Mk4 Saloon/ Avant/ Estate 2.0/ 2.6/ 2.8 1990>1994

VW



GE1101

FEATURES / CARACTERÍSTICAS

Number of blades / Número de palas: 7
 Motor diameter / Diámetro del motor: 126mm
 Rotation direction / Sentido de rotación: Counter-Clockwise / Antihorario
 Power / Potencia: 258W
 Propeller diameter / Diámetro de la hélice: 305mm

REPLACES / REEMPLAZA:

VW / Audi: 8D0959455J

APPLICATION / APLICACIÓN:

VOLKSWAGEN: Passat Mk5 Saloon 2.8 V6 1996>2000

AUDI: A4, A6

VW

GE1102
FEATURES / CARACTERÍSTICAS

Number of blades / Número de palas: 11
 Motor diameter / Diámetro del motor: 101mm
 Rotation direction / Sentido de rotación: Counter-Clockwise / Antihorario
 Power / Potencia: 168W
 Propeller diameter / Diámetro de la hélice: 282mm

REPLACES / REEMPLAZA:

VW: 701959455AM, 701959455C

APPLICATION / APLICACIÓN:

VOLKSWAGEN: Transporter T4 Van/ Mini Bus/ Flatbed 1.9/ 2.0/ 2.4/ 2.5 1990>2003

VW

GE1103
FEATURES / CARACTERÍSTICAS

Number of blades / Número de palas: 7
 Motor diameter / Diámetro del motor: 79mm
 Rotation direction / Sentido de rotación: Counter-Clockwise / Antihorario
 Power / Potencia: 66W
 Propeller diameter / Diámetro de la hélice: 317mm

REPLACES / REEMPLAZA:

VW: 1H0959455, 130107268

APPLICATION / APLICACIÓN:

VOLKSWAGEN: Corrado 1.8/2.0 1989>1995, Golf Mk3 Hatch/Estate/Cabriolet 1.4/1.6/1.8/1.9/2.0 1991>1997, Passat Mk3/Mk4 Saloon/Estate 1.6/1.8/2.0 1988>1996, Polo Mk2 Hatch/Coupe/Van 1.4 1990>1994, Vento 1.4/1.6/1.8/1.9/2.0 1991>1998

HYUNDAI

GE1104
FEATURES / CARACTERÍSTICAS

Number of blades / Número de palas: 7
 Motor diameter / Diámetro del motor: 105mm
 Rotation direction / Sentido de rotación: Clockwise / Horario
 Power / Poder: 180W
 Propeller diameter / Diámetro de la hélice: 390mm
 Air conditioning / Aire acondicionado: with air / con aire
 Ps: with resistance / con resistencia

REPLACES / REEMPLAZA:

Hyundai: 25380-1R050

APPLICATION / APLICACIÓN:

HYUNDAI: Veloster 1.6 2011>

HONDA

GE1105 // NEW //
FEATURES / CARACTERÍSTICAS

Number of blades / Numero de aspas: 7
 Power / Potencia: 194.4W
 Aspirate or Blow / Aspira o Sopla: Blow / Sopla

REPLACES / REEMPLAZA:

Honda: 18A0011420, 190305AAA01 (FAN ENGINE/ MOTOR DO VENTILADOR), 190205AAA01 (FAN PROPELLER/ HELICE DEL MOTOR), 190155AAA01 (DEFLECTOR)

APPLICATION / APLICACIÓN:

HONDA: Civic EX-L/EX-T/Touring 1.5 2016>2017, Civic EX/LX/SI/Sport/Turbo 1.5 2017

CHEVROLET

GE1106 // NEW //
FEATURES / CARACTERÍSTICAS

Number of blades / Numero de aspas: 7

REPLACES / REEMPLAZA:

Chevrolet: 39013323 (DEFLECTOR)

APPLICATION / APLICACIÓN:

CHEVROLET: New Cruze Automatic 2017>2020

CHEVROLET

GE1107 // NEW //
FEATURES / CARACTERÍSTICAS

Number of blades / Numero de aspas: 7

REPLACES / REEMPLAZA:

Chevrolet: 39030262

APPLICATION / APLICACIÓN:

CHEVROLET: New Cruze manual 1.4 >2017

CHEVROLET



GE1108 // NEW //

FEATURES / CARACTERÍSTICAS

Number of blades / Numero de aspas: 7
Aspirate or Blow / Aspira o Sopla: Blow / Sopla

REPLACES / REEMPLAZA:

Chevrolet: 13427160; **Bosch:** 0 130 308 117

APPLICATION / APLICACIÓN:

CHEVROLET: CRUZE 1.4/1.6/1.8/1.72009>2013, CRUZE Schrägheck 1.4/1.6/1.8/1.7 2011>2013, ORLANDO 1.4/1.8 2011>2012, OPEL: ASTRA J 1.4 turbo /1.6/1.3/2.0 2009>2015, ASTRA J Stufenheck 1.4/1.6/1.3 2012>2016, ASTRA J GTC 1.4/1.6/1.7 2011>2015, ASTRA J Caravan 1.4/1.4 turbo/1.6/1.3/1.7/2.0 2010>2015, CASCADA 1.4/1.4 turbo/1.6 2013>2018, INSIGNIA A 1.4/1.6 2011>2017, INSIGNIA A Stufenheck 1.4/1.6 2011>2017, INSIGNIA A Country Tourer 1.6 2014>2017, INSIGNIA A Sports Tourer 1.4/1.6 2011>2014, ZAFIRA TOURER C 1.4/1.6/2.0 2011>2013

BOSCH



GE1109 // NEW //

FEATURES / CARACTERÍSTICAS

Number of blades / Numero de aspas: 7
Air conditioning / aire acondicionado: With / Aire
PS: With resistance / Con resistencia

REPLACES / REEMPLAZA:

Bosch: F 006 KMO 606; **Chevrolet:** 24431829, 24431830

APPLICATION / APLICACIÓN:

CHEVROLET: Astra 1.7/2.0/2.2 1998>2005, Zafira 2.0/2.0 1999>2005

FORD



GE1110 // NEW //

FEATURES / CARACTERÍSTICAS

Number of blades / Numero de aspas: 7
Motor diameter / Diámetro del motor: 101mm
Rotation direction / Sentido de rotación: Horário
Power / Potencia: 206W
Propeller diameter / Diámetro de la hélice: 339mm
Air conditioning / aire acondicionado: With / Aire
PS: With deflector, similar GE1130 (without deflector) / Con deflector, igual GE1130 (sin deflector)

REPLACES / REEMPLAZA:

Ford: D3B5-8C607-AE, D3B5-8C607-AA, D3B5-8C607-AEM

APPLICATION / APLICACIÓN:

FORD: New Fiesta hatch/sedan 1.5/1.6 8/16V Motor Sigma 2013>, Novo Ka hatch/sedan 1.0/1.5 16V 2014>2018

BOSCH



GE1114 // NEW //

FEATURES / CARACTERÍSTICAS

Number of blades / Numero de aspas: 7

REPLACES / REEMPLAZA:

Bosch: 0 130 303 872, F 006 SA0 305; **Chevrolet:** 52478169

APPLICATION / APLICACIÓN:

CHEVROLET: Vectra 2.0/ 2.2 Elite / 2.2 Elegance 1997>2005

BOSCH



GE1115 // NEW //

FEATURES / CARACTERÍSTICAS

Number of blades / Numero de aspas: 7
Rotation direction / Sentido de rotación: Horário
Power / Potencia: 180W
Propeller diameter / Diámetro de la hélice: 311mm
Aspirate or Blow / Aspira o Sopla: Blow / Sopla

REPLACES / REEMPLAZA:

Bosch: 0 130 303 873

APPLICATION / APLICACIÓN:

AUDI: A6 C6 Allroad 2006>2011

UNIVERSAL



GE1116 // NEW //

FEATURES / CARACTERÍSTICAS:

10 INCHES / 10 PULGADAS
Number of blades / Numero de aspas: 6
Aspirate or Blow / Aspira o Sopla: Aspirate / Aspira

REPLACES / REEMPLAZA:

...

APPLICATION / APLICACIÓN:

UNIVERSAL - 12V

UNIVERSAL
GE1117 // NEW //
FEATURES / CARACTERÍSTICAS:

10 INCHES / 10 PULGADAS
 Number of blades / Numero de aspas: 6
 Aspirate or Blow / Aspira o Sopla: Aspirate / Aspira

REPLACES / REEMPLAZA:

...
APPLICATION / APLICACIÓN:
UNIVERSAL - 24V

RENAULT
GE1126 // NEW //
FEATURES / CARACTERÍSTICAS

Number of blades / Numero de aspas: 6
 Motor diameter / Diámetro del motor: 62mm
 Rotation direction / Sentido de rotación: Clockwise / Horário
 Power / Potencia: 60W
 Propeller diameter / Diámetro de la hélice: 301mm

Aspirate or Blow / Aspira o Sopla: Aspirate / Aspira

REPLACES / REEMPLAZA:

Renault: 7701042439, 7701043975, 7701043977, 7701043979, 7701045216, 7701046627, 7701050677, 7701050678; **Era:** 352102

APPLICATION / APLICACIÓN:

RENAULT: Clio Mk2 hatch 1.2/1.4/1.5/1.6/1.9 1998>2005, Clio Mk2 van 1.5 dCi 2001>, Kangoo Mk1 1.2/1.4/1.5/1.6/1.9 1997>

FORD
GE1127 // NEW //
FEATURES / CARACTERÍSTICAS

Number of blades / Numero de aspas: 7
 Motor diameter / Diámetro del motor: 101mm
 Rotation direction / Sentido de rotación: Horário
 Power / Potencia: 206W
 Propeller diameter / Diámetro de la hélice: 339mm
 Air conditioning / aire acondicionado: With / Aire

PS: with module PWM / Con módulo PWM

REPLACES / REEMPLAZA:

Ford: 3M51-8C607-EC

APPLICATION / APLICACIÓN:

FORD: C-Max 1.6 2007>2010, Focus C-Max 1.6 2003>2007, Focus C-Max 1.6 Ti 2004>2007, Focus Mk2 hatch/saloon/estate 1.4/1.6/1.6 Ti 2004>2012

CHEVROLET
GE1128 // NEW //
FEATURES / CARACTERÍSTICAS

Number of blades / Número de aspas: 11
 Propeller diameter / Diámetro de la hélice: 310mm
 Motor diameter / Diámetro del motor: 103mm
 Rotation direction / Sentido de rotación: Horário
 Power / Potencia: 160W

Air conditioning / Aire acondicionado: With air / con aire

PS: With deflector, condenser air conditioning fan / Con deflector, ventilador del aire acondicionado del condensador

REPLACES / REEMPLAZA:

...

APPLICATION / APLICACIÓN:

CHEVROLET: Tracker 2.0 2001>2009

SUZUKI: Grand Vítara 1998>2012

CITROËN/PEUGEOT
GE1129 // NEW //
FEATURES / CARACTERÍSTICAS

Number of blades / Número de aspas: 7
 Aspirate or Blow / Aspira o Sopla: Blow / Sopla

REPLACES / REEMPLAZA:

Citroën/ Peugeot: 9675280980; **Valeo:** MO848

APPLICATION / APLICACIÓN:

Citroën: C3 I: 1.6 16V/1.4 HDi/ 2002>2010, C3 Ii: 1.0 VTI 68/1.1 i/1.2 VTI 82/1.2 THP 110/1.4/1.4 VTI 95/1.4 LPG/1.6 VTI 120/1.4 HDi 70/1.6 BlueHDi 75/1.6 HDi 90/1.6 HDi/1.6 BlueHDi 100/1.6 HDi 110/1.6 HDi 115/ 2009>2016, C3 Iii: 1.2 VTI 68/1.2 VTI 82/1.2 THP 110/1.6 BlueHDi 75/1.6 BlueHDi 100/ 2016>, C4 Cactus: 1.2 VTI 75 / PureTech 75/1.2 VTI 82/1.2 THP 110/1.2 PureTech 130/1.5 BlueHDi 100/1.6 HDi 90/1.6 BlueHDi 100/ 2014>, Ds3: 1.2 THP 110/1.4 VTI 95/1.4 VTI 95 LPG/1.4 VTI 98/1.6 VTI 120/1.6 THP 155/1.6 THP 165/1.6 Racing/1.6 HDi 90/1.6 BlueHDi 100/1.6 HDi 110/1.6 HDi 115/1.6 BlueHDi 120/ 2009>2015, Ds3 Cabriolet: 1.2 VTI 82/1.6 VTI 120/1.6 THP 155/1.6 THP 165/1.6 HDi 90/1.6 BlueHDi 100/1.6 BlueHDi 120/ 2013>2015, Ds 3: 1.6 THP 165/ 2015>2019, Ds 3 Cabriolet: 1.6 THP 165/ 2015>2019;
Peugeot: 208 I: 1.0/1.2 VTI 68 / PureTech 68/1.2 VTI 82/1.2 GPL/1.2 THP 110/1.4 VTI/1.6/1.6 GTi/1.4 HDi/1.6 HDi / BlueHDi 75/1.6 HDi/1.6 BlueHDi 100/1.6 BlueHDi 120/ 2012>, 2008 I: 1.2 VTI/1.2 THP 110 / PureTech 110/1.6 VTI/1.4 HDi/1.6 BlueHDi 75/1.6 HDi/1.6 BlueHDi 100/1.6 BlueHDi 120/ 2013>2018



FORD

GE1130 // NEW //
FEATURES / CARACTERÍSTICAS

Number of blades / Numero de aspas: 7
 Motor diameter / Diámetro del motor: 101mm
 Rotation Direction / Sentido de rotación: Horário
 Power / Potencia: 206W
 Propeller diameter / Diámetro de la hélice: 339mm
 Air conditioning: with air / Aire acondicionado, con aire
 PS: without deflector, similar GE1110 (with deflector) / sin deflector, igual GE1110 (con deflector)

REPLACES / REEMPLAZA:

Ford: D3B5-8C607-AE, D3B5-8C607-AA, D3B5-8C607-AEM

APPLICATION / APLICACIÓN:

FORD: New Fiesta hatch/sedan 1.5/1.6 8/16V Motor Sigma 2013>, Novo Ka hatch/sedan 1.0/1.5 16V 2014>2018

UNIVERSAL

GE1141
FEATURES / CARACTERÍSTICAS

10" - 12V
 Number of blades / Numero de aspas: 10
 Aspirate or blows / Aspira o sopla

REPLACES / REEMPLAZA:

...

APPLICATION / APLICACIÓN:

UNIVERSAL

UNIVERSAL

GE1142
FEATURES / CARACTERÍSTICAS

10" - 24V
 Number of blades / Numero de aspas: 10
 Aspirate or blows / Aspira o sopla

REPLACES / REEMPLAZA:

...

APPLICATION / APLICACIÓN:

UNIVERSAL

UNIVERSAL

GE1143
FEATURES / CARACTERÍSTICAS

11" - 12V
 Number of blades / Numero de aspas: 10
 Aspirate or blows / Aspira o sopla

REPLACES / REEMPLAZA:

...

APPLICATION / APLICACIÓN:

UNIVERSAL

UNIVERSAL

GE1144
FEATURES / CARACTERÍSTICAS

11" - 24V
 Number of blades / Numero de aspas: 10
 Aspirate or blows / Aspira o sopla

REPLACES / REEMPLAZA:

...

APPLICATION / APLICACIÓN:

UNIVERSAL

UNIVERSAL**GE1145**

FEATURES / CARACTERÍSTICAS

12" - 12V

Number of blades / Numero de aspas: 10

Aspirate or blows / Aspira o sopla

REPLACES / REEMPLAZA:

...

APPLICATION / APLICACIÓN:

UNIVERSAL**UNIVERSAL****GE1146**

FEATURES / CARACTERÍSTICAS

12" - 24V

Number of blades / Numero de aspas: 10

Aspirate or blows / Aspira o sopla

REPLACES / REEMPLAZA:

...

APPLICATION / APLICACIÓN:

UNIVERSAL**UNIVERSAL****GE1147**

FEATURES / CARACTERÍSTICAS

14" - 12V

Number of blades / Numero de aspas: 10

Aspirate or blows / Aspira o sopla

REPLACES / REEMPLAZA:

...

APPLICATION / APLICACIÓN:

UNIVERSAL**UNIVERSAL****GE1148**

FEATURES / CARACTERÍSTICAS

14" - 24V

Number of blades / Numero de aspas: 10

Aspirate or blows / Aspira o sopla

REPLACES / REEMPLAZA:

...

APPLICATION / APLICACIÓN:

UNIVERSAL**UNIVERSAL****GE1149**

FEATURES / CARACTERÍSTICAS

16" - 12V

Number of blades / Numero de aspas: 10

Aspirate or blows / Aspira o sopla

REPLACES / REEMPLAZA:

...

APPLICATION / APLICACIÓN:

UNIVERSAL

UNIVERSAL



GE1150

FEATURES / CARACTERÍSTICAS

16" - 24V

Number of blades / Numero de aspas: 10

Aspirate or blows / Aspira o sopla

REPLACES / REEMPLAZA:

...

APPLICATION / APLICACIÓN:

UNIVERSAL

BOSCH



GE1154 // NEW //

FEATURES / CARACTERÍSTICAS

Number of blades / Numero de aspas: 5

Aspirate or blows / Aspira o sopla: Blow / Sopla

REPLACES / REEMPLAZA:

Bosch: F 006 B10 123; **VW:** 7X0959455A, 7X0 959 455

APPLICATION / APLICACIÓN:

VW: Kombi 2006>2014

VALEO



GE1155 // NEW //

FEATURES / CARACTERÍSTICAS

Number of blades / Numero de aspas: 7

Aspirate or blows / Aspira o sopla: Blow / Sopla

REPLACES / REEMPLAZA:

Valeo: 214819703R, 696886; **Renault:** 214819703R, 214812546R, 214817904R

APPLICATION / APLICACIÓN:

RENAULT: Duster 1.6 / 2.0 16V 2016>, Logan 1.0 / 1.6 8V / 16V 2015>2018, Oroch 1.6 / 2.0 16V 2016>, Sandero 1.0 / 1.6 8V / 16V 2015>2018

UNIVERSAL



GE1156 // NEW //

FEATURES / CARACTERÍSTICAS

Number of blades / Numero de aspas: 4

Aspirate or blows / Aspira o sopla: Aspirate / Aspira

REPLACES / REEMPLAZA:

Bosch: 9 130 081 055; **Fiat:** 75201767; **Lancia:** 75201767, **VW:** 2TJ 959 455

APPLICATION / APLICACIÓN:

UNIVERSAL

TOYOTA



GE1157 // NEW //

FEATURES / CARACTERÍSTICAS

Number of blades / Numero de aspas: 5

Rotation direction / Sentido de rotación: Counter-Clockwise / Antihorario

Power / Potencia: 90W

REPLACES / REEMPLAZA:

Toyota: 163610Y020, 163610Y030, 163610Y080, 163610Y150, 1636328150

APPLICATION / APLICACIÓN:

TOYOTA: CAMRY LE/SE/XLE 4cc 2.4L 2003>2006

RENAULT**GE1158 // NEW //****FEATURES / CARACTERÍSTICAS**

Number of blades / Numero de aspas: 7
Rotation direction / Sentido de rotación: Clockwise / Horário
Motor diameter / Diámetro del motor: 113.45mm
Aspirate or blows / Aspira o sopla: Blow / Sopla

REPLACES / REEMPLAZA:

Renault: 214819703R

APPLICATION / APLICACIÓN:

RENAULT: Duster 1.6 / 2.0 16V 2016>, Logan 1.0 / 1.6 8V / 16V 2015>2018, Oroch 1.6 / 2.0 16V 2016>, Sandero 1.0 / 1.6 8V / 16V 2015>2018



COOLING / AIR CONDITIONING | ENFRIAMIENTO / AIRE ACONDICIONADO

BLOWER | MOTOR DE VENTILADOR INTERNO

BOSCH

GE4000 // NEW //

REPLACES / REEMPLAZA:

BOSCH: F 006 MG0 000

APPLICATION / APLICACIÓN:

VW: Gol, Parati, Saveiro 1.0/ 1.6/ 1.8/ 2.0

RENAULT

GE4001 // NEW //

REPLACES / REEMPLAZA:

RENAULT: 272100975R; **VALEO:** 715251

APPLICATION / APLICACIÓN:

RENAULT: Logan li 1.2 2012>, Logan li 1.2 Lpg 2012>, Logan li 1.5 Dci 2012>, Logan li 1.5 Dci / Blue Dci 75 2012>, Logan li Tce 90 2012>, Logan Mcv li 1.2 2015>, Logan Mcv li 1.2 2013>, Logan Mcv li 1.2 Lpg 2013>, Logan Mcv li 1.5 Dci 2013>, Logan Mcv li Tce 90 2013>, Sandero li 1.0 Sce 75 2016>, Sandero li 1.2 2015>, Sandero li 1.2 2012>, Sandero li 1.2 Lpg 2012>, Sandero li 1.5 Dci 2012>, Sandero li 1.5 Dci 75 / Blue Dci 75 2012>, Sandero li Tce 90 2012>, Sandero li Tce 90 Lpg 2015>

HONDA

GE4002 // NEW //

REPLACES / REEMPLAZA:

HONDA: 79310-sr3-a01

APPLICATION / APLICACIÓN:

HONDA: Civic V Coupé 1.5 l Lsi 1993>1995, Civic V Coupé 1.6 l Vtec 1994>1996, Civic V Hatchback 1.3 16V 1991>1995, Civic V Hatchback 1.5 l 16V 1991>1995, Civic V Hatchback 1.6 16V Vtec 1991>1995, Civic V Hatchback 1.6 Vti 16V 1991>1995, Civic V Sedan 1.5 l 16V 1991>1995, Civic V Sedan 1.6 16V Vtec 1991>1995, Civic V Sedan 1.6 Vti 1991>1995, Civic Vi Aerodeck 1.4 16V 1998>2001, Civic Vi Aerodeck 1.5 16V 1998>2001, Civic Vi Aerodeck 1.6 16V 1998>2001, Civic Vi Aerodeck 1.8 16V 1998>2001, Civic Vi Aerodeck 2.0 l D 1998>2001, Civic Vi Fastback 1.4 l 1995>2001, Civic Vi Fastback 1.5 16V 1997>2001, Civic Vi Fastback 1.5 l Vtec-E 1994>1997, Civic Vi Fastback 1.6 16V 1997>2001, Civic Vi Fastback 1.6 Vti 1997>2001, Civic Vi Fastback 1.6 l 1994>1997, Civic Vi Fastback 1.6 l Vtec 1994>1997, Civic Vi Fastback 1.8 16V 1997>2001, Civic Vi Fastback 2.0 l Td 1997>2001, Civic Vi Hatchback 1.4 l 1995>2001, Civic Vi Hatchback 1.4 l S 1995>2001, Civic Vi Hatchback 1.5 l 1995>2001, Civic Vi Hatchback 1.6 Vti 1995>2001, Civic Vi Hatchback 1.6 l 1995>2001, Civic Vi Sedan 1.4 l 1995>2001, Civic Vi Sedan 1.5 l 1995>2001, Civic Vi Sedan 1.6 Vti 1995>2001, Civic Vi Sedan 1.6 l Vtec 1995>2001

HONDA

GE4003 // NEW //

REPLACES / REEMPLAZA:

HONDA: 79310-S5J-M01

APPLICATION / APLICACIÓN:

HONDA: Civic 2001>2006 - 12V

HONDA

GE4004 // NEW //

REPLACES / REEMPLAZA:

HONDA: 79310-SAD-M01; **BOSCH:** F 006 B10 060

APPLICATION / APLICACIÓN:

HONDA: Fit 2003>2008 - 12 V

HONDA

GE4005 // NEW //

REPLACES / REEMPLAZA:

HONDA: 79310-SNJ-A01; **BOSCH:** F 006 B10 111

APPLICATION / APLICACIÓN:

HONDA: New Civic 2007>2011 - 12 V

FIAT

GE4008 // NEW //

REPLACES / REEMPLAZA:

FIAT: 7088614, 7088222, 7082288; **DENSO:** 5A373030AM

APPLICATION / APLICACIÓN:

FIAT: Palio Weekend 1.9 D 2001>, Palio Weekend 1.9 Jtd 2001>, Strada Pick-Up 1.2 2003>, Strada Pick-Up 1.9 Jtd 2003>

PEUGEOT/CITROËN

GE4009 // NEW //

REPLACES / REEMPLAZA:

PEUGEOT/ CITROËN: 6441RO

APPLICATION / APLICACIÓN:

PEUGEOT: 206, 207;
CITROËN: C3, Picasso Novo

FIAT
GE4010 // NEW //
REPLACES / REEMPLAZA:
FIAT: 7088219

APPLICATION / APLICACIÓN:
FIAT: Palio 1.2 1997>2002, Palio 1.2 1999>2000, Palio Weekend 1.2 1996>2001, Palio Weekend 1.2 2001>, Palio Weekend 1.2 1997>2004, Palio Weekend 1.6 16V 2001>2012, Palio Weekend 1.6 16V 1996>2001, Palio Weekend 1.7 Td 1996>2001, Palio Weekend 1.9 D 2001>, Palio Weekend 1.9 Jtd 2001>, Strada Pick-Up 1.2 2003>, Strada Pick-Up 1.2 1999>2006, Strada Pick-Up 1.3 D Multijet 2006>, Strada Pick-Up 1.7 Td 1999>2006, Strada Pick-Up 1.9 D 2000>, Strada Pick-Up 1.9 Jtd 2003>

RENAULT
GE4011 // NEW //
REPLACES / REEMPLAZA:
RENAULT: 6001552011, 6001552012;

MAGNETI MARELLI: FA971001MM

APPLICATION / APLICACIÓN:
RENAULT: Logan 2008>, Sandero 2008>

VW
GE4012 // NEW //
REPLACES / REEMPLAZA:
VW: 2H1 820 021, 17771BA11

APPLICATION / APLICACIÓN:
VW: Amarok 2010>

RENAULT
GE4013 // NEW //
REPLACES / REEMPLAZA:
RENAULT: 7702295103

APPLICATION / APLICACIÓN:
RENAULT: Scenic 1.6/2.0 1999>2009

VW
GE4015 // NEW //
REPLACES / REEMPLAZA:
VW: 2R2 819 015

APPLICATION / APLICACIÓN:
VW: CONSTELLATION (All) - 24V

BOSCH
GE4021 // NEW //
REPLACES / REEMPLAZA:
BOSCH: 9 130 081 021

APPLICATION / APLICACIÓN:
AGRALE-DEUTZ: 1800 D 1988>1998 GM: Ipanema 1.8 1989>1991, Ipanema 2.0 1989>1991, Kadett 1.8 1989>1991, Kadett 2.0 1991>1997, Kadett GS 2.0 1989>1995, Monza 1.6 1984>1986, Monza 1.8 1984>1991, Monza 2.0 1986>1991, Monza Hatch 1.6 1982>1986, Monza Hatch 1.8 1984>1988, Monza Hatch 2.0 1987>1988

PEUGEOT/CITROËN
GE4024 // NEW //
REPLACES / REEMPLAZA:
PEUGEOT/ CITROËN: 6441S6;

MEAT & DORIA: 6441S6

APPLICATION / APLICACIÓN:
CITROËN: C4 Coupé 1.4 16V 2004>2011, C4 Coupé 1.6 16V 2004>2011, C4 Coupé 1.6 Hdi 2004>2011, C4 Coupé 1.6 Thp 150 2008>2011, C4 Coupé 1.6 Vti 120 2008>2011, C4 Coupé 2.0 16V 2004>2007, C4 Coupé 2.0 16V 2004>2010, C4 Coupé 2.0 Hdi 2004>2010, C4 Coupé 2.0 Hdi 2008>2011, C4 I 1.4 16V 2004>2011, C4 I 1.6 16V 2004>2011, C4 I 1.6 Hdi 2004>2011, C4 I 1.6 Thp 140 2008>2011, C4 I 1.6 Thp 150 2008>2011, C4 I 1.6 Vti 120 2008>2011, C4 I 2.0 16V 2004>2007, C4 I 2.0 16V 2004>2011, C4 I 2.0 16V 2004>2008, C4 I 2.0 Hdi 2004>2011, C4 I 2.0 Hdi 2008>2011, PEUGEOT: 307 1.4 16V 2003>2007, 307 1.6 16V 2000>2007, 307 1.6 Hdi 2005>2009, 307 1.6 Hdi 110 2004>2009, 307 2.0 16V 2005>2007, 307 2.0 Hdi 135 2003>2007, 307 Break 1.4 16V 2003>2007, 307 Break 1.6 16V 2002>2008, 307 Break 1.6 Hdi 2005>2008, 307 Break 1.6 Hdi 110 2004>2008, 307 Break 2.0 16V 2005>2008, 307 Break 2.0 Hdi 135 2004>2008, 307 Cc 1.6 16V 2003>2009, 307 Cc 2.0 16V 2004>2009, 307 Cc 2.0 16V 2003>2009, 307 Cc 2.0 Hdi 135 2005>2009, 307 Sw 1.4 16V 2003>2007, 307 Sw 1.6 16V 2002>2008, 307 Sw 1.6 Hdi 110 2003>2007, 307 Sw 2.0 16V 2005>2008, 307 Sw 2.0 Hdi 135 2004>2008

FIAT
GE4040 // NEW //
REPLACES / REEMPLAZA:
FIAT: K410003R

APPLICATION / APLICACIÓN:
FIAT: Tipo (with air conditioning)

TOYOTA
GE4041 // NEW //

REPLACES / REEMPLAZA:

TOYOTA: 2727008041

APPLICATION / APLICACIÓN:

TOYOTA: Rav4 2006>2016

BOSCH
GE4047 // NEW //

REPLACES / REEMPLAZA:

BOSCH: 9 130 081 047

APPLICATION / APLICACIÓN:

MERCEDES-BENZ: Bus O370 R, RS E RSD, 371R, RS, RSD - 24 V

BOSCH
GE4049 // NEW //

REPLACES / REEMPLAZA:

BOSCH: 9 130 451 049; **MERCEDES BENZ:** A 386 830 70 08; **IMOBRA:** 101100124

APPLICATION / APLICACIÓN:

MERCEDES-BENZ: L 2635 1992>2002, LS 1625 1990>2000, LS 1630 1990>2000, LS 1935 1990>2005, LS 1941 1990>2000, O 370 RS 1984>1994, O 371 UL 1993>2003, O 400 R 1993>2003, O 400 RS 1992>2002, O 400 RSD 1992>2002, O 400 RSL 1992>2002

GM
GE4067 // NEW //

REPLACES / REEMPLAZA:

GM: 90376564, 93242359; **DELCO:** 18080670;

SIEMENS: 1BB52

APPLICATION / APLICACIÓN:

GM: Omega 2.0/2.0/3.0 1992>1998

BOSCH
GE4068 // NEW //

REPLACES / REEMPLAZA:

BOSCH: 9 130 451 068

APPLICATION / APLICACIÓN:

MERCEDES-BENZ: Bus O371 R, RS, RSD, O371 U, UP - 24 V

BOSCH
GE4074 // NEW //

REPLACES / REEMPLAZA:

BOSCH: 9 130 451 074

APPLICATION / APLICACIÓN:

FIAT: Uno 1.1 1988>1989, Uno 1.4 1994>1995, Uno 1.5 1987>1993, Uno 1.6 1989>1993, Uno 1050 1984>1985, Uno 1300 1984>1991, Uno Furgoneta 1.3 2004>0, Uno Furgoneta 1.5 1997>2004, Uno Mille 1.0 1990>1993, Uno Mille Electronic 1.0 1993>1995

DENSO
GE4084 // NEW //

REPLACES / REEMPLAZA:

DENSO: AY272700-8084; **TOYOTA:** 8710302330

APPLICATION / APLICACIÓN:

TOYOTA: Corolla 2014>2015

VW
GE4102 // NEW //

REPLACES / REEMPLAZA:

VW: 1J1819021, 1J1819021A, 1J1819021B, 1J1819021C; **VALEO:** 698262

APPLICATION / APLICACION:

AUDI: A3 1.6 1996>2003, A3 1.6 2000>2003, A3 1.8 1996>2003, A3 1.8 T 1996>2003, A3 1.8 T 1998>2003, A3 1.8 T Quattro 1996>2003, A3 1.8 T Quattro 1998>2003, A3 1.9 Tdi 1996>2001, A3 1.9 Tdi 2000>2003, A3 1.9 Tdi 1997>2001, A3 1.9 Tdi Quattro 2000>2003, A3 S3 Quattro 1999>2002, A3 S3 Quattro 2001>2003, Tt 1.8 T 2002>2006, Tt 1.8 T 2005>2006, Tt 1.8 T 1998>2006, Tt 1.8 T Quattro 1998>2006, Tt 1.8 T Quattro 2005>2006, Tt 3.2 V6 Quattro 2003>2006, Tt Roadster 1.8 T 2001>2006, Tt Roadster 1.8 T 1999>2006, Tt Roadster 1.8 T 2005>2006, Tt Roadster 1.8 T Quattro 2000>2006, Tt Roadster 1.8 T Quattro 2005>2006, Tt Roadster 1.8 T Quattro 1999>2006, Tt Roadster 3.2 V6 Quattro 2003>2006, SEAT: Arosa 1.0 1997>2004, Arosa 1.4 1997>2004, Arosa 1.4 16V 2000>2004, Arosa 1.4 Tdi 2000>2004, Arosa 1.7 Sdi 1997>2004, Cordoba 1.4 16V 2000>2002, Cordoba 1.8 T 20V Cupra 2000>2002, Cordoba 1.9 Sdi 1999>2002, Cordoba Vario 1.4 16V 1999>2002, Cordoba Vario 1.9 Sdi 1999>2002, Ibiza li 1.4 16V 2000>2002, Ibiza li 1.8 T 20V Cupra 2000>2002, Ibiza li 1.9 Sdi 1999>2002, Leon 1.4 16V 1999>2006, Leon 1.6 1999>2006, Leon 1.6 16V 2000>2006, Leon 1.8 20V 1999>2006, Leon 1.8 20V T 1999>2006, Leon 1.8 20V T 4 1999>2006, Leon 1.8 T Cupra R 2002>2006, Leon 1.8 T Cupra R 2003>2006, Leon 1.9 Sdi 1999>2006, Leon 1.9 Tdi 1999>2006, Leon 1.9 Tdi 2003>2006, Leon 1.9 Tdi 2000>2006, Leon 1.9 Tdi Syncro 2002>2006, Leon 2.8 Cupra 4 2001>2006, Toledo li 1.4 16V 2000>2002, Toledo li 1.6 1998>2004, Toledo li 1.6 16V 2000>2006, Toledo li 1.8 20V 1998>2004, Toledo li 1.8 20Vt 2000>2004, Toledo li 1.9 Tdi 1999>2004, Toledo li 1.9 Tdi 1998>2004, Toledo li 1.9 Tdi 2003>2006, Toledo li 1.9 Tdi 2000>2004, Toledo li 2.3 V5 1998>2000, Toledo li 2.3 V5 20V 2000>2003, SKODA: Octavia I 1.4 1999>2001, Octavia I 1.4 16V 2000>2010, Octavia I 1.6 1996>2004, Octavia I 1.6 1997>2007, Octavia I 1.6 2000>2010, Octavia I 1.8 1996>2000, Octavia I 1.8 T 1997>2010, Octavia I 1.8 T 4X4 2001>2006, Octavia I 1.9 Sdi 1997>2003, Octavia I 1.9 Sdi 1996>2010, Octavia I 1.9 Tdi 1996>2010, Octavia I 1.9 Tdi 1997>2006, Octavia I 1.9 Tdi 2002>2004, Octavia I 2.0 1999>2007, Octavia I Rs 1.8 T 2001>2006, Octavia I Combi 1.4 16V 2000>2010, Octavia I Combi 1.6 1998>2004, Octavia I Combi 1.6 1998>2007, Octavia I Combi 1.6 2000>2010, Octavia I Combi 1.8 20V 1998>2000, Octavia I Combi 1.8 T 1998>2010, Octavia I Combi 1.8 T 4X4 2001>2006, Octavia I Combi 1.9 Sdi 1998>2003, Octavia I Combi 1.9 Tdi 1998>2010, Octavia I Combi 1.9 Tdi 2000>2010, Octavia I Combi 1.9 Tdi 1998>2006, Octavia I Combi 1.9 Tdi 2002>2004, Octavia I Combi 1.9 Tdi 4X4 1999>2006, Octavia I Combi 1.9 Tdi 4X4 2000>2006, Octavia I Combi 2.0 1999>2007, Octavia I Combi 2.0 4X4 2000>2004, Octavia I Combi Rs 1.8 T 2002>2006;

VW: Bora 1.4 16V 2000>2005, Bora 1.6 1998>2005, Bora 1.6 2000>2005, Bora 1.6 16V 2000>2005, Bora 1.6 Fsi 2002>2005, Bora 1.8 1998>2005, Bora 1.8 4Motion 1999>2005, Bora 1.8 T 2000>2005, Bora 1.8 T 2002>2005, Bora 1.9 Sdi 1998>2005, Bora 1.9 Tdi 1998>2005, Bora 1.9 Tdi 2000>2005, Bora 1.9 Tdi 1998>2001, Bora 1.9 Tdi 1998>2002, Bora 1.9 Tdi 4Motion 1998>2002, Bora 1.9 Tdi 4Motion 2000>2005, Bora 1.9 Tdi 4Motion 1999>2001, Bora 2.0 1998>2013, Bora 2.0 4Motion 2000>2005, Bora 2.3 V5 1998>2000, Bora 2.3 V5 2000>2005, Bora 2.3 V5 4Motion 1998>2000, Bora 2.3 V5 4Motion 2000>2005, Bora 2.8 V6 4Motion 1999>2005, Bora Variant 1.4 16V 2001>2005, Bora Variant 1.6 1999>2005, Bora Variant 1.6 2000>2005, Bora Variant 1.6 16V 2000>2005, Bora Variant 1.6 Fsi 2002>2005, Bora Variant 1.8 4Motion 1999>2005, Bora Variant 1.8 T 2000>2005, Bora Variant 1.8 T 2002>2005, Bora Variant 1.9 Tdi 2004>2005, Bora Variant 1.9 Tdi 2000>2005, Bora Variant 1.9 Tdi 1999>2001, Bora Variant 1.9 Tdi 2001>2005, Bora Variant 1.9 Tdi 4Motion 2000>2005, Bora Variant 1.9 Tdi 4Motion 1999>2001, Bora Variant 1.9 Tdi 4Motion 2001>2005, Bora Variant 2.0 1999>2005, Bora Variant 2.0 4Motion 2000>2005, Bora Variant 2.3 V5 1999>2000, Bora Variant 2.3 V5 2000>2005, Bora Variant 2.3 V5 4Motion 1999>2000, Bora Variant 2.3 V5 4Motion 2000>2005, Bora Variant 2.8 V6 4Motion 1999>2005, Golf Iv 1.4 16V 1997>2004, Golf Iv 1.6 1997>2004, Golf Iv 1.6 2000>2005, Golf Iv 1.6 16V 2000>2005, Golf Iv 1.6 Fsi 2002>2005, Golf Iv 1.8 1997>2005, Golf Iv 1.8 4Motion 1998>2005, Golf Iv 1.8 T 1997>2005, Golf Iv 1.8 T Gti 2001>2005, Golf Iv 1.9 Sdi 1997>2005, Golf Iv 1.9 Tdi 1997>2004, Golf Iv 1.9 Tdi 2000>2005, Golf Iv 1.9 Tdi 1998>2001, Golf Iv 1.9 Tdi 4Motion 1998>2002, Golf Iv 1.9 Tdi 4Motion 2000>2005, Golf Iv 1.9 Tdi 4Motion 1999>2001, Golf Iv 2.0 1998>2004, Golf Iv 2.0 4Motion 2000>2005, Golf Iv 2.3 V5 1997>2000, Golf Iv 2.3 V5 2000>2005, Golf Iv 2.3 V5 4Motion 1998>2000, Golf Iv 2.3 V5 4Motion 2000>2005, Golf Iv 2.8 V6 4Motion 1999>2005, Golf Iv 3.2 R32 4Motion 2002>2005, Golf Iv Variant 1.4 16V 1999>2006, Golf Iv Variant 1.6 1999>2002, Golf Iv Variant 1.6 2000>2006, Golf Iv Variant 1.6 16V 2000>2006, Golf Iv Variant 1.6 Fsi 2002>2006, Golf Iv Variant 1.8 4Motion 1999>2006, Golf Iv Variant 1.8 T 2000>2006, Golf Iv Variant 1.9 Sdi 1999>2006, Golf Iv Variant 1.9 Tdi 1999>2006, Golf Iv Variant 1.9 Tdi 2000>2006, Golf Iv Variant 1.9 Tdi 1999>2001, Golf Iv Variant 1.9 Tdi 4Motion 1999>2002, Golf Iv Variant 1.9 Tdi 4Motion 2000>2006, Golf Iv Variant 1.9 Tdi 4Motion 1999>2001, Golf Iv Variant 2.0 1999>2006, Golf Iv Variant 2.0 4Motion 2000>2006, Golf Iv Variant 2.0 Bi-Fuel 2002>2006, Golf Iv Variant 2.3 V5 1999>2006, Golf Iv Variant 2.3 V5 2000>2006, Golf Iv Variant 2.3 V5 4Motion 1999>2006, Golf Iv Variant 2.3 V5 4Motion 2000>2006, Golf Iv Variant 2.8 V6 4Motion 1999>2006, Lupo 1.0 1998>2000, Lupo 1.0 1998>2005, Lupo 1.2 Tdi 3L 1999>2005, Lupo 1.4 2000>2005, Lupo 1.4 16V 1998>2005, Lupo 1.4 16V 1999>2005, Lupo 1.4 Fsi 2001>2005, Lupo 1.4 Tdi 1999>2005, Lupo 1.6 Gti 2000>2005, Lupo 1.7 Sdi 1998>2005, New Beetle 1.4 2001>2010, New Beetle 1.6 1999>2000, New Beetle 1.6 2000>2010, New Beetle 1.8 T 1999>2010, New Beetle 1.8 T 2001>2005, New Beetle 1.9 Tdi 1998>2004, New Beetle 1.9 Tdi 2001>2010, New Beetle 1.9 Tdi 2005>2010, New Beetle 2.0 1998>2010, New Beetle 2.3 V5 2000>2010, New Beetle Rsi 3.2 4Motion 2000>2001, New Beetle Conversivel 1.4 2003>2010, New Beetle Conversivel 1.6 2003>2010, New Beetle Conversivel 1.8 T 2003>2010, New Beetle Conversivel 1.9 Tdi 2003>2010, New Beetle Conversivel 1.9 Tdi 2005>2010, New Beetle Conversivel 2.0 2002>2010, New Beetle Conversivel 2.5 2005>2010, Polo 1.0 1999>2001, Polo 1.4 1999>2001, Polo 1.4 16V 1999>2001, Polo 1.4 Tdi 1999>2001, Polo 1.6 16V Gti 1999>2001, Polo 1.7 Sdi 1999>2001, Polo 1.9 D 1999>2001, Polo 1.9 Sdi 1999>2001, Polo Classic 100 1.6 1995>2001, Polo Classic 110 1.9 Tdi 1998>2002, Polo Classic 60 1.4 1995>2001, Polo Classic 68 1.9 Sdi 1999>2002, Polo Classic 75 1.4 16V 1999>2001, Polo Classic 75 1.6 1995>2001, Polo Classic 90 1.8 1997>2001, Polo Classic 90 1.9 Tdi 1996>2001, Polo Variant 1.4 1997>2001, Polo Variant 1.4 16V 1999>2001, Polo Variant 1.6 1997>2001, Polo Variant 1.9 Sdi 1999>2001, Polo Variant 1.9 Tdi 1997>2001, Polo Variant 1.9 Tdi 1998>2001

BOSCH
GE4103 // NEW //

REPLACES / REEMPLAZA:

BOSCH: F 006 MG0 303

APPLICATION / APLICACION:

VW: Gol, Parati, Saveiro G3/ G4 - without air conditioning 1999> 12V

MERCEDES BENZ
GE4108 // NEW //

REPLACES / REEMPLAZA:

MERCEDES BENZ: A0038300108, 0038300108, A003830010864

APPLICATION / APLICACIÓN:

MERCEDES-BENZ: Atego 2 1418 2004>, Atego 2 1418 K 2011>, Atego 2 1419 2004>, Atego 2 1518 A 2004>, Atego 2 1518 Ak 2004>, Atego 2 1518 K 2004>, Atego 2 1518, 1518 L 2004>, Atego 2 1522 A 2004>, Atego 2 1522 Af 2004>, Atego 2 1522 Ak 2004>, Atego 2 1522 F 2004>, Atego 2 1522 K 2004>, Atego 2 1522, 1522 L 2004>, Atego 2 1523 A, 1524 A 2004>, Atego 2 1523 K, 1524 K 2004>, Atego 2 1523, 1523 L, 1524, 1524 L 2004>, Atego 2 1524 Ak 2004>, Atego 2 1524, 1524 L 2004>, Atego 2 1526 Af 2004>, Atego 2 1526 Ak 2004>, Atego 2 1526 K 2004>, Atego 2 1526, 1526 L 2004>, Atego 2 1528, 1528 L, 1529, 1529 L 2004>, Atego 2 1529 Af 2004>, Atego 2 1529 Ak 2004>, Atego 2 1529 F 2004>, Atego 2 1529 K 2004>, Atego 2 1529, 1529 L 2004>, Atego 2 1618 2004>, Atego 2 1618 K 2004>, Atego 2 1622 2004>, Atego 2 1622 K 2004>, Atego 2 1624 2004>, Atego 2 1624 K 2004>, Atego 2 1629 2004>, Atego 2 1718 2004>, Atego 2 1718 K 2011>, Atego 2 1719 2004>, Atego 2 1722 2004>, Atego 2 1725 2004>, Atego 2 1725 A 2006>, Atego 2 1725 K 2011>, Atego 2 1725 S 2007>, Atego 2 1726 A 2011>, Atego 2 1726, 1728 2011>, Atego 2 1728 2007>, Atego 2 1728 S 2007>, Atego 2 1729 2012>, Atego 2 1729 S 2012>, Atego 2 1924 L 2004>, Atego 2 1926 L 2004>, Atego 2 1929 L 2004>, Atego 2 2224 L 2004>, Atego 2 2226 L 2004>, Atego 2 2229 L 2004>, Atego 2 2422 2004>, Atego 2 2425 2004>, Atego 2 2426 2012>, Atego 2 2428 2004>, Atego 2 2429, 2430 2012>, Atego 2 2529 L 2004>, Atego 3 1518 A 2013>, Atego 3 1518 K 2013>, Atego 3 1518, 1518 L 2013>, Atego 3 1521 A 2013>, Atego 3 1521 Ak 2013>, Atego 3 1521 K 2013>, Atego 3 1521, 1521 L 2013>, Atego 3 1523 A 2013>, Atego 3 1523 Ak 2013>, Atego 3 1523 K 2013>, Atego 3 1523, 1523 L 2013>, Atego 3 1524 A 2013>, Atego 3 1524 Ak 2013>, Atego 3 1524 K 2013>, Atego 3 1524, 1524 L 2013>, Atego 3 1527 Af 2013>, Atego 3 1527 Ak 2013>, Atego 3 1527 F 2013>, Atego 3 1527 K 2013>, Atego 3 1527, 1527 L 2013>, Atego 3 1530 Af 2013>, Atego 3 1530 Ak 2013>, Atego 3 1530 F 2013>, Atego 3 1530 K 2013>, Atego 3 1530, 1530 L 2013>, Axor 1823 2002>2004, Axor 1823 K 2002>2004, Axor 2 1823 Ak, 1824 Ak 2004>, Axor 2 1823 K, 1823 Kl, 1824 K 2004>, Axor 2 1823 Ls, 1824 Ls 2004>, Axor 2 1823, 1823 L, 1824, 1824 L, Ll 2004>, Axor 2 1824 A 2004>, Axor 2 1826 Ak 2004>, Axor 2 1826 K 2004>, Axor 2 1826 Ls 2004>, Axor 2 1826, 1826 L, Ll 2004>, Axor 2 1828 A, 1829 A 2004>, Axor 2 1828 Ak, 1829 Ak 2004>, Axor 2 1828 K, 1828 Kl, 1829 K 2004>, Axor 2 1828 Ls 2004>, Axor 2 1828, 1828 L, 1829, 1829 L, Ll 2004>, Axor 2 1829 Ls 2004>, Axor 2 1833 A 2004>, Axor 2 1833 Ak 2004>, Axor 2 1833 K 2004>, Axor 2 1833 Ls 2004>, Axor 2 1833, 1833 L, Ll 2004>, Axor 2 1835 Ls 2011>, Axor 2 1836 Ls, Lls 2004>, Axor 2 1840 Ls, Lls 2004>, Axor 2 1843 Ls, Lls 2004>, Axor 2 1933 2004>, Axor 2 1933 S 2011>, Axor 2 2035 S, 2036 S, Ls 2011>, Axor 2 2040 S, 2041 S, 2041 Ls 2011>, Axor 2 2044 S 2011>, Axor 2 2436 Ls, 2536 Ls 2004>, Axor 2 2440 Ls, 2540 Ls 2004>, Axor 2 2443 Ls, 2543 Ls 2004>, Axor 2 2523 2011>, Axor 2 2528 K, 2528 Kl 2011>, Axor 2 2528 L, 2529 L 2004>, Axor 2 2533, 2533 L 2004>, Axor 2 2535 L, 2536 L, 2536 Ll 2004>, Axor 2 2535 S, 2535 Ls 2004>, Axor 2 2540 L, Ll 2004>, Axor 2 2540 S, 2541 S, Ls 2004>, Axor 2 2543 L, Ll 2004>, Axor 2 2543 S, 2543 Ls 2004>, Axor 2 2544 S, 2544 Ls 2004>, Axor 2 2628 B, 2629 B 2004>, Axor 2 2628 K, 2629 K 2004>, Axor 2 2628, 2629 2004>, Axor 2 2633 2004>, Axor 2 2633 B 2004>, Axor 2 2633 K 2004>, Axor 2 2635 B 2005>, Axor 2 2636 2004>, Axor 2 2636 B 2004>, Axor 2 2636 K 2004>, Axor 2 2640 2004>, Axor 2 2640 B 2004>, Axor 2 2640 K 2004>, Axor 2 2640 S, 2641 S, Ls 2004>, Axor 2 2643 2004>, Axor 2 2643 B 2004>, Axor 2 2643 K 2004>, Axor 2 2644 S, Ls 2011>, Axor 2 2828 K 2004>, Axor 2 2831 2011>, Axor 2 2831 K 2011>, Axor 2 3028 B 2011>, Axor 2 3028 K 2011>, Axor 2 3131 2011>, Axor 2 3131 K 2011>, Axor 2 3228 2011>, Axor 2 3235 2004>, Axor 2 3236 B 2004>, Axor 2 3236 K 2004>, Axor 2 3240 2005>, Axor 2 3240 B 2004>, Axor 2 3240 K 2004>, Axor 2 3243 2004>, Axor 2 3243 B 2004>, Axor 2 3243 K 2004>, Axor 2 3335 2004>, Axor 2 3335 B 2004>2005, Axor 2 3335 K 2009>, Axor 2 3335 S 2008>, Axor 2 3340 B 2004>2005, Axor 2 3340 K, 3341 K 2004>, Axor 2 3340 S, 3341 S 2009>, Axor 2 3340, 3341 2004>, Axor 2 3343 2004>, Axor 2 3343 B 2004>, Axor 2 3343 K 2011>, Axor 2 3343 S 2011>, Axor 2 3344 2004>, Axor 2 3344 K 2011>, Axor 2 3344 K 2004>, Axor 2 3344 S 2004>, Axor 2 3535 K 2009>, Axor 2 4135 B 2005>, Axor 2 4135 K 2009>, Axor 2 4140 2011>, Axor 2 4140 B 2011>, Axor 2 4140 K 2009>, Axor 2 4141 K 2011>, Axor 2 4143 B 2011>, Axor 2 4143 K 2011>, Axor 2 4143 K 2009>, Axor 2 4144 2011>, Axor 2 4144 K 2004>, Axor 2523 2002>2004, Axor 2523 K 2002>2004, Axor 2623 L 2002>2004, Axor 2628 B 2002>2004, Axor 2628 K 2002>2004, Axor 2628 L 2002>2004, Axor 3228 C 2002>2004, Zetros 1833 A 2008>, Zetros 2733 A 2008>

VALEO
GE4118 // NEW //

REPLACES / REEMPLAZA:

VALEO: 22136118; **GM:** 52498981, 52460752

APPLICATION / APLICACIÓN:

GM: S-10 2.2 1996>2004, Blazer 2.2 1996>2012

VALEO
GE4119 // NEW //

REPLACES / REEMPLAZA:

VALEO: 22136119; **GM:** 52463950

APPLICATION / APLICACIÓN:

GM: S-10 2.2 1995>2011, Blazer 2.2 1996>2012

GM
GE4137 // NEW //

REPLACES / REEMPLAZA:

GM: 94767137

APPLICATION / APLICACIÓN:

GM: Onix 2013>2015, Prisma 2013>2015, Cobalt 2012>2015, Spin 2013>2014 - 12V

TOYOTA
GE4142 // NEW //

REPLACES / REEMPLAZA:

TOYOTA: AE4011

APPLICATION / APLICACIÓN:

TOYOTA: Etios 2014>

BOSCH
GE4143 // NEW //

REPLACES / REEMPLAZA:

BOSCH: 9 130 451 143

APPLICATION / APLICACIÓN:

VW: Gol II, Parati II, Saveiro II, Gol III, Parati III, Saveiro III - without air conditioning - 12V

BOSCH
GE4184 // NEW //

REPLACES / REEMPLAZA:

BOSCH: 0 130 111 184; **SCANIA:** 1357713, 1401436, 1495692

APPLICATION / APLICACIÓN:

SCANIA: 4 - Series 114 C/340 1998>2008, 4 - Series 114 C/340 1996>2008, 4 - Series 114 C/380 1998>2008, 4 - Series 114 G/340 1996>2008, 4 - Series 114 G/340 1998>2008, 4 - Series 114 G/380 1998>2008, 4 - Series 114 L/340 1998>2008, 4 - Series 114 L/340 1996>2006, 4 - Series 114 L/340 1996>2008, 4 - Series 114 L/340 1996>2004, 4 - Series 114 L/380 1998>2008, 4 - Series 114 L/380 1996>2004, 4 - Series 124 /G420 1996>2008, 4 - Series 124 C/360 1996>1999, 4 - Series 124 C/360 1996>2008, 4 - Series 124 C/400 1996>2008, 4 - Series 124 C/420 1996>2008, 4 - Series 124 C/420 2000>2004, 4 - Series 124 C/470 2000>2008, 4 - Series 124 G/360 1996>2008, 4 - Series 124 G/400 1996>2008, 4 - Series 124 G/420 1996>2008, 4 - Series 124 G/470 1999>2004, 4 - Series 124 G/470 2000>2008, 4 - Series 124 L/360 1996>2008, 4 - Series 124 L/400 1996>2008, 4 - Series 124 L/420 1996>2008, 4 - Series 124 L/420 1997>2008, 4 - Series 124 L/440 2001>2008, 4 - Series 124 L/470 2001>2008, 4 - Series 124 L/470 2000>2008, 4 - Series 124 L/470 1999>2004, 4 - Series 144 C/460 1996>2008, 4 - Series 144 C/530 1996>2008, 4 - Series 144 G/460 1996>2008, 4 - Series 144 G/530 1996>2008, 4 - Series 144 L/460 1995>2008, 4 - Series 144 L/530 1995>2008, 4 - Series 144 L/530 2000>2008, 4 - Series 94 /G260 1996>2008, 4 - Series 94 C/220 1996>1999, 4 - Series 94 C/260 1996>2008, 4 - Series 94 C/260 1996>2004, 4 - Series 94 C/300 1999>2004, 4 - Series 94 C/300 1996>2008, 4 - Series 94 C/310 1996>2008, 4 - Series 94 C/310 1996>1999, 4 - Series 94 D/220 1996>2008, 4 - Series 94 D/230 1999>2008, 4 - Series 94 D/260 1996>2008, 4 - Series 94 D/300 1996>2008, 4 - Series 94 D/310 1996>2008, 4 - Series 94 D/310 1998>2008, 4 - Series 94 G/220 1998>2008, 4 - Series 94 G/220 1996>2008, 4 - Series 94 G/230 1998>2004, 4 - Series 94 G/260 1996>2008, 4 - Series 94 G/260 1996>2004, 4 - Series 94 G/260 1998>2008, 4 - Series 94 G/300 1999>2004, 4 - Series 94 G/310 1996>1999, 4 - Series 94 G/310 1996>2008, 4 - Series 94 L/260 1996>2004, 4 - Series 94 L/300 1999>2004, 4 - Series 94 L/310 1996>2008, 4 - Series T 114 C/340 1998>2008, 4 - Series T 114 C/340 1996>2008, 4 - Series T 114 C/380 1998>2008, 4 - Series T 114 G/340 1998>2008, 4 - Series T 114 G/340 1996>2008, 4 - Series T 114 G/380 1998>2008, 4 - Series T 114 L/340 1998>2008, 4 - Series T 114 L/340 1996>2008, 4 - Series T 114 L/380 1998>2008, 4 - Series T 124 C/360 1995>2008, 4 - Series T 124 C/400 1996>2008, 4 - Series T 124 C/420 1996>2008, 4 - Series T 124 C/420 1997>2008, 4 - Series T 124 G/360 1997>2008, 4 - Series T 124 G/400 1997>2008, 4 - Series T 124 G/420 1997>2008, 4 - Series T 124 G/420 1996>2008, 4 - Series T 124 L/360 1997>2008, 4 - Series T 124 L/360 1995>2008, 4 - Series T 124 L/400 1997>2008, 4 - Series T 124 L/400 1996>2008, 4 - Series T 124 L/420 1997>2008, 4 - Series T 124 L/420 1996>2008, 4 - Series T 124 L/470 2000>2008, 4 - Series T 124 L/470 2001>2008, 4 - Series T 144 C/460 1995>2008, 4 - Series T 144 C/530 1995>2008, 4 - Series T 144 G/460 1997>2008, 4 - Series T 144 G/530 1997>2008, 4 - Series T 144 L/460 1997>2008, 4 - Series T 144 L/460 1995>2008, 4 - Series T 144 L/530 1997>2008, 4 - Series T 144 L/530 1995>2008, 4 - Series T 94 C/260 1996>2008, 4 - Series T 94 C/310 1996>2008, 4 - Series T 94 G/220 1996>2008, 4 - Series T 94 G/230 1999>2008, 4 - Series T 94 G/260 1996>2008, 4 - Series T 94 G/310 1996>2008, 4 - Series T 94 L/310 1996>2008, P,G,R,T - Series P 230 2004>, P,G,R,T - Series P 260 2004>

DENSO
GE4190 // NEW //

REPLACES / REEMPLAZA:

DENSO: 46722956, 141730600; **FIAT:** 71735484; **VALEO:** 698534; **MAGNETI MARELLI:** 069412504010

APPLICATION / APLICACIÓN:

FIAT: Doblò MPV 2001>, Doblò Cargo Van 2000>, Punto Hatch (MK2) 1999>2012, Punto Van (MK2) 2000>2010

BOSCH
GE4222 // NEW //

REPLACES / REEMPLAZA:

BOSCH: 9 130 451 222

APPLICATION / APLICACIÓN:

MERCEDES BENZ: Trucks 12V

BOSCH
GE4223 // NEW //

REPLACES / REEMPLAZA:

BOSCH: 9 130 451 223

APPLICATION / APLICACIÓN:

MERCEDES BENZ: Trucks 24V

TOYOTA
GE4230 // NEW //

REPLACES / REEMPLAZA:

TOYOTA: 87103-0K230;

DENSO: 116340-7891, 272700-5152

APPLICATION / APLICACIÓN:

TOYOTA: Hilux 2005>

BOSCH
GE4302 // NEW //

REPLACES / REEMPLAZA:

BOSCH: F 006 MG0 302; **FORD:** 96FW18565AA, 1003943, 1049623, 1055062, 1E0361B10C, 96FW18565AA, 96FW18565AE; **MAZDA:** 1E03-61-B10C

APPLICATION / APLICACIÓN:

FORD: Courier Furgão 1.3 1991>1996, Courier Furgão 1.3 1996>2003, Courier Furgão 1.4 I 1996>1999, Courier Furgão 1.8 D 1996>2002, Courier Furgão 1.8 Di 2000>2003, Fiesta Furgão D 1.8 1998>2002, Fiesta Furgão Td 1.8 2000>2003, Fiesta Iv 1.25 I 16V 1995>2002, Fiesta Iv 1.3 I 1995>2002, Fiesta Iv 1.4 I 16V 1996>2002, Fiesta Iv 1.6 16V Sport 2000>2002, Fiesta Iv 1.8 D 1995>2000, Ka 1.3 I 1996>2002, Ka 1.3 I 1996>2008, Ka 1.3 I 2002>2008, Ka 1.6 I 2001>2008, Puma 1.4 16V 1997>2000, Puma 1.6 16V 2000>2002, Puma 1.7 16V 1997>2002, Street Ka 1.6 2003>2005;

MAZDA: 121 iiii 1.25 1996>2003

BOSCH
GE4310 // NEW //

REPLACES / REEMPLAZA:

BOSCH: F 006 B10 310, F 006 B10 370, F 006 K10 082, F 006 K10 100

APPLICATION / APLICACIÓN:

VW: Fox Hatch 2003>2015, Gol G5 2008>, Gol G6 2012>, Saveiro G5 2009>, Saveiro G6 2014, Spacefox/Spacecross 2006>, Voyage 2008>



GM
GE4322 // NEW //

REPLACES / REEMPLAZA:

GM: 52484322; **DELPHI:** 52485309, 52475646;

SIEMENS/VDO: 52415019, 99073009

APPLICATION / APLICACIÓN:

GM: Astra Hatch/Sedan 1999>2011

FIAT
GE4347 // NEW //

REPLACES / REEMPLAZA:

FIAT: 51836347

APPLICATION / APLICACIÓN:

FIAT: Novo Palio, Novo Fiorino, Novo Grand Siena, Novo Uno Way, Vivace 1.0 E 1.4, 10> without air conditioning - 12V

FIAT
GE4362 // NEW //

REPLACES / REEMPLAZA:

FIAT: 51836362

APPLICATION / APLICACIÓN:

FIAT: Argo 2017>, Cronos 2018>, Mobi 2017, Novo Fiorino 2011>

GM
GE4368 // NEW //

REPLACES / REEMPLAZA:

GM: 52402368

APPLICATION / APLICACIÓN:

GM: Meriva - 12 V

BOSCH
GE4403 // NEW //

REPLACES / REEMPLAZA:

BOSCH: F 006 MG0 403, F 006 B10 413, F 006 B10 414, F 006 K10 137, F 006 B10 082

APPLICATION / APLICACIÓN:

VW: Brasilia 1600 1973>1982, CrossFox 1.6 Total Flex 2005>2008, Fox 1.0 2003>2005, Fox 1.0 Total Flex 2005>2009, Fox 1.6 2003>2004, Fox 1.6 Total Flex 2003>2008, Gol III 1.0Mi 1999>2005, Gol III 1.0Mi 16V 1999>2005, Gol III 1.0Mi 16V Turbo 2000>2003, Gol III 1.0Mi Total Flex 2005>2006, Gol III 1.6Mi 1999>2005, Gol III 1.6Mi Total Flex 2003>2005, Gol III 1.8Mi 1999>2003, Gol III 1.8Mi Total Flex 2005>2005, Gol III 2.0Mi 1999>2002, Gol IV 1.0 2005>2008, Gol IV 1.0 Total Flex 2005>2010, Gol IV 1.6 Total Flex 2005>2008, Gol IV 1.8 Total Flex 2005>2008, Parati III 1.0Mi 16V 1999>2003, Parati III 1.0Mi 16V Turbo 2000>2004, Parati III 1.6Mi Total Flex 2003>2005, Parati III 1.8Mi 1999>2005, Parati III 2.0Mi 1999>2005, Parati IV 1.6 Total Flex 2005>, Parati IV 1.8 Total Flex 2005>2008, Saveiro III 1.6Mi 2000>2003, Saveiro III 1.6Mi Total Flex 2003>2005, Saveiro III 1.8Mi 2000>2005, Saveiro IV 1.6 Total Flex 2005>2009, Saveiro IV 1.8 Total Flex 2005>2009

BOSCH
GE4415 // NEW //

REPLACES / REEMPLAZA:

BOSCH: F 006 B10 067, F 006 B10 415

APPLICATION / APLICACIÓN:

FORD: Cargo C1317, MAX TON, C4432E 2002> - with air conditioning - 12V

VALEO
GE4423 // NEW //

REPLACES / REEMPLAZA:

VALEO: END 279H, 970096U; **SIEMENS:** 539 9045 200;

MERCEDES BENZ: A1688301162

APPLICATION / APLICACIÓN:

MERCEDES BENZ: Classe A 160/190 1999>2003

BOSCH
GE4456 // NEW //

REPLACES / REEMPLAZA:

FORD: AS65-18456AA

APPLICATION / APLICACIÓN:

FORD: Fiesta 2005>2014, Ecosport 2005>2012 with air conditioning

GM
GE4662 // NEW //

REPLACES / REEMPLAZA:

GM: 52456662

APPLICATION / APLICACIÓN:

GM: Kadett 1989>1998, Ipanema, Monza - with air conditioning 1982>1996

GM
GE4796 // NEW //

REPLACES / REEMPLAZA:

DENSO: 266796, HRT326; **FIAT:** 51836368

APPLICATION / APLICACIÓN:

FIAT: Grand Siena, Novo Palio, Novo Uno, Nova Fiorino, Mobi

MERCEDES BENZ



GE4801 // NEW //

REPLACES / REEMPLAZA:

MERCEDES BENZ: A1648350007; VALEO: 982602K

APPLICATION / APLICACIÓN:

MERCEDES-BENZ: Gl-Class Gl 320 Cdi / 350 Bluetec 4-Matic 2009>2012, Gl-Class Gl 320 Cdi 4-Matic 2006>2009, Gl-Class Gl 350 Cdi 4-Matic 2009>2012, Gl-Class Gl 350 Cdi 4-Matic 2010>2012, Gl-Class Gl 420 Cdi 4-Matic 2006>2009, Gl-Class Gl 450 4-Matic 2006>2012, Gl-Class Gl 450 Cdi 4-Matic 2009>2012, Gl-Class Gl 500 4-Matic 2006>2012, M-Class Mi 280 Cdi 4-Matic 2005>2009, M-Class Mi 300 Cdi 4-Matic 2009>2011, M-Class Mi 300 Cdi 4-Matic 2010>2011, M-Class Mi 320 Cdi 4-Matic 2005>2009, M-Class Mi 350 4-Matic 2005>2011, M-Class Mi 350 Cdi 4-Matic 2009>2011, M-Class Mi 350 Cdi 4-Matic 2010>2011, M-Class Mi 420 Cdi 4-Matic 2006>2009, M-Class Mi 450 Cdi 4-Matic 2009>2011, M-Class Mi 500 4-Matic 2007>2011, M-Class Mi 500 4-Matic 2005>2011, M-Class Mi 63 Amg 4-Matic 2006>2011

GM



GE4837 // NEW //

REPLACES / REEMPLAZA:

GM: 97463837, 90463837; VALEO: 90463837

APPLICATION / APLICACIÓN:

OPEL: Vectra B 1.6 | 1995>2002, Vectra B 1.6 | 16V 1995>2002, Vectra B 1.7 Td 1995>1998, Vectra B 1.8 | 16V 1995>2000, Vectra B 1.8 | 16V 2000>2002, Vectra B 2.0 Di 16V 1996>2002, Vectra B 2.0 Dti 16V 1997>2002, Vectra B 2.0 | 16V 1995>2000, Vectra B 2.2 Dti 16V 2000>2002, Vectra B 2.5 I V6 1995>2000, Vectra B Hatch 1.6 | 1995>2003, Vectra B Hatch 1.6 | 16V 1995>2002, Vectra B Hatch 1.7 Td 1995>1998, Vectra B Hatch 1.8 | 16V 1995>2000, Vectra B Hatch 1.8 | 16V 2000>2003, Vectra B Hatch 2.0 Di 16V 1996>2000, Vectra B Hatch 2.0 Dti 16V 1997>2003, Vectra B Hatch 2.0 | 16V 1995>2000, Vectra B Hatch 2.5 I V6 1995>2000, Vectra B Sw 1.6 | 16V 1996>2002, Vectra B Sw 1.8 | 16V 1996>2000, Vectra B Sw 1.8 | 16V 2000>2003, Vectra B Sw 2.0 Di 16V 1996>2000, Vectra B Sw 2.0 Dti 16V 1997>2003, Vectra B Sw 2.0 | 16V 1996>2000, Vectra B Sw 2.5 I V6 1996>2000

FORD



GE4846 // NEW //

REPLACES / REEMPLAZA:

FORD: 1C3H 19846 BA, 1C3H-19805-AA

APPLICATION / APLICACIÓN:

FORD: F250, F350, F4000 1998> 12V

VALEO



GE4873 // NEW //

REPLACES / REEMPLAZA:

VALEO: 698842C, 970442T; GM: 93307873, 93395381;

SIEMENS: 987423D; BOSCH: F 006 B10 012

APPLICATION / APLICACIÓN:

GM: Corsa 1.0 2002>2010

VALEO



GE4876 // NEW //

REPLACES / REEMPLAZA:

SCANIA: 1854876; MEAT & DORIA: K92217

APPLICATION / APLICACIÓN:

SCANIA: P,G,R,T - Series G 230 2007>, P,G,R,T - Series G 230, P 230 2007>, P,G,R,T - Series G 230, P 230 2009>, P,G,R,T - Series G 230, P 230 2006>, P,G,R,T - Series G 270, P 270 2004>, P,G,R,T - Series G 270, P 270, R 270 2004>, P,G,R,T - Series G 280 2007>, P,G,R,T - Series G 310 2004>, P,G,R,T - Series G 310, P 310 2004>, P,G,R,T - Series G 310, P 310 2009>, P,G,R,T - Series G 310, P 310 2012>, P,G,R,T - Series G 320 2007>, P,G,R,T - Series G 340, P 340 2004>, P,G,R,T - Series G 340, P 340, R 340 2004>, P,G,R,T - Series G 340, R 340 2006>, P,G,R,T - Series G 360 2007>, P,G,R,T - Series G 360 2012>, P,G,R,T - Series G 360, P 360 2010>, P,G,R,T - Series G 360, P 360, R 360 2010>, P,G,R,T - Series G 370 2012>, P,G,R,T - Series G 380 2005>, P,G,R,T - Series G 380 2004>, P,G,R,T - Series G 380, P 380 2004>, P,G,R,T - Series G 380, P 380, R 380 2004>, P,G,R,T - Series G 380, P 380, R 380 2008>, P,G,R,T - Series G 380, P 380, R 380 2005>, P,G,R,T - Series G 400 2007>, P,G,R,T - Series G 400, P 400, R 400 2010>, P,G,R,T - Series G 400, P 400, R 400 2008>, P,G,R,T - Series G 400, P 400, R 400 2009>, P,G,R,T - Series G 400, R 400 2008>, P,G,R,T - Series G 400, R 400 2010>, P,G,R,T - Series G 400, R 400 2009>, P,G,R,T - Series G 410 2012>, P,G,R,T - Series G 410, P 410 2013>, P,G,R,T - Series G 410, P 410, R 410 2013>, P,G,R,T - Series G 410, R 410 2013>, P,G,R,T - Series G 420 2005>, P,G,R,T - Series G 420 2004>, P,G,R,T - Series G 420, P 420, R 420 2004>, P,G,R,T - Series G 420, P 420, R 420 2005>, P,G,R,T - Series G 420, R 420 2008>, P,G,R,T - Series G 440 2007>, P,G,R,T - Series G 440 2009>, P,G,R,T - Series G 440, R 440 2007>, P,G,R,T - Series G 440, R 440 2008>, P,G,R,T - Series G 440, R 440 2010>, P,G,R,T - Series G 440, R 440 2009>, P,G,R,T - Series G 450 2012>, P,G,R,T - Series G 450, P 450, R 450 2013>, P,G,R,T - Series G 450, R 450 2013>, P,G,R,T - Series G 450, R 450 2012>, P,G,R,T - Series G 470 2005>, P,G,R,T - Series G 470 2007>, P,G,R,T - Series G 470 2010>, P,G,R,T - Series G 470, P 470, R 470 2005>, P,G,R,T - Series G 470, R 470 2004>, P,G,R,T - Series G 480 2007>, P,G,R,T - Series G 480 2005>, P,G,R,T - Series G 480 2012>, P,G,R,T - Series G 480, R 480 2008>, P,G,R,T - Series G 480, R 480 2010>, P,G,R,T - Series G 480, R 480 2006>, P,G,R,T - Series G 480, R 480 2004>, P,G,R,T - Series G 480, R 480 2010>, P,G,R,T - Series G 490 2012>, P,G,R,T - Series G 490, R 490 2013>, P,G,R,T - Series P 230 2008>, P,G,R,T - Series P 230 2009>, P,G,R,T - Series P 230 2007>, P,G,R,T - Series P 230 2004>, P,G,R,T - Series P 230 2012>, P,G,R,T - Series P 230 2005>, P,G,R,T - Series P 230 2006>, P,G,R,T - Series P 230, R 230 2004>, P,G,R,T - Series P 230, R 230 2005>, P,G,R,T - Series P 250 2010>, P,G,R,T - Series P 250 2013>, P,G,R,T - Series P 250 2012>, P,G,R,T - Series P 250 2011>, P,G,R,T - Series P 260 2004>, P,G,R,T - Series P 270 2004>, P,G,R,T - Series P 270 2006>, P,G,R,T - Series P 270 2012>, P,G,R,T - Series P 270, R 270 2006>, P,G,R,T - Series P 270, R 270 2004>, P,G,R,T - Series P 280 2004>, P,G,R,T - Series P 280 2009>, P,G,R,T - Series P 280 2012>, P,G,R,T - Series P 280 2013>, P,G,R,T - Series P 300 2004>, P,G,R,T - Series P 310 2004>, P,G,R,T - Series P 310 2012>, P,G,R,T - Series P 310 2009>, P,G,R,T - Series P 310 2006>, P,G,R,T - Series P 310 2011>, P,G,R,T - Series P 310 2003>, P,G,R,T - Series P 310 2008>, P,G,R,T - Series P 310 2010>, P,G,R,T - Series P 310, R 310 2004>, P,G,R,T - Series P 320 2012>, P,G,R,T - Series P 320 2009>, P,G,R,T - Series P 320 2013>, P,G,R,T - Series P 340 2004>, P,G,R,T - Series P 340 2005>, P,G,R,T - Series P 340 2011>, P,G,R,T - Series P 340 2006>, P,G,R,T - Series P 340 2008>, P,G,R,T - Series P 340, R 340 2004>, P,G,R,T - Series P 340, R 340 2006>, P,G,R,T - Series P 360 2009>, P,G,R,T - Series P 360 2013>, P,G,R,T - Series P 360 2008>, P,G,R,T - Series P 360 2010>, P,G,R,T - Series P 360 2007>, P,G,R,T - Series P 360, R 360 2010>, P,G,R,T - Series P 370 2013>, P,G,R,T - Series P 370 2012>, P,G,R,T - Series P 380 2004>, P,G,R,T - Series P 380 2006>, P,G,R,T - Series P 380 2005>, P,G,R,T - Series P 380, R 380 2004>, P,G,R,T - Series P 380, R 380 2006>, P,G,R,T - Series P 380, R 380 2005>, P,G,R,T - Series P 380, R380 2004>, P,G,R,T - Series P 400 2010>, P,G,R,T - Series P 400 2007>, P,G,R,T - Series P 400 2009>, P,G,R,T - Series P 400, R 400 2010>, P,G,R,T - Series P 410 2013>, P,G,R,T - Series P 410 2011>, P,G,R,T - Series P 420 2004>, P,G,R,T - Series P 420 2005>, P,G,R,T - Series P 420, G 420 2008>, P,G,R,T - Series P 420, R 420 2005>, P,G,R,T - Series P 420, R 420 2004>, P,G,R,T - Series P 420, R 420 2006>, P,G,R,T - Series P 440 2011>, P,G,R,T - Series P 440, R 440 2010>, P,G,R,T - Series P 450 2013>, P,G,R,T - Series P 450 2012>, P,G,R,T - Series P 470, R 470 2004>, P,G,R,T - Series P 480, R 480 2010>, P,G,R,T - Series P 480, R 480 2004>, P,G,R,T - Series P 500, R 500 2009>, P,G,R,T - Series P 500, R 500 2004>, P,G,R,T - Series P 550 2012>, P,G,R,T - Series P 560, R 560 2006>, P,G,R,T - Series P 560, R 560 2004>, P,G,R,T - Series P 580, R 580 2004>, P,G,R,T - Series P 620, R 620 2006>, P,G,R,T - Series R 340 2005>, P,G,R,T - Series R 340 2004>, P,G,R,T - Series R 340 2006>, P,G,R,T - Series R 360 2007>, P,G,R,T - Series R 360 2010>, P,G,R,T - Series R 370 2012>, P,G,R,T - Series R 380 2004>, P,G,R,T - Series R 380 2010>, P,G,R,T - Series R 400 2010>, P,G,R,T - Series R 400 2007>, P,G,R,T - Series R 410 2012>, P,G,R,T - Series R 420 2004>, P,G,R,T - Series R 420 2007>, P,G,R,T - Series R 440 2010>, P,G,R,T - Series R 440 2007>, P,G,R,T - Series R 450 2012>, P,G,R,T - Series R 450 2013>, P,G,R,T - Series R 470 2007>, P,G,R,T - Series R 470 2004>, P,G,R,T - Series R 480 2004>, P,G,R,T - Series R 480 2010>, P,G,R,T - Series R 480 2005>, P,G,R,T - Series R 480 2007>, P,G,R,T - Series R 490 2012>, P,G,R,T - Series R 500 2008>, P,G,R,T - Series R 500 2004>, P,G,R,T - Series R 500 2009>, P,G,R,T - Series R 520 2013>, P,G,R,T - Series R 520 2012>, P,G,R,T - Series R 560 2004>, P,G,R,T - Series R 560 2006>, P,G,R,T - Series R 560 2009>, P,G,R,T - Series R 560 2008>, P,G,R,T - Series R 560, P 560 2009>, P,G,R,T - Series R 580 2004>, P,G,R,T - Series R 580 2013>, P,G,R,T - Series R 580 2014>, P,G,R,T - Series R 580, P 580 2009>, P,G,R,T - Series R 620 2004>, P,G,R,T - Series R 620 2006>, P,G,R,T - Series R 620 2009>, P,G,R,T - Series R 620 2008>, P,G,R,T - Series R 620 2005>, P,G,R,T - Series R 730 2010>, P,G,R,T - Series T 420 2004>, P,G,R,T - Series T 470 2004>2005, P,G,R,T - Series T 470 2004>, P,G,R,T - Series T 500 2004>

VALEO**GE4886 // NEW //**

REPLACES / REEMPLAZA:

VALEO: 700886, 996014W; **VW:** 5U0820021B

APPLICATION / APLICACIÓN:

VW: Gol G5, Novo Voyage, Saveiro G5**GM****GE4981 // NEW //**

REPLACES / REEMPLAZA:

GM: 52477152, 52498981

APPLICATION / APLICACIÓN:

GM: S101996>2004, Blazer 1996>2004 with air conditioning - 12V



EMS COMPONENTS | SISTEMA DE CONTROL DE MOTOR

RESISTENCE | RESISTENCIA

GE3001

FEATURES: FAN RESISTENCE
CARACTERÍSTICAS: RESISTENCIA DEL VENTILADOR
Resistance / Resistencia: T1 - T2: 0,666Ω
REPLACE / REEMPLAZA:
 6S659A819AA, 96FB9A819AC, PPWA-122
APPLICATION / APLICACIONE:
Fiat: Ka 1.0/1.6 1999>2007

GE3002

FEATURES: FAN RESISTENCE
CARACTERÍSTICAS: RESISTENCIA DEL VENTILADOR
Resistance / Resistencia: T1 - T2: 0,307Ω
REPLACE / REEMPLAZA:
 0 67782831, PPWA-067
APPLICATION / APLICACIONE:
Fiat: Palio 1.0/1.2/1.3/1.4/1.5/1.6/1.8 1996>2010

GE3003

FEATURES: FAN RESISTENCE
CARACTERÍSTICAS: RESISTENCIA DEL VENTILADOR
Resistance / Resistencia: T1 - T2: 0,513Ω
REPLACE / REEMPLAZA:
 5U0959493A
APPLICATION / APLICACIONE:
VW: Gol 1.0/1.6 2005>2014

GE3004

FEATURES: FAN RESISTENCE
CARACTERÍSTICAS: RESISTENCIA DEL VENTILADOR
Resistance / Resistencia: T1 - T2: 0,465Ω
REPLACE / REEMPLAZA:
VW: 377959493E, PPWA040
APPLICATION / APLICACIONE:
VW: Gol I 1.8 1984>1997

GE3005

FEATURES: FAN RESISTENCE
CARACTERÍSTICAS: RESISTENCIA DEL VENTILADOR
Resistance / Resistencia: T1 - T2: 0,313Ω
REPLACE / REEMPLAZA:
Fiat: 1334788080, PPWA-105
APPLICATION / APLICACIONE:
Fiat: Ducato 2.5 1986>1990

GE3006

FEATURES: FAN RESISTENCE
CARACTERÍSTICAS: RESISTENCIA DEL VENTILADOR
Resistance / Resistencia: T1 - T2: 0,112Ω
Resistance / Resistencia: T1 - T3: 0,316Ω
Resistance / Resistencia: T1 - T4: 0,679Ω
REPLACE / REEMPLAZA:
GM: 93341907, HRAH-RWI 38/10
APPLICATION / APLICACIONE:
Opel: Corsa C Hatch 1.0 (F08, F68)/1.2 (F08, F68)/1.2 Twinport (F08, F68)/1.4 Twinport (F08, F68)/1.4 (F08, F68)/ 2000>2009

GE3007

FEATURES: FAN RESISTENCE
CARACTERÍSTICAS: RESISTENCIA DEL VENTILADOR
Resistance / Resistencia: T1 - T2: 0,234Ω
REPLACE / REEMPLAZA:
Fiat: 7521262, PPWA-89
APPLICATION / APLICACIONE:
Fiat: Brava Hatch 1.2 16V 80/ 2000>2002

GE3008

FEATURES: FAN RESISTENCE
CARACTERÍSTICAS: RESISTENCIA DEL VENTILADOR
Resistance / Resistencia: T1 - T2: 0,526Ω
Resistance / Resistencia: T1 - T3: 0,084Ω
Resistance / Resistencia: T1 - T4: 2,075Ω
REPLACE / REEMPLAZA:
Fiat: 7078695, PPWA-118
APPLICATION / APLICACIONE:
Fiat: Palio Weekend Estate 1.2 (178DYA1A, 178DXS1A)/1.2/1.6 16V (178DXD1A)/1.6 16V/1.7 TD/1.9 D/1.9 JTD/ 2001>2012, Strada Pickup 1.2/1.3 D Multijet/1.7 TD/ 2003>2006

GE3009

FEATURES: FAN RESISTENCE
CARACTERÍSTICAS: RESISTENCIA DEL VENTILADOR
Resistance / Resistencia: T1 - T2: 0,432Ω
Resistance / Resistencia: T1 - T3: 1,407Ω
Resistance / Resistencia: T1 - T4: 3,453Ω
REPLACE / REEMPLAZA:
VW: 377959493; **Fiat:** PPWA-121
APPLICATION / APLICACIONE:
Fiat: Palio Palio 1.0/1.2/1.3/1.4/1.5/1.6/1.8 1996>2017

GE3010

FEATURES: FAN RESISTENCE
CARACTERÍSTICAS: RESISTENCIA DEL VENTILADOR
Resistance / Resistencia: T1 - T2: 0,225Ω
REPLACE / REEMPLAZA:
GM: 93337584
APPLICATION / APLICACIONE:
GM: Celta 1.0/1.4 1999>2006

GE3011



FEATURES: FAN RESISTENCE
 CARACTERÍSTICAS: RESISTENCIA DEL VENTILADOR
Resistance / Resistencia: T1 - T2: 0,749Ω
REPLACE / REEMPLAZA:
VW: 325.959.493-1, PPWA-036
APPLICATION / APLICACIONE:
VW: Santana 1.8 1984>1989

GE3012



FEATURES: FAN RESISTENCE
 CARACTERÍSTICAS: RESISTENCIA DEL VENTILADOR
Resistance / Resistencia: T1 - T2: 0,401Ω
REPLACE / REEMPLAZA:
VW: 325.959.493-2, PPWA-041
APPLICATION / APLICACIONE:
VW: Santana 1.8/2.0 1998>2006

GE3013



FEATURES: FAN RESISTENCE
 CARACTERÍSTICAS: RESISTENCIA DEL VENTILADOR
Resistance / Resistencia: T1 - T2: 0,415Ω
REPLACE / REEMPLAZA:
Ford: 4M359A819AA, EZT31018
APPLICATION / APLICACIONE:
Ford: Courier 1.6 1999>2013

GE3014



FEATURES: EVAPORATIVE BOX RESISTENCE
 CARACTERÍSTICAS: RESISTENCIA DE LA CAJA EVAPORATIVA
Resistance / Resistencia: T1 - T2: 1,287Ω
Resistance / Resistencia: T1 - T3: 1,999Ω
Resistance / Resistencia: T1 - T4: 2,406Ω
Resistance / Resistencia: T1 - T5: 2,414Ω
REPLACE / REEMPLAZA:
Citroën/ Peugeot: FR1420051
APPLICATION / APLICACIONE:
Citroën: Picasso 1.6/2.0 2000>2012

GE3015



FEATURES: EVAPORATIVE BOX RESISTENCE
 CARACTERÍSTICAS: RESISTENCIA DE LA CAJA EVAPORATIVA
Resistance / Resistencia: T1 - T2: 2,654Ω
Resistance / Resistencia: T1 - T3: 0,872Ω
Resistance / Resistencia: T1 - T4: 0,361Ω
REPLACE / REEMPLAZA:
GM: 90535076; **Meat & Doria:** K109067
APPLICATION / APLICACIONE:
GM: Corsa 1.0 Vhc - 2002>2012

GE3016



FEATURES: FAN RESISTENCE
 CARACTERÍSTICAS: RESISTENCIA DEL VENTILADOR
Resistance / Resistencia: T1 - T2: 0,301Ω
REPLACE / REEMPLAZA:
Fiat: 50003504, PPWA-068
APPLICATION / APLICACIONE:
Fiat: Tempra 2.0 1992>1998

GE3017



FEATURES: FAN RESISTENCE
 CARACTERÍSTICAS: RESISTENCIA DEL VENTILADOR
Resistance / Resistencia: T1 - T2: 0,380Ω
Resistance / Resistencia: T1 - T3: 0,748Ω
Resistance / Resistencia: T1 - T4: 1,922Ω
REPLACE / REEMPLAZA:
VW: 377959493A, PPWA-122
APPLICATION / APLICACIONE:
VW: Fox 2003>

GE3018



FEATURES: FAN RESISTENCE
 CARACTERÍSTICAS: RESISTENCIA DEL VENTILADOR
Resistance / Resistencia: T1 - T2: 0,484Ω
Resistance / Resistencia: T1 - T3: 1,328Ω
Resistance / Resistencia: T1 - T4: 3,445Ω
Resistance / Resistencia: T2 - T3: 0,959Ω
Resistance / Resistencia: T2 - T4: 2,983Ω
Resistance / Resistencia: T3 - T4: 3,046Ω
REPLACE / REEMPLAZA:
VW: PPWA-038, ZBC905.051-A
APPLICATION / APLICACIONE:
VW: Gol 1.6/1.8/2.0 1992>1996

GE3019



FEATURES: EVAPORATIVE BOX RESISTENCE
 CARACTERÍSTICAS: RESISTENCIA DE LA CAJA EVAPORATIVA
Resistance / Resistencia: T1 - T2: 0,372Ω
Resistance / Resistencia: T1 - T3: 2,645Ω
Resistance / Resistencia: T1 - T4: 0,957Ω
REPLACE / REEMPLAZA:
Ford: E9UH19A706-AA
APPLICATION / APLICACIONE:
Ford: F250 4.2/3.9 1998>2003

GE3020



FEATURES: EVAPORATIVE BOX RESISTENCE
 CARACTERÍSTICAS: RESISTENCIA DE LA CAJA EVAPORATIVA
Resistance / Resistencia: T1 - T2: 0,818Ω
Resistance / Resistencia: T1 - T3: 2,246Ω
Resistance / Resistencia: T1 - T4: 0,293Ω
REPLACE / REEMPLAZA:
Audi/ VW: 6Q0959263A, S8810001
APPLICATION / APLICACIONE:
Audi: A1 1.2 TFSI/1.4 TFSI/2.0 TFSI quattro/1.6 TDI/2.0 TDI/ 2010>2015, A1 Sportback: 1.2 TFSI/1.4 TFSI/1.6 TDI/2.0 TDI/ 2011>2015, A2 Hatch: 1.4/1.6 FSI/1.2 TDI/1.4 TDI/ 2000>2005

GE3021

FEATURES: FAN RESISTANCE
CARACTERÍSTICAS: RESISTENCIA DEL VENTILADOR
Resistance / Resistencia: T1 - T2: 0,630Ω
Resistance / Resistencia: T1 - T3: 3,164Ω
REPLACE / REEMPLAZA:
Fiat: 7078745, PPWA-119

APPLICATION / APLICACIONE:
Fiat: Palio Weekend Estate 1.2 (178DYA1A, 178DXS1A)/1.2/1.6 16V (178DXD1A)/1.6 16V/1.7 TD/1.9 D/1.9 JTD/ 2001>2012

GE3022

FEATURES: EVAPORATIVE BOX RESISTANCE
CARACTERÍSTICAS: RESISTENCIA DE LA CAJA EVAPORATIVA
Resistance / Resistencia: T1 - T2: 1,847Ω
Resistance / Resistencia: T1 - T3: 1,420Ω
Resistance / Resistencia: T1 - T4: 1,122Ω
REPLACE / REEMPLAZA:
Ford: EZT 31060

APPLICATION / APLICACIONE:
Ford: Fiesta 1.0/1.6 2002>2010

GE3023

FEATURES: FAN RESISTANCE
CARACTERÍSTICAS: RESISTENCIA DEL VENTILADOR
Resistance / Resistencia: T1 - T2: 0,983Ω
Resistance / Resistencia: T1 - T3: 2,404Ω
REPLACE / REEMPLAZA:
VW: PPWA-37, ZBC905.051

APPLICATION / APLICACIONE:
VW: Gol 1.6/1.8/2.0 1984>1997

GE3024

FEATURES: FAN RESISTANCE
CARACTERÍSTICAS: RESISTENCIA DEL VENTILADOR
Resistance / Resistencia: T1 - T2: 0,219Ω
REPLACE / REEMPLAZA:
GM: M51001400

APPLICATION / APLICACIONE:
GM: Spin 1.8 2012>2017

GE3025

FEATURES: EVAPORATIVE BOX RESISTANCE
CARACTERÍSTICAS: RESISTENCIA DE LA CAJA EVAPORATIVA
Resistance / Resistencia: T1 - T2: 0,706Ω
Resistance / Resistencia: T1 - T3: 1,122Ω
Resistance / Resistencia: T1 - T4: 0,442Ω
REPLACE / REEMPLAZA:
Ford: 1311115, 3M5H-18B647-BA, SX4H18B647AA

APPLICATION / APLICACIONE:
Ford: Cougar Coupe 2.0 16V/2.5 V6 24V/2.5 ST 200/ 2000>201, Focus Mk 1 Hatch 1.4 16V/1.6 16V/1.8 DI / TDDi/1.8 Turbo DI / TDDi/1.8 TDCi/1.8 16V/2.0 16V/ST170/RS/ 2001>2004, Focus Mk 1 Saloon 1.4 16V/1.6 16V/1.8 16V/1.8 Turbo DI / TDDi/1.8 TDCi/2.0 16V/ 2001>2005, Focus Mk 1 Estate 1.4 16V/1.6 16V/1.8 16V/2.0 16V/ST170/1.8 DI / TDDi/1.8 Turbo DI / TDDi/1.8 TDCi/ 2001>2004, Mondeo Mk 1 Hatch 1.6 i 16V/1.8 i 16V/1.8 i 16V 4x4/2.0 i 16V 4x4/2.0 i 16V/2.5 i 24V/1.8 TD/ 1993>1996, Mondeo Mk 1 Saloon 1.6 i 16V/1.8 i 16V/2.0 i 16V 4x4/2.0 i 16V/2.5 i 24V/1.8 TD/ 1993>1996, Mondeo Mk 1 Estate 1.6 i 16V/1.8 i 16V/1.8 i 16V 4x4/2.0 i 16V 4x4/2.0 i 16V/2.5 i 24V/1.8 TD/ 1993>1996, Mondeo Mk 2 Hatch 1.6 i/1.6 i 16V/1.8 i/2.0 i/2.5 24V/2.5 ST 200/1.8 TD/ 2000>200, Mondeo Mk 2 Saloon 1.6 i/1.6 i 16V/1.8 i/2.0 i/2.5 24V/2.5 ST 200/1.8 TD/ 2000>200, Mondeo Mk 2 Estate 1.6 i/1.6 i 16V/1.8 i/2.0 i/2.5 24V/2.5 ST 200/1.8 TD/ 1996>200, Mondeo Mk 3 Hatch: 1.8 16V/1.8 SCI/2.0 16V/2.5 V6 24V/3.0 V6 24V/ST220/2.0 16V DI / TDDi / TDCi/2.0 16V TDDi / TDCi/2.0 TDCi/2.2 TDCi/ 2000>2007, Mondeo Mk 3 Saloon 1.8 16V/1.8 SCI/2.0 16V/2.5 V6 24V/3.0 V6 24V/ST220/2.0 16V DI / TDDi / TDCi/2.0 16V TDDi / TDCi/2.0 TDCi/2.2 TDCi/2.0 TDCi/2.2 TDCi/ 2000>2007, Mondeo Mk 3 Estate 1.8 16V/1.8 SCI/2.0 16V/2.5 V6 24V/3.0 V6 24V/ST220/2.0 16V DI / TDDi / TDCi/2.0 16V TDDi / TDCi/2.0 TDCi/2.2 TDCi/2.0 TDCi/2.2 TDCi/ 2000>2007, Tourneo Connect Mpv 1.8 16V/1.8 TDCi /TDDi /DI/1.8 TDCi/ 2002>2013

GE3026

FEATURES: FAN RESISTANCE
CARACTERÍSTICAS: RESISTENCIA DEL VENTILADOR
Resistance / Resistencia: T1 - T2: 7,678Ω
Resistance / Resistencia: T1 - T3: 8,102Ω
Resistance / Resistencia: T1 - T4: 9,162Ω
REPLACE / REEMPLAZA:

1845791

APPLICATION / APLICACIONE:
Opel: Astra F Hatch 1.4 i (F08, M08, F68, M68)/1.4 Si (F08, M08, F68, M68)/1.4 i 16V (F08, M08, F68, M68)/1.6 i (F08, M08, F68, M68)/1.6 Si (F08, M08, F68, M68)/1.6 i 16V (F08, M08, F68, M68)/1.8 i (F08, M08, F68, M68)/1.8 i 16V (F08, M08, F68, M68)/2.0 i (F08, M08, F68, M68)/2.0 i 16V (F08, M08, F68, M68)/2.0 GSI 16V (F08, M08, F68, M68)/1.7 D (F08, M08, F68, M68)/1.7 TD (F08, M08, F68, M68)/1.7 TDS (F08, M08, F68, M68)/ 1991>1998, Astra F Saloon 1.4 i (F19, M19)/1.4 Si (F19, M19)/1.4 i 16V (F19, M19)/1.6 i (F19, M19)/1.6 Si (F19, M19)/1.6 i 16V (F19, M19)/1.8 i (F19, M19)/1.8 i 16V (F19, M19)/2.0 i (F19, M19)/2.0 i 16V (F19, M19)/1.7 D (F19, M19)/1.7 TD (F19, M19)/1.7 TDS (F19, M19)/ 1991>1998, Astra F Estate 1.4 i (F35, M35)/1.4 Si (F35, M35)/1.4 i 16V (F35, M35)/1.6 i (F35, M35)/1.6 Si (F35, M35)/1.6 i 16V (F35, M35)/1.8 i (F35, M35)/1.8 i 16V (F35, M35)/2.0 i (F35, M35)/2.0 i 16V (F35, M35)/1.7 D (F35, M35)/1.7 TD (F35, M35)/1.7 TDS (F35, M35)/ 1991>1998, Astra F Convertible 1.4 Si/1.4 i 16V/1.6 i/1.8 i 16V/2.0 i/ 1993>1996, Calibra A 2.0 i (M07)/2.0 i 4x4 (M07)/2.0 i 16V (M07)/2.0 i 16V 4x4 (M07)/2.0 i Turbo 4x4 (M07)/2.5 i V6 (M07)/ 1989>1997, Vectra A Hatch 1.6 i (F68, M68)/1.6 i Cat (F68, M68)/1.6 S/1.8 S (F68, M68)/1.8 i (F68, M68)/1.8 i Cat (F68, M68)/2.0 (F68, M68)/2.0 i (F68, M68)/2.0 i Cat (F68, M68)/2.0 i GT (F68, M68)/2.0 i 16V (F68, M68)/2.0 i 16V Cat (F68, M68)/2.5 V6 (F68, M68)/1.7 D (F68, M68)/1.7 TD (F68, M68)/ 1988>1995, Vectra A Saloon 1.6 (F19, M19)/1.6 i (F19, M19)/1.8 S (F19, M19)/1.8 S 4x4 (F19, M19)/1.8 i Cat (F19, M19)/2.0 (F19, M19)/2.0 i (F19, M19)/2.0 i Cat (F19, M19)/2.0 i 4x4 (F19, M19)/2.0 i Cat 4x4 (F19, M19)/2.0 i 16V (F19, M19)/2.0 i 16V 4x4 (F19, M19)/2000/GT 16V (F19, M19)/2000/GT 16V Cat (F19, M19)/2000 16V 4x4 (F19, M19)/2000/GT 16V Cat 4x4 (F19, M19)/2.0 i Turbo 4x4 (F19, M19)/2.5 V6 (F19, M19)/1.7 D (F19, M19)/1.7 TD (F19, M19)/ 1988>1995;

Saab: 9-3 Hatch 2.0 i/2.0 Turbo/2.0 SE Turbo/2.3 i/2.3 Turbo/2.2 TID/ 2000>2002, 9-3 Cabrio 2.0 i/2.0 Turbo/2.0 SE Turbo/2.3 i/2.3 Turbo/ 2001>2003, 900 Mk 2 Hatch 2.0 i/2.0 -16 Turbo/2.3 -16/2.5 -24 V6/ 1993>1998, 900 Mk 2 Coupe 2.0 i/2.0 -16 Turbo/2.3 -16/2.5 -24 V6/ 1993>1998, 900 Mk 2 Cabrio 2.0 i/2.0 -16 Turbo/2.3 -16/ 1993>1998

GE3027



FEATURES: FAN RESISTANCE
CARACTERÍSTICAS: RESISTENCIA DEL VENTILADOR
Resistance / Resistencia: T1 - T2: 2,311Ω
Resistance / Resistencia: T1 - T3: 3,264Ω
Resistance / Resistencia: T1 - T4: 4,345Ω
REPLACE / REEMPLAZA:
VW: EP4705, PPWA-112
APPLICATION / APLICACIONE:
VW: Santana 1.8 1984>1989

GE3028



FEATURES: FAN RESISTANCE
CARACTERÍSTICAS: RESISTENCIA DEL VENTILADOR
Resistance / Resistencia: T1 - T2: 5,200Ω
Resistance / Resistencia: T1 - T3: 1,782Ω
REPLACE / REEMPLAZA:
 PPWA-088
APPLICATION / APLICACIONE:
GM: Monza 1.6/1.8/2.0 1984>1996

GE3029



FEATURES: FAN RESISTANCE
CARACTERÍSTICAS: RESISTENCIA DEL VENTILADOR
Resistance / Resistencia: T1 - T2: 0,417Ω
Resistance / Resistencia: T1 - T3: 1,093Ω
REPLACE / REEMPLAZA:
Fiat: 7078760, PPWA-120
APPLICATION / APLICACIONE:
Fiat: Palio 1.0/1.2/1.3/1.6/1.8 1998>2010

GE3030



FEATURES: FAN RESISTANCE
CARACTERÍSTICAS: RESISTENCIA DEL VENTILADOR
Resistance / Resistencia: T1 - T2: 1,040Ω
Resistance / Resistencia: T1 - T3: 4,014Ω
REPLACE / REEMPLAZA:
VW: 377959493-B, PPWA-123
APPLICATION / APLICACIONE:
VW: Gol 1.0/1.6/1.8/2.0 1999>2005

GE3031



FEATURES: EVAPORATIVE BOX RESISTANCE
CARACTERÍSTICAS: RESISTENCIA DE LA CAJA EVAPORATIVA
Resistance / Resistencia: T1 - T2: 1,251Ω
Resistance / Resistencia: T1 - T3: 1,127Ω
Resistance / Resistencia: T1 - T4: 0,824Ω
REPLACE / REEMPLAZA:
Ford/ VW: 3M5H-18B, 647 - AC
APPLICATION / APLICACIONE:
Ford: Focus 1.6/1.8/2.0 2003>2007

GE3032



FEATURES: FAN RESISTANCE
CARACTERÍSTICAS: RESISTENCIA DEL VENTILADOR
Resistance / Resistencia: T1 - T2: 1,815Ω
Resistance / Resistencia: T1 - T3: 0,354Ω
Resistance / Resistencia: T1 - T4: 0,355Ω
Resistance / Resistencia: T1 - T5: 0,349Ω
Resistance / Resistencia: T1 - T6: 0,487Ω
Resistance / Resistencia: T1 - T7: 0,353Ω
Resistance / Resistencia: T1 - T8: 0,351Ω
REPLACE / REEMPLAZA:
Renault: 4415550, 7701057557, 931181462
APPLICATION / APLICACIONE:
Nissan: Interstar Minibus dCi 80/dCi 90/dCi 100/dCi 120/dCi 140/dCi 150/ 2002>2006, Interstar Van dCi 90/dCi 100/dCi 120/dCi 150/dCi 140/ 2002>, Interstar Flatbed dCi 100/dCi 120/dCi 150/dCi 140/ 2003>;
Opel: Movano Minibus 1.9 DTI (JD)/2.2 DTI (JD)/2.5 DTI (JD)/2.5 CDTI (JD)/2.5 D (JD)/2.8 DTI (JD)/3.0 DTI (JD)/ 2000>2001, Movano Van 1.9 DTI (FD)/2.2 DTI (FD)/2.5 DTI (FD)/2.5 CDTI (FD)/2.5 D (FD)/2.8 DTI (FD)/3.0 DTI (FD)/ 2000>201, Movano Flatbed 2.2 DTI (ED, HD, UD0, UD4)/2.5 DTI (ED, HD, UD0, UD4)/2.5 CDTI (ED, HD, UD0, UD4)/2.5 D (ED, HD, UD0, UD4)/2.8 DTI (ED, HD, UD0, UD4)/3.0 DTI (ED, HD, UD0, UD4)/ 2000>2001;
Renault: Master Mk 2 Minibus 1.9 dTi/1.9 dCi 80/2.2 dCi 90/2.5 dCi 120/2.5 dCi/3.0 dCi 140 (JD0T)/ 2000>, Master Mk 2 Van 1.9 dTi/1.9 dCi 80/2.2 dCi 90/2.5 dCi 100 (FD0U, FD0V)/2.5 dCi/2.5 dCi 120/3.0 dCi 140 (HD0S, FD0S, HD1S)/ 2000>, Master Mk 2 Flatbed 2.2 dCi 90/2.5 dCi 100 (ED4V, ED8V)/2.5 dCi 120/2.5 dCi/3.0 dCi 140 (ED0S, UD0S)/ 2000>

GE3033



FEATURES: EVAPORATIVE BOX RESISTANCE
CARACTERÍSTICAS: RESISTENCIA DE LA CAJA EVAPORATIVA
DIGITAL AIR | AIRE DIGITAL
3-WAY CONNECTOR | CONECTOR 3 VÍAS
REPLACE / REEMPLAZA:
Audi/ VW: 1J0907521, 5DS006467-01, 657364M
APPLICATION / APLICACIONE:
Audi: A4 1.8/2.4/2.8 1994>2000

GE3034



FEATURES: EVAPORATIVE BOX RESISTANCE
CARACTERÍSTICAS: RESISTENCIA DE LA CAJA EVAPORATIVA
Resistance / Resistencia: T1 - T2: 1,215Ω
Resistance / Resistencia: T1 - T3: 3,233Ω
Resistance / Resistencia: T1 - T4: 0,268Ω
REPLACE / REEMPLAZA:
VW: 701959263A, 7M01959263G, 7M01959263E, 95NW-18B647-BD
APPLICATION / APLICACIONE:
VW: Golf 1.6/1.8/2.0 1996>1998

EMS

RESISTENCE | RESISTENCIA

GE3035

FEATURES: EVAPORATIVE BOX RESISTENCE

CARACTERÍSTICAS: RESISTENCIA DE LA CAJA EVAPORATIVA

Resistance / Resistencia: T1 - T2: 0,902Ω

Resistance / Resistencia: T1 - T3: 2,309Ω

Resistance / Resistencia: T1 - T4: 0,233Ω

REPLACE / REEMPLAZA:
VW: 7E0959263C, 7L0907521B

APPLICATION / APLICACIONE:
VW: Amarok 2.0 TSI/2.0 BiTDI 4motion/ 2010>2016, Touareg 3.2 V6/4.2 V8/4.2 V8 FSI/6.0 W12/2.5 R5 TDI/3.0 V6 TDI/5.0 V10 TDI/5.0 R50 TDI/ 2002>2010, Transporter T5 Minibus 2.0/3.2 V6/3.2 V6 4motion/1.9 TDI/2.0 TDI/2.0 TDI 4motion/2.5 TDI/2.5 TDI 4motion/ 2003>2015

GE3036

FEATURES: EVAPORATIVE BOX RESISTENCE

CARACTERÍSTICAS: RESISTENCIA DE LA CAJA EVAPORATIVA

Resistance / Resistencia: T1 - T2: 2,427Ω

Resistance / Resistencia: T1 - T3: 3,965Ω

REPLACE / REEMPLAZA:
VW: 2R2959263

APPLICATION / APLICACIONE:
VW: Truck Constellation 24V 24250 24280 31320

GE3037

FEATURES: EVAPORATIVE BOX RESISTENCE

CARACTERÍSTICAS: RESISTENCIA DE LA CAJA EVAPORATIVA

9 WAY CONNECTOR | CONECTOR 9 VÍAS
REPLACE / REEMPLAZA:
Renault: 09732914D, 73412602, 7701040562, FW26625AT

APPLICATION / APLICACIONE:
Renault: Megane Mk 1 Hatch 1.4 Eco (BA0T)/1.4 e (BA0E, BA0V)/1.6 i (BA0L)/1.6 e (BA0F, BA0S)/2.0 i (BA0G)/2.0 16V (BA0H)/1.9 D Eco (BA0A, BA0U, BA0R)/1.9 dT (B/SA0K, B/SA0Y)/1.9 TDI/1.9 dTi (BA08, BA0N)/ 1996>1999, Megane Mk 1 Coupe 1.6 e (DA0F)/2.0 i (DA0G)/2.0 16V (DA0H)/1.9 dTi (DA0N)/ 1996>1999, Megane Convertible 1.6 e (EA0F)/2.0 (EA0G)/2.0 16V (EA0H)/ 1996>1999, Scenic Mk 1 Mpv 1.4 i (JA0E)/1.6 i (JA0L)/1.6 e (JA0F)/2.0 i (JA0G)/1.9 D (JA0J)/1.9 dT (JA0K, JA0Y)/1.9 dTi (JA0N)/ 1996>1999

GE3038

FEATURES: EVAPORATIVE BOX RESISTENCE

CARACTERÍSTICAS: RESISTENCIA DE LA CAJA EVAPORATIVA

2 4/2-WAY CONNECTOR | 2 CONECTOR DE 4/2 VÍAS
REPLACE / REEMPLAZA:
Citroën/ Peugeot: 1308CX, 9662240180

APPLICATION / APLICACIONE:
Citroën: Berlingo Multispace Mpv Mk 2: 1.6 HDi 90/ 2010>, C4 Hatch 1.4 16V/1.6 16V/2.0 16V/1.6 HDi/2.0 HDi/ 2004>2011, C4 ii 1.4 VTi 95/1.6 VTi 120/1.6 VTi 120 LPG/1.6 THP 155/1.6 HDi 90/1.6 HDi 110/2.0 HDi / BlueHDi 150/ 2009>2016, C4 Picasso Mpv 1.6 THP 155/1.8 i 16V/2.0 i 16V/1.6 HDi/1.6 HDi 110/2.0 HDi 138/2.0 HDi 165/ 2006>2013, Ds4 1.6 VTi 120/1.6 THP 155/1.6 THP 200/1.6 HDi 110/2.0 HDi 165/ 2011>2015, Ds5 1.6 THP 155/1.6 THP 200/1.6 HDi 110/2.0 HDi 165/2.0 HDi 165 Hybrid4 4x4/ 2011>2015, Dispatch Mk 2 Mpv 2.0 HDi 95/2.0 HDi 125/ 2011>;

Peugeot: 307 Hatch 1.4/1.4 16V/1.6 16V/2.0 16V/1.4 HDi/1.6 HDi/ 1.6 HDi 110/2.0 HDi 90/2.0 HDi 110/2.0 HDi 135/ 2000>2009, 307 Estate: 1.4/ 2002>2003, 307 Sw Estate 1.4/ 2002>2003, 307 Cc Convertible 1.6 16V/2.0 16V/2.0 HDi 135/ 2003>2009, 308 Sw Estate 1.6 HDi/ 2009>2014, 5008 1.6 HDi/2.0 HDi 136 / BlueHDi 136/ 2010>2017

GE3039

FEATURES: EVAPORATIVE BOX RESISTENCE

CARACTERÍSTICAS: RESISTENCIA DE LA CAJA EVAPORATIVA

Resistance / Resistencia: T1 - T2: 0,060Ω

Resistance / Resistencia: T1 - T3: 0,602Ω

REPLACE / REEMPLAZA:
Citroën: 1267A9, 9641212580

APPLICATION / APLICACIONE:
Citroën: Berlingo Multispace Mpv Mk 1 1.1 i (MFHDZ, MFHFV)/1.4 bivalent/1.4 i (MFKFX, MFKFW, GJKFWB, GJKFWC, GFKFWC)/1.4 i bivalent (MFKFW)/1.6 16V (MFNFU)/1.8 i (MFLFX)/1.8 i 4WD (MFLFX)/1.8 D (MFA9A)/1.9 D (MFWJZ)/1.9 D 4WD (MFWJZ)/1.9 D (MFDJY)/2.0 HDi 90 (MFRHY)/ 2000>2011, C5 Mk 1 Hatch 1.8 16V (DC6FZB, DC6FZE)/2.0 16V (DCRFNC, DCRFNF)/2.0 16V HPI (DCRLZB)/3.0 V6 (DCXFVC, DCXFVF)/2.0 HDi (DCRHYB)/2.0 HDi (DCRHZB, DCRHZE)/2.0 HDi (DC4HXB, DC4HXE)/ 2001>2004, C5 Mk 1 Estate 1.8 16V (DE6FZB, DE6FZE)/2.0 16V (DERFNF, DERFNC, RE-RFNC)/2.0 16V HPI (DERLZB)/3.0 V6 (DEXFVC, DEXFVF)/3.0 Carlsson/2.0 HDi (DERHYB)/2.0 HDi (DERHSB, DERHSE)/2.0 HDi (DE-4HXB, DE4HXE)/ 2001>2004, C8 Mpv 2.0/2.2/3.0 V6/2.0 HDi/2.2 HDi/ 2002>, Xsara Hatch 1.4 i/1.6 16V/2.0 16V/1.4 HDi/1.9 TD/2.0 HDi 90/2.0 HDi 109/ 2000>2005, Xsara Estate 1.4 i/1.6 16V/2.0 16V/1.4 HDi/1.9 D/2.0 HDi 90/2.0 HDi 109/ 2000>2005, Xsara Coupe 1.4 i/1.6 16V/2.0 16V/2.0 i 16V/1.4 HDi/1.9 D/2.0 HDi 90/2.0 HDi 109/ 2000>2005, Xsara Picasso Mpv 1.6/1.8 16V/2.0 16V/1.6 HDi/2.0 HDi/ 2000>2012;

Fiat: Ulysse Mk 2 2.0 (179BXA11, 179BXA1A)/3.0/2.0 JTD/2.0 D Multijet/2.2 JTD/ 2002>2011;

Lancia: Phedra 2.0 (179AXA11, 179AXA1A)/3.0 V6/2.0 JTD/2.0 JTD (179AXB1A)/2.0 D Multijet/2.2 JTD (179AXC1A)/2.2 JTD/ 2002>2010

Peugeot: 406 Saloon 1.6/1.8 16V/2.0 16V/2.0 16V HPI/2.0 Turbo/2.2/3.0 24V/3.0 V6/1.9 TD/2.0 HDi 90/2.0 HDi 110/2.1 TD 12V/2.2 HDi/ 2000>2004, 406 Estate 1.8 16V/2.0 16V/2.0 16V HPI/2.2/2.0 HDi 90/2.0 HDi 110/ 2000>2004, 607 Saloon 2.0/2.2 16V/3.0 V6 24V/2.0 HDi/2.2 HDi/ 2000>2006, 807 Mpv 2.0/2.0 16V/2.2/3.0 V6/2.0 HDi/ 2002>, Partner Mk 1 Mpv 1.1/1.4/1.6 16V/1.6 HDi 75/1.6 HDi 90/1.9 D/2.0 HDi/ 2000>2015

GE3040

FEATURES: EVAPORATIVE BOX RESISTENCE

CARACTERÍSTICAS: RESISTENCIA DE LA CAJA EVAPORATIVA

6-WAY CONNECTOR | CONECTOR DE 6 VÍAS
REPLACE / REEMPLAZA:
Citroën: 644178

APPLICATION / APLICACIONE:
Citroën: Ciberlingo 1.6/1.8 2002>2007

GE3041



FEATURES: EVAPORATIVE BOX RESISTENCE

CARACTERÍSTICAS: RESISTENCIA DE LA CAJA EVAPORATIVA

3-WAY CONNECTOR | CONECTOR 3 VÍAS

REPLACE / REEMPLAZA:

Mercedes-Benz: 210 821 1551, 5HL 351321-131

APPLICATION / APLICACIONE:

MB: E-Class Saloon E 200 (210.035)/E 200 Kompressor (210.048)/E 200 Kompressor (210.045)/E 230 (210.037)/E 240 (210.061)/E 40 (210.062)/E 280 (210.053)/E 280 (210.063)/E 280 4-matic (210.081)/E 320 (210.055)/E 320 (210.065)/E 320 4-matic (210.082)/E 420 (210.072)/ E 430 (210.070)/E 430 4-matic (210.083)/E 50 AMG (210.072)/ E 55 AMG (210.074)/E 200 D (210.003)/E 200 CDI (210.007)/ E 220 D (210.004)/E 220 CDI (210.006)/E 250 D (210.010)/E 250 Turbo-D (210.015)/E 270 CDI (210.016)/E 290 Turbo-D (210.017)/E 300 D (210.020) 2000>1999, E-Class Estate E 200 T (210.235)/E 200 T Kompressor (210.248)/E 200 T Kompressor (210.245)/E 230 T (210.237)/E 240 T (210.261)/E 240 T (210.262)/E 280 T (210.263)/E 280 T 4-matic (210.281)/E 320 T (210.265)/E 320 T 4-matic (210.282)/E 420 T (210.272)/E 430 T (210.270)/E 430 T 4-matic (210.283)/E 55 T AMG (210.274)/E 220 T CDI (210.206)/E 250 T D (210.210)/E 250 T Turbo-D (210.215)/E 270 T CDI (210.216)/E 290 T Turbo-D (210.217)/E 300 T Turbo-D (210.225)/E 320 T CDI (210.226)/ 2000>1999

GE3042



FEATURES: EVAPORATIVE BOX RESISTENCE

CARACTERÍSTICAS: RESISTENCIA DE LA CAJA EVAPORATIVA

5-WAY CONNECTOR | CONECTOR DE 5 VÍAS

REPLACE / REEMPLAZA:

Ford: 8E5Z19E624A

APPLICATION / APLICACIONE:

Ford: Fusion 2.3/ 2.5/ 3.0 2006>2012

GE3043



FEATURES: EVAPORATIVE BOX RESISTENCE

CARACTERÍSTICAS: RESISTENCIA DE LA CAJA EVAPORATIVA

5-WAY CONNECTOR | CONECTOR DE 5 VÍAS

REPLACE / REEMPLAZA:

Bosch: F 011 500 070;

Citroën/ Peugeot: 135 017 03, 135 032 01

APPLICATION / APLICACIONE:

GM: Cruze 1.6/ 2009>;

Opel: Astra J 1.4 (68)/1.4 Turbo (68)/1.4 LPG (68)/1.6 (68)/1.6 SIDI (68)/1.6 Turbo (68)/1.3 CDTi (68)/1.6 CDTi (68)/1.7 CDTi (68)/2.0 CDTi (68)/2.0 BiTurbo CDTi (68)/ 2009>2015, Astra J Saloon 1.4 (69)/1.4 Turbo (69)/1.4 LPG (69)/1.6 (69)/1.6 SIDI (69)/1.6 Turbo (69)/1.3 CDTi (69)/1.6 CDTi (69)/1.7 CDTi (69)/ 2012>2016, Astra J Gtc 1.4 (08)/1.6 SIDI (08)/1.6 (08)/1.8 (08)/2.0 (08)/1.6 CDTi (08)/1.7 CDTi (08)/2.0 CDTi (08)/2.0 BiTurbo CDTi (08)/ 2011>2015, Astra J Sports Tourer 1.4 Turbo (35)/1.4 LPG (35)/1.6 (35)/1.6 SIDI (35)/1.6 Turbo (35)/1.3 CDTi (35)/1.6 CDTi (35)/1.7 CDTi (35)/2.0 CDTi (35)/2.0 BiTurbo CDTi (35)/ 2010>2015, Cascada 1.4 (67)/1.4 Turbo (67)/1.6 SIDI (67)/1.6 (67)/2.0 CDTi (67)/ 2013>2019, Insignia Hatch 1.4 (68)/1.4 LPG (68)/1.6 (68)/1.6 SIDI (68)/1.6 Turbo (68)/1.8 (68)/2.0 Turbo (68)/2.0 E85 Turbo (68)/2.0 Turbo 4x4 (68)/2.8 V6 Turbo 4x4 (68)/2.8 V6 Turbo OPC 4x4 (68)/1.6 CDTi (68)/2.0 CDTi (68)/2.0 CDTi 4x4 (68)/2.0 Biturbo CDTi (68)/2.0 Biturbo CDTi 4x4 (68)/ 2008>2017, Insignia Saloon 1.4 (69)/1.4 LPG (69)/1.6 (69)/1.6 SIDI (69)/1.6 Turbo (69)/1.8 (69)/2.0 Turbo (69)/2.0 Turbo E85 (69)/2.0 Turbo 4x4 (69)/2.8 V6 Turbo 4x4 (69)/2.8 V6 Turbo OPC 4x4 (69)/1.6 CDTi (69)/2.0 CDTi (69)/2.0 CDTi 4x4 (69)/2.0 Biturbo CDTi 4x4 (69)/2.0 Biturbo CDTi (69)/ 2008>2017, Insignia A Sports Tourer 1.4 (35)/1.4 LPG (35)/1.6 (35)/1.6 SIDI (35)/1.6 Turbo (35)/1.8 (35)/2.0 Turbo (35)/2.0 E85 Turbo (35)/2.0 Turbo 4x4 (35)/2.8 V6 Turbo 4x4 (35)/2.8 V6 Turbo OPC 4x4 (35)/1.6 CDTi (35)/2.0 CDTi (35)/2.0 CDTi 4x4 (35)/2.0 Biturbo CDTi (35)/2.0 Biturbo CDTi 4x4 (35)/ 2008>2017, Meriva B Mpv 1.4 (75)/1.4 LPG (75)/1.3 CDTi (75)/1.6 CDTi (75)/1.7 CDTi (75)/ 2010>2017, Mokka / Mokka X 1.4 (_76)/1.4 LPG (_76)/1.4 4x4 (_76)/1.6 (_76)/1.6 CDTi (_76)/1.6 CDTi 4x4 (_76)/1.7 CDTi (_76)/1.7 CDTi 4x4 (_76)/ 2012>2015, Zafira Tourer C 1.4 (75)/1.4 LPG (75)/1.6 CNG (75)/1.6 (75)/1.6 SIDI (75)/1.8 (75)/1.6 CDTi (75)/2.0 CDTi (75)/2.0 BiTurbo CDTi (75)/ 2011>

GE3044



FEATURES: EVAPORATIVE BOX RESISTENCE

CARACTERÍSTICAS: RESISTENCIA DE LA CAJA EVAPORATIVA

3 2-WAY CONNECTOR | 3 CONECTOR DE 2 VÍAS

REPLACE / REEMPLAZA:

Denso: A43002400; **Fiat:** 51918027

APPLICATION / APLICACIONE:

Fiat: Toro 1.8 2016

GE3045



FEATURES: EVAPORATIVE BOX RESISTENCE

CARACTERÍSTICAS: RESISTENCIA DE LA CAJA EVAPORATIVA

4-WAY CONNECTOR | CONECTOR DE 4 VÍAS

REPLACE / REEMPLAZA:

Ford: AB3919A706AA

APPLICATION / APLICACIONE:

Ford: Ranger: 2.2 TDCi/2.2 TDCi 4x4/3.2 TDCi 4x4/ 2011>

GE3046



FEATURES: EVAPORATIVE BOX RESISTENCE

CARACTERÍSTICAS: RESISTENCIA DE LA CAJA EVAPORATIVA

Resistance / Resistencia: T1 - T2: 3,333Ω

Resistance / Resistencia: T1 - T3: 5,435Ω

REPLACE / REEMPLAZA:

97907-2B000

APPLICATION / APLICACIONE:

Hyundai: Santa Fé: 2.4/2.0 CRDi/2.0 CRDi 4x4/ 2010>2012

GE3047

FEATURES: EVAPORATIVE BOX RESISTENCE
 CARACTERÍSTICAS: RESISTENCIA DE LA CAJA EVAPORATIVA
 DIGITAL AIR | AIRE DIGITAL
 4-WAY CONNECTOR | CONECTOR DE 4 VÍAS
 REPLACE / REEMPLAZA:
Honda: 077800-0960, 79330-SDG-W51
 APPLICATION / APLICACIONE:
Honda: Cr-V Mk 3 Suv: 2.0 i-VTEC 4WD (RE5, RE2)/2.4 i-VTEC 4WD (RE7)/2.2 i-CTDi 4WD (RE6)/ 2006>2012

GE3048

FEATURES: EVAPORATIVE BOX RESISTENCE
 CARACTERÍSTICAS: RESISTENCIA DE LA CAJA EVAPORATIVA
 DIGITAL AIR | AIRE DIGITAL
 2 2/3 WAY CONNECTOR | CONECTOR 2 2/3 VÍAS
 REPLACE / REEMPLAZA:
Toyota: 499300-3341, 89257-12010
 APPLICATION / APLICACIONE:
Toyota: Corolla 1.6/1.8 2002>2008

GE3049

FEATURES: EVAPORATIVE BOX RESISTENCE
 CARACTERÍSTICAS: RESISTENCIA DE LA CAJA EVAPORATIVA
 4-WAY CONNECTOR | CONECTOR 4 VÍAS
 REPLACE / REEMPLAZA:
Nissan: 27150-4M401
 APPLICATION / APLICACIONE:
Nissan: Frontier 2.5 2008>2016

GE3050

FEATURES: EVAPORATIVE BOX RESISTENCE
 CARACTERÍSTICAS: RESISTENCIA DE LA CAJA EVAPORATIVA
Resistance / Resistencia: T1 - T2: 0,433Ω
Resistance / Resistencia: T1 - T3: 1,439Ω
Resistance / Resistencia: T1 - T4: 3,016Ω
 REPLACE / REEMPLAZA:
Nissan: 27150-ED000, 27150-ED50A
 APPLICATION / APLICACIONE:
Nissan: Livina/Grand Livina 1.6/1.8 2009>2014

GE3051

FEATURES: EVAPORATIVE BOX RESISTENCE
 CARACTERÍSTICAS: RESISTENCIA DE LA CAJA EVAPORATIVA
Resistance / Resistencia: T1 - T2: 1,279Ω
Resistance / Resistencia: T1 - T3: 1,176Ω
Resistance / Resistencia: T1 - T4: 0,862Ω
 REPLACE / REEMPLAZA:
Ford: AV1H813647AB
 APPLICATION / APLICACIONE:
Ford: Ecosport 1.5/1.6/2.0 2008>2018

GE3052

FEATURES: EVAPORATIVE BOX RESISTENCE
 CARACTERÍSTICAS: RESISTENCIA DE LA CAJA EVAPORATIVA
 ELECTRONIC AIR | AIRE ELECTRONICO
 6-WAY CONNECTOR | CONECTOR DE 6 VÍAS
 2-WAY WHIP | LÁTIGO DE 2 VÍAS
 REPLACE / REEMPLAZA:
VW: 6Q1 907 521
 APPLICATION / APLICACIONE:
Audi: A2 Hatch 1.4/1.6 FSI/1.2 TDI/1.4 TDI/ 2000>2005;
Seat: Cordoba Mk 2 Saloon 1.2/1.2 12V/1.4 16V/1.6/1.6 16V/2.0/1.4 TDI/1.9 SDI/1.9 TDI/ 2002>2009, Ibiza Mk 4 Hatch 1.2/1.2 12V/1.4 16V/1.6/1.6 16V/1.8 T FR/1.8 T Cupra R/2.0/1.4 TDI/1.9 SDI/1.9 TDI/1.9 TDI Cupra R/ 2002>2009, Ibiza Mk 5 Hatch 1.2/1.4/1.4 TSI/1.6/1.4 TDI/1.6 TDI/1.9 TDI/2.0 TDI/ 2008>2015, Ibiza Iv St 1.2 TSI/1.2/1.4/1.2 TDI/1.6 TDI/ 2010>2015;
Skoda: Fabia Mk 2 Hatch 1.2/1.2 TSI/1.4/1.6/1.2 TDI/1.4 TDI/1.6 TDI/1.9 TDI/ 2006>2014, Fabia Mk 2 Estate 1.2/1.2 TSI/1.4/1.6/1.2 TDI/1.4 TDI/1.6 TDI/1.9 TDI/ 2007>2014, Roomster Mpv 1.2/1.2 TSI/1.4/1.6/1.4 TDI/1.6 TDI/1.9 TDI/ 2006>2015;
VW: Polo Mk 4/4F Hatch 1.2/1.2 12V/1.4 16V/1.4 FSI/1.6 16V/1.8 GTI/1.8 GTI Cup Edition/1.4 TDI/1.9 SDI/1.9 TDI/ 2001>2009, Polo Mk 4 Saloon 1.4/ 2002>2012, Polo 1.2/1.2 TSI/1.4 (6R1)/1.2 TDI/1.6 TDI/ 2009>2014

GE3053

FEATURES: EVAPORATIVE BOX RESISTENCE
 CARACTERÍSTICAS: RESISTENCIA DE LA CAJA EVAPORATIVA
Resistance / Resistencia: T1 - T2: 0,233Ω
 REPLACE / REEMPLAZA:
Fiat: 51799364, 55702358
 APPLICATION / APLICACIONE:
Abarth: Grande Punto 1.4 (199.AXN1B)/ 2007>2010;
Fiat: Bravo Mk 2 Hatch 1.4 (198AXA1B)/1.4 LPG (198AXA1B)/1.4 T-Jet (198AXG1B)/1.4 16V (198AXS1B)/1.4 T-Jet (198AXF1B)/1.9 D Multijet (198AXD1A)/1.9 D Multijet (198AXB1A)/1.9 D Multijet (198AXC1B)/2.0 D Multijet (198AXPIB)/ 2006>2014, Grande Punto 1.2/1.4 (199AXB1A)/1.4 (199AXB11, 199AXB1A, 199BXC1A, 199AXL1A)/1.4 LPG/1.4 T-Jet (199AXM1A, 199BXM1A, 199BXN1A)/1.3 D Multijet/1.3 D Multijet (199.AXD11, 199.AXD1A, 199.AXD1B,...)/1.6 D Multijet/1.9 D Multijet/ 2005>2015, 500: 0.9 (312AXG1A, 312.AXG11)/1.2 (312AXA1A)/1.2 LPG (312AXA1A)/1.4 (312AXC1B, 312CXC1B)/1.3 D Multijet (312AXB1A)/ 2007>

GE3054

FEATURES: EVAPORATIVE BOX RESISTENCE
 CARACTERÍSTICAS: RESISTENCIA DE LA CAJA EVAPORATIVA
 ELECTRONIC AIR | AIRE ELECTRONICO
 2 2/4-WAY CONNECTOR | CONECTOR 2 2/4 VÍAS
 REPLACE / REEMPLAZA:
VW: 1625-5YY0063.D, 52420686, 7L0 907 521B
 APPLICATION / APLICACIONE:
Audi: Q7 3.0 TFSI quattro/3.0 TDI quattro/4.2 TDI quattro/ 2006>2015;
Seat: Alhambra 1.4 TSI/2.0 TSI/2.0 TDI/2.0 TDI 4Drive/ 2010>2011
VW: Alhambra 1.4 TSI/2.0 TSI/2.0 TDI/2.0 TDI 4Drive/ 2010>2011, Amarok 2.0 TSI/2.0 BITDI 4motion/ 2010>2016, Sharan 2.0 TSI/2.0 TDI/2.0 TDI 4motion/ 2010>2019, Touareg 3.2 V6/4.2 V8/4.2 V8 FSI/6.0 W12/2.5 R5 TDI/3.0 V6 TDI/5.0 V10 TDI/5.0 R50 TDI/ 2002>2010, Transporter T5 Minibus 2.0/3.2 V6/3.2 V6 4motion/1.9 TDI/2.0 TDI/2.0 TDI 4motion/2.5 TDI/2.5 TDI 4motion/ 2003>2015

GE3055



FEATURES: EVAPORATIVE BOX RESISTENCE
 CARACTERÍSTICAS: RESISTENCIA DE LA CAJA EVAPORATIVA
2 5/2-WAY CONNECTOR | 2 CONECTOR DE 5/2 VÍAS
 REPLACE / REEMPLAZA:
Renault: 271500889R, A51004200
 APPLICATION / APLICACIONE:
Dacia: Dokker Estate 1.2 TCe (KEM0, KEAY)/1.6/1.6 LPG/1.5 dCi / Blue dCi 75 (KEAJ, KEAH, KEJW)/1.5 dCi (KEAJ, KEAH)/1.5 Blue dCi 95 (KEJL) / 2012>, Dokker Express Box 1.2 TCe 115 (FEM0)/1.2 TCe 115 (FEAY)/1.6/1.6 LPG/1.5 dCi 75 / Blue dCi 75 (FEJW, FEAH)/1.5 dCi (FEAJ) / 2012>, Lodgy 1.2 TCe (JSAY, JSM0)/1.6/1.6 LPG/1.6 SCe 100/1.5 dCi/1.5 Blue dCi 95 (JSJL)/1.5 Blue dCi 115 (JSJT) / 2012>

GE3056



FEATURES: EVAPORATIVE BOX RESISTENCE
 CARACTERÍSTICAS: RESISTENCIA DE LA CAJA EVAPORATIVA
Resistance / Resistencia: T1 - T2: 0,287Ω
 REPLACE / REEMPLAZA:
Denso: 51905875; **Fiat:** KRA51002400, M51001800
 APPLICATION / APLICACIONE:
Fiat: Grand Siena/ Siena 1.0/1.4/1.6 2012>2016

GE3057



FEATURES: EVAPORATIVE BOX RESISTENCE
 CARACTERÍSTICAS: RESISTENCIA DE LA CAJA EVAPORATIVA
2-WAY CONNECTOR | CONECTOR DE 2 VÍAS
 REPLACE / REEMPLAZA:
Nissan: 27226-70T03, 277614BA0A, 70T032E243, 70T038E17
 APPLICATION / APLICACIONE:
Nissan: Juke 1.2 DIG-T/1.6/1.6 DIG-T/1.6 DIG-T 4x4/1.6 DIG-T NISMO/1.6 DIG-T NISMO 4x4/1.6 DIG-T NISMO RS 4x4/1.6 DIG-T NISMO RS/1.5 dCi/ 2010>2014, Qashqai 1.6/2.0/2.0 All-wheel Drive/1.5 dCi/1.6 dCi/1.6 dCi All-wheel Drive/2.0 dCi/2.0 dCi All-wheel Drive/ 2007>2013, X-Trail 2.0 FWD/2.0/2.5 4x4/2.0 dCi 4x4/2.0 dCi FWD/2.0 dCi/ 2007>2013

GE3058



FEATURES: EVAPORATIVE BOX RESISTENCE
 CARACTERÍSTICAS: RESISTENCIA DE LA CAJA EVAPORATIVA
DIGITAL AIR | AIRE DIGITAL
2 2/3 WAY CONNECTOR | CONECTOR 2 2/3 VÍAS
 REPLACE / REEMPLAZA:
Ford: 1750865, A6005-007-00, AV6N-19E624-BA/B4
 APPLICATION / APLICACIONE:
Ford: Focus 1.6/2.0 2013>2019

GE3059



FEATURES: EVAPORATIVE BOX RESISTENCE
 CARACTERÍSTICAS: RESISTENCIA DE LA CAJA EVAPORATIVA
Resistance / Resistencia: T1 - T2: 0,688Ω
 REPLACE / REEMPLAZA:
Renault: 8200045082
 APPLICATION / APLICACIONE:
Dacia: Logan Saloon 1.6 Bifuel/1.6 (LSOB, LSOD, LSOE, LSOH)/1.5 dCi (LSOK) / 2004>, Logan Mcv Estate 1.6 16V Hi-Flex/ 2009>;
Renault: Clio Mk 3 Hatch 1.2 16V (BR0R, BR1D, BR1L, CR0R)/1.2 16V (BR02, BR0J, BR11, CR02, CR0J, CR11)/1.2 16V/1.4 16V/1.6 16V (BR09, BR0T, CR09, CR0T)/1.6 16V (BR05, BR0B, BR0Y, BR15, BR1J, BR1M, BR1Y, CR0B,...)/2.0 16V (BR0C, BR0K, CR0C, CR0K)/2.0 16V Sport (CR0N, CR1P)/1.5 dCi (C/BR0G, C/BR1G)/1.5 dCi (BR17, CR17)/1.5 dCi (BR0H, CR0H, CR1S, BR1S) / 2005>2007, Espace Mk 4 2.0 (JK09)/2.0 Turbo (JK0A, JK0B, JK0N)/2.0 (JK0A, JK1D, JK0N)/3.5 V6 (JK0M, JK0F, JK0P, JK0S, JK0W)/1.9 dCi (JK0U)/1.9 dCi (JK0U, JK0G)/2.0 dCi (JK02, JK03)/2.0 dCi (JK01, JK02, JK1J, JK1K, JK1H)/2.0 dCi (JK03, JK04, JK1C, JK1G, JK1J, JK1K)/2.2 dCi (JK07)/2.2 dCi (JK0H)/3.0 dCi (JK0J, JK0V)/3.0 dCi (JK0E, JK0Y) / 2002>2005, Laguna Mk 1 Hatch 1.6 16V (B568, B561)/1.8 (B56S/T/0)/1.8 (B56Z)/1.8 16V (B563, B564)/2.0 16V (B56D/M)/3.0 24V (B56V)/1.9 dTi (B56J)/2.2 dT (B569) / 1995>201, Laguna Mk 1 Estate 1.6 16V (K568)/1.8 (K56S/T/0)/1.8 (K56Z)/1.8 16V (K563, K564)/2.0 (K56C/H)/2.0 16V (K56D/M)/3.0 24V (K56V)/3.0 (K56R, K565)/1.9 dTi (K56J)/2.2 dT (K569) / 1995>201, Laguna Mk 2 Hatch 1.6 16V (BG0A, BG0L)/1.6 16V (BG1G, BG1H)/1.8 16V (BG06, BG0J, BG0M)/1.8 16V (BG0B, BG0M)/1.8 16V (BG0B, BG0C, BG0J, BG0M, BG0V)/2.0 16V (BG00, BG0K, BG0P, BG0W)/2.0 16V IDE (BG0N)/2.0 16V Turbo (BG0S, BG1L, BG1M)/2.0 16V (BG03, BG0Z, BG0T, BG1Y)/3.0 V6 24V (BG01, BG02, BG0D, BG0Y)/1.9 dCi (BG05)/1.9 dCi (BG0R)/1.9 dCi (BG0E)/1.9 dCi (BG1A, BG1W)/1.9 dCi (BG08, BG0G)/1.9 dCi (BG1A, BG1V)/2.0 dCi (BG1T)/2.0 dCi (BG14, BG1S)/2.2 dCi/2.2 dCi (BG0F) / 2001>2007, Laguna Mk 2 Estate 1.6 16V (KG0A, KG0L)/1.6 16V/1.8 16V (KG0J)/1.8 16V (KG0B, KG0M)/1.8 16V/2.0 16V (KG00, KG0K, KG0W, KG0P)/2.0 16V IDE (KG0N)/2.0 16V Turbo (KG0S, KG1L, KG03)/2.0 16V (KG03, KG0Z, KG0T, KG1Y)/2.0 16V (KG1Y)/3.0 V6 24V (KG0D)/1.9 dCi (KG05)/1.9 dCi (KG0E, KG0R)/1.9 dCi (KG0E)/1.9 dCi (KG1A, KG1W)/1.9 dCi (KG0G)/1.9 dCi (KG1V)/2.0 dCi (KG1T)/2.0 dCi (KG1S)/2.2 dCi/2.2 dCi (KG0F) / 2001>2007, Megane Mk 1 Hatch 1.4 Eco (BA0T)/1.4 e (BA0E, BA0V)/1.6 i (BA0L)/1.6 e (BA0F, BA0S)/2.0 i (BA0G)/2.0 16V (BA0H)/1.9 D Eco (BA0A, BA0U, BA0R)/1.9 dT (B/SA0K, B/SA0Y)/1.9 TDI/1.9 dTi (BA08, BA0N) / 1996>1999, Megane Classic Saloon 1.4 (LA0E, LA0V)/1.6 i (LA0L)/1.6 e (LA0F, LA0S)/2.0 i (LA07, LA0G)/1.9 D (LA0A, LA0U, LA0R)/1.9 dT (LA0K, LA0Y)/1.9 TDI/1.9 dTi (LA08, LA0N) / 1996>1999, Scenic Mk 1 Mpv 1.4 i (JA0E)/1.6 i (JA0L)/1.6 e (JA0F)/1.6 16V (JA0B, JA04, JA11)/2.0 i (JA0G)/1.9 D (JA0J)/1.9 dT (JA0K, JA0Y)/1.9 dTi (JA0N) / 1996>1999, Modus Hatch 1.2 (FP0C, FP0K, FP0P)/1.2 (JP0C, JP0K, FP0C, FP0K, FP0P, JP0P, JP0T)/1.2 16V (JP0V)/1.4 (JP01, JP0U)/1.6 (JP0L, JP0V)/1.6 (JP03, JP0B, JP0U, JP0Y, JP1G)/1.5 dCi (FP0G, JP0G)/1.5 dCi 75/1.5 dCi (FP0F, JP0F)/1.5 dCi (JP0G, JP0H) / 2004>, Vel Satis Mpv 2.0 16V Turbo (BJ0K)/2.0 16 V Turbo/3.5 V6 (BJ0R, BJ0V, BJ0U)/2.0 dCi (BJ03)/2.0 dCi (BJ03, BJ0B)/2.2 dCi (BJ0M)/2.2 dCi (BJ0H)/2.2 dCi (BJ0E, BJ0F, BJ0G, BJ0H)/2.2 dCi (BJ0E, BJ0F)/3.0 dCi (BJ0J, BJ0N)/3.0 dCi (BJ0S) / 2002>

GE3060



FEATURES: EVAPORATIVE BOX RESISTENCE
 CARACTERÍSTICAS: RESISTENCIA DE LA CAJA EVAPORATIVA
Resistance / Resistencia: T1 - T2: 1,753Ω
Resistance / Resistencia: T1 - T3: 3,020Ω
Resistance / Resistencia: T1 - T4: 0,637Ω
 REPLACE / REEMPLAZA:
VW: 5U0819022, BC2468107370RC
 APPLICATION / APLICACIONE:
VW: Gol 1.0 2005>2014

GE3061



FEATURES: EVAPORATIVE BOX RESISTENCE
 CARACTERÍSTICAS: RESISTENCIA DE LA CAJA EVAPORATIVA
Resistance / Resistencia: T1 - T2: 1,497Ω
Resistance / Resistencia: T1 - T3: 3,245Ω
Resistance / Resistencia: T1 - T4: 0,983Ω
 REPLACE / REEMPLAZA:
Nissan: 27150EY00A, 4226E80
 APPLICATION / APLICACIONE:
Nissan: Np300 Navarra Pickup 2.3 dCi (D231)/2.3 dCi 4x4 (D231) / 2015>

GE3062

FEATURES: EVAPORATIVE BOX RESISTENCE
 CARACTERÍSTICAS: RESISTENCIA DE LA CAJA EVAPORATIVA
 Resistance / Resistencia: T1 - T2: 0,465Ω
 Resistance / Resistencia: T1 - T3: 0,880Ω
 Resistance / Resistencia: T1 - T4: 1,757Ω
 REPLACE / REEMPLAZA:
 ...
 APPLICATION / APLICACIONE:
 Universal

GE3063

FEATURES: EVAPORATIVE BOX RESISTENCE
 CARACTERÍSTICAS: RESISTENCIA DE LA CAJA EVAPORATIVA
 Resistance / Resistencia: T1 - T2: 0,098Ω
 Resistance / Resistencia: T1 - T3: 0,620Ω
 Resistance / Resistencia: T1 - T4: 0,983Ω
 Resistance / Resistencia: T1 - T5: 1,992Ω
 REPLACE / REEMPLAZA:
 GM: 1845784, 90230931
 APPLICATION / APLICACIONE:
 Opel: Omega A Saloon: 1.8 N (F19, M19, N19)/ 1986>1988

GE3064

FEATURES: FAN RESISTENCE
 CARACTERÍSTICAS: RESISTENCIA DEL VENTILADOR
 Resistance / Resistencia: T1 - T2: 0,840Ω
 REPLACE / REEMPLAZA:
 Hyundai: 2J1306C
 APPLICATION / APLICACIONE:
 Hyundai: Hb-20 1.0

GE3065

FEATURES: EVAPORATIVE BOX RESISTENCE
 CARACTERÍSTICAS: RESISTENCIA DE LA CAJA EVAPORATIVA
 Resistance / Resistencia: T1 - T2: 1,555Ω
 Resistance / Resistencia: T1 - T3: 0,545Ω
 Resistance / Resistencia: T1 - T4: 0,255Ω
 REPLACE / REEMPLAZA:
 Audi/ VW: 1J0-819-022A
 APPLICATION / APLICACIONE:
 Audi: A4 1.8/2.4 1995>2000

GE3066

FEATURES: EVAPORATIVE BOX RESISTENCE
 CARACTERÍSTICAS: RESISTENCIA DE LA CAJA EVAPORATIVA
 2 2/3-WAY CONNECTORS | 2 CONECTORES DE 2/3 VÍAS
 REPLACE / REEMPLAZA:
 1TD959455
 APPLICATION / APLICACIONE:
 VW: Jetta 2.5 2006>2007

GE3067

FEATURES: FAN RESISTENCE
 CARACTERÍSTICAS: RESISTENCIA DEL VENTILADOR
 Resistance / Resistencia: T1 - T2: 0,882Ω
 REPLACE / REEMPLAZA:
 Ford: 541959493, PPWA-092
 APPLICATION / APLICACIONE:
 Ford: Verona 1.6/1.8 1990>1993

GE3068

FEATURES: EVAPORATIVE BOX RESISTENCE
 CARACTERÍSTICAS: RESISTENCIA DE LA CAJA EVAPORATIVA
 Resistance / Resistencia: T1 - T2: 2,460Ω
 Resistance / Resistencia: T1 - T3: 1,050Ω
 Resistance / Resistencia: T1 - T4: 0,303Ω
 REPLACE / REEMPLAZA:
 Renault: 6001552013
 APPLICATION / APLICACIONE:
 Renault: Logan 1.0/1.6 2007>2013

GE3069

FEATURES: EVAPORATIVE BOX RESISTENCE
 CARACTERÍSTICAS: RESISTENCIA DE LA CAJA EVAPORATIVA
 MIN. VOLTAGE 4.2 V | VOLTAJE MIN. 4,2 V
 MAX. 5.2 V | MAX. 5,2 V
 4-WAY CONNECTOR | CONECTOR DE 4 VÍAS
 REPLACE / REEMPLAZA:
 Mitsubishi: MR576271
 APPLICATION / APLICACIONE:
 Mitsubishi: Pajero li 3.2 2000>2007

GE3070

FEATURES: EVAPORATIVE BOX RESISTENCE
 CARACTERÍSTICAS: RESISTENCIA DE LA CAJA EVAPORATIVA
 TRANSISTORIZED | TRANSISTORIZADO
 MIN. VOLTAGE 2.2 V | VOLTAJE MIN. 2,2 V
 MAX. 3.7 V | MAX. 3,7 V
 4-WAY CONNECTOR | CONECTOR DE 4 VÍAS
 REPLACE / REEMPLAZA:
 Honda: 79330-S5J-M01
 APPLICATION / APLICACIONE:
 Honda: Accord Mk 8 Saloon 2.0 i (CU1)/2.4 i (CU2)/2.2 i-DTEC (CU3)/ 2008>2015, Accord Mk 8 Estate 2.0 i (CW1)/2.4 i (CW2)/2.2 i-DTEC (CW3)/ 2008>, Civic Mk 6 Hatch 1.4 i/1.4 iS (EP1)/1.6 i/2.0 i Sport/2.0 Type-R/1.7 CTDi/ 2001>2005, Civic Mk 6 Saloon 1.3 IMA (ED9, ES9)/1.4 (ES4)/1.6/ 2000>2005, Civic Mk 6 Coupe 1.6 i/1.7 i/1.7 i VTEC/ 2001>2005, Cr-V Mk 2 Suv: 2.0 (RD5)/2.2 CTDi (RD9)/ 2001>2007, Stream Mpv 1.7 16V (RN1)/2.0 16V (RN3)/ 2001>2006;
 Suzuki: Sx4 1.5 (RW 415)/1.5 VVT (RW 415)/1.5 VVT 4x4 (RW 415)/1.6 VVT (RW 416)/1.6 VVT 4x4 (RW 416)/1.6 DDiS (RW 416D)/1.9 DDiS (RW 419D)/1.9 DDiS 4x4 (RW 419D)/2.0 DDiS (RW 420D)/2.0 DDiS 4x4 (RW 420D)/ 2006>2010

GE3071

FEATURES: EVAPORATIVE BOX RESISTENCE
 CARACTERÍSTICAS: RESISTENCIA DE LA CAJA EVAPORATIVA
 1R68
 0R26 OHM
 0R51
 4-WAY CONNECTOR | CONECTOR DE 4 VÍAS
 REPLACE / REEMPLAZA:
 Nissan: 1916E39
 APPLICATION / APLICACIONE:
 Nissan: Frontier 2.8 2002>2005

GE3072



FEATURES: EVAPORATIVE BOX RESISTANCE
 CARACTERÍSTICAS: RESISTENCIA DE LA CAJA EVAPORATIVA
 Resistance / Resistencia: T1 - T2: 2,402Ω
 Resistance / Resistencia: T1 - T3: 3,632Ω
 Resistance / Resistencia: T1 - T4: 8,934Ω
 REPLACE / REEMPLAZA:
Mercedes-Benz: SK504010705
 APPLICATION / APLICACIONE:
MB: Axor 2006>

GE3073



FEATURES: EVAPORATIVE BOX RESISTANCE
 CARACTERÍSTICAS: RESISTENCIA DE LA CAJA EVAPORATIVA
 Resistance / Resistencia: T1 - T2: 1,655Ω
 Resistance / Resistencia: T1 - T3: 1,027Ω
 Resistance / Resistencia: T1 - T4: 1,503Ω
 REPLACE / REEMPLAZA:
Honda: 79330-SAA-J01
 APPLICATION / APLICACIONE:
Honda: Jazz Mk 2 Hatch 1.2 i-DSI (GD5, GE2)/1.3 iDSi (GD1)/2002>2008

GE3074



FEATURES: EVAPORATIVE BOX RESISTANCE
 CARACTERÍSTICAS: RESISTENCIA DE LA CAJA EVAPORATIVA
 Resistance / Resistencia: T1 - T2: 0,004Ω
 Resistance / Resistencia: T1 - T3: 0,155Ω
 Resistance / Resistencia: T1 - T4: 0,393Ω
 Resistance / Resistencia: T1 - T5: 1,210Ω
 REPLACE / REEMPLAZA:
 ...
 APPLICATION / APLICACIONE:
 Truck (Universal)

GE3075



FEATURES: EVAPORATIVE BOX RESISTANCE
 CARACTERÍSTICAS: RESISTENCIA DE LA CAJA EVAPORATIVA
 Resistance / Resistencia: T1 - T2: 2,795Ω
 Resistance / Resistencia: T1 - T3: 0,301Ω
 Resistance / Resistencia: T1 - T4: 0,644Ω
 REPLACE / REEMPLAZA:
GM: 15094285
 APPLICATION / APLICACIONE:
GM: S10 2.4/2.8 2003>2012

GE3076



FEATURES: EVAPORATIVE BOX RESISTANCE
 CARACTERÍSTICAS: RESISTENCIA DE LA CAJA EVAPORATIVA
 MIN. VOLTAGE 2.2 V | VOLTAJE MIN. 2,2 V
 MAX. 3.7 V | MAX. 3,7 V
 4-WAY CONNECTOR | CONECTOR DE 4 VÍAS
 REPLACE / REEMPLAZA:
Honda: 077800-0682, 077800-0930, 077800-1980,
 79330-SDG-W51
 APPLICATION / APLICACIONE:
Honda: Cr-V Mk 3 Suv 2.0 i-VTEC 4WD (RE5, RE2)/2.4 i-VTEC
 4WD (RE7)/2.2 i-CTDi 4WD (RE6)/2.2 i-DTEC 4WD (RE6)/ 2006>2012

GE3077



FEATURES: EVAPORATIVE BOX RESISTANCE
 CARACTERÍSTICAS: RESISTENCIA DE LA CAJA EVAPORATIVA
 Resistance / Resistencia: T1 - T2: 0,420Ω
 Resistance / Resistencia: T1 - T3: 2,265Ω
 REPLACE / REEMPLAZA:
 ...
 APPLICATION / APLICACIONE:
 Truck (Universal)

GE3078



FEATURES: FAN RESISTANCE
 CARACTERÍSTICAS: RESISTENCIA DEL VENTILADOR
 Resistance / Resistencia: T1 - T2: 0,313Ω
 REPLACE / REEMPLAZA:
Fiat: EZT31280
 APPLICATION / APLICACIONE:
Fiat: Stilo 1.8/2.4 2002>2008

GE3079



FEATURES: FAN RESISTANCE
 CARACTERÍSTICAS: RESISTENCIA DEL VENTILADOR
 Resistance / Resistencia: T1 - T2: 1,022Ω
 Resistance / Resistencia: T1 - T3: 0,962Ω
 Resistance / Resistencia: T1 - T4: 0,671Ω
 REPLACE / REEMPLAZA:
BMW: 64118391749
 APPLICATION / APLICACIONE:
BMW: 3-Series Saloon 316 i/318 i/318 is/320 i/323 i/325 i/328 i/M3
 3.2/318 tds/325 td/325 tds/ 1990>1998, 3-Series Compact 318 tds/
 1995>200, 3-Series Coupe 316 i/318 is/320 i/323 i/325 i/328 i/M3 3.0/
 M3 3.2/ 1991>1999, 3-Series Convertible 318 i/320 i/323 i/325 i/328 i/
 M3 3.0/M3 3.2/ 1993>1999, 3-Series Estate 316 i/318 i/320 i/323 i/328
 i/318 tds/325 tds/ 1995>1999

GE3080



FEATURES: EVAPORATIVE BOX RESISTANCE
 CARACTERÍSTICAS: RESISTENCIA DE LA CAJA EVAPORATIVA
 Resistance / Resistencia: T1 - T2: 1,900Ω
 Resistance / Resistencia: T1 - T3: 0,650Ω
 Resistance / Resistencia: T1 - T4: 0,479Ω
 REPLACE / REEMPLAZA:
 ...
 APPLICATION / APLICACIONE:
Mitsubishi: L-200 2.5 2004>2011

GE3081



FEATURES: EVAPORATIVE BOX RESISTANCE
 CARACTERÍSTICAS: RESISTENCIA DE LA CAJA EVAPORATIVA
 Resistance / Resistencia: T1 - T2: 53,01kΩ
 Resistance / Resistencia: T1 - T3: 1,131kΩ
 REPLACE / REEMPLAZA:
Mitsubishi: 27150-1N760, 7802A006, 92495-V92204
 APPLICATION / APLICACIONE:
Nissan: Almera Hatch 1.4 S,GX,LX/1.4/ 1995>2000

GE3082

FEATURES: FAN RESISTENCE
 CARACTERÍSTICAS: RESISTENCIA DEL VENTILADOR
 Resistance / Resistencia: T1 - T2: 1,051Ω
 REPLACE / REEMPLAZA:
 VW: PPWA039, ZBC959.493
 APPLICATION / APLICACIONE:
 VW: Gol 1.6/1.8 1985>1997

GE3083

FEATURES: FAN RESISTENCE
 CARACTERÍSTICAS: RESISTENCIA DEL VENTILADOR
 Resistance / Resistencia: T1 - T2: 3,379Ω
 Resistance / Resistencia: T1 - T3: 0,269Ω
 Resistance / Resistencia: T1 - T4: 0,981Ω
 REPLACE / REEMPLAZA:
 Ford: 3259592631, PPWA-113
 APPLICATION / APLICACIONE:
 Ford: Versailles 1.8/2.0 1991>1996

GE3084

FEATURES: FAN RESISTENCE
 CARACTERÍSTICAS: RESISTENCIA DEL VENTILADOR
 Resistance / Resistencia: T1 - T2: 0,263Ω
 REPLACE / REEMPLAZA:
 VW: 377.971.505.F, PPWA094
 APPLICATION / APLICACIONE:
 VW: Gol 1.0/1.6/1.8/2.0 1995>2006

GE3085

FEATURES: FAN RESISTENCE
 CARACTERÍSTICAS: RESISTENCIA DEL VENTILADOR
 Resistance / Resistencia: T1 - T2: 0,484Ω
 REPLACE / REEMPLAZA:
 VW: 327.971.505.1, PPWA-095
 APPLICATION / APLICACIONE:
 VW: Santana 1.8 1984>1989

GE3086

FEATURES: FAN RESISTENCE
 CARACTERÍSTICAS: RESISTENCIA DEL VENTILADOR
 Resistance / Resistencia: T1 - T2: 0,192Ω
 REPLACE / REEMPLAZA:
 GM: 3134503070, 94718195
 APPLICATION / APLICACIONE:
 VW: Santana 1.8 1984>1989

GE3087

FEATURES: FAN RESISTENCE
 CARACTERÍSTICAS: RESISTENCIA DEL VENTILADOR
 Resistance / Resistencia: T1 - T2: 0,290Ω
 REPLACE / REEMPLAZA:
 Ford: 91AB9A819AC
 APPLICATION / APLICACIONE:
 Ford: Escort Mk 5 Hatch 1.3/1.4/1.6 i 16V/1.6/1.8 16V XR3i/1.8 XR3i 16V 4x4/RS 2000/RS 2000 4x4/1.8 D/1.8 TD/ 1990>1995, Escort Mk 5 Estate 1.3/1.4/1.6 i 16V/1.6/1.8 16V/1.8 D/1.8 TD/ 1990>1995, Escort Mk 5 Convertible 1.4/1.4 i/1.6 i 16V/1.6 16V XR3i/1.8 16V XR3i/1990>1995, Escort Mk 6 Saloon 1.3/1.4/1.6 i 16V/1.8 i 16V/1.8 D/1.8 TD/ 1993>1995, Escort Mk 7 Hatch 1.3/1.4/1.6 i 16V/1.6 16V/1.6 16V 4x4/1.8 16V/RS 2000/RS 2000 4x4/1.8 D/1.8 Turbo D/1.8 TD/ 1995>1998, Escort Mk 7 Saloon 1.3/1.4/1.6 i 16V/1.8 16V/1.8 D/1.8 Turbo D/1.8 TD/ 1995>1999, Escort Mk 7 Estate 1.3/1.4/1.6 i 16V/1.6 16V/1.8 16V/1.8 D/1.8 Turbo D/1.8 TD/ 1995>1999, Escort Mk 7 Convertible 1.4/1.6 16V XR3i/1.8 16V XR3i/1.8 Turbo D/1.8 TD/ 1995>1999, Escort Mk 7 Hatch 1.6 16V/1.8 TD/ 1998>2000, Escort Mk 7 Estate 1.6 16V/1.8 TD/ 1999>2000, Orion Mk 3 Saloon 1.3/1.4/1.6/1.8 i 16V/1990>1993

GE3088

FEATURES: EVAPORATIVE BOX RESISTENCE
 CARACTERÍSTICAS: RESISTENCIA DE LA CAJA EVAPORATIVA
 Resistance / Resistencia: T1 - T2: 1,626Ω
 Resistance / Resistencia: T1 - T3: 1,034Ω
 Resistance / Resistencia: T1 - T4: 1,787Ω
 REPLACE / REEMPLAZA:
 Toyota: 8713802060
 APPLICATION / APLICACIONE:
 Toyota: Hilux 2.7/2.5/3.0 2008>2015

GE3089

FEATURES: EVAPORATIVE BOX RESISTENCE
 CARACTERÍSTICAS: RESISTENCIA DE LA CAJA EVAPORATIVA
 Resistance / Resistencia: IO - M1: 1,045Ω
 Resistance / Resistencia: M1 - 2M: 0,711Ω
 Resistance / Resistencia: M2 - H1: 0,321Ω
 Resistance / Resistencia: IO - H1: 2,075Ω
 REPLACE / REEMPLAZA:
 Honda: 79330-SR3-A01
 APPLICATION / APLICACIONE:
 Honda: Civic 1.5/1.6 1991>1995

GE3090



FEATURES: EVAPORATIVE BOX RESISTANCE
 CARACTERÍSTICAS: RESISTENCIA DE LA CAJA EVAPORATIVA
Resistance / Resistencia: T1 - T2: 0,293Ω
Resistance / Resistencia: T1 - T3: 0,915Ω
Resistance / Resistencia: T1 - T4: 2,569Ω
REPLACE / REEMPLAZA:
Ford: F57H19A706-BA
APPLICATION / APLICACIONE:
Ford: Ranger 2.3/2.5/2.8/4.0 1997>2009

GE3091



FEATURES: EVAPORATIVE BOX RESISTANCE
 CARACTERÍSTICAS: RESISTENCIA DE LA CAJA EVAPORATIVA
Resistance / Resistencia: T1 - T2: 2,119Ω
Resistance / Resistencia: T1 - T3: 3,066Ω
Resistance / Resistencia: T1 - T4: 3,436Ω
REPLACE / REEMPLAZA:
Fiat: 1306600080
APPLICATION / APLICACIONE:
Fiat: Ducato Minibus 2.0 Panorama/Combinato/2.0 4x4/1.9 D/1.9 TD/1.9 D Combinato/1.9 TD Combinato/1.9 TD Panorama/Combinato/2.0 JTD/2.5 D Combinato/2.5 TDI Panorama/Combinato/2.5 TDI 4x4/2.8 D/2.8 TDI/2.8 TDI 4x4/2.8 JTD/2.8 JTD 4x4/ 2000>2002, Ducato Van: 2.0/1.9 D/1.9 TD/1.9 TD CAT/2.0 4x4/2.5 D/2.5 TDI/2.5 TDI 4x4/2.8 JTD/2.8 JTD 4x4/2.8 D/2.8 D 4x4/2.8 TDI/2.8 TDI 4x4/ 2000>2002, Ducato Flatbed 2.0/1.9 D/1.9 TD/1.9 TD CAT/2.5 D 4x4/2.5 TD/2.5 D/2.5 TDI/2.5 TDI 4x4/2.8 JTD/2.8 JTD 4x4/2.8 D/2.8 TDI/2.8 TDI 4x4/2.8 D/2.8 TDI/ 2000>1998, Ducato Minibus 2.0/2.0 4x4/2.0 Bipower/2.0 JTD/2.3 JTD/2.8 JTD/2.8 JTD 4x4/ 2002>2006, Ducato Van: 2.0/2.0 Bipower/2.0 JTD/2.0 4x4/2.3 JTD/2.8 JTD 4x4/2.8 JTD Power/ 2002>2006, Ducato Flatbed 2.0/2.0 JTD/2.3 JTD/2.8 JTD/2.8 JTD 4x4/2.8 JTD Power/ 2002>2006

GE3092



FEATURES: EVAPORATIVE BOX RESISTANCE
 CARACTERÍSTICAS: RESISTENCIA DE LA CAJA EVAPORATIVA
0R25
0R7 OHM
2R85
REPLACE / REEMPLAZA:
Renault: 7701046943
APPLICATION / APLICACIONE:
Renault: Scenic Mk 1 Mpv 1.4 i (JA0E)/1.6 i (JA0L)/1.6 e (JA0F)/2.0 i (JA02, JA0G)/2.0 i (JA0G)/1.9 D (JA0J)/1.9 dTi (JA0N)/ 1996>1999, Scenic Mk 1 Re-Style Mpv 1.4 16V (JA0D, JA1H, Ja0W, JA10)/1.9 D (JA0J, FA0J)/ 1999>2003

GE3093



FEATURES: EVAPORATIVE BOX RESISTANCE
 CARACTERÍSTICAS: RESISTENCIA DE LA CAJA EVAPORATIVA
Resistance / Resistencia: T1 - T2: 0,003Ω
Resistance / Resistencia: T1 - T3: 2711kΩ
Resistance / Resistencia: T1 - T4: 2712kΩ
REPLACE / REEMPLAZA:
Renault: 7701206351
APPLICATION / APLICACIONE:
Renault: Clio Mk 2 Hatch 1.2 (BB0A, BB0F, BB10, BB1K, BB28, BB2D, BB2H, CB0A,.../1.4 (B/CB0C, B/CB0S)/1.4 16V (B/CB0L)/1.4 16V (B/CB0P)/1.6 (B/CB0D)/1.6 16V (BB01, BB0H, BB0T, BB14, BB1D, BB1R, BB2KL, BB3G.../2.0 16V Sport (CB0M)/1.9 D (B/CB0E)/1.9 dTi (B/CB0U)/ 2000>2008, Thalia 1 1.2 16V/1.4/1.4 16V/1.5 dCi/ 2000>

GE3094



FEATURES: EVAPORATIVE BOX RESISTANCE
 CARACTERÍSTICAS: RESISTENCIA DE LA CAJA EVAPORATIVA
0R41
1R72 OHM
3R70
REPLACE / REEMPLAZA:
Renault: 7701207717
APPLICATION / APLICACIONE:
Renault: Megane Mk 2 Hatch 1.4 16V/1.4 16V (BM0B, CM0B)/ 1.6/1.6 Flex-Fuel/1.6 16V/1.6 16V (BM0C, CM0C)/2.0 16V (BM0U, CM0U)/2.0 16V Turbo/2.0/2.0 Renault Sport/1.5 dCi (BM0F, BM0T, BM2B, CM0F, CM0T)/1.5 dCi (BM1F, CM1F)/1.5 dCi (BM02, BM13, BM2A, CM02, CM13)/1.5 dCi (BM16, CM16)/1.5 dCi (BM1E, CM1E)/ 1.9 dCi/1.9 dCi (BM0G, CM0G)/2.0 dCi (BM1K, CM1K)/2.0 dCi/ 2002>2009, Megane Mk 2 Saloon 1.4/1.6/1.6 16V (LM1R, LM0C)/ 2.0/1.5 dCi (LM0F, LM0T, LM2B)/1.5 dCi (LM1F)/1.5 dCi (LM02, LM13, LM2A)/1.5 dCi (LM16)/1.5 dCi (LM1E)/1.9 dCi/1.9 dCi (LM14, LM1D)/1.9 dCi (LM0G, LM1G, LM2C)/2.0 dCi/ 2003>2010, Megane Mk 2 Estate 1.4/1.6 16V/1.6 16V Hi-Flex/1.6/2.0/1.5 dCi (KM0F, KM0T, KM2B)/1.5 dCi (KM1F)/1.5 dCi (KM02, KM13)/1.5 dCi (KM16)/1.5 dCi (KM1E)/1.9 dCi/2.0 dCi/ 2003>2009, Megane Mk 2 Convertible 1.6 16V/1.6/2.0/2.0 16V Turbo/1.5 dCi (EM16)/1.5 dCi (EM1E)/1.9 dCi/2.0 dCi/ 2003>2009

GE3095



FEATURES: EVAPORATIVE BOX RESISTANCE
 CARACTERÍSTICAS: RESISTENCIA DE LA CAJA EVAPORATIVA
0R25
0R70 OHM
2R85
REPLACE / REEMPLAZA:
Renault: 4L3Z19A706AA, 7701046941, 7701048356
APPLICATION / APLICACIONE:
Renault: Scenic Mk 1 Mpv 1.4 i (JA0E)/1.6 i (JA0L)/1.6 e (JA0F)/2.0 i (JA02, JA0G)/2.0 i (JA0G)/1.9 D (JA0J)/1.9 dTi (JA0N)/ 1996>1999, Scenic Mk 1 Re-Style Mpv 1.4 16V (JA0D, JA1H, Ja0W, JA10)/1.6 (JA00, JA16, JA15, JA19, JA1V, JA2B, JA2C, JA0B)/1.6 BiFuel (JA04)/1.8 16V (JA12, JA1R, JA1M, JA1A)/1.9 D (JA0J, FA0J)/1.9 dTi (JA1U)/1.9 dTi (JA0N)/1.9 dCi (JA05, JA1F)/1.9 dCi RX4/ 2000>2003

EMS
RESISTENCIA | RESISTENCIA

GE3096

FEATURES: EVAPORATIVE BOX RESISTENCE

CARACTERÍSTICAS: RESISTENCIA DE LA CAJA EVAPORATIVA

Resistance / Resistencia: T1 - T2: 0,013Ω

Resistance / Resistencia: T1 - T3: 0,370Ω

REPLACE / REEMPLAZA:

...

APPLICATION / APLICACIONE:
Volvo: Truck 1984>

GE3097

FEATURES: EVAPORATIVE BOX RESISTENCE

CARACTERÍSTICAS: RESISTENCIA DE LA CAJA EVAPORATIVA

Resistance / Resistencia: T1 - T2: 2,949Ω

Resistance / Resistencia: T1 - T3: 3,806Ω

Resistance / Resistencia: T1 - T4: 16,939Ω

Resistance / Resistencia: T1 - T6: 4,765Ω

REPLACE / REEMPLAZA:
Scania: 1738098

APPLICATION / APLICACIONE:
Audi: A4 Mk 1 Saloon 1.6/ 1994>200, A6 Mk 1 Saloon 2.0 16V quattro/2.6 quattro/2.8 quattro/S6 Turbo quattro/S6 4.2 quattro/ 1994>1997, A6 Mk 1 Avant/Estate: 2.0 16V quattro/2.8 quattro/S6 Turbo quattro/S6 4.2 quattro/ 1994>1997, Tt Coupe Mk 1: 1.8 T quattro/ 1998>2006, 80 Mk 3 Saloon 2.0/ 1990>1991, 80 Mk 4 Avant/Estate 1.6 E/RS2 quattro/2.3 E quattro/ 1991>1996;

BMW: 3-Series Saloon 316 i/ 1988>1991, 5-Series Saloon 518 i/ 1989>1994, 5-Series Estate 525 td/ 1993>1996, 5-Series Estate 530 d/ 1998>200, 5 525 d/ 2011>2016, 6 Coupe 640 d xDrive/ 2012>2017, X1 xDrive 28 i/ 2011>2015;

Cadillac: Escalade 5.7 AWD/ 1998>2006;

GM: Aveo Hatchback 1.2/1.6/ 2011>, Aveo Saloon 1.2/ 2011>, Camaro Convertible 3.6/ 2011>, Captiva 2.2 D 4WD/ 2011>;

Chrysler: Le Baron Saloon 2.2 i/2.5 i/ 1989>1994, Voyager li 2.5 i/3.3 i AWD/ 1990>1995;

Citroën: C35 Pickup 2.0/ 1973>1994;

Daewoo: Nexia Hatch 1.5 16V (08, 68)/ 1995>1997, Nexia Saloon 1.5 (19)/ 1995>1997;

Daihatsu: Mira Mk 2 Hatch 0.8 4WD (L81)/ 1986>1988, Sirion Mk 2 Hatch 1.3 4WD/ 2005>

GE3098

FEATURES: EVAPORATIVE BOX RESISTENCE

CARACTERÍSTICAS: RESISTENCIA DE LA CAJA EVAPORATIVA

7-WAY CONNECTOR | CONECTOR DE 7 VÍAS
REPLACE / REEMPLAZA:
GM: 52475432, 52484323, 90560362

APPLICATION / APLICACIONE:
Opel: Astra G Hatch 1.2 16V (F08, F48)/1.4 (F08, F48)/1.4 16V (F08, F48)/1.6 (F08, F48)/1.6 16V (F08, F48)/1.8 16V (F08, F48)/2.0 16V (F08, F48)/2.0 16V OPC (F08, F48)/2.0 OPC (F08, F48)/2.2 16V (F08, F48)/1.7 DTI 16V (F08, F48)/1.7 CDTI (F08, F48)/2.0 DI (F08, F48)/2.0 DTI 16V (F08, F48)/2.2 DTI (F08, F48)/ 2000>2009, Astra G Saloon 1.2 16V (F69)/1.4 (F69)/1.4 16V (F69)/1.6 (F69)/1.6 16V (F69)/1.8 16V (F69)/2.0 16V (F69)/2.2 16V (F69)/1.7 DTI 16V (F69)/1.7 CDTI (F69)/2.0 DI (F69)/2.0 DTI 16V (F69)/2.2 DTI (F69)/ 2000>2009, Astra G Estate 1.2 16V (F35)/1.4 16V (F35)/1.6 (F35)/1.6 CNG (F35)/1.6 16V (F35)/1.8 16V (F35)/2.0 16V (F35)/2.0 OPC (F35)/2.2 16V (F35)/1.7 DTI 16V (F35)/1.7 CDTI (F35)/2.0 DI (F35)/2.0 DTI 16V (F35)/2.2 DTI (F35)/ 2000>2004, Astra G Coupe 1.6 16V (F07)/1.8 16V (F07)/2.0 16V Turbo (F07)/2.2 16V (F07)/2.2 DTI (F07)/ 2000>2005, Astra G Convertible 1.6 16V (F67)/1.6 (F67)/1.8 16V (F67)/2.0 OPC (F67)/2.0 16V Turbo (F67)/2.2 16V (F67)/2.2 DTI (F67)/ 2001>2005, Astra G Classic Caravan 1.4 (F35)/ 2007>2009, Astra H Hatch: 1.2 (L48)/1.4 (L48)/1.6 (L48)/1.6 Turbo (L48)/1.8 (L48)/2.0 Turbo (L48)/1.3 CDTI (L48)/1.7 CDTI (L48)/1.9 CDTI (L48)/1.9 CDTI 16V (L48)/ 2004>2014, Astra H Gtc Hatch 1.4 (L08)/1.6 (L08)/1.6 Turbo (L08)/1.8 (L08)/2.0 Turbo (L08)/1.3 CDTI (L08)/1.7 CDTI (L08)/1.9 CDTI (L08)/1.9 CDTI 16V (L08)/ 2005>2010, Astra H Saloon 1.6 (L69)/1.8 (L69)/1.3 CDTI (L69)/1.7 CDTI (L69)/ 2006>2014, Astra H Estate 1.4 (L35)/1.6 (L35)/1.6 Turbo (L35)/1.8 (L35)/2.0 Turbo (L35)/1.3 CDTI (L35)/1.7 CDTI (L35)/1.9 CDTI (L35)/1.9 CDTI 16V (L35)/ 2004>2014, Astra H Convertible 1.6 (L67)/1.6 Turbo (L67)/1.8 (L67)/2.0 Turbo (L67)/1.9 CDTI (L67)/ 2005>2010, Zafira A Mpv 1.6 CNG (F75)/1.6 16V (F75)/1.8 16V (F75)/2.0 OPC (F75)/2.2 16V (F75)/2.0 DI 16V (F75)/2.0 DI (F75)/2.0 DTI 16V (F75)/2.2 DTI 16V (F75)/ 2000>2005

GE3099

FEATURES: EVAPORATIVE BOX RESISTENCE

CARACTERÍSTICAS: RESISTENCIA DE LA CAJA EVAPORATIVA

Resistance / Resistencia: T1 - T2: 1948Ω

Resistance / Resistencia: T1 - T3: 0,919Ω

Resistance / Resistencia: T1 - T4: 0,282Ω

REPLACE / REEMPLAZA:
VW: 30919024

APPLICATION / APLICACIONE:
Audi: 80 Mk 3 Saloon 1.4/1.6/1.8/1.8 S/1.8 S quattro/1.8 E/1.8 E quattro/1.8 quattro/2.0/2.0 quattro/2.0 E/2.0 E quattro/2.0 E 16V/2.0 E 16V quattro/1.6 D/1.6 TD/1.9 D/ 1986>1991, Coupe 1.8/2.0/2.0 16 V/2.0 20 V/2.0 20 V quattro/2.2 quattro/2.3/2.3 quattro/2.3 20V/2.3 20V quattro/2.6/2.6 quattro/2.8/2.8 quattro/ 1988>1996, Cabriolet 2.0 E/2.3 E/2.8/ 1991>1998, 80 Mk 4 Saloon 1.6/1.6 E/2.0/2.0 E/2.0 E quattro/2.0 E 16V/2.0 E 16V quattro/2.3 E/2.3 E quattro/2.6/2.6 quattro/2.8/2.8 quattro/1.9 TD/1.9 TDI/ 1991>1994, 80 Mk 4 Avant/Estate 1.6 E/2.0/2.0 E/2.0 E 16V/2.0 E 16V quattro/S2 quattro/2.3 E/2.3 E quattro/2.6/2.6 quattro/2.8/2.8 quattro/1.9 TD/1.9 TDI/ 1991>1996, 90 Mk 2 Saloon 2.0/2.0 20 V/2.0 20 V quattro/2.2 E/2.2 E quattro/2.3 E/2.3 E quattro/2.3 E 20V/2.3 E 20V quattro/1.6 TD/ 1987>1991;

Seat: Toledo Mk 1 Hatch 1.6 i/1.8 i/1.8 16V/2.0 i/2.0 i 16V/1.9 D/1.9 TD/1.9 TDI/ 1991>1999;

VW: Corrado 1.8 16V/1.8 G60/2.0 i/2.0 i 16V/2.9 VR6/ 1988>1995, Golf Mk 2 Hatch 1.0/1.3/1.3 Cat/1.6/1.8/1.8 Syncro/1.8 i Cat/1.8 GTI/1.8 GTI Cat/1.8 GTI 16V/1.8 GTI G60/1.8 GTI G60 Syncro/1.6 D/1.6 TD/ 1983>1992, Jetta Mk 2 Saloon 1.3/1.3 Cat/1.6/1.8/1.8 Cat/1.8 Syncro/1.8 16V/1.6 D/1.6 TD/ 1984>1992, Passat Mk 3/4 Saloon 1.6/1.8/1.8 16V/1.8 G60 Syncro/2.0/2.0 Syncro/2.0 16V/2.8 VR6/1.6 TD/1.9 D/1.9 TD/ 1988>1996, Passat Mk 3/4 Estate 1.6/1.8/1.8 16V/1.8 G60 Syncro/2.0/2.0 Syncro/2.0 16V/2.8 VR6/1.6 TD/1.9 D/1.9 TD/ 1988>1997

GE3100



FEATURES: EVAPORATIVE BOX RESISTANCE
 CARACTERÍSTICAS: RESISTENCIA DE LA CAJA EVAPORATIVA
 Resistance / Resistencia: T1 - T2: 2,754Ω
 Resistance / Resistencia: T1 - T3: 0,510Ω
 Resistance / Resistencia: T1 - T4: 0,955Ω
 REPLACE / REEMPLAZA:
 Mitsubishi: 246810-5050
 APPLICATION / APLICACIONE:
 Mitsubishi: Pajero 3.8 2003>2014

GE3101



FEATURES: EVAPORATIVE BOX RESISTANCE
 CARACTERÍSTICAS: RESISTENCIA DE LA CAJA EVAPORATIVA
 Resistance / Resistencia: T1 - T2: 3,911Ω
 Resistance / Resistencia: T1 - T3: 2,605Ω
 Resistance / Resistencia: T1 - T4: 5,549Ω
 REPLACE / REEMPLAZA:
 Hyundai: 971282D000
 APPLICATION / APLICACIONE:
 Hyundai: Tucson 2.0/2.7 2004>2012

GE3102



FEATURES: EVAPORATIVE BOX RESISTANCE
 CARACTERÍSTICAS: RESISTENCIA DE LA CAJA EVAPORATIVA
 DIGITAL AIR | AIRE DIGITAL
 MIN. VOLTAGE 1.4 V | VOLTAJE MIN. 1,4 V
 MAX. 2.0 V | MAX. 2,0 V
 4-WAY CONNECTOR | CONECTOR DE 4 VÍAS
 REPLACE / REEMPLAZA:
 Renault: 7710454870
 APPLICATION / APLICACIONE:
 Renault: Master 2.5 2004>2012

GE3103



FEATURES: EVAPORATIVE BOX RESISTANCE
 CARACTERÍSTICAS: RESISTENCIA DE LA CAJA EVAPORATIVA
 MIN. VOLTAGE 1.4 V | VOLTAJE MIN. 1,4 V
 MAX. 2.0 V | MAX. 2,0 V
 5-WAY CONNECTOR | CONECTOR DE 5 VÍAS
 REPLACE / REEMPLAZA:
 Ford: 8E5Z19E624A
 APPLICATION / APLICACIONE:
 Ford: Expedition 2018>;
 Lincoln: MKZ 2007>2012;
 Mercury: Milan 2006>2011

GE3104



FEATURES: EVAPORATIVE BOX RESISTANCE
 CARACTERÍSTICAS: RESISTENCIA DE LA CAJA EVAPORATIVA
 MIN. VOLTAGE 1.0V | VOLTAJE MIN. 1,0 V
 MAX. 9.0V | MAX. 9,0 V
 6-WAY CONNECTOR | CONECTOR DE 6 VÍAS
 REPLACE / REEMPLAZA:
 Renault: 34Z110961257
 APPLICATION / APLICACIONE:
 Renault: Fluence 1.6/2.0 2012>2018

GE3105



FEATURES: EVAPORATIVE BOX RESISTANCE
 CARACTERÍSTICAS: RESISTENCIA DE LA CAJA EVAPORATIVA
 MIN. VOLTAGE 1.0V | VOLTAJE MIN. 1,0 V
 MAX. 4.6V | MAX. 4,6 V
 ELECTRONIC FAN | VENTILADOR ELECTRONICO
 6-WAY CONNECTOR | CONECTOR DE 6 VÍAS
 REPLACE / REEMPLAZA:
 GM: 52488563
 APPLICATION / APLICACIONE:
 GM: Astra 2010>2012

GE3106



FEATURES: EVAPORATIVE BOX RESISTANCE
 CARACTERÍSTICAS: RESISTENCIA DE LA CAJA EVAPORATIVA
 Resistance / Resistencia: T1 - T2: 0,029Ω
 Resistance / Resistencia: T1 - T3: 20,86Ω
 Resistance / Resistencia: T1 - T4: 2,780Ω
 Resistance / Resistencia: T1 - T5: 3,130Ω
 REPLACE / REEMPLAZA:
 GM: 90559834
 APPLICATION / APLICACIONE:

Opel: Astra G Hatch 1.2 16V (F08, F48)/1.4 (F08, F48)/1.4 16V (F08, F48)/1.6 (F08, F48)/1.6 16V (F08, F48)/1.8 16V (F08, F48)/2.0 16V (F08, F48)/2.0 16V OPC (F08, F48)/2.0 OPC (F08, F48)/2.2 16V (F08, F48)/1.7 DTI 16V (F08, F48)/1.7 CDTI (F08, F48)/2.0 DI (F08, F48)/2.0 DTI 16V (F08, F48)/2.2 DTI (F08, F48)/ 2000>2009, Astra G Saloon 1.2 16V (F69)/1.4 (F69)/1.4 16V (F69)/1.6 (F69)/1.6 16V (F69)/1.8 16V (F69)/2.0 16V (F69)/2.2 16V (F69)/1.7 DTI 16V (F69)/1.7 CDTI (F69)/2.0 DI (F69)/2.0 DTI 16V (F69)/2.2 DTI (F69)/ 2000>2009, Astra G Estate 1.2 16V (F35)/1.4 16V (F35)/1.6 (F35)/1.6 CNG (F35)/1.6 16V (F35)/1.8 16V (F35)/2.0 16V (F35)/2.0 OPC (F35)/2.2 16V (F35)/1.7 DTI 16V (F35)/1.7 CDTI (F35)/2.0 DI (F35)/2.0 DTI 16V (F35)/2.2 DTI (F35)/ 2000>2004, Astra G Coupe 1.6 16V (F07)/1.8 16V (F07)/2.0 16V Turbo (F07)/2.2 16V (F07)/2.2 DTI (F07)/ 2000>2005, Astra G Convertible 1.6 16V (F67)/1.6 (F67)/1.8 16V (F67)/2.0 OPC (F67)/2.0 16V Turbo (F67)/2.2 16V (F67)/2.2 DTI (F67)/ 2001>2005, Astra G Classic Caravan 1.4 (F35)/ 2007>2009, Astra H Hatch 1.2 (L48)/1.4 (L48)/1.6 (L48)/1.6 Turbo (L48)/1.8 (L48)/2.0 Turbo (L48)/1.3 CDTI (L48)/1.7 CDTI (L48)/1.9 CDTI (L48)/1.9 CDTI 16V (L48)/ 2004>2014, Astra H Gtc Hatch 1.4 (L08)/1.6 (L08)/1.6 Turbo (L08)/1.8 (L08)/2.0 Turbo (L08)/1.3 CDTI (L08)/1.7 CDTI (L08)/1.9 CDTI (L08)/1.9 CDTI 16V (L08)/ 2005>2010, Astra H Saloon 1.6 (L69)/1.8 (L69)/1.3 CDTI (L69)/1.7 CDTI (L69)/ 2006>2014, Astra H Estate 1.4 (L35)/1.6 (L35)/1.6 Turbo (L35)/1.8 (L35)/2.0 Turbo (L35)/1.3 CDTI (L35)/1.7 CDTI (L35)/1.9 CDTI (L35)/1.9 CDTI 16V (L35)/ 2004>2014, Astra H Convertible 1.6 (L67)/1.6 Turbo (L67)/1.8 (L67)/2.0 Turbo (L67)/1.9 CDTI (L67)/ 2005>2010, Zafira A Mpv 1.6 CNG (F75)/1.6 16V (F75)/1.8 16V (F75)/2.0 OPC (F75)/2.2 16V (F75)/2.0 DI 16V (F75)/2.0 DI (F75)/2.0 DTI 16V (F75)/2.2 DTI 16V (F75)/ 2000>2005

GE3107

FEATURES: EVAPORATIVE BOX RESISTENCE
 CARACTERÍSTICAS: RESISTENCIA DE LA CAJA EVAPORATIVA
 Resistance / Resistencia: T1 - T2: 2,675Ω
 Resistance / Resistencia: T1 - T3: 0,380Ω
 Resistance / Resistencia: T1 - T4: 0,978Ω
 REPLACE / REEMPLAZA:
GM: 90463851
 APPLICATION / APLICACIONE:
Opel: Vectra B Hatch 1.6 i (F68)/ 1995>2003

GE3108

FEATURES: EVAPORATIVE BOX RESISTENCE
 CARACTERÍSTICAS: RESISTENCIA DE LA CAJA EVAPORATIVA
 4R3
 2R8 OHM
 5R8
 TRANSISTORIZED | TRANSISTORIZADO
 3-WAY CONNECTOR | CONECTOR 3 VÍAS
 REPLACE / REEMPLAZA:
Hyundai: 97235-3K000
 APPLICATION / APLICACIONE:
Hyundai: Genesis Coupe 2.0 T/3.8 V6/ 2008>2014, Grandeur 2.7/ 2011>, Ix 55 3.0 V6 CRDi 4WD/ 2011>2012, Sonata Mk 5 2.0 VVTi GLS/2.4/3.3/2.0 CRDi/ 2005>2010, Tucson 2.0/2.0 All-wheel Drive/2.7 All-wheel Drive/2.0 CRDi/2.0 CRDi All-wheel Drive/ 2004>2010;
Kia: Magentis Mk 2 Saloon 2.0/2.7/2.0 CRDi/ 2005>2008, Picanto Mk 1 1.0/1.1/1.1 CRDi/ 2004>, Sportage Mk 2 Suv 2.0 i 16V/2.0 16V 4WD/2.7 V6 4WD/2.0 CRDi 4WD/2.0 CRDi/ 2004>

GE3109

FEATURES: EVAPORATIVE BOX RESISTENCE
 CARACTERÍSTICAS: RESISTENCIA DE LA CAJA EVAPORATIVA
 Resistance / Resistencia: T1 - T2: 5,804Ω
 Resistance / Resistencia: T1 - T3: 3,680Ω
 REPLACE / REEMPLAZA:
Hyundai: 97907-2B000
 APPLICATION / APLICACIONE:
Hyundai: Santa Fé 2.4/2.0 CRDi/2.0 CRDi 4x4/ 2010>2012

GE3110

FEATURES: EVAPORATIVE BOX RESISTENCE
 CARACTERÍSTICAS: RESISTENCIA DE LA CAJA EVAPORATIVA
 REAR AIR | AIRE TRASERO
 6R60
 2R5 OHM
 4-WAY CONNECTOR | CONECTOR DE 4 VÍAS
 REPLACE / REEMPLAZA:
Kia: 971791F210; **Meat & Doria:** K109182
 APPLICATION / APLICACIONE:
Hyundai: Tucson 2.0/2.0 All-wheel Drive/2.7 All-wheel Drive/2.0 CRDi/2.0 CRDi All-wheel Drive/ 2004>2010;
Kia: Carens Mk 3 2.0 CVVT/2.0 CRDi 115/2.0 CRDi 140/ 2006>, Sedona Mk 3 2.7 V6/2.9 CRDi/ 2006>, Rio Mk 2 Saloon 1.4 16V/1.5 CRDi/1.6 CVVT/ 2005>, Rio Mk 2 Saloon 1.4 16V/1.6 16V/1.5 CRDi/ 2005>, Sorento Mk 1 Suv 2.4/3.5 V6 4WD/2.5 CRDi/ 2002>, Sportage Mk 2 Suv 2.0 i 16V/2.0 16V 4WD/2.7 V6 4WD/2.0 CRDi/2.0 CRDi 4WD/ 2004>

GE3111

FEATURES: EVAPORATIVE BOX RESISTENCE
 CARACTERÍSTICAS: RESISTENCIA DE LA CAJA EVAPORATIVA
 4R2
 3R2 OHM
 5R8
 4-WAY CONNECTOR | CONECTOR DE 4 VÍAS
 REPLACE / REEMPLAZA:
Kia: 971792 J000
 APPLICATION / APLICACIONE:
Hyundai: Genesis Coupe 2.0 T/3.8 V6/ 2008>2014, I20 1.4 CRDi/ 2008>2012, Ix 35 1.6/1.7 CRDi/2.0 CRDi/ 2010>, I40 Cw 1.6 GDI/2.0 GDI/1.7 CRDi/ 2011>, Veloster 1.6 GDI/ 2011>2017;
Kia: Rio Iii 1.25 CVVT/ 2011>, Sorento Ii 2.0 CRDi/2.0 CRDi 4WD/ 2010>, Sportage 1.6 GDI/1.7 CRDi/2.0 CRDi/2.0 CRDi AWD/ 2010>

GE3112

FEATURES: EVAPORATIVE BOX RESISTENCE
 CARACTERÍSTICAS: RESISTENCIA DE LA CAJA EVAPORATIVA
 0R44
 0R89 OHM
 3R03
 CONNECTORS 12/2 / WHIP 2 WAYS | CONECTORES 12/2 / WHIP 2 VÍAS
 REPLACE / REEMPLAZA:
Renault: 7701067033
 APPLICATION / APLICACIONE:
Renault: Clio 1.0/1.6 2000.2009

GE3113

FEATURES: EVAPORATIVE BOX RESISTENCE
 CARACTERÍSTICAS: RESISTENCIA DE LA CAJA EVAPORATIVA
 0R34
 0R97 OHM
 3R01
 REPLACE / REEMPLAZA:
 ...
 APPLICATION / APLICACIONE:
Hyundai: Hb20 1.0/1.6 2012>2013



EQUIPMENT | EQUIPO DE TESTE

FUEL PUMP TESTER | PROBADOR DE BOMBA DE COMBUSTIBLE

TP001
FEATURES / CARACTERÍSTICAS:

Voltage | Voltaje: 5 – 15VDC | **Current | Corriente:** 0 – 15ADC | **Pressure | Presión:** 0 – 1,6MPa (0 – 230psi) | **Flow | Fluir:** 25 – 250 l/h
Temperature | Temperatura: 25 ±10°C
Power Voltage | Power Voltage: 100-120VAC/200-240VAC
Power | Potencia: 747,5W (115VAC 6,5A) / 880W (220VAC 4,0A)
Power Frequency | Frecuencia de Potencia: 50Hz/60Hz
Height | Altura: 61cm - **Width | Anchura:** 42cm - **Length | Longitud:** 36cm

AX001
FEATURES / CARACTERÍSTICAS:

Short Circuit Tester. Emits a tone when inserted on a fuse holder. Helpson finding short circuit between wires and ground.
Probador de cortocircuito. Emite un tono cuando se inserta en un portafusibles. Ayuda a encontrar cortocircuito entre cables y tierra.

POLARITY TESTER | PRUEBA DE POLARIDAD

AX002N
FEATURES / CARACTERÍSTICAS:

Front LED provides light | Two LEDs for polarity indicator | 194cm cable length | Protect cover | Two Alligator Clips.
LED frontal proporciona luz | Dos LED para indicador de polaridad | Longitud del cable de 194 cm | Proteger la cubierta | Dos pinzas de cocodrilo

POLARITY TESTER | PRUEBA DE POLARIDAD

AX003
FEATURES / CARACTERÍSTICAS:

Front LED provides light | Two LEDs for polarity indicator | 5m cable length | Protect cover | Two Alligator Clips.
LED frontal proporciona luz | Dos LED para indicador de polaridad | Longitud del cable de 5 m | Proteger la cubierta | Dos pinzas de cocodrilo

AUTOPARTS TESTER | PRUEBA DE AUTOPARTES

BT010 // NEW //
FEATURES / CARACTERÍSTICAS:

Measures: 44 (L) X 36 (P) X 16 (A) cm
Gross Weight Approx: 11,5 Kg
Net Weight Approx: 9,4 Kg
Voltage (V): 127V / 220V (Selectable Switch)

BENCH TEST | BANCO DE PRUEBAS

BT500
FEATURES / CARACTERÍSTICAS:

Load Capacity | Capacidad de carga: 75A @ 28V / 10 sec or 140A @ 14V / 5 sec
Ammeter | Amperímetro: Maximum capacity 199,9A
Voltmeter | Voltímetro: Maximun reading 199,9V ± 0,5%
Voltage | Voltaje: 110 / 220V Monophasic / Biphasic
Motor Power | Fuerza de motor: 3 CV
Height | Altura: 1,14m - **Width | Anchura:** 0,538m - **Length | Longitud:** 0,755m
Weight | Peso (approx.): Net: 85 Kg - **Gross | Bruto:** 116 Kg

BENCH TEST | BANCO DE PRUEBAS

BT200
FEATURES / CARACTERÍSTICAS:

Load Capacity | Capacidad de carga: 75A @ 28V / 10 sec or 140A @ 14V / 5 sec
Ammeter | Amperímetro: Maximum capacity 199,9A
Voltmeter | Voltímetro: Maximun reading 199,9V ± 0,5%
Voltage | Voltaje: 110 / 220V Monophasic / Biphasic
Motor Power | Fuerza de motor: 3 CV
Height | Altura: 415mm - **Width | Anchura:** 570mm - **Length | Longitud:** 570mm
Weight | Peso (approx.): Net: 55,1 Kg - **Gross | Bruto:** 61,75 Kg

VOLT-AMPERIMETER | VOLT-AMPERÍMETRO

VA600
FEATURES / CARACTERÍSTICAS:

With Load simulator. Con simulador de carga
Voltage Range | Distancia de Voltaje: 0 - 30V | **Current Range | Distancia de Corriente:** 0 - 150A
Electrical Current Measuring with Electromagnetic clamp. Medición de corriente eléctrica con pinza electromagnética
Carbon Pyle Load | Carga de Pyle de Carbono: 150A @ 14V/10s / 100A @ 28V/10s
Height | Altura: 160mm - **Width | Anchura:** 290mm - **Length | Longitud:** 210mm